

DEVERBAL NOMINALS IN XHOSA

BY

LOYISO KEVIN MLETSHE

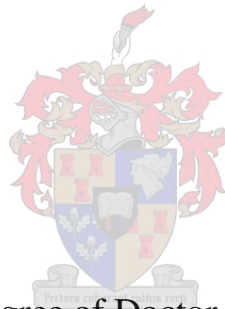

Dissertation presented for the degree of Doctor of Philosophy (African Languages) at Stellenbosch University

Supervisor: Prof M.W. Visser

DECEMBER 2010

DECLARATION

By submitting this dissertation electronically, I declare that the entirety of the work contained therein is my own, original work, that I am the owner of the copyright thereof (unless to the extent explicitly otherwise stated) and that I have not previously in its entirety or in part submitted it for obtaining any qualification.

Date: November 2010

ABSTRACT

The relationship between deverbative noun classification and their effect on the semantic meaning of the derived deverbal nominal has been the focus of many studies in linguistics, with special reference to African languages in recent years. The study maintains that the descriptive analysis of deverbal nominals in African languages does not fully interrogate the predicate argument structures of the verbs that host these deverbal nominals. This thesis is an investigation of how the syntactic properties of verbs from which deverbal nouns are derived are invoked in explaining the argument structure and event structure properties of deverbal nouns, particularly in Xhosa. The analysis presented here is situated in terms of a lexical semantic representation drawing on Pustejovsky (1996) and Busa (1996), which aims to capture linguistically relevant components of meaning.

Chapter 1 presents the purpose and aims of the study, and states the theoretical paradigm on which this study is couched, namely Pustejovsky's (1996) generative lexicon theory as well as the methodology for conducting the research.

Chapter 2 contains a literature review on deverbal nominals in African languages. This chapter explores the general definitions of concepts, the descriptive nature of deverbal nominals from various African languages, noun classification and the morphology of African nouns.

Chapter 3 reports on an examination of the generative lexicon theory. This theory contains multiple levels of representation for different types of lexical information required, namely the argument structure, the event structure, the qualia structure and the lexical inherent structure. For the purposes of this study, the first three levels of representation were used for analysis.

Chapter 4 contains the systematic classification of deverbal nominals that are derived from various semantic verb classes and are considered under their derivation from intransitive, transitive and di-transitive verbs, respectively. The first lexical schematic representation for each verb class gives a classification of various deverbal noun classes 1, 3, 5, 7, 8, 9, 11 and 14 in instances where the noun class applies. The second schematic representation details how these various verb classes are classified/categorised in terms of their semantic type. There are

various noun class nominalisations for each verb class, which serve as a representative for each group of the various verb classes.

Chapter 5 provides a detailed analysis of various deverbal nouns derived from different verb classes utilising the generative lexicon theory as a source of reference, particularly the first three levels of representation. The compositionality and the semanticity of derived nominals within the predicate argument structures are demonstrated.

Chapter 6 summarises the findings of all previous chapters in this study.

OPSOMMING

Die verhouding tussen die klassifikasie van deverbatiwe selfstandige naamwoorde en hul uitwerking op die semantiese betekenis van die afgeleide deverbatiwe nominaal was die fokus van talle studies in linguistiek, met spesiale verwysing na Afrikatale in die afgelope jare. Hierdie studie doen aan die hand dat die deskriptiewe analise van deverbatiwe nominale in Afrikatale nie die predikaat-argumentstrukture van die werkwoorde wat hierdie deverbatiwe nominale bevat, ondersoek nie. Die tesis behels 'n ondersoek na die manier waarop die sintaktiese eienskappe van werkwoorde waaruit deverbatiwe selfstandige naamwoorde afgelei word, aangewend word om die argumentstruktuur- en gebeurestruktuureienskappe van deverbatiwe selfstandige naamwoorde, veral in Xhosa, te verklaar. Die analise is gegrond op 'n leksikaal-semantiese ontleding aan Pustejovsky (1996) en Busa (1996), met die doel om linguisties toepaslike betekenis-komponente vas te lê.

In hoofstuk 1 word die doel en doelstellings van die studie uiteengesit, asook die teoretiese paradigma waarop die studie berus, naamlik Pustejovsky (1996) se generatieweleksikon-teorie. Die navorsingsmetodologie word ook in hierdie hoofstuk uiteengesit.

Hoofstuk 2 bevat 'n literatuuroorsig oor deverbatiwe nominale in Afrikatale. In hierdie hoofstuk word ondersoek ingestel na die algemene definisies van konsepte, die beskrywende aard van deverbatiwe nominale in verskeie Afrikatale, die klassifikasie van selfstandige naamwoorde asook die morfologie van selfstandige naamwoorde in Afrikatale.

In hoofstuk 3 word verslag gedoen oor die ondersoek van die generatieweleksikon-teorie. Hierdie teorie bevat veelvuldige vlakke van verteenwoordiging vir verskillende soorte leksikale inligting wat vereis word, naamlik die argumentstruktuur, die gebeurestruktuur, die qualiastruktuur en die leksikaal-inherente struktuur. Vir die doel van hierdie studie is op die eerste drie vlakke van verteenwoordiging tydens die analise gefokus.

Hoofstuk 4 bevat die stelselmatige klassifikasie van deverbatiwe nominale wat uit verskeie semantiese werkwoordklasse afkomstig is, en oorweging geniet op grond van hul afstamming van onderskeidelik intransitiwe, transitiwe en ditransitiwe werkwoorde. Die eerste leksikaal-skematiese verteenwoordiging vir elke werkwoordklas gee 'n klassifikasie van verskeie klasse van deverbatiwe selfstandige naamwoorde, naamlik 1, 3, 5, 7, 8, 9, 11 en 14, in gevalle waar die selfstandigenaamwoordklas van toepassing is. Die tweede skematiese

verteenwoordiging sit uiteen hoe hierdie verskillende werkwoordklasse in terme van hul semantiese soort geklassifiseer/gekategoriseer word. Daar is verskeie nominaliserings vir selfstandigenaamwoordklasse vir elke werkwoordklas, wat as 'n verteenwoordiging vir elke groep van die onderskeie werkwoordklasse dien.

Hoofstuk 5 bevat 'n gedetailleerde analise van verskeie deverbative selfstandige naamwoorde wat uit verskillende werkwoordklasse afgelei is met behulp van die generatieweleksikon-teorie as 'n verwysingsbron, spesifiek die eerste drie vlakke van verteenwoordiging. Die samestelling en semantiek van afgeleide nominale in die predikaatargument-strukture word ten toon gestel.

Hoofstuk 6 bevat 'n opsomming van die bevindinge in die voorafgaande hoofstukke.

ACKNOWLEDGEMENTS

To my supervisor, Prof M.W. Visser, I doubt I will ever be able to show how grateful I really am for her constant supervision in making this study a success. Her wise counsel, wisdom and encyclopedic knowledge of the field of linguistics were instrumental in the completion of this dissertation. It is really true that diamond comes in small packages. It is with a profound sense of humility that I say to my supervisor, ENKOSI.

To the staff of the African Languages Department, Stellenbosch University, you made my stay there during my study leave as comfortable as ever, for that, I thank you. Thanks are also due to Dr M. Dlali for his constant encouragement throughout the year I was busy with my writing. I cannot forget to shower with appreciation the pulse of the African Languages Department, Mrs Surena Du Plessis, for all her assistance and for synchronizing this work into what it is.

The University of the Western Cape deserves my gratitude for facilitating my study leave. Had it not been for the relief from my daily lectures, the writing of my dissertation would have been mission impossible. I would also like to thank my uncle, Mr A.B Stuurman, who was the first person to sow the seed in me to pursue studies at university. He nurtured me throughout my secondary and university education to be what I am today. Lume, the seed has germinated.

To my children, Luthando, Zintle and Loyiso Junior, who was born during the critical time of my writing of this dissertation and saw very little me as I was focusing on my writings. I am truly sorry for spending less time with you. I hope that one day you will understand why you saw little of me at times.

Last but by no means least, throughout the writing of this dissertation my wife, Ntombodidi, MaMceche, without whom this effort would have been worth nothing has been unwavering in her support, as she unselfishly took care of our children, became the source of my support and strength. For that mfazi wakwaRhadebe, I owe you my deepest gratitude. Ikhazi lakwaRhadebe alilahlekanga apha kuwe.

DEDICATION

I dedicate this dissertation to my children Luthando, Zintle and Loyiso Junior.

TABLE OF CONTENTS

DECLARATION	ii
ABSTRACT	iii
OPSOMMING	v
ACKNOWLEDGEMENTS	vii
DEDICATION	viii

CHAPTER 1: INTRODUCTION

1.1	Purpose and aims of the study	1
1.2	Theoretical framework and methodology	2
1.3	Organisation of the study	2

CHAPTER 2: PREVIOUS RESEARCH ON DEVERBAL NOMINALS

2.1	Introduction	4
2.2	The general definition of concepts	5
2.3	The descriptive nature of deverbals	18
2.3.1	The derivation of nouns in Zulu	19
2.3.2	The morphology of Siswati deverbals	22
2.3.3	The derivation of Venda deverbals	23
2.3.4	The morphology of Setswana deverbals	25
2.3.5	The deverbals of Northern Sotho	30
2.3.6	The deverbals of Tsonga	31
2.4	Noun classification	33
2.4.1	The semantic reality of Bantu noun classes: The Kikuyu case	33
2.4.2	The semantics of noun classes in Proto-Bantu	37
2.4.3	Maa (Maasai) Nominalization: Animacy, Agentivity and Instrument	41
2.4.4	Moro noun class morphology	42
2.4.5	Noun class prefixes: Inflectional or derivational	44
2.4.6	Bantu class prefixes: Inflectional or derivational?	46
2.4.7	The semantics of Bantu noun classification	49
2.5	Bantu noun morphology	52
2.5.1	History of noun classification	53
2.5.2	Concord	54

2.5.3	Gender conflict resolution	55
2.5.4	Semantics of noun classes	57
2.6	Conclusion	58

CHAPTER 3: THE GENERATIVE LEXICON THEORY

3.1	Introduction	60
3.2	The nature of lexical knowledge	62
3.2.1	Verbal alternations.....	63
3.2.2	Nominal alternations.....	67
3.2.3	The logical problem of polysemy	69
3.2.4	The logical problem of polysemy	70
3.3	The goals of lexical semantic theory	75
3.3.1	The creative use of words.....	76
3.3.2	Generative lexical models	79
3.3.2.1	The argument structure	81
3.3.2.2	Extended event structure	84
3.3.3	The Qualia structure of nominals	92
3.3.3.1	Mapping from qualia	97
3.4	The Semantics of nominals.....	99
3.4.1	Nominals with unified types.....	100
3.4.2	Nominals with complex types	105
3.4.3	Varieties of nominalization	109
3.4.3.1	The contribution Generative Lexicon Theory (GL-theory) to the study of nominalization	118
3.5	Individual-level and Stage-level Deverbal nouns: Event structure properties	120
3.5.1	The aspectual structure of verb meanings	120
3.5.2	Stage-Level and Individual-Level Predicates.....	124
3.5.2.1	Distinction within the set of individual-level nominals.....	127
3.5.2.2	Distinction within the set of stage-level nominals.....	148
3.6	Conclusion.....	161

CHAPTER 4: A SYSTEMATIC INVESTIGATION OF DEVERBAL NOMINALS

4.1	Introduction	163
-----	--------------------	-----

4.2	Intransitive verbs	163
4.2.1	State verbs.....	163
4.2.2	Motion verbs.....	170
4.2.3	Verbs relating to the body (Bodily processes).....	176
4.2.4	Experiencer verbs	200
4.2.5	Weather verbs	216
4.2.6	Motion verbs with a locative argument	220
4.2.6.1	The locative refers to a location	220
4.2.6.2	The locative refers to source.....	229
4.2.6.3	The locative refers to direction	237
4.3	Transitive verbs	241
4.3.1	Verbs of change of state	241
4.3.2	Verbs of creation	250
4.3.3	Verbs of perception	264
4.3.4	Search verbs.....	275
4.3.5	Verbs of ingesting / consumption.....	283
4.3.6	Verbs of cognition	292
4.3.7	Verbs of contact.....	304
4.3.8	Communication verbs.....	321
4.3.9	Put verbs with a locative argument.....	338
4.3.10	Remove verbs with a locative argument.....	351
4.4	Ditransitive verbs.....	360
4.4.1	Change of possession verbs	360
4.5	Conclusion	367

CHAPTER 5: A GENERATIVE LEXICON THEORETICAL ANALYSIS OF DEVERBAL NOMINALS

5.1	Introduction	368
5.2	Intransitive verbs	370
5.2.1	State verbs.....	370
5.2.2	Motion verbs.....	381
5.2.3	Verbs relating to the body (Bodily processes).....	392
5.2.4	Experiencer verbs	403
5.2.5	Weather verbs	411

5.2.6	Motion verbs with a locative argument	419
5.2.6.1	The locative refers to a location	419
5.2.6.2	The locative refers to source.....	431
5.2.6.3	The locative refers to direction.....	442
5.3	Transitive verbs	453
5.3.1	Verbs of change of state	453
5.3.2	Verbs of creation	464
5.3.3	Verbs of perception	477
5.3.4	Search verbs.....	489
5.3.5	Verbs of ingesting / consumption.....	500
5.3.6	Verbs of cognition	511
5.3.7	Verbs of contact.....	523
5.3.8	Communication verbs.....	536
5.3.9	Put verbs with a locative argument.....	550
5.3.10	Remove verbs with a locative argument.....	561
5.4	Ditransitive verbs.....	574
5.4.1	Change of possession verbs.....	574
5.5	Conclusion.....	586
 CHAPTER 6: CONCLUSION		
6.1	Review of the study	589
6.2	A comparative view of nominal derivations across verb classes	595
6.3	Insights for further significant research.....	598
 REFERENCES		600

CHAPTER 1

INTRODUCTION

1.1 PURPOSE AND AIMS OF THE STUDY

The purpose and aims of this study is to explore the deverbal nominals in Xhosa within the Generative Lexicon Theory (Pustejovsky1996). Previous studies in African languages, like Xhosa, have largely investigated deverbal nominals from a descriptive perspective. The descriptive perspective succeeds in accounting for the semantics of deverbal nouns displayed in the lexicon but fall short to satisfactorily clarify the semantics of those structures that go beyond the realm of rudimentary meaning.

A prominent issue addressed cross-linguistically in current research on lexical semantics relates to the argument structure event structure properties of deverbal nominals in relation to their analogous verbs. It is on this basis that I utilize the Generative Theoretical paradigm as it encapsulates lexical meaning by dividing lexical information into four different levels of representation, namely *argument structure*, *qualia structure*, *event structure* and *lexical inheritance structure*. In this study, I will focus on three levels of representation, the argument structure, event structure and qualia structure. The central assumption within the Generative Lexicon theory is that the lexicon is an essential and coherent component of linguistic knowledge, which provides insights on how word meaning interacts with a set of generative mechanisms to account for the creative use of language (Busa 1996).

Thus, this dissertation can contribute to the current theoretical and empirical insights on deverbal nominals through the evidence presented from Xhosa as an African language from Southern Africa. It can also be considered as a contribution for other fields of linguistic research, especially, lexicography and lexicology. The researchers of Xhosa lexicography and lexicology require an understanding of basic research in lexical semantics in addition to the morpho-syntactic behavior of lexical items. They will find the theoretical analysis of deverbal nominals quite fulfilling and, hence, they can draw from it on how to handle other linguistic forms that require meaning. Thus, this study, therefore, will in some way help fill the existing literature gap in this area.

1.2 THEORETICAL FRAMEWORK AND METHODOLOGY

The general theoretical paradigm assumed in this study is the theoretical framework of Generative Lexicon Theory as outlined in Pustejovsky (1996). Pustejovsky's Generative Lexicon model is intended to deal with creative uses of language, particularly the issue of polysemy. It also accounts for word meaning and for meaning of words in compositionality. The rationale relating to the theoretical component in this study is concerned with extending and refining specific principles and mechanisms developed within the framework of Generative Lexicon Theory. This objective will be accomplished by exploring a specific set of Xhosa data, relating to the semantics and syntax of deverbatives in Xhosa. The analysis process of the data is very systematic as for each verb class there is an analysis of the derived deverbal nominal with its corresponding verb.

This study employs a combination of methods to achieve its objectives. It uses qualitative methods (i.e. analytical descriptive) where it analyzes descriptive perspectives on deverbal nominals in African languages. The study also systematically provides a data of various verb classes that have been divided into intransitive verbs, transitive verbs and ditransitive verbs. These verbs have been divided into various verb classes. These verb classes have been further sub-categorized according to noun classes 1, 3, 5, 6, 7/8, 9, 11 and 14. This study has also utilized the quantitative method in the compilation of data so as to establish empirical validity and systematicity. Thus, data collection has been gathered from Xhosa literature, Xhosa speakers and the rest of the data is based on my own intuition.

1.3 ORGANISATION OF THE STUDY

The study is organized into six chapters in the following manner:

Chapter One: This chapter consists of the introduction, stating the purpose and theoretical framework, method and organization of the study.

Chapter Two: This chapter examines literature review of previous descriptive studies on deverbal nouns in Xhosa and related African languages.

Chapter Three: This chapter provides a synopsis of literature review of recent research within the paradigm of the Generative Lexicon Theory.

Chapter Four: This chapter consists of a systematic investigation of deverbal nominals derived from intransitive verbs, transitive verbs and ditransitive verbs. The various verb classes are schematically shown followed according to various noun classes.

Chapter Five: This chapter investigates the distinction in complement taking behaviour of various deverbal nouns derived from various verb classes, particularly the lexical semantic representation wherein the argument structure, event structure and and qualia structure are analyzed. This chapter overlaps with chapter 4 where all these various verb classes have been described.

Chapter Six: This chapter provides the summary of the main findings of the study, conclusions and insights for further research.

CHAPTER 2

PREVIOUS RESEARCH ON DEVERBAL NOMINALS

2.1 INTRODUCTION

This chapter affords the researcher latitude to investigate various ways of determining the nature of deverbal nominals in African languages, thereby, contributing in establishing a correlation with the topic of this thesis, THE DEVERBAL NOMINALS IN XHOSA. The derivation of nouns in African languages has always revolved around the changing of verbs into nouns, and the issue of noun classes, as specified by Burton and Kirk (1976), Du Plessis (1997), Poulos (1990), Poulos and Louwrence (1994), Poulos and Msimang (1998), Gibbard et al (2009), and Brindle (2009), among many linguists. This phenomenon has also received attention from Ziervogel and Mabuza (1976) as they suggested that deverbatives are derived through a process of prefixation and suffixation, commonly known as deverbative noun classification..

The issue of deverbative noun classification has in many instances led to the examination of the noun class prefixes so as to determine their characteristic semantic meaning. Denny and Creider (1986) acknowledged the claim that Proto-Bantu noun prefixes realizes a semantic system where each prefix is associated with a characteristic meaning, a notion espoused by Contini-Morava (1997), Katamba (2003), Krüger (2006), Dingemanse (2000), and Payne and Olsen (2009), among others.

Mufwene (1980: 247) remarked that Bantu noun classes have been attributed a number inflectional roles, and that these noun classes entail derivational processes, a notion supported by Baumbach (1987), Schaderberg (2000). Payne and Olsen (2009) claim that the Maa nominalizers have a range of meanings which pertain to the lexical aspect, animacy, and semantic role. Gibbard et al (2009: 111) addresses the uncertainty as to whether the initial vowel constitutes a prefix or whether the vowel is part of the root. This chapter explores these issues so as to show the descriptive nature of previous research that has characterized research on deverbal nominals in the African languages, especially the Southern African languages related to IsiXhosa. In chapter 5 of this research, various noun class prefixes of different deverbal nominals derived from a range of verb classes are examined in greater detail so as to determine the appropriate characteristic semantic meaning of each deverbal nominal. This is

done by utilizing Pustejovsky's (1995, 1996) Generative Lexicon Theoretical framework as it provides the devices that can handle intricate linguistic distinctions.

This chapter is organized into six sections: section 2.1 contains the introduction, section 2.2 will explore the general definitions of concepts, and section 2.3 will investigate the descriptive nature of deverbal nominals from various African languages, section 2.4 will explore noun classification, and section 2.5 will examine the morphology of Bantu nouns, followed by the concluding remarks in section 2.6.

2.2 THE GENERAL DEFINITION OF CONCEPTS

The objective of this section is to discuss the general definitions of linguistic concepts that are fundamental for the purposes of this study. The first concept that is described is a familiar yet misunderstood concept, the **word**. Plag (1998: 8) is of the view that words are syntactic atoms, i.e. the smallest elements in a sentence, and that they belong to certain syntactic classes (nouns, verbs, adjectives, prepositions etc.), which are parts of speech, word classes, or syntactic category.

Katamba and Stonham (2006: 17) are of the view that a word can be defined in terms of a lexeme which is an abstract vocabulary item, as in **kick**. A lexeme can have different realisations or manifestations, as is illustrated in **kicking**, **kick**, **kicks** and **kicked**. The physical realizations of a lexeme in speech or writing is termed its word form, according to Katamba and Stonham. The morphosyntactic properties of a word are realised as nouns, adjectives, verbs, tenses, gender and number, and the categorical specification of a word is referred to as a grammatical word by Katamba and Stonham. It is against this backdrop that the word form *cut* can be represented into the following grammatical form:

1. (a) **cut** [verb, present,, non-3rd person singular]
- (b) **cut** [verb, past]
- (c) **cut** [noun, singular]

Katamba and Stonham (2006: 17) postulate that the smallest, indivisible unit of a semantic content or grammatical function from which words are made up is a **morpheme**. The

morpheme *un-* in *uncle* and *under* has no identifiable or grammatical or semantic value because *-cle* and *-der* on their own do not mean anything, according to Katamba and Stonham. It is for this reason that Katamba and Stonham cite Aronoff (1976) who argued that it is the word in its entirety rather than the morpheme that must be meaningful.

Katamba and Stonham argue that the analysis of words into morphemes begins with the isolation of morphs, by determining a contrast in terms of: (i) the phonological shape due to the sounds used; (ii) meaning, defined to cover both lexical meaning and grammatical function. A **morph** is defined as a physical form that represents a morpheme in a language, according to Katamba and Stonham. The examples in (2) illustrate this notion.

2. Morph
- (a) /ðə/ ‘the’
- (b) /kɑ/ ‘car’
- (c) /pɑ:k/ ‘park’

Katamba and Stonham (2006: 26) indicate that if different morphs that are grouped together represent the same morpheme, they are referred to as **allomorphs** of the same morpheme (i.e. when they are in complementary distribution). The relationship between morphemes, allomorphs and morphs can be represented as in (3).

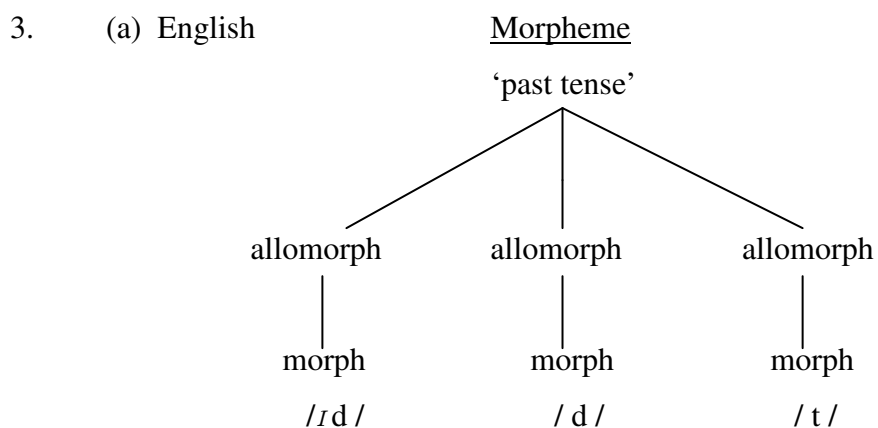

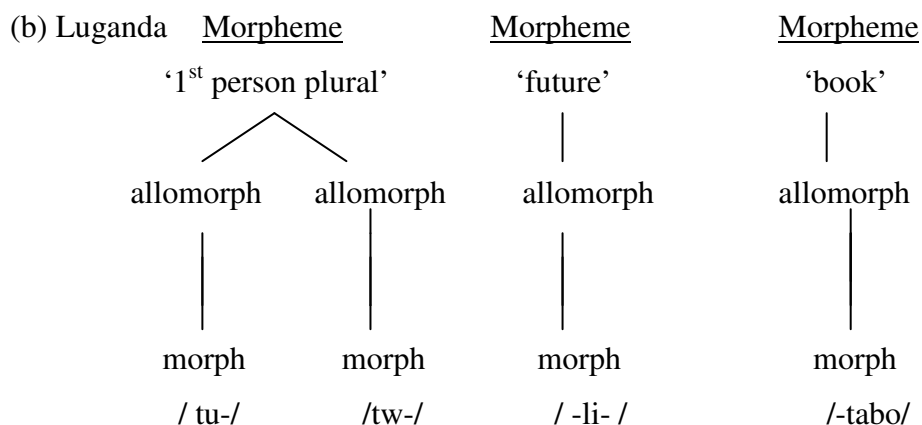

Katamba and Stonham (2006) state that the distribution of allomorphs is, normally, **phonologically conditioned**, but sometimes, may be **grammatically conditioned**, that is, it may be dependent on the presence of a particular grammatical element, or **lexically conditioned**, its use may be obligatory if a certain word is present, as is illustrated in (4 & 5) respectively.

4. Grammatically conditioned

	<u>Present tense</u>	<u>Past tense</u>
(a)	walk /wɔ:k/	walked /wɔ:kt/
	kiss /kis/	kissed /kist/
(b)	weep /wi:p/	wep-t /wept/
	sweep /swi:p/	swep-t /swept/
(c)	shake /ʃeik/	shook /ʃ uk/
	take /teik/	took /tuk/

5. Lexically conditioned

	<u>with allomorph /-iz/</u>		
(a)	asses	mazes	beaches
	/ æsis /	/meiziz/	/bi:tʃiz/
	<u>with allomorph /-s /</u>		
(b)	cups	leeks	carts
	/kʌps/	/li:ks/	/kɑ:ts/

	<u>with allomorph / -z /</u>		
(c)	bards	rooms	shoes
	/bɑ:dz/	/ru:mz/	/ʃu:z/

The third distribution of allomorphs is referred to as **suppletion**. Katamba and Stonham (2006: 30) define suppletion as morphemes whose allomorphs show no phonetic similarity, as is shown in (6).

6.	(a)	good	better
	(b)	bad	worse

According to Katamba and Stonham (2006) morphemes consist of roots, affixes, stems and bases, and they define a **root** as the irreducible core of a word. They further state that roots can be divided into two types. First, under free morphemes, that is, roots which are capable of standing on their own, and carry a semantic content, they identify as lexical morphemes. There is another class of free morphemes called function words, whose task is to signal grammatical information or logical relations in a sentence. Secondly, the bound morphemes, are roots which are incapable of occurring in isolation, according to Katamba and Stonham. Plag (1998: 10) contends that some bound morpheme, for example **un-**, must always be attached before central meaningful element of the word, such as root, stem, or base, whereas other bound morphemes, such as **-ity**, **-ness**, or **-less**, must follow the root. The root can be represented as in (7) .

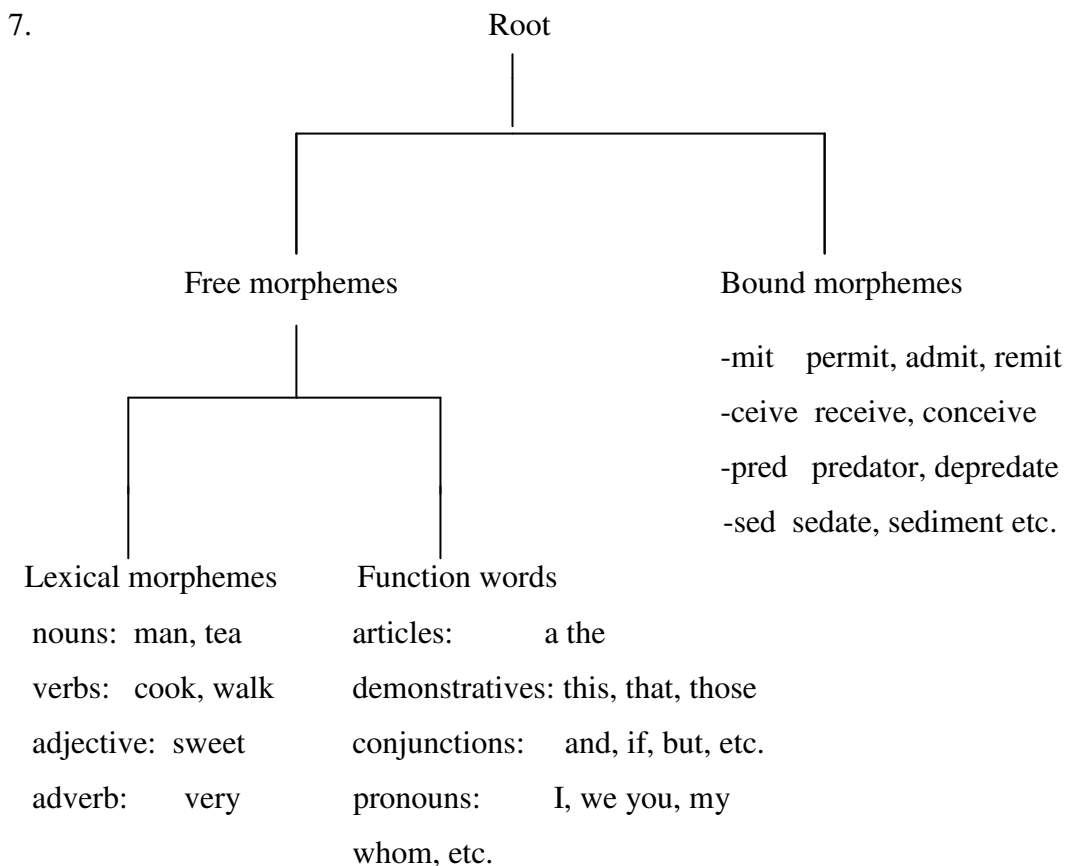

The second type of a morpheme is an affix, according to Katamba and Stonham (2006). They specify that an **affix** is a morpheme that occurs when attached to some other morpheme or morphemes such as a root or stem or base, and as such are bound morphemes. There are basically three types of affixes, and can be represented as in (8).

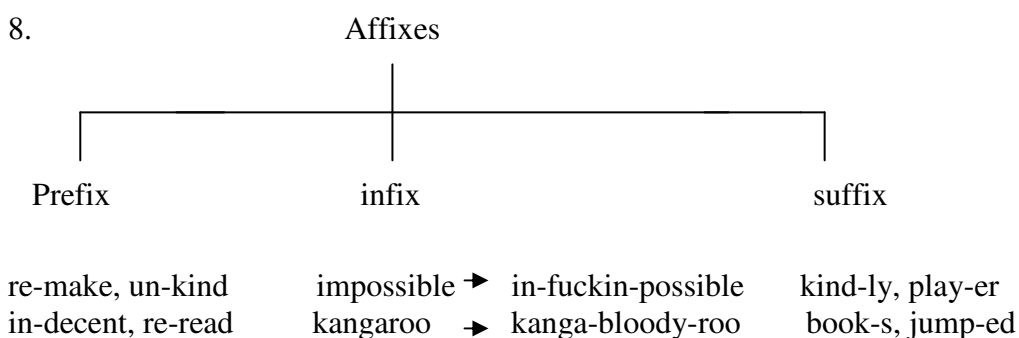

The third one is the **stem**, it is that part of the word that is in existence before any inflectional affixes have been added, according to Katamba and Stonham. The examples in (9) indicate stems.

9.	<u>Noun stem</u>	<u>Plural suffix</u>
(a)	cat	-s
(b)	worker	-s
(c)	ball	-s

The fourth is a **base** which is defined as any unit to which affixes of any kind, be they inflectional or derivational, can be attached to, according to Katamba and Stonham, as is shown in (10).

10.	<u>Base</u>	<u>Affix</u>
(a)	boy	-s
(b)	boy	-ish

The other important concepts discussed by Katamba and Stonham relate to, productivity and creativity in word-formation. They equate the term productivity to creativity, that is, the capacity of all human languages to use finite means to produce an infinite number of words and utterances. They specify that creativity manifests itself in two distinct ways: rule-governed creativity and rule-bending creativity.

Plag (1998: 14) provides a crucial difference between inflection and derivation by stating that, an inflectional morphemes encode grammatical categories such as plural (workers), person (works), tense (picked), or case (John's). Plag further argues that the plural and person suffixes are relevant for the syntax in inflection, whereas, the contrary is true for derivation, as it is not relevant for syntax. He further points out that inflectional suffixes do not change the category of the base word, whereas, all derivational affixes are category-changing, as is evidenced, for example, by most prefixes, as in (11).

11.	(a)	post-war
	(b)	decolonialize
	(c)	non-issue
	(d)	terrorism

Plag further elaborates that derivation is often semantically opaque or non transparent, i.e., the meaning of the derived word cannot be inferred on the basis of its constituent morphemes, as

can be exemplified by the two derivatives *interview* and *curiosity*. He specifies that the meaning of *inter-* can be paraphrased as ‘between,’ that of (the verb) *view* as look at something (definition according to the Longman Dictionary of Contemporary English), whereas the meaning of (the verb) *interview* is ‘to ask someone questions, especially in a formal meeting.’ The meaning of *interview* is to some extent opaque and the same holds for *curiosity*.

Katamba and Stonham refer to Greenberg (1954), who invokes the notions of obligatoriness and productivity to distinguish between inflection and derivation. Greenberg (1954) argued that inflection occurs when syntax imposes obligatory choices from a menu of the affixes, as can be seen with the demonstrative in English, according to Katamba and Stonham. He suggested that the inflectional category of number in the demonstrative must always have the same number category as the noun it modifies, as can be seen in (11).

11.	(a)	D _{sing} N _{sing}	D _{plur} N _{plur}	
		this book	these books	
		that book	those books	
	(b)	D _{plur} N _{sing}	D _{sing} N _{plur}	
		*these book	*this books	
		*those book	*that books	

Plag (1998: 44) contends that the property of an affix to be used to coin new complex words is referred to as the **productivity** of that affix. Plag suggests that not all affixes possess this property to the same degree; some affixes do not possess it at all, such as the nominal *-th* as in *length*. Productivity (or generality) distinguishes inflection from derivation, but, the suffixation of the English adverb-forming *-ly* suffix, as in quickly, from adjectives to form adverbs create a problem for generality, according to Katamba and Stonham.

Katamba and Stonham (2006: 223) contend that inflectional morphology deals with whatever information about word-structure is relevant to syntax. They further state that inflectional properties of words are assigned by syntax and depend on how a word interacts with other words in a phrase, clause or sentence. Katamba and Stonham cite Anderson (1988a: 167),

who identified four kinds of morphological properties or categories that characterise inflection:

- (i) Configurational properties
- (ii) Agreement properties
- (iii) Inherent properties
- (iv) Phrasal properties

Katamba and Stonham refer to Anderson (1990), who maintains that the diminutives and augmentatives are marked by affixes that are at the heart of the inflectional system, in many African languages. They mention that it is unclear as to whether the diminutive and the augmentative prefixes are inflectional or derivational, as there are languages where the same affix may have both inflectional and derivational use, as is illustrated in (12).

12.	<u>(Unmarked) class</u>	<u>Diminutive</u>	<u>Augmentative</u>
	(a) Sg mu-kazi (class 1)	ka-kazi (class 12)	gu-kazi (class 20)
	‘woman’	‘little woman’	‘enormous woman’
	(b) Sg ka-solya (class 12)	ka-my (class 12)	ka-sera (class 12)
	‘roof’	‘hare’	‘porridge’

The notion of relevance plays a crucial part in inflection, hence, Katamba and Stonham (2006) cite Bybee (1985: 13), who defines relevance by stating that if two semantic elements are highly relevant to each other, they are likely to be expressed lexically or by morphological inflection. But if they are not highly relevant to each other, syntactic expression is more probable. The examples in (13) illustrate this notion.

13. (a) **Lexical causatives**
- drop ‘cause to fall’
- kill ‘cause to die’
- (b) **Morphological causatives**
- widen ‘make wide’
- shorten ‘cause to become short’

- (c) **Syntactic causatives**
 make someone happy
 cause to riot

Katamba and Stonham are in consonant with Bybee's suggestion that grammatical function-changing rules determine derivational expression. They argue that passivation is regarded as derivational process by Bantuists on the ground that it brings about a drastic change in the syntactic properties of the verb, as is illustrated in (14).

14.	(a)	<u>Active</u>		(b)	<u>Passive</u>	
		Subj.	Verb	Object	Subj.	Verb
		Petero	a-liyoza	engoye.	Engoye	zi-liyoz-ebwa.
		Peter	he fut-wash	clothes	clothes	they fut-wash-passive
		'Peter	will wash	the clothes'	'The clothes	will be washed'

They suggest that the prototypical inflectional morphemes (e.g., verbal affixes in English) are very strongly syntactically determined while prototypical derivational morphemes (e.g., **-er** as in worker) are very weakly syntactically determined. They argue that in between there is a continuum of syntactic determination. Katamba and Stonham (2006) distinguish three kinds of morphological properties of verbs or categories that characterise inflection; inherent, agreement and configurational properties of verbs. The common inherent verbal properties are; tense, aspect, mood and conjugation classes. These categories add further specification to predication i.e. to the event, state, process or action indicated by the verb, according to Katamba and Stonham. They specify these verbal inflectional categories in the following manner:

First, **tense** specifies the time of the predication in relation to some particular moment, according to Katamba and Stonham. They distinguish three tenses, as is illustrated in (15).

15.	<u>Past</u>	<u>Present</u>	<u>Future</u>
	(Before now)	(Now)	(After now)
	ni-li-leta	ni-na-leta	ni-ta-leta
	I-past-bring	I-pres-bring	I-fut-bring
	'I brought'	'I bring'	'I shall bring'

Second, **aspect** indicates whether an event, state, process or action that is denoted by a verb is completed or in progress, and it overlaps the inflection / derivation dichotomy, according to Katamba and Stonham. The examples in (16) illustrate this notion.

16. (a) **Simple past tense**
 Il chanta.
 ‘He sang.’
- (b) **Imperfective / progressive aspect**
 Il chantait quand Yvonne arriva.
 ‘He was singing when Yvonne arrived.’
- (c) **Perfective aspect (completed action)**
 Il avait chanté quand Yvonne arriva.
 ‘He had sung when Yvonne arrived.’

Third, **mood** describes an event in terms of whether it is necessary, possible, permissible and desirable, according to Katamba and Stonham. The examples in (17) illustrate this notion.

17. (a) You must go. (Necessity)
 (b) You can go. (Possibility)
 (c) You may go. (Permission)
 (d) You ought to go. (Desirability)

Katamba and Stonham point out that in Greenlandic, inflection is used to mark mood, hence, inflectional affixes include a potential mood which indicates that something is possible, an epistemic mood which shows the extent of the speaker’s certainty, an evidential mood which is used in hearsay reports where the speaker cannot personally vouch for the truthfulness of a statement and a debitive mood which is used to express physical or moral obligation. Katamba and Stonham cite Fortescue’s (1984) examples in (18).

18. (a) **Potential mood**
 timmi-sinnaa-vuq
 fly can 3PS_I
 ‘It can fly’

(b) **Epistemic mood**

Nuum-mi api-nnguatsiar-puq
 Nuuk-locative snow presumably 3PS_I
 ‘It’s presumably snowing in Nuuk’

Nilli-runar-puq
 Be-cold undoubtedly 3PS_I
 ‘it (the water) is undoubtedly cold’ (e.g., from looking at it)

(c) **Evidential mood**

nalunaaquta pingasut tuqu-sima-vuq.
 clock three die apparently 3PS_I
 ‘He died at three o’clock’

(d) **Debitive mood**

imir-niru-saiaqar-putit
 drink more must 2PS_I
 ‘You must drink more’

Katamba and Stonham state that in many languages verbs belong to a number of distinct morphological classes called conjugations. They specify that the inflectional affixes that a verb can take depends on the conjugation that it belongs to. The examples in (19) illustrate this notion.

19. <u>Conjugation:</u>	<u>1st</u>	<u>2nd</u>	<u>3rd</u>	<u>4th</u>
Infinitive	-are	-ere	-ere	-ire
2SG Present	-as	-es	-is	-is
1SG Future	-bo	-bo	-am	-am
1SG Past	-avi	-i	-i	-vi

In many languages the verb has agreement markers which are determined by the characteristics of some other word in the same construction. According to Katamba and

Stonham such markers may indicate properties such as person, gender and number. This can be illustrated in the examples in (20).

20.	<u>Class a</u>	
	Omushomesa aza.	‘The teacher is coming’
	Abashomesa baza.	‘The teachers are coming’
	<u>Class b</u>	
	Ekicuncu kiza.	‘The lion is coming’
	Ebicuncu biza.	‘The lions are coming’
	<u>Class c</u>	
	Embuzi eza.	‘The goat is coming’
	Embuzi ziza	‘The goats are coming’

Katamba and Stonham (2006: 250) regard number and gender as the two commonest inherent categories of nouns. Number is used in the analysis of word-classes so as to distinguish whether they are singular or plural. Katamba and Stonham suggest that number is not universally an obligatory inflectional category, but however, noun classification is found in numerous sub-Saharan African languages, where the noun classes are marked using the prefixes, as is shown in (21).

21.	<u>Singular</u>	<u>Plural</u>
	(a) m- (class 1)	wa- (class 2)
	(b) m- (class 3)	mi- (class 4)
	(c) ki- (class 7)	vi- (class 8)
	(d) N- (class 9)	N- (class 10)

They suggest that within a noun phrase, agreement rules copy an inherent feature of the noun (e.g., gender and/or number) on to other words such as articles, numerals and adjectives in construction with it. Thus, agreement can be shown in the following Swahili examples in (22).

22.	(a)	m-t-oto	-toto m-moja m-dogo
		‘child’ class 1, sg)	one small child’
		wa-totto wa-toto	a-tatu wa-dogo
		‘children’ (class 2, pl.)	‘three small children’
	(b)	ki-tabu	ki-tabu ki-moja ki-dogo
		‘book’ (class 7, sg)	‘one small book’
		vi-tabu	vi-tabu vi-tatu vi-kubwa
		‘books’ (class 8, pl)	‘three big books’

Katamba and Stonham conclude by exploring the property of case in their consideration of the larger syntactic configurations. They specify that case is used in at least two different senses in literature:

- (i) Grammatical case, where case is used to mark the function of a noun or noun phrase for example, as subject or object, depending on its position in relation to the verb in the sentence, as in (23) below.

23.	(a)	Agricol-a _(nom.)	puell-am _(accus.)	videt
		subject	object	
		Farmer	girl	sees
		‘The farmer sees the girl.’		
	(b)	Agricol-a _(nom.)	videt	puell-am _(accus.)
		subject		object
		Farmer	sees	girl
		‘The farmer sees the girl.’		

They explain that in Latin the nominative case marks the subject, while the accusative case marks the object.

- (ii) Oblique case, marks the semantic function of a noun, and as such marks location or direction. Katamba and Stonham mention that a common oblique case is the instrumental which marks a noun phrase denoting some entity which is used to perform the action indicated by the verb, as is illustrated in (24).

24. (a) He chopped the tree down with an axe.
 (b) John fought the tiger with bare hands.

2.3 THE DESCRIPTIVE NATURE OF DEVERBAL NOMINALS

The purpose of this section is to outline the descriptive nature of deverbative nouns in African languages. Most African languages have a special way of deriving nouns from other word categories. Du Plessis (1997: 21) points out that nouns may be recognized morphologically, and that all nouns in African languages are specified for a certain noun class which are recognized through prefixes. Du Plessis asserts that the changing of a verb into a noun occurs by means of the rules of lexical derivation, as can be illustrated in (1) below for Xhosa:

- | | | | | |
|----|-----|----------------|---|----------------------|
| 1. | (a) | sebenza (work) | > | umsebenzi (worker) |
| | (b) | gula (sick) | > | umguli (sick person) |
| | (c) | baleka (run) | > | imbaleki (runner) |

Burton and Kirk (1976: 158) cite Bennet (1970) who defined a noun class as a set of nouns which share a concordance pattern of adjective, pronoun, and verb prefixes. Burton and Kirk further specify that the rules governing these prefixes are called concordance rules. This is regarded by Herbert (1985: 176) as an extensive system of agreement exhibited by Bantu languages, whereby all subordinated words agree with the gender of the noun to which they are subordinated.

The organization of this section is as follows: sub-section 2.3.1 will give a description of the nominal deriving mechanisms of the Zulu nouns followed by the derivation of nouns from other nouns, the derivation of deverbal nominals, and the derivation of nouns from other word categories. In sub-section 2.3.2, the morphology of Siswati deverbal nominals will be given, followed by the derivation of Venda deverbal nominals, in sub-section 2.3.3. In sub-section 2.3.4, the morphology of Setswana deverbal nominals will be provided, followed by sub-section 2.3.5, where the deverbal nominals of Sotho will be given, followed by the deverbal nominals of Tsonga in sub-section 2.3.6. In section 2.4, the focus will be on noun classification, and in section 2.5 Bantu noun morphology will be investigated followed by the concluding remarks in section 2.6.

2.3.1 The derivation of nouns in Zulu

Poulos and Msimang (1998: 79) specify that the noun in Zulu consists of two main parts, a noun prefix and a noun stem, and that every noun belongs to a noun class by virtue of the form of its prefix. The derivation of these nouns occurs in various ways. The following subsections will illustrate the manner in which these derivations manifest in Zulu linguistics. Poulos and Msimang suggest that nouns in Zulu may be derived within classes, as is the case with class 7 nouns derived from other classes in order to denote a certain language or culture or behavior patterns characterizing a certain group of individuals, as is illustrated in (2) below:

2. (a) umfazi (1) (woman) > isifazane (women folk/ behavior)
- (b) umlungu (1)(white person) > isilungu (White way of doing things)
- (c) isoka (5)(bachelor) > isisoka (behavior typical of a ladies man)

The derivation of class 7 nouns from other nouns may indicate plantation, and class 5 and 9 nouns derived from class 3 nouns may refer to fruit/seed, respectively, according to Poulos and Msimang. The examples in (3) and (4) indicate this aspect.

3. (a) ubhanana (1a) (banana) > isibhanana (plantation of bananas)
- (b) ugwayi (1a) (tobacco) > isigwayi (field of tobacco)
- (c) ubhatata (1a)(sweet potato > isibhatata (field of sweet potatoes)
4. (a) igilebhisi (5) (grape) > umgilebhisi (grape tree/vineyard)
- (b) ikhiwane (5) (fig) > umkhiwane (fig tree)
- (c) indoni (9) (fruit of umdoni) > umdoni (The Cordate water myrtle)

Some derived nouns may denote quality or nature of the object from which the noun is derived from, and some of these nouns may acquire effective significance depending on the context in which they are used, according to Poulos and Msimang. This is pertinent in nouns derived from class 14 abstract nouns, as can be illustrated in (5).

5. (a) ubuthakathi (witchcraft) > umthakathi (wizard)
- (b) ubuntu (humaneness) > umuntu (person)
- (c) ubufazi (woman nature) > umfazi (woman)

- Nouns derived from other word categories

Poulos and Msimang outline that the derivation of nouns may occur from primitive stems, which cannot be reduced into a simpler form, in some cases. The few examples in (6) illustrate such stems below:

6. (a) -ntu in umntu (person)
 (b) -thi in umuthi (tree)
 (c) -zi in umuzi (village)
 (d) -limi in ulimi (tongue)
 (e) -suku in ubusuku (night)

The most commonly derived noun stems are those that have been derived from verb roots, according to Poulos and Msimang. These forms are dealt with in the subsequent subsections.

- Nouns derived from verbal forms – deverbatives

Poulos and Msimang (1998: 81) maintain that Zulu nouns are derived by adding a noun prefix to the verb root, and adding some or other suffix to the root so as to change it into a stem. This can be illustrated in (7) below:

7. (a) umthwalo (3) a load < -thwal- carry (a load)
 (b) impendulo (9) answer, reply < -phendul- answer
 (c) impilo (9) life < -phil- live

Poulos and Msimang outline the difference in the derivation of personal deverbatives from non-personal deverbatives. Personal deverbatives are depicted by the occurrence of the prefixes of classes which include personal nouns and the suffix *-i*. The non-personal deverbative also have prefixes of classes which include impersonal nouns and the suffix *-o*. These deverbatives may indicate instrument, process or state implied by the meaning of original root, according to Poulos and Msimang. The examples in (8) and (9) illustrate these deverbatives.

8. **Personal deverbatives**

- (a) -fund- learn (verb root) > umfundi (1) student
 (b) -theng- buy (verb root) > umthengi (1) customer
 (c) -hamb- go, walk (verb root) > umhambi (1) traveller

9. **Non-personal deverbatives**

- (a) -baz- chop (verb root) > imbazo (9) axe
 (b) -lil- cry (verb root) > isililo (7) crying

Poulos and Msimang mention that the non-productive deverbatives may have few instances of the suffixes **-a**, **-e**, and **-u**, as is illustrated in (10).

10. (a) ithemba (5) hope, trust < -themb- to hope / trust
 (b) isifebe (7) prostitute < -feb- indulge in prostitution
 (c) ingungu (9) drum < -ngung- enclose / surround

Personal nouns can be formed by suffixing the following formatives onto the verb root: **-ose-**; **-ane-**; **-angane-**; **-ase-**, according to Poulos and Msimang. These suffixes add intensity to the action denoted by the verb, as is shown in (11).

11. (a) -zam- try > umzamose the one who is always crying
 (b) -hamb- go, travel > uhambangane always on the move
 (c) -zul- wander > uzulase constant wanderer

The passive extended verb roots can take on the suffix **-a** to form deverbatives, as is illustrated in (12) below:

12. (a) -thandw- be loved (passive root) > isithandwa (1) a beloved one
 (b) -dalw- be created (passive root) > isidalwa (7) creature

- | | | | | | | |
|----|-----|------------|-----------------|---|-----------|----------------|
| 1. | (a) | intsambama | afternoon | < | -tsambam- | turn afternoon |
| | (b) | lincusa | messenger | < | -ncus- | send a message |
| | (c) | luhlanya | lunatic | < | -hlany- | be mad |
| 2. | (a) | sitfunywa | messenger | < | -tfunyw- | be sent |
| | (b) | siboshwa | prisoner | < | -boshw- | be bound |
| | (c) | sitfunjwa | prisoner of war | < | -tfunjw- | be raided |

Personal deverbatives are characterized by the ending *-i*, which refers to the person carrying out the action of the verb, according to Ziervogel and Mabuza. The impersonal nouns, on the other hand, are characterized by the ending *-o*, which also has reference to the action verb or the manner in which it is performed or an object derived from the action. This can be shown in the examples in (3) and (4) respectively.

3. **Personal deverbatives**

- | | | | | | |
|-----|------------|----------|---|-----------|------------------|
| (a) | umtsakatsi | sorcerer | < | -tsakats- | practise sorcery |
| (b) | soni | sinner | < | -on- | sin |
| (c) | intfombi | girl | < | -tfomb- | reach puberty |

4. **Impersonal nouns**

- | | | | | | |
|----|-----------|------|---|----------|-------|
| a. | umtfwalo | load | < | -tfwal- | carry |
| b. | libito | name | < | -bit- | call |
| c. | inkhulumo | talk | < | -khulum- | talk |

2.3.3 The derivation of Venda deverbal nominals

Poulos (1990: 67) states that nouns in Venda are classified in terms of a class system, each noun belonging to a particular class. The derivation of nouns occurs in a specific way. These nouns may be derived from primitive stems, as is the case with Zulu nouns. The main focus here is on the derivation of these nouns from verb roots.

- Nouns derived from verbal forms – deverbatives

Poulos (1990: 68) specifies that the nouns that are derived from the verb are formed by adding the prefix and the suffix to the verb root. This may be illustrated in (1) below:

- | | | | | | | |
|----|-----|----------------|-------------------|---|----------|------|
| 1. | (a) | mushumi (1) | a worker | < | -shum- | work |
| | (b) | dzhavhelo (5) | a place of refuge | < | -shavel- | flee |
| | (c) | vhutshilo (14) | life | < | -tshil- | live |

Poulos makes a distinction between personal and impersonal deverbatives, and describes personal deverbatives as being characterized by the occurrence of one or other prefixes of classes which include personal nouns, as well as the suffix which is typically **-i**. The impersonal nouns, on the other hand, are characterized by the addition of prefixes of classes which include impersonal nouns, as well as by suffixing **-o**. These may be illustrated in (2) and (3), respectively.

2. Personal deverbatives

- | | | | | | |
|-----|--------|-----------------------|---|---------------|--|
| (a) | -funz- | instruct (verb root) | > | mufunzi (1) | missionary |
| (b) | -l- | eat (verb root) | > | muli (1) | eater |
| (c) | -luv- | do homage (verb root) | > | tshiluvhi (7) | one who pays
homage to his
chief |

3. Non-personal deverbatives

- | | | | | | |
|-----|----------|------------------|---|----------------|-----------|
| (a) | -vhad- | chop (verb root) | > | mbado (9) | axe |
| (b) | --tshil- | live (verb root) | > | vhutshilo (14) | life |
| (c) | -divh- | know (verb root) | > | ndivho (9) | knowledge |

There are exceptional cases whereby the non-personal deverbatives end with the suffix **-i**, and there are those deverbatives which are formed from the passive extended verb roots (henceforth, passive verb) take on the suffix **-a**, according to Poulos. This may be illustrated in (4) and (5), respectively.

4. (a) -vhon- see (verb root) > tshivhoni (7) mirror
 (b) -kokovh- crawl (verb root) > tshikokovhi (7) reptile
5. (a) -funw- be loved (passive evr) > mufunwa (1) a beloved one
 (b) -runw- be sent (passive evr) > murunwa (1) messenger
 (c) -vhumbw- be created (passive evr) > tshivhumbwa (7) creature

Poulos mentions nouns that are derived from verb roots which may take the suffix *-e*, as is illustrated in (6) below:

6. (a) -lil- cry (verb root) > malile (1a) a cry baby
 (b) -tshimbil- walk, travel (verb root) > kutshimbilele (20) way of walking
 (c) -beb- bear, carry my child on back (verb root) > tshibebe (7) go in single file, pressed tightly together

2.3.4 The morphology of Setswana deverbal nominals

Krüger (2006: 113) is of the view that the linear syntagmatic level deverbatives include the following types of morphemes arranged in the given order:

- (a) Noun class prefix
 (b) Verbal root
 (c) Deverbative suffix

Krüger regards noun classes as being central in determining the semantic value of deverbatives. He also places deverbative endings as being crucial in distinguishing the interpretation of deverbal nouns, as is illustrated in subsequent sub-sections.

- Deverbatives in the noun classes 1 (mo) and 2 (ba)

Krüger declares that deverbatives in these classes denote humans as ordinary performers of the process without any additional semantic properties, as is illustrated in (1) – (3).

1. With suffix **-i**

- | | | | | | |
|-----|---------|----------------|---|--------|-----------------|
| (a) | go-dira | to do, to work | > | modiri | worker, servant |
| (b) | go-busa | to govern | > | mmusi | governor |
| (c) | go-bega | to report | > | mmegi | reporter |

Krüger specifies that if the infinitive occurs in the passive form the basic ending is retained, and there are also few active infinitives where the ending is retained, as is shown in (2) and 3, respectively.

2. With suffix **-a**

- | | | | | | |
|-----|-------------|----------------|---|------------|-----------|
| (a) | go-golegwa | to be captured | > | mogolegwa | a capture |
| (b) | go-lalediwa | to be invited | > | molalediwa | a guest |
| (c) | go-lekana | to be alike | > | molekana | a friend |

3. With verbal prefixes

- | | | | | | |
|-----|-------------|--------------------|---|-----------|-----------------|
| (a) | go-ithuta | to learn, to study | > | moithuti | a scholar |
| (b) | go-re-swela | to die for us | > | moreswedi | a redeemer |
| (c) | go-nthata | to like me | > | monthati | one who like me |

- Classes 3 (mo-) and 4 (me-)

Krüger suggests that deverbatives in these classes indicate the manner or method according to which the action is executed or the result or consequence of the action, as shown in (4), whereas a small number of deverbatives assume the suffix **-a**, as can be illustrated in (5).

4. With suffix **-o**

- | | | | | | |
|-----|-----------|------------------|---|----------|--------------------|
| (a) | go-epa | to dig | > | moepo | mine |
| (b) | go-bina | to dance | > | mmino | manner of dancing |
| (c) | go-leboga | to thank someone | > | molebogo | manner of thanking |

5. With suffix **-a**

- | | | | | | |
|-----|-----------|-------------------|---|----------|-----------------------------------|
| (a) | go-bopa | to mould, to form | > | mmopa | clay for pottery |
| (b) | go-laetsa | to send a message | > | molaetsa | message |
| (c) | go-laetsa | to invite | > | molaetsa | work part, invited
to give aid |

- Classes 5 (le-) and 6 (ma-)

These deverbatives denote customs , characteristics and tendencies that are intensely experienced by the individual and humans with peculiar and sometimes derogatory characteristics, according to Krüger, as is indicated in (6). In these classes deverbatives with the suffix **-i** denote grammatical terminologies, as is illustrated in (7) below:

6. With suffix **-o**

- | | | | | | |
|-----|-----------|------------|---|----------|-----------|
| (a) | go-tloa | to hate | > | letloo | hatred |
| (b) | go-nyala | to marry | > | lenyalo | a wedding |
| (c) | go-nyatsa | to despice | > | lenyatso | contempt |

7. With suffix **-i**

- | | | | | | |
|-----|------------|----------------|---|-----------|----------------|
| (a) | go-dira | to do, to work | > | lediri | verb |
| (b) | go-thusa | to help | > | lethusi | auxiliary verb |
| (c) | go-kopanya | to unite | > | lekopanyi | conjunction |

There are those deverbatives which denote persons that occupy some social status, most in the derogatory sence, according to Krüger, as can be shown in (8) below:

8. With suffix **-a**

- | | | | | | |
|-----|----------|----------------------------|---|---------|------------|
| (a) | go-fetwa | to be surpassed/ overtaken | > | lefetwa | a spinster |
| (b) | go-goat | to shout, to cry | > | legoa | a loud cry |
| (c) | go-tagwa | to get drunk | > | letagwa | a drunkard |

- Classes 7 (se-) and 8 (di-)

Krüger (2006: 117) regards deverbatives with the suffix **-i** as denoting persons who conduct the process in an expert or special manner or who have special functions. Consider the examples in (9) below:

9. With suffix **-i**
- | | | | | | |
|-----|-----------|----------|---|----------|-------------------|
| (a) | go-kwala | to write | > | sekwadi | profound writer |
| (b) | go-aga | to build | > | seagi | expert builder |
| (c) | go-tshela | to live | > | setshedi | a living creature |

Krüger stipulates that there are a number of deverbatives derived from the active form in which the suffix **-a** is retained, and some of these deverbatives denote persons with special qualities while others denote special objects, as can be illustrated in (10). The deverbatives with the suffix **-o**, on the other hand, comprise mostly special instruments, products and human activities, according to Krüger, as is indicated in (11) below:

10. With suffix **-a**
- | | | | | | |
|-----|------------|--------------------|---|-----------|------------|
| (a) | go-tsenwa | to get into | > | setsenwa | a lunatic |
| (b) | go-atlhama | to open ones mouth | > | seatlhama | an idiot |
| (c) | go-gwapa | to become dry | > | segwapa | dried meat |

11. With suffix **-o**
- | | | | | | |
|-----|------------|------------|---|-----------|-------------|
| (a) | go-besa | to roast | > | sebeso | a fireplace |
| (b) | go-bolaya | to kill | > | sebolao | weapon |
| (c) | go-lekanya | to compare | > | selekanyo | measure |

- Classes 9 (N-) and 10 (di(N)-)

Some deverbative in these classes denote persons and objects while others denote grammatical terms, according to Krüger, as is illustrated in (12) and (13) respectively. Krüger specifies that deverbatives with the suffix **-o** denote abstraction and result of the act specified by the verb, as is illustrated in (14) below:

12. With suffix **-i**
- | | | | | | |
|-----|-----------|------------|---|--------|------------------------|
| (a) | go-bega | to report | > | pegi | correspondent, message |
| (b) | go-dirisa | to use | > | tirisi | causative suffix |
| (c) | go-dirwa | to be done | > | tirwa* | passive suffix |

13. With suffix **-a**
- | | | | | | |
|-----|---------|----------------------|---|----------------|--------------|
| (a) | go-ripa | to cut | > | thipa | knife |
| (b) | go-supa | to show, to indicate | > | tshupa | index finger |
| (c) | go-fofa | to fly | > | phofa (lefoka) | feather |

14. With suffix **-o**
- | | | | | | |
|-----|-------------|------------|---|----------|--------------------|
| (a) | go-tlhalosa | to explain | > | tlhaloso | explanation |
| (b) | go-bitsa | to call | > | pitso | meeting, gathering |
| (c) | go-itse | to know | > | kitso | knowledge |

- Class 11 (lo-) and plural 10 (di(N)-)

Krüger points out that there are very few deverbatives in Setswana in this class and it is difficult to determine the semantic content of these deverbatives, as is illustrated in (15).

15. With suffix **-o**
- | | | | | | |
|-----|----------|----------------|---|---------|-------------------|
| (a) | go-feela | to sweep | > | lofeelo | a big broom |
| (b) | go-huma | to become rich | > | lohumo | wealth |
| (c) | go-swa | to die | > | loso | death (of humans) |

- Class 14 (bo-) and plural class 6 (ma-)

Krüger states that the semantic value of class 14 (bo-) indicates abstractness of the process, as is shown with both the suffix **-i** and the suffix **-a** in (16) and (17) respectively, whereas the status of the performer or the place where the procession / action takes place, is illustrated in (18) below:

16. With suffix **-i**
- | | | | | | |
|-----|------------|--------------------------|---|-----------|------------------|
| (a) | go-aba | to divide, to distribute | > | boabi | act of dividing |
| (b) | go-atlhola | to judge | > | boatlhodi | judge profession |
| (c) | go-kwala | to write | > | bokwadi | authorship |

17. With suffix **-o**
- | | | | | | |
|-----|------------|------------|---|-----------|------------|
| (a) | go-ipolela | to confess | > | boipolelo | confession |
|-----|------------|------------|---|-----------|------------|

- (b) go-ingotla to humble oneself > boingotlo humility
 (c) go-khutla to cease, to end > bokhutlo the end

18. With suffix **-a**

- (a) go-rena to rule, to govern > borena domination, rule
 (b) go-ripa to cut in two > boripa brevity
 (c) go-ima to expect a child > boima heaviness, weight

2.3.5 The deverbal nominals of Northern Sotho

Poulos and Louwrens (1994: 49) specify that all nouns in Northern Sotho consists of two main parts, a noun prefix and a noun stem. They maintain that nouns are derived from verb roots, by adding a noun prefix to the root of the verb, and a suffix is added to the root of the verb changing it to a stem. This can be illustrated in (1) in the derivation of the noun **moruti** (missionary) which is derived from the verb root **-rut-** (teach, instruct). The prefix **mo-** and the suffix **-i** have been added to the verb root **-rut-**, thereby, deriving the noun **moruti**. The following examples in (1) demonstrate the derivation of deverbatives from different verb roots.

- Nouns derived from verbal forms

1. (a) mosomi (1) a worker < -som- work
 (b) morwalo (3) a load < -rwal- carry (a load)
 (c) lerato (5) love < -rat- love
 (d) seeta (7) a boot, shoe < --et- travel
 (e) phetolo (9) an answer, reply < -fetol- answer
 (f) bophelo (14) life < -phel- live

Poulos and Louwrens distinguish between personal and impersonal deverbatives, and describe personal deverbatives as being characterized by the occurrence of one or other prefixes of classes which include personal nouns, as well as the suffix which may be either **-i** or **-a**. The impersonal nouns, on the other hand, are characterized by the addition of prefixes of classes which include impersonal nouns, as well as by suffixing **-o**, **-i** or **-a**. These deverbatives are illustrated in (2) and (3), respectively.

2. Personal deverbatives

- (a) -som- work (verb root) > mosomi (1) worker
 (b) -ngwal- write (verb root) > mongwadi (1) writer
 (c) -rat- love (verb root) > moratiwa (1) beloved

3. Non-personal deverbatives

- (a) -thab- be happy (verb root) > lethabo (5) joy
 (b) -dir- do (verb root) > lediri (5) a verb
 (c) -gwap- dry up (verb root) > mogwapa (3) dried meat

Sometimes the suffix **-a** is found in deverbatives which are formed from passive extended verb root, and at times the suffix **-a** occurs in deverbatives which are in the active form, according to Poulos and Louwrens, as is illustrated in (4) and (5) respectively.

4. (a) -ratw- be loved (passive evr) > moratiwa (1) beloved one
 (b) --rongw- be sent (passive evr) > morongwa (1) messenger
 (c) -golegw- be imprisoned (passive evr) > mogolegwa (7) prisoner
5. (a) -fseg- be afraid (verb root) > lefsega (5) a coward
 (b) -tlael- become confused (verb root) > setlaela (7) fool
 (c) -lat- follow > molata (1) follower, subject

2.3.6 The deverbal nominals of Tsonga

Baumbach (1987: 142) suggests that noun stems may be derived from the stems of other parts of speech by means of a prefix, or of a suffix or by means of a prefix and suffix together.

- Derivation with class prefixes and suffixes

Baumbach (1987: 145) is of the view that when the suffix **-i** is used in conjunction with prefixes **mu-** (cl. 1) and **xi-**, it indicates the doer / performer of the action indicated by the verb, as can be illustrated in (1) below:

1. (a) muvatli 1 / 2 carpenter < -vatla do carpentry work
- (b) xikokovi 7 / 8 reptile < -kokova crawl on the belly
- (c) mutsari 1 / 2 writer < - tsala write
- (d) vutivi 14 knowledge < -tiva know

The suffix **-o** together with different clas prefixes indicates the following, according to Baumbach:

(i) the instrument with which an action is performed, , as can be shown in (2).

2. (a) xikhaviso 7 / 8 ornament < -khavisa adorn, decorate
- (b) xiphaho 7 / 8 scoop < -phaha scoop out
- (c) ntlhavo 9 / 10 awl, gimlet < -tlhava pierce

(ii) the (finished) result of action

3. (a) byako 14 dwelling < -aka build
- (b) xikhongelo 7 / 8 prayer < -khongela pray
- (c) xitiviso 7 / 8 announcement < -tivisa announce, inform

(iii) the place where the action performed when affixed to a verb stem with **-el-** in the last syllable.

4. (a) xirilelo 7 / 8 place of sorrow < rila cry
- (b) dyelo 5 / 6 pasture < dya eat
- (c) xidzahelo 7 / 8 snuffbox < dzaha smoke

Baumbach suggests that the suffix **-w** derived from the passive suffix **-iw** indicates that the completed result of the action indicated by the verb or the patient which undergoes the action, as is illustrated in (5).

5. (a) matsalwa 6 literature < -tsala write
- (b) murhumiwa 1 / 2 messenger < -rhuma send
- (c) murhandziwa 1 / 2 loved one < -rhandza love

- (b) kihaato kingi kiega 'another good broom'
 (c) kihaato giakwa kiega 'my good broom'

Class 11

- (d) ruhiu ruega 'a good sword'
 (e) ruhiu rungi ruega 'another good sword'
 (f) ruhiu ruakwa ruega 'my good sword'

Burton and Kirk point out that the syntactic function of Bantu noun class is clear, but, less obvious is the semantic status of noun classes. They cite Hoffman (1963: 159) who asserts that the noun classes are only morphological categories and void of any meaning whatsoever. Burton and Kirk hold a different view to Hoffman, and they undertook a psycholinguistic experiment to demonstrate that the syntactic category has meaning; the semantic status of the category could be determined by the observed patterns of distribution of words across syntactic categories.

Burton and Kirk (1976: 159) indicate that Leakey has produced the most complete description of meanings of Bantu noun class system, as is illustrated in (2).

2. Class 1: primarily human
 Class 3: most large trees and plants
 Class 9: most living things not included in 3
 Class 7: primarily inanimate objects
 Class 5: objects or beings with supernatural significance
 Class 11: the concept of undulation is a feature of this class
 Class 13: diminutiveness

Burton and Kirk allude to Hale's (1973) parallel analysis where he discusses the possibility for evaluative rank ordering of syntactic categories along a semantic dimension. He ranked Navaho in three classes (reference to people, animate and inanimate) and that rank ordering is necessary to an understanding of subject-object inversion, a purely syntactic phenomenon.

Burton and Kirk undertook a psycholinguistic triads experiment to show that the noun class categories do have a semantic significance, and the responses to the test were analyzed using

Table 1. Three paradigms containing minimal contrast on noun classParadigm 1 Large Insects vs Small Insects

	class 11	class 9
Large Insect	ruruto preying mantis	ndahi grasshopper
Small Insect	ruagi mosquito	ngi housefly

Paradigm 2 Large Birds vs Large Insects

	class 11	class 9
Large Birds	ruigi hawk	nderi vulture
Large Insect	ruruto preying mantis	ndahi grasshopper

Paradigm 3 Large Birds vs Small Insects

	class 11	class 9
Large Birds	ruigi hawk	nderi vulture
Small Insect	ruagi mosquito	ngi housefly

Burton and Kirk conclude that the results of their psycholinguistic triads experiment indicate that the triads data is consistent with the hypothesis that noun class has an effect on triads choices, but that the effect of noun class is subsidiary to the effects of distinctions of size and

phlogeny. They further state that the noun class is treated as a tertiary feature by the Kikuyu respondents when doing semantic classification.

2.4.2 The semantics of noun classes in Proto-Bantu

In this sub-section, the main focus is on the question of the configuration of the noun classes for associating each noun class prefix with a characteristic semantic meaning. Denny and Creider (1986: 217) acknowledge the problem of deciding the kind of system encoded by the gender class markers which are prefixes on the noun, as is indicated by the Kikuyu **mu-ndu** 'person', **kindu** 'thing' **ha-ndu** 'place', **u-ndu** 'place'. They state that a number systems determines the prefixes and the classes in a Bantu language, and that the noun classes by themselves have no overall intrinsic semantic content.

Denny and Creider support the claim that Proto-Bantu noun prefixes realize a semantic system where each prefix is associated with a characteristic meaning, and present evidence in support of this claim. They are of the view that the bulk of noun prefixes are associated with configurational or shape meaning. This evidence is presented to demonstrate that the systems encoding meanings of this type are common among languages of the world. There are two kinds of evidence which are utilized to illustrate this notion: the direct evidence which comes from an examination of the Proto-Bantu vocabulary, and indirect evidence which consist of a discussion of noun classifier sets found in other languages, which is of secondary importance for this study.

- Direct evidence: An examination of the Proto-Bantu vocabulary

Denny and Creider (1986: 220) distinguish configuration classes according to whether solid shape (3/4, 5/6) or outline shape (9/10, 11/10) is being utilized as the basis of classification, as is shown in Figure 1.

Figure 1. Proto-Bantu noun class semantics

For count nouns:

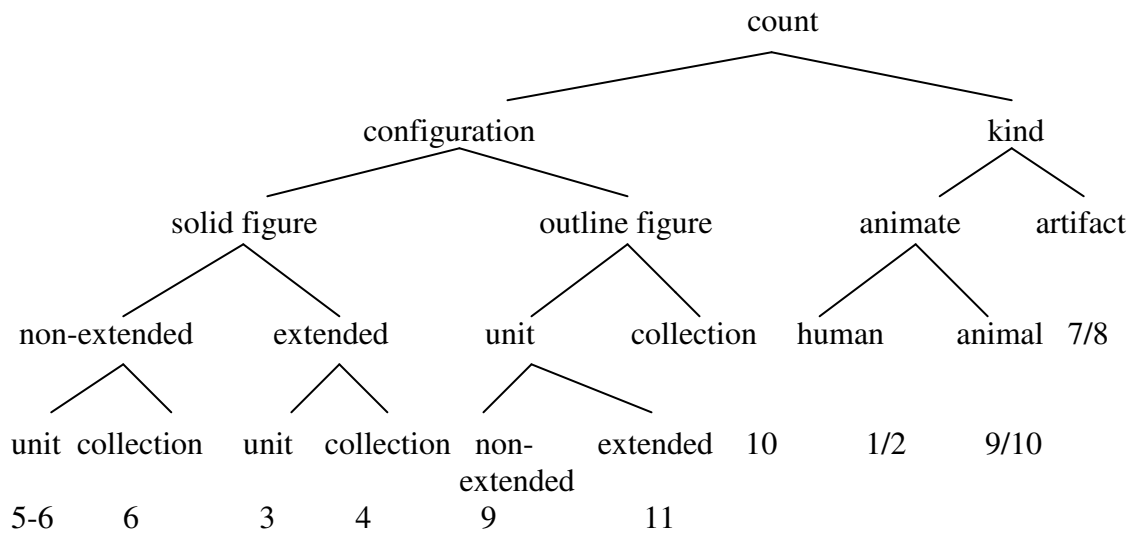

For mass nouns:

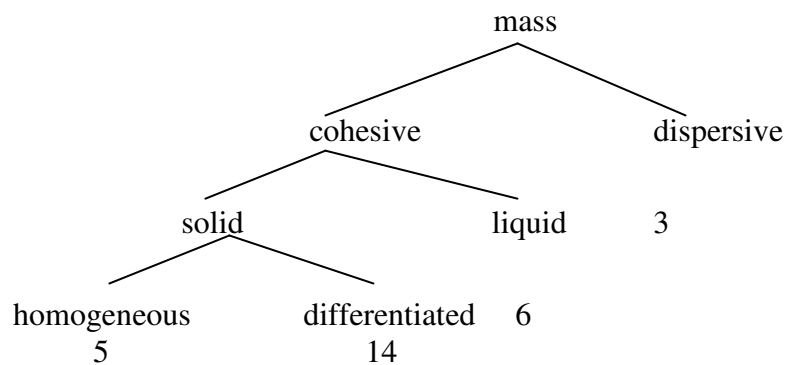

- The configurational classes

The four configurational classes 3/4, 5/6, 9/10 and 11/10 are listed in (1-4) with their semantic interpretation.

1. Class 3/4 extended (long)

concrete:

- | | | |
|-----|--------|----------------------------------|
| (a) | -bidi | body |
| (b) | -canga | sandy island (usually elongated) |
| (c) | -nue | finger |

concrete problematic

- (d) -bombó forehead (length cultural valued)
- (e) -díma (5/6) bat
- (f) -gùba (only singular) bellows

abstract:

- (g) -dimo work (cultivation)
- (h) -kíndo football
- (i) -yáka year
- (j) -yíŋci daytime (temporal extension)

2. Class 5/6 non-extended (rounded, protruded, bunched)

Concrete:

- (a) -bééde breast
- (b) -coká axe (i.e., the head)
- (c) -júba (only singular) sun

concrete problematic:

- (d) -kúpa (3/4, 7/8) bone (protrusion)
- (e) -papá (11/10) wing (protrusion)
- (f) -tú (15/6) ear (differentiate from -tú 3/4 head)

abstract:

- (g) -júì voice
- (h) -kúá inheritance
- (i) -páca twin

3. Class 9/10: non-extended, outline figure

concrete:

- (a) -bambo (7/8, 11/10) (for holding down the edge)
- (b) -já (only singular) outside
- (c) -yungú cooking pot

concrete problematic:

- | | | |
|-----|---------------------|-----------|
| (d) | -boga | vegetable |
| (e) | -da (only singular) | abdomen |
| (f) | -pígo | kidney |

abstract:

- | | | |
|-----|--------|-----------|
| (g) | -joodí | dream |
| (h) | -pépo | cold wind |

4. Class 11/10: non-extended, outline figure

concrete:

- | | | |
|-----|--------|-------------------|
| (a) | -papá | wing (protrusion) |
| (b) | -bambo | peg |
| (c) | -kígé | eyebrow |

concrete problematic:

- | | | |
|-----|-------|--------------------------|
| (d) | -cace | spark (hole in darkness) |
|-----|-------|--------------------------|

Class 9: insufficient data

- | | | |
|-----|--------|--------------|
| (e) | -dedu | beard |
| (f) | -kúnde | edible beans |

Class 10: insufficient data

- | | | |
|-----|--------|----------|
| (g) | -kuṅgu | dust |
| (h) | -kú | death |
| (i) | -pádá | baldness |

Denny and Creider (1986: 224) categorized the classes as follows: 1/2 human, 3/4 plants, 5/6 fruit, 7/8 artifacts and 9/10 animals. They also mentioned that the mass nouns constitute a semi-independent sub-system of noun classes, and that some of the morphemes from the count system overlap for the mass system.

In conclusion, Denny and Creider have shown that the noun class prefixes are associated with configurational or shape meaning in most cases, although, there are few morphemes which

seem to be problematic in terms of configuration. The indirect evidence highlighted by Denny and Creider focused on the noun classifier sets found in other languages in relation to Proto-Bantu language. This comparison of Proto-Bantu language with other Asian languages is beyond the scope of this study.

2.4.3 Maa (Maasai) Nominalization: Animacy, Agentivity and Instrument

The focus of this study examines whether there is an overlap in: (a) inherent aspect of the verb stems they occur with, (b) semantic role of the verb to which the resulting nominalization refers, (c) and animacy or humanness of the referent. Payne and Olsen (2009: 153) expatiate on the work of Kotikash (2000) by providing the Table 1 (class 1-4), which seeks to initiate a description of Maa nominalizers.

Table 1

	Singular/ number-neutral nominalizing morphology	Possible suffix sources	Plural	Nominalization examples	Verb sources
1	-ɛt (-et) Instrument. SG	?	-ɛt (-eta) Instrument. PL	-ɛn -daket mouth	da (k) eat
2	a- Patien, State	?	(PL does not occur)	-ɛn-aimin darkness	imm be lost
3	-a (+Tone?) Patient, Result	Non-perfective middle, or *EN	-iki	-ɛn -daa food -ɛn -dala game	daa eat, feed (intr)
4	a-...-a (-o) Patient, Result	Non-perfective middle, or *EN	a-...-ak (-ok)	ɔl-akesena skirt	kesen tie

Payne and Olsen (2009: 156) suggest that both a-...-ani and ɛt- nominalizers have a range of meanings, a-...-ani creates nouns referring to humans that are the doers of action, whereas, the suffix -ɛt creates nouns referring to prototypical tools such as ‘knife’ from ‘cut’. Payne and Olsen state that nominalizers have a range of meanings and as such focus their attention by establishing a hypotheses so as to investigate the overall account of their data. Their hypotheses focused on the following aspects:

Hypotheses:

1. Lexical aspect:
 - (a) Inherent lexical aspect of the verb stem does not differentiate **-et** from **a-...-ani** nominalization.
 - (b) Both **-et** and **a-...-ani** operate on Active stems, and not on Stative stems.
2. Animacy:
 - (a) **-et** creates nominalizations referring to Instrument role of a verb stem.
 - (b) **a-...-ani** creates nominalizations referring to animate referents.
3. Semantic role:
 - (a) **-et** creates nominalizations referring to the Instrument role of the verb stem.
 - (b) **a-...-ani** creates nominalizations referring to the Agent role of the verb stem.

Payne and Olsen conclude that their data suggests that there exists both an agent-instrument and an animate –inanimate contrast between the referents for these nominalizations. They further elaborate that the inherent aspect of the verb root / stem is irrelevant for distinguishing between **-et** and **a-...-ani**, but, contrary to Maa's nominalizers which show that inherent aspect is relevant to choice between Situation nominalizers like **-ata** and **-an**. They also maintain that **a-...-ani** is best considered an Animate nominalizer, motivated by semantic features inherent to the intended referent and not by a semantic relational notion. They further propose that an animacy hierarchy accounts for the use of **-et** to code literal animates which are low on the scale of animacy.

2.4.4 Moro noun class morphology

Gibbard et al (2009: 106) specify that the Moro noun class consists of eight main noun class singular / plural pairings, five unpaired classes (mass nouns, verbal nouns), and five minor categories. They maintain that the major challenge posed by noun classes in Moro concerns the status of vowel-initial noun. The main problem revolves around uncertainty as to whether an initial vowel constitutes a prefix, or whether the vowel is part of the root, and there is no noun class prefix.

They indicate that the vowel-initial nouns occur in three main class pairings and two non-paired classes, as is shown in Table (2).

Table 2

Class	Initial segment	Concord segment	Singular	Initial segment	Concord segment	Plural	Gloss	#
j / j	low V	j- s- (-k-)	ajén	higher V	j-, s-	ején	'mountain'	30
ð / j	ð-	ð	ðamala	j-/front V-	j	jamala	'camel'	13
g / n	V	g- -k-	otʃ:a	n-	n-	nətʃ:a	'milk pot'	64
g / l	V	g- -k-	evaja	l-	l-	ləvaja	'poor person'	33
j	V/s	j- -s- (-k-)	ibəg ^w ʌ	*	*	*	'fog'	11
g	V	g- -k-	evéa	*	*	*	'sand'	15

Gibbard et al suggest that the j/j class is characterized by prefixes, **a-** in the singular and **e-** in the plural, whereas the ð/j as well as the minor r/j and l/j classes, are similar to the j/j class in that the plural form has a vowel-initial prefix, as in ðrmbégwa (singular) ermbégwa (plural) 'lyre', or ðrðiə (singular) irðiə (plural) 'type of water rat'. They are of the view that if the the root is vowel-initial, the prefix is realized as [j], as in ðə^wli (singular) júlí (plural). The main problem with this class is that there is no clarity as to whether the prefix is underlyingly a vowel (/e-/) or a glide (/j-/), according to Gibbard et al.

Gibbard et al (2009: 112) state that the g/n class is characterized by one of the six vowels / a e o ʌ i u / in the initial position of the singular noun, and by a prefix /n-/ in the plural. They propose that in this class the front vowel is reduced to [ə] when it appears before [l] or a labial [b m v], as in eləŋe (singular) nələŋe (plural) 'king'. Gibbard et al argue that there is no clear evidence of a root vowel as a prefix in this class, and that the g/n class does not have a noun class prefix in the singular. They conclude that the root vowel is deleted or reduced following the plural prefix **n-** depending on the type of vowel following consonant.

The g/l class is similar to the g/l class in having a consonantal prefix in the plural and vowel initial in the singular, but , the only difference is with respect to vowel reduction and the

behaviour of the labio-velar glide [w], according to Gibbard et al. They indicate that the initial velar is deleted in Moro before all vowels except [a], as in wájá (singular) wárá (plural) ‘fly / bee’ have an initial w- noun class prefix, and that the unpaired class forms are best treated as a subset of the j / j and g / n or g / l class pairings.

In conclusion, the vowel-initial nouns have demonstrated that they can be divided into two groups, the j/j class pairing which has vowel prefixes, and the g/l and g/n classes, whose vowels are affixed to the root and may delete or reduce.

2.4.5 Noun class and gender systems in Chakali

There is a view in the literature that both these grammatical constructs, gender and noun class, are independent of one another, Brindle (2009: 84). In Chakali, there are basically four parameters in which agreement can be determined, namely, antecedent-anaphor, possessive-noun, numeral-noun and quantifier- noun. The identification of noun classes is based on non-syntagmatic evidence, by Brindle. Brindle cites Mathews (1972) who specifies that noun class is a type of inflectional class affix on nouns, where the values of number and class are set forth. In Chakali the values are exposed by suffixes, and number refers to either singular or plural and class can be regarded as phonological and/or semantic criteria encoded in the roots for the selection of the proper pair of singular and plural suffixes, according to Brindle.

The present classification of noun classes treats phonologically empty suffixes as exponents, as these noun classes are determined by a lexeme inflectional pattern, according to Brindle. Brindle specifies that most noun classes are classified under five pairs, as is illustrated in Table 3.

Table 3

	cl. 1	cl.2	cl.3	cl.4.	cl.5
SING	-V	∅	∅	-V[-LO, -H]	∅
PLUR	-sV	-sV	-V	-V	-nV

- The gender system

Brindle (2009: 88) identifies gender as a grammatical encoding of an agreement class, and it exposes how agreement manifests itself in the language. Brindle cites Corbett & Fraser (2000: 293) who are of the opinion that gender is not restricted to sex based classifications ‘male/female’ as it also encompasses semantic possibilities, such as animate, small, insect, non flesh food etc. It is on this basis that Brindle, supports the notion of treating gender as humanness. In Chakali the values for the feature gender are specified as in Table 4.

Table 4

Gender	criteria
a	residuals
b	things that are classified as human

Consider the sentences in (1) below:

1. (a) η kpaɡa bʊna-a a-naase
 1SG have goat (Ga)-PL 3PL. Ga-four
 ‘I have four goats’
- (b) η ηma ta-sa a-naase
 1SG speak language (Ga)-PL 3PL. Ga-four
 ‘I speak four languages’
- (c) η kpaɡa bi-se ba-naase
 1SG have child (Gb)-PL 3PL. Gb-four
 ‘I have four children’

In sentence (1) above, (1a) displays agreement between the numeral a-naase ‘four’ and the noun bʊna (cl.3) ‘goats’. Noun class membership is not reflected in agreement as shown

above, (tasa (CL.1) ‘languages’ triggers **Ga** in (1b) and **bise** (CL.1) ‘children’ triggers **Gb** in (1c).

In conclusion, it is clear that, in Chakali grammar, gender peculiarity divides the nominals into a set of lexemes (a) – human and a set (b) + human. It is against this background that any attempt at distinguishing the noun classes by looking at agreement archetypes will yield to no success.

2.4.6 Bantu class prefixes: Inflectional or derivational?

The purpose of this sub-section is to explore the variation of noun class memberships prevalent in Bantu languages so as to determine whether the noun class prefixes are inflectional or play a role as derivational markers. Mufwene (1980: 246) specifies that the noun class membership is identified through a particular prefix which the noun must take and which governs a number of concord prefixes of adjectives, quantifiers, connectives and verbs that depend on the head noun they delimit. Mufwene argues that Bantu noun class prefixes have mostly been attributed a number-inflectional role, as is illustrated with pairs of prefixes in (1).

1.	Prefixes	Class
	mu- / ba-	1/2
	mu- / mi-	3/4
	li- / ma-	5/6
	ki- / bi-	7/8
	N- / N-	9/10
	lu- / N-	11/10
	lu- / tu-	11/13
	lu- / ma-	11/6
	ka- / tu-	12/13
	ka- / bu-	12/14

Schaderberg (2001: 8) provides a reconstructed Proto-Bantu system of noun classes, and utilizes the following abbreviations: NPx = Nominal Prefix; APx = Adjectival Prefix; PPx = Pronominal prefix, as is shown in (2) below.

2.	NPx	APx	PPx		NPx	APx	PPx	
1	MU	mu	yu, a, mu	—	Wa	wa	wa	2
3	MU	mu	u	—	MI	mi	i	4
5	JI	ji	li	—	MA	ma	ya	6
7	KI	ki	ki	—	VI	vi	vi	8
9	N	N	i	—	N	N	zi	10
11	U	mu	u					
15	KU	ku	ku					
16	-ni	pa	pa					
17	-ni	ku	ku					
18	-ni	mu	mu					

- Bantu Class Prefixes as Derivational

Schaderberg (2001: 15) is of the view that the formation of singular and plural forms, in Bantu noun classes, are derivational processes and play no separate role in controlling agreement. Mufwene is in consonant with the idea that class prefixes are numbered, play a derivational role, and utilizes MASS abstract nouns that are derived from adjectives so as to demonstrate this. The examples in (3) illustrate this argument.

3.	Adjectives		Nouns
(a)	-réfu	‘long’	u- réfu ‘length’
(b)	-kúbwa	‘big’	u- kúbwa ‘size’
(c)	-káli	‘sharp’	u- káli ‘sharpness’
(d)	-pána	‘wide’	u- pána ‘width’
(e)	-lévi	‘drunk’	u- lévi ‘drunkenness’

Mufwene specifies that the only mark of the abstract nominal derivations is the prefix u-, as it does not only delimit the stems, but, is actually the main carrier of the feature MASSness that

is now added to the meanings of the original adjectives. He further provides examples of noun- vs –noun derivational pairs, as is shown in (4-7) below.

4.	Kikongo				
	I		II		
	(a)	mu-/mi-sénzi	‘indigenous’	bu- sénzi	‘indigeneity’
	(b)	Ø-/ ba-mpángi	‘relative’	ki- mpángi	‘kinship’
	(c)	Ø-/ ba-bakála	‘man’	ki- bakála	‘maleness’
	(d)	Ø-/ ba-mvwáma	‘wealthy man’	bu- mvwáma	‘wealthiness’
	(e)	mu-/ ba-lúba		ki-lúba	
5.	Lingala				
	I		II		
	(a)	Ø-/ ba-ndeko	‘relative’	bo-ndeko	‘kinship’
	(b)	Ø-/ ba-mbanda	‘loverival’	bo-/ki-mbanda	‘love rivalry’
	(c)	Ø-/ ba-sodá	‘soldier’	ki-sodá	‘military service’
6.	Swahili				
	I		II		
	(a)	m-/ wa-tóto	‘child’	u-tóto	‘childhood’
	(b)	Ø-/ Ø-bába	‘father’	u- bába	‘fathership’
	(c)	Ø-/ m-adúi	‘enemy’	u-adúi	‘enmity’
7.	Yansi				
	I		II		
	(a)	ó- / á-káár	‘woman’	é-káár	‘femininity’
	(b)	ó- / á-ngáám	‘slave’	é-ngáám	‘slavery’
	(c)	ó- / á-yánsí	‘Yansi tribesman’	é-yánsí	‘Yansi language’

There are three interpretations that may be assumed in regard to the above examples, according to Mufwene. First it can be assumed that column -I items are more basic than those of column -II. Thus , the latter, can be defined as quality typical of X (nouns). Secondly, it can be assumed that column -II items are semantically more basic. Thus, column -I items may be treated as derivatives with the general meaning exhibiting quality X. Thirdly, it may well be

assumed that both column –I and –II items are derived from a neutral meaning of the same stem and that only their prefixes add the particular interpretations assigned to the noun, according to Mufwene. Looking at the assumptions provided, by Mufwene, the overriding idea is that the prefix seem to be the main identificational mark of the derived stems.

In conclusion, the hypothesis that noun class prefixes assume a derivational function in nouns, has some merit based on the evidence provided above. In Proto-Bantu languages the addition of the class prefixes to roots/stems of word categories seem to be the determining factor in deriving nouns. It is clear from the data provided above that, gender is not a determining factor of noun classes in Proto-Bantu languages.

2.4.7 The semantics of Bantu noun classification

The first approach is Richardson's (1967) approach, which is widely cited as an example of the position that class allocation is arbitrary, and is often deemed unworthy of serious consideration for that reason, according to Dingemanse (2009: 1). The second approach is by Palmer and Woodman (2000), whose main focus is on the cultural linguistic outlook of Shona noun class 3. The third approach is by Selvik (2001), who according to Dingemanse, explores three Setswana noun classes as polysemous categories in a Langeckerian fashion.

- Linguistic evolution and Bantu noun class system

Dingemanse (2009: 3-6) in summing up Richardson's (1967) arguments, states that, firstly, Richardson holds the view that the semantic organization that can be discerned in Bantu noun classes is the result of a recent analogical classification of the Proto-Bantu system which probably was arbitrary, and acknowledges that today's Bantu noun class system are suggestive of semantic organization. Secondly, that the influence of certain semantic factors, such as the generalization that holds that across Bantu the 1/2 gender denotes human beings, and that 12 /13 gender (where it occurs) carries a diminutive sense; the phonological factors, such as the allocation of certain classes to words because of their phonological form (e.g. ubu-langeeti / ama-langeeti 14/16 'blanket'), and sociolinguistic factors like the use of a 9a / 6 gender by the Bemba speakers to conform to urban usage, all these play a role in variation and cannot be denied.

Dingemanse mentions that the reason for Richardson's skepticism towards hypotheses regarding the correlation of classes and conceptual categories may be sought in his implicit assumption that a noun class can only be 'really' semantically motivated if it is governed by one 'overarching' notion, a general category of meaning.

- Ontological classifiers as Polycentric categories.

Dingemanse (2009: 6) cites Palmer and Woodman (2000) whose semantic analysis of noun class 3 in Shona puts emphasis on the role of cultural scenarios in noun classification, in addition to more widely recognized classifying criteria like material substance, physical shape, and other qualities. Palmer and Woodman introduced a set of eight principles for understanding the semantic structure of noun classes, so as to be in line with the complexity of Shona noun class 3, according to Dingemanse. The following are the eight principles: Multiple central models, Multiple prototypes, Chaining of central models of metonymy, Radial categories, Primary schematization, Secondary schematization and extension, end-point transformation, and Extension of concepts to human behaviour.

Dingemanse (2009: 8) indicates that the method used by Palmer and Woodman consists of devising a network of probable conceptual links out of a large collection of Shona class 3 nouns, and that these nouns are culled from the (1984) Standard Shona Dictionary by Hannan, and are not exhaustive nor is it a random sample. They are not clear on the method underlying the conceptual links they propose, as they sketch a complex category consisting of a network of radial categories connected to each other by various motivated (i.e non-arbitrary) links. Dingemanse specifies that an important virtue of this analysis lies in the fact that it provides an explanation of the seeming irregularity of Shona noun class 3. Palmer and Woodman hold that such a type of analysis can be extended to other Bantu noun class system. Dingemanse suggests that the fundamental weakness of Palmer and Woodman's study is that its claims are quite hard to verify empirically.

The various ways of providing suggestions that go beyond the limitations provided by Palmer and Woodman in their claims on how to analyze Shona class 3 nouns, is provided by Dingemanse. He notes that a substantial number of Shona class 3 nouns is fully or partially reduplicated, as is illustrated in (1).

1.

murambaramba	long, drawnout object
mukushakusha	rain driven slantingly by the wind
mutimuti	repetition of action
musakasaka	rain shower

Dingemanse cites Contini-Morava (1994, 1996) who advanced the notion that agreement patterns in discourse can throw light on the semantics of a class prefix, and as such this can be utilized by looking at the actual usage to investigate claims made by Palmer and Woodman. Lastly, the psycholinguistic experimentation could shed some light if native speakers could be asked to construct deverbal nouns from aspecified list of corresponding verb, according to to Dingemanse.

- A polysemy analysis of three Tswana noun classes

Dingemanse (2009: 12) points out that Selvik (2000) starts from the premise that the pervasive obstacle for semantic analyses of Bantu noun classes is the semantic diversity many classes exhibit. Selvik chooses classes 3, 5, 7 and 9 and advances that these classes exhibit the highest degree of semantic heterogeneity. Selvik makes use of Langacker's (1987) notion of schematic network, and indicate that each of the classes has exactly one prototype: 'tree' for class 3, 'fruit' for class 5, and 'instrument' for class 7. These prototypes are connected by relationships of various types called class schemas, and the class schemas relate to the prototype of a class by way of relationships of extension or instantiation, according to Selvik.

Dingemanse highlights the similarities between Selvik' s approach, which utilizes Langacker's (1987, 1991a) schematic network, and that of Palmer and Woodman (2000) who base their analysis on Lakoff's (1987) notion of radial category. Selvik' s approach provides a cross-linguistic overview of semantic principles in gender systems of many languages, and also involves a psycholinguistic experiment to test the predictions generated by her analysis, according to Dingemanse. Selvik designed two sets of test-items, both based on the principle of correlating nonce words + class prefixes with pre-determined meanings, presented to seventy-eight native speakers of Setswana, as is illustrated in (2) below:

2. (a) serutsa 'a small, round ball'
'a tree that grows in Europe'

prefixes that they take. She also notes that there are languages where suffixation also occurs in Bantu nouns, as is illustrated in (1) below:

1. (a) Agentive nominalizing -rimyi ‘cultivate’ (-rim- cultivate)
 Suffix -yi -vunyi ‘protector, helper’ (-vun- protect, defend’)
- (b) Locative/instrumental nominalizing suffix -o -báago ‘abattoir’ (báag- slaughter)
 -sékuro ‘mortar’ (-sékur- pound)
 - sékuzo ‘pestle’

Katamba emphasizes that it is prefixation that can be regarded as the hallmark of Bantu nominal morphology, as is demonstrated by the Nyakore sample pairings of the noun stems with the prefixes mu-/ba, ki-/bi- and N/N to mark number, as in (2) below:

2.		Singular		Plural
	Class a	mu-ntu	‘person’	ba-ntu
	Class b	ki-rabyo	‘flower’	bi-rabyo
	Class c	m-bwa	‘dog’	m-bwa

2.5.1 History of noun classification

The history of noun classification revolves around the notion of prefixation being paramount in determining derivation, according to Katamba. Katamba refers to Mufwene (1980) who had claimed that derivation is the primary role of noun class prefixes in Bantu, as is shown in the examples in (3) below:

3. (a) ∅- mpáangi ‘relative’ : ki-mpáangi ‘kinship’
- (b) mu-kóngo ‘Kongo person’ : ki- kóngo ‘Kongo language’

Katamba suggests that the noun class prefix, in many Bantu languages, may be preceded by another formative which is referred to as the augment (or the pre-prefix or the initial vowel). de Blois (1970) as cited by Katamba, claims that the augment varies considerably both in its shape and function. Katamba claims that many scholars have incorrectly equated the augment with the article in European languages, such as Bleek (1869) had claimed that though the

initial vowel in Xhosa was originally a pronoun, it had evolved into an article. Katamba (2003) cites Hyman and Katamba (1991, 1993) who have shown that in Ganda the augment may serve a range of functions, and cannot be equated with a determiner, but, can play the pragmatic role of indicating definiteness, specificity or focus, as is shown in (4) below:

4. Ganda augment
 ò -mú- límí ó- mú- n

2.5.2 Concord

Katamba claims that noun class prefixes are at the heart of an extensive system of concord (i.e. agreement) in Bantu, as seen in the Swahili data in (4):

4. (a) M-toto m-dogo a-mefika ‘The little child arrived’
 cl. 1 child cl. 1 little cl. 1 arrived
- (b) Ki-kapu ki-dogo ki-mefika ‘The little basket arrived’
 cl. 7 basket cl. 7 little cl. 7 arrived

She argues that the fact that in some cases it is an identical shape that is prefixed, as in the case of class 7 **ki- ki- ki-**, prompted linguists to speak of ‘alliterative concord’, but, as the first example with prefixes **m- m- a-** shows, concord need not be alliterative. Katamba demonstrates using Meeussen’s (1967) concord patterns that each class prefix has a form that appears with words belonging to the following classes:

5. nominal prefix (NP) in nouns, locatives and adjectives;
 numeral prefix (EP) in words for <<1-5 and <<how many;
 pronominal prefix (PP) in substitutives, connectives, possessives,
 demonstratives, determinatives, (<<other, <<which, etc.) and relative verb
 forms; verbal initial prefix (VP) in absolutive verb forms;
 verbal pre-radical prefix (infix) in verb forms; the infix has, besides persons
 and classes, a reflective form.

The concordial system in Ganda can be shown with different adnominal concords that go with the noun, as in (6) below:

6. (a) Noun + Adjective
 muti munene 'big tree'
 tree big
- (b) Noun + Demonstrative
 muti guno 'this tree'
 tree this
- (c) Noun + Numeral
 mutí gumû 'one tree'
 tree one
- (d) Noun + Associative construction
 muti gwá (< gu + á) múkázi 'woman,s tree'
 tree of woman
- (e) Subject
 (o +) muti gu- li- gwa 'the tree will fall'
 tree subj-fut-fall
- (f) Object
 (o +) muti tu- li- gu -tema 'we will chop the tree'
 tree we-fut.obj.chop

2.5.3 Gender conflict resolution

Katamba (2003: 113) cites Heine (1982: 194-5) who observed that there appear to be two basic principles in allocating nouns to particular genders and assigning agreement markers to them. Gender may be assigned on the basis of semantic criteria like sex: masculine nouns and feminine nouns, according to Katamba. Katamba further states that Bantu languages show both semantically motivated and mechanical agreement, as is illustrated in Swahili agreement in (7) below:

7. (a) ki-boko m-kubwa 'large hippo'
 cl. 7 –hippo cl. 1 –large

- (b) ki-durango m-bingwa 'clever dwarf'
 cl. 7 –dwarf cl. 1 –clever
- (c) ki-tabu ki-kubwa 'large book'
 cl. 7 –book cl. 7 –large

Katamba refers to Heine (1982) who makes a distinction in regard to the choices Swahili speakers have between semantic and mechanical agreement with animate nouns of the augmentative (5/6) and diminutive (7/8) classes. It is suggested by Katamba that if a coordinate noun phrase contains nouns belonging to the same class, the corresponding plural prefix is used, but, coordination raises problems for gender agreement when nouns belonging to different classes are involved. Katamba points out that in Haya, if one of the nouns refers to a human and the other to an animal, a class 2 human concord is required in the plural, as is illustrated in (8) below:

8. (a) omusháíja n' émbwá bá- á- genda 'the man and dog went'
 Man and dog they-past-go (cl. 2 sm)
- (b) * omusháíja n' émbwá zá- á- genda (cl. 10 sm)

According to Katamba, coordination is avoided in situations where there is a gender conflict involving human and non-human nouns in favour of comitative construction, as is illustrated in (9) below:

9. omusháíja y- áá- genda n' émbwá 'the man went with the dog'
 Man he-past-go with dog

Katamba specifies that the Haya gender resolution rules lack universality in so far as the Bantu nominals are concerned. Katamba cites Bokamba (1985: 45) who points out that Swahili has the verb agreeing with the nearest NP, thereby, yielding grammatical sentences, as is shown in (10) below:

10. (a) ki- ti na m-guu wa meza u-mevunjika
 7 –chair and 3-leg of table 3-be. Broken
 'The chair and the leg of the table are broken.'

- (b) guu wa meza na ki-ti ki-mevunjika
 3-chair of table and 3-leg 3-be.broken
 ‘The leg of the table and the chair are broken.’

2.5.4 Semantics of nouns classes

Katamba cites Richardson (1967: 378) who points out that the lack of a clear semantic basis for noun classification in contemporary Bantu reflects the situation in Proto-Bantu. Scholars like Denny and Creider (1986) have tried to provide a sound methodology and coherence, notwithstanding, the chaos of the semantics of noun classes. This, they have done by associating the majority of PB noun prefixes with a particular configurational or shape meaning, according to Katamba.

Contini-Morava (1997) used the framework of cognitive linguistics in their analysis of the semantics of noun classes. This is in line with earlier studies undertaken by Denny and Creider. Katamba points out that in cognitive grammar the traditional class membership can be justified on the basis of multiple criteria, including family resemblance, metaphor, metonymy, etc. The multiple criteria provided for in cognitive grammar is regarded by skeptics as being cumbersome, as it fails to account for the gender of many abstract nouns, such as *mbisho* ‘strife’ argumentativeness, *mkano* ‘denial’, according to Katamba.

Katamba highlights Moxley’s (1998) approach on the semantic analysis of Bantu nouns where she utilizes Lakoff’s (1987) cognitive approach, by supporting previous analysts, thereby, observing that 3/4 gender contains the majority of nouns referring to trees and plants, as is shown in (11) below:

11.	Class 3	Class 4	
(a)	plants		
	mti	miti	‘tree’
	mkindu	mikindu	‘palm tree’
	mpingo	mipingo	‘ebony tree’
(b)	plant parts		
	mzizi	mizizi	‘root’
	mbegu	mibegu	‘seed’

(c)	made from plants		
	mkeka	mikeka	‘mat’
	mkate	mikate	‘bread’

Katamba points out that there is a substantial number of concrete nouns, abstract nouns, various nominalizations, etc. in class 3 which cannot be accounted for in terms of Moxley’s cognitive approach, as can be illustrated in (12) below:

12.	mbwoji	‘spring (of water)’
	mchanganyiko	‘mixture’
	mwanya	‘gap, hole’
	mchuzi	‘gravy’
	mdahalo	‘debate, discussion’
	mwongo	‘number, account’

In conclusion, Katamba has demonstrated that the noun class prefixes play a crucial role in the extensive system of concord i.e agreement in Bantu languages. The classification of nouns into genders on the basis of noun class prefixes and concords has shown a trait that is endemic in this language group. The problem associated with gender conflict resolution, such as the one caused by coordination, in respect of nouns belonging to classes other than those referred to by Heine, was solved using the avoidance strategy though it was suspicious as it lacked universality.

2.6 CONCLUSION

This chapter has shown that most linguists employ a descriptive method in determining deverbal nominals in most languages. The classification of nouns in terms of a class system has been shown to be fundamental in determining the derivation of each noun. Burton and Kirk (1976) pointed out that the syntactic function of Bantu noun class is clear but less obvious is the semantic status of noun classes. Poulos and Msimang (1998) have demonstrated the descriptive nature of Zulu nouns by illustrating the various denotations of deverbatives. It has been shown that in most cases the emphasis in regard to deverbatives has been on their morphology, as is also shown by Ziervogel and Mabuza (1976) who focused on the prefixation and suffixation of Siswati deverbal nominals.

Poulos (1990), Baumbach (1987) and Krüger (2006) regarded noun classes as being pertinent in determining the semantic value of Venda and Setswana deverbatives, respectively. In the semantics of noun classes in Proto-Bantu, Denny and Creider (1986) demonstrated that the noun class prefixes are associated with configurational or shape meaning in most cases. In Chakali grammar emphasis was placed on the gender peculiarity which divided the nominals into a set of lexemes (a) –human and a set (b) + human. Schaderberg (2001) is consonant with the idea previously enunciated by Mufwene (1980) that Bantu noun classes are derivational in character. On the other hand, Katamba (2003) viewed prefixation as the hallmark of Bantu nominal morphology.

CHAPTER 3

THE GENERATIVE LEXICON THEORY

3.1 INTRODUCTION

In this chapter, the fundamental problem associated with the semantics of words, is explored, particularly, the problem of compositionality. The theoretical paradigm used to examine these issues is, Pustejovsky's (1996), Generative Lexicon Theory. Pustejovsky contends that the problems for lexical semantics are concerned with explaining the polymorphic nature of language, characterizing the semanticity of natural language utterances, capturing the creative use of words, and developing a richer, co-compositional semantic representation. He argues that there are two assumptions that play a crucial role in a lexical semantic framework: the first being appreciation of syntactic structures, and the second being the notion that the semantics of natural language should be the image of nonlinguistic conceptual organizing principles whatever their structure.

The semantic type plays a crucial role in a word's meaning, as the categorial type is not merely concerned with what the elements of the category refer to, according to Pustejovsky. He groups the meanings of words into semantic classes so as to study the syntactic patterns that words participate in, and discusses the semantic classifications for verbs, and the aspectual classes, or Aktionsarten. The main focus behind the classification concerns the issue of eventualities. Nominal alternations are investigated so as to determine their distinct behaviour. The semantics of agentive nouns are also investigated, since they are characterized in terms of events, as discussed by Busa (1996).

In developing his generative lexical semantic approach, Pustejovsky explores two dimensions of the problem of lexical ambiguity and then examines the simplest lexical model that is able to account for these phenomena, the notion of contrastive ambiguity and complementary polysemy. The problem of polysemy is investigated within the context of Sense Enumerative Lexicon (SEL), where two distinct approaches are utilized; the primitive-based theory, and the relation-based theories.

This chapter deals with the fundamental problems associated with the semantics of words, particularly, the problem of compositionality. In natural language semantics, formal theories have dealt with the problems associated with the meaning of words in a superficial manner, and falling short in examining the innovative use of words in different contexts, and failing to deal with compositionality. The theoretical paradigm employed to explore these issues is, Pustejovsky's (1996), Generative Lexicon Theory.

This chapter is organized into six sections for presenting an overview of Generative Lexicon Theory. Section 3.1 contains the introduction, section 3.2 explores the nature of lexical knowledge, section 3.3 explores the goals of lexical semantic theory, 3.4 examines the semantics of agentive nominals, section 3.5 explores the individual-level and stage –level deverbal nominals: event structure properties, and, thereafter, section 3.6 which contains the concluding remarks.

Section 3.1 is the introductory part which outlines the important issues identified by Pustejovsky (1996), that have received little attention in formal theories of natural language semantics. This is done by briefly explaining the pertinent issues associated with the problems of lexical semantics in the different sections of this chapter.

The following part section 3.2, will provide details of Pustejovsky's views regarding the nature of lexical knowledge. This section also investigates the notion of multiple listing of words in the lexicon. Section 4 examines the semantics of nominals, where the argument structure, event structure and qualia structure are investigated within the Generative Lexicon model. This section also investigates the link between nominalization and events, and also looks at the contribution of Generative Lexicon theory to the study of nominalization.

In section 3.5, the research on events in linguistic theory is explored. There is also a detailed examination of the distinction between stage-level and individual-level nominals. This section examines the generative lexicon devices relating to the semantics of nominals. These devices are looked at so as to determine how they contribute towards a classification of the different nominal types.

3.2 THE NATURE OF LEXICAL KNOWLEDGE

This section discusses Pustejovsky's views that the structural information of a sentence is best encoded from a lexicalized perspective, and examines the importance of semanticity in lexical semantics. It considers the semantic classes and categorial alternations as these aspects are very crucial in determining the senses of lexical items. Pustejovsky (1996: 5) explains that the fundamental problems for lexical semantics are the following:

- (a) Explaining the polymorphic nature of language;
- (b) Characterizing the semanticity of natural language utterances;
- (c) Capturing the creative use of words;
- (d) Developing a richer, co-compositional semantic representation.

Pustejovsky (1996) considers two assumptions that play a crucial role in a lexical semantic framework. The first is that, the study of lexical semantics is bound to fail if it does not appreciate syntactic structures of a language. The second point is that, the semantics of natural language should be the image of nonlinguistic conceptual organizing principles, whatever their structure.

According to Pustejovsky (1996:6), there are basically three principles that should guide computational lexical semantics. First, a clear notion of semantic well-formedness is necessary in order to characterize a theory of possible word meaning. Secondly, lexical semantics must look for representations that are richer than thematic role descriptions, where Pustejovsky refers to the work of Gruber, (1965), Fillmore, (1968). Thirdly, lexical semantics must study all syntactic categories in order to characterize the semantics of natural language.

Pustejovsky (1996: 8) contends that the semantic type is the most fundamental aspect of a word's meaning, and that categorial or type information determines not only how a word behaves syntactically, but also what the elements of the category refer to. For example, the verbs **love** and **hate** would be viewed as relations between individuals in the world, while the noun **woman** would pick up all individuals in the world who are women. Pustejovsky maintains that lexical semantics distinguishes selectional subsets of members of particular categories. For example, **dog** and **book** partition into different selectional classes, such as animacy for **dog**, whereas **book** and **literature** partition into different selectional classes due

to a mass / count distinction, he refers to previous studies by Verkuyl (1972), Pelletier and Schubert, (1989).

3.2.1 Verbal Alternations

Pustejovsky (1996: 8) points out that the linguistic methodology for grouping the meanings of words into semantic classes compels one to study the syntactic patterns that words participate in (e.g., common grammatical alternations). Pustejovsky (1996) cites Levin (1993) in outlining a broad classification of verb argument alternations in English, in order to classify verbs into semantically unique classes. The verbs such as **sink**, roll, and **break** have both transitive and intransitive form:

1. (a) The ship sank in the ocean.
(b) The submarine sank the ship in the ocean.
2. (a) The glass broke suddenly.
(b) Wendy broke the glass suddenly.

Pustejovsky (1996: 9) suggests that lexical semantics should specify what is it that the two classes share, such that they have grammatical intransitive forms. Other useful alternation patterns include the conative, as is shown in (3) – (4).

3. (a) Joseph shot the lion.
(b) Joseph shot at the lion.
4. (a) The dog touched my leg.
(b) *The dog touched at my leg.

Pustejovsky contends that the examples above show that participation in one grammatical alternation does not sufficiently determine the semantic class of the verb, and that the alternation classifications do not constitute a theory. This view is supported by Levin (1993), when she pointed out that the theoretical mechanisms which give rise to the descriptive distribution of syntactic behavior are not transparent in the classes by themselves. Pustejovsky (1996: 9) examines polyadicity which is another kind of syntactic diagnostic that seems to have some theoretical utility. He refers to Bresnan (1982), Fillmore (1993), and Levin (1993)

who regard such arguments not only as argument changing alternations, but also as argument dropping alternations. Consider the examples in (5) – (6) where this rule of “indefinite NP deletion” is shown in the alternations.

5. (a) The boy ate his lunch quickly.
 (b) The boy ate quickly.
6. (a) The tiger consumed the little antelope.
 (b) *The tiger consumed.

Pustejovsky (1996) cites Fillmore (1986), who points out cases where near synonyms seem to behave differently with respect to licensing of complement –drop (cf. (7) – (8)).

7. (a) Elizabeth tried to clean the house in the afternoon.
 (b) Elizabeth tried in the afternoon.
8. (a) Elizabeth attempted to clean the house in the afternoon.
 (b) *Elizabeth attempted in the afternoon.

Pustejovsky specifies that in addition to transitive-intransitive polyadicity, there are well documented ditransitive-transitive shifts such as those shown in (9) – (12) below, where the obligatory expression of the goal argument is dropped, and the verb becomes a simple transitive.

9. (a) Magaret gave a letter to the children.
 (b) *Magaret gave a letter.
10. (a) Magaret gave a lesson to the children.
 (b) Magaret gave a lesson.
11. (a) Isaac mailed a book to his child.
 (b) * Isaac mailed a book.
12. (a) Isaac mailed a letter to his child.
 (b) * Isaac mailed a letter.

Pustejovsky (1996:12) discusses the oldest semantic classifications for verbs, that of aspectual class or *Aktionsarten*. The fundamental aspect behind this classification concerns the fact that

verbs and verb phrases differ in the kinds of eventualities in the world they denote. He states that there are at least three aspectual types:

- (i) State (sick, know, love, think)
- (ii) activity (walk, run, swim, drink)
- (iii) event
 - Accomplishment (build, destroy, break)
 - Achievement (die, find, arrive)

Pustejovsky points out that the verb **walk** in sentence (13) denotes an activity of unspecified duration.

- 13. (a) Priscilla walked on Friday.
- (b) Priscilla walked to work on Friday.

He states that in (13a) the sentence above denotes an activity, and sentence (13b) conveys the same meaning as (13a), with the additional constraint, however, that Priscilla terminated her activity at her work. This type of sentence is said to denote accomplishment according to Pustejovsky. The creation verbs like **build** and **destroy** also denote accomplishment events because there is a logical culmination to the activity performed, as is illustrated in (14).

- 14. (a) David built a house.
- (b) The lion destroyed the cattle.

Pustejovsky (1996: 13) suggests that *performance verbs* such as **play** permit both activity usage (15a) and accomplishment usage (15b), depending on the complement structure:

- 15. (a) Jane played the guitar (for days).
- (b) Jane played the sonata in 10 minutes.

Pustejovsky (1996) states that modification by temporal adverbials such as **in an hour** assist in testing whether a verb or verb phrase denotes an accomplishment. He considers sentences (16) – (17) where both the derived and lexical accomplishments license such a modification.

16. (a) Irene walked to work in an hour.
 (b) Irene built a flat in six months.
17. (a) *David drank in 10 minutes.
 (b) *Monica worked in an hour.

Pustejovsky (1996:14) explains that the adverbial frame seem to require that the verb or verb phrase make reference to an explicit change of state, a precondition missing in (17).

Pustejovsky examined the aspectual classification of achievement, and defined achievement as an event that result in a change of state, just as an accomplishment does, but where the change is thought of as occurring instantaneously. He considers the sentences in (18) where modification by point adverbial such as **2 am** is suggestive that a sentence denotes an achievement (cf. Dowty, 1979).

18. (a) Alfred died at 2 am.
 (b) Mavis found her purse at 2 am.
 (c) Dorothy arrived at midnight.

Pustejovsky points out that lexical properties of the verb can be affected by factors that could not possibly be lexical. He considers the sentences in (19) – (20) below, where this notion is illustrated.

19. (a) Jingles ate sausage. (activity)
 (b) Jingles ate a sausage. (accomplishment)
20. (a) Murray and Roberts Inc. built the Olympic stadium in Atlanta.
 (b) Murray and Roberts Inc. builds Olympic stadiums in Canada.

According to Pustejovsky in (19) above, there is a shift in the meaning of **eat** from an activity in (19a) to an accomplishment in (19b). Pustejovsky mentions that in (20b) the presence of a bare plural object shifts the interpretation of a typical telic (or completive) event to an unbounded process.

Pustejovsky completes his discussion of aspectual classifications by examining the behavior of states, and distinguishes two kinds of stative predicates, *individual – level* and *stage – level*. Pustejovsky mentions that predicates such as **tall**, **intelligent** and **overweight** are properties that an individual retains, hence, these predicates are classified as individual – level predicates. Properties that cannot be retained by an individual, such as **hungry**, **sick**, and **clean**, these predicates are classified as stage – level predicates. Consider the sentences in (21), illustrating the stage - level predicates, whereas, the individual - level predicates can be illustrated by the examples in (22), below .

21. (a) Davon became sick after the athletic season.
 (b) Passing next to Macdonald made Eric hungry.
 (c) Bob kept his room clean only for a moth.
22. (a) *Russell abandoned physical exercises and became overweight.
 (b) *Moses is a tall fellow.

3.2.2 Nominal alternations

Pustejovsky (1996: 17) regards *count* versus *mass nouns* as probably the most studied distinction for nominal semantics. He draws a distinction between two nouns, **sand**, though it is composed of individual grains, is a mass noun, and a **house**, an individuated object, is classified as a count noun. In the generative lexicon it is stated that count nouns and mass nouns select for different quantifier types and allow very different patterns of predication, as in (23) below.

23. (a) MASS NOUNS: much sugar, more milk
 (b) COUNT NOUNS: several teams, every player.

Pustejovsky (1996) makes reference to nouns that display a both mass and count interpretation, nouns such as **beer** and **e-mail**, illustrated in the examples in (24) – (25) below.

24. (a) Students drank a lot of beer.
 (b) Patrick enjoyed every beer he drank.

25. (a) The dean sent *e-mail* to all staff members today.
 (b) *More e-mail* is arriving from the dean today.

Pustejovsky specifies that a semantic distinction related to count and mass nouns is that between individual and group nouns, and that group nouns satisfy semantic plurality requirements on selection, as is shown in (26) below.

26. (a) The university council *met* on Saturday.
 (b) The crowd *dispersed* after a warning from the police.

Pustejovsky outlines the issue of relational nouns that are dependent on another referent in terms of how they themselves denote. Nouns such as, *neighbor* and *brother* denote individuals standing in relation to at least one other individual in specific ways. He considers the sentences in (27) – (28), where the relational notion is illustrated.

27. (a) The players arrived today.
 (b) ?The neighbor arrived today.
 (c) The neighbors arrived today.

Pustejovsky (1996: 18) explains that nouns such as *neighbor* and *sister* denote horizontal relations, while *father* and *daughter* denote hierarchical relations, and that contextual salience improves the acceptability of these NPs, as is shown below.

28. (a) *The daughter is at home.
 (b) ?The daughters are gathering upstairs.
 (c) The elders are meeting today.

Pustejovsky elaborates by stating that explicit mention of the independent variable in the relation results in fully acceptable sentences:

29. (a) My daughter has left for school.
 (b) Deon's brother is a magician.
 (c) My neighbor lent me a lawnmower.

Pustejovsky concludes by indicating that a more traditional method of nominal classification is based on taxonomies of speaker's intuition or common sense perspective of what the nouns denote in the world. In the generative lexicon a distinction is made between concrete referring nouns such as **man, girl, dog** (all count nouns), as well as **grass, sand, water, and diamond** (mass nouns) and abstract referring nouns such as **time, wind, age, space, and shape**.

3.2.3 Interlexical relations

The relationship between lexical items has received special attention in lexical semantics. Pustejovsky (1996:23) examines five classes of lexical relations:

- (i) synonymy
- (ii) antonymy
- (iii) hyponymy and lexical inheritance
- (iv) meronymy
- (v) entailment and presupposition

Pustejovsky (1996) outlines that the standard definition of synonymy which states that two expressions are synonymous if substituting one for the other in all contexts does not change the value of the sentence where the substitution is made. The standard definition ignores the issue of opacity and substitutability in opaque contexts. Crystal (1987:213) explains that in semantics, the notion of referential opacity applies to a construction or context which fails to preserve its truth-functional status when substituted by certain types of CO-REFERENTIAL expression. There are instances where synonymy is defined in terms of substitutability of expressions and is regarded as an intra-category relation as in the substitution of nouns for nouns, verbs for verbs.

According to Pustejovsky, antonymy like synonymy, is properly defined over pairs of lexical items rather than concepts and is characterized in terms of semantic oppositeness. He refers to the following to illustrate the examples of antonymy; **rise/fall, heavy/light, fast/slow, long/short**. He regards meronymy as being difficult to define, but, however, it is regarded as the relation of parts to the whole.

Pustejovsky (1996:24) distinguishes between entailment and presupposition by stating the following: An expression A semantically entails an expression B if and only if every situation that makes A true, makes B true. On the other hand, A semantically presupposes B if and only if both (a) in all situations where A is true, B is true, and (b) in all situations where A is false, B is true. He refers to the following examples illustrate entailment relations, the sentence in (41a) entails the proposition denoted by the corresponding sentence (30b):

30. (a) John killed Bill.
 (b) Bill died.
 (c) Bill is dead.

Pustejovsky provides the following examples illustrating presupposition relations, the sentence in (31a) presupposes the proposition denoted by the corresponding sentence (31b):

31. (a) Mary managed to finish the exam.
 (b) Mary finished the exam.

3.2.4 The logical problem of polysemy

Pustejovsky asserts that the semantic behaviour of deverbal nominals tends to display an ambiguous character most of the time. The notion of ambiguity, often referred to as polysemy, has received special attention within the paradigm of Generative Lexicon . Andersen (2007:57) outlines that in generative lexical semantics, specific core sets of word senses are seen as having great internal structure and are used to generate larger sets of word senses when individual lexical items are combined with others in phrases and clauses. In generative lexical semantics, Pustejovsky (1996:27) explores two dimensions of the problem of lexical ambiguity and then discusses the simplest lexical model that is able to account for these phenomena.

In treating the varieties of sense extension as a notion of polysemy, Pustejovsky (1996) assumes Weinreich's (1964) method of distinguishing ambiguity, the first being contrastive ambiguity (often referred to as homonymy) and the second known as complementary polysemy. In Pustejovsky and Buguraev (1996:2) contrastive ambiguity is defined as the situation where a lexical item is associated with at least two distinct and unrelated meanings.

The following examples illustrate contrastive ambiguity:

32. (a) Mary walked along the bank of the river.
 (b) HarborBank is the richest bank in the city.
33. (a) Drop me a line when you are in Boston.
 (b) We built a fence along the property line.

The examples in (32) – (33) demonstrate that the underlined lexical items have more than one meaning. Following Weinreich (1964), Pustejovsky (1996) covers complementary polysemes which are manifestations of the same basic meaning of the word as it occurs in different contexts. He provides the following examples to illustrate this phenomena:

34. (a) The bank raised its interest rates yesterday.
 (b) The store is next to the newly constructed bank.
35. (a) John crawled through the window.
 (b) The window is closed.

In the examples in (32) – (35) above, the underlined lexical items, have not undergone any category change. Pustejovsky (1996) regards these sense distinctions as complementary polysemies.

- **Contrastive ambiguity**

Pustejovsky (1996:29) focuses on the factors that determine the disambiguation process for lexical items that have contrastive senses. Two aspects are examined that play an important part in determining word senses; abstract meaning and contextual meaning. He provides the following examples to illustrate this phenomena:

36. John shot a few bucks .
37. The student failed/drowned at school.
38. (a) Men are picking up sticks.
 (b) Men went to battle.

Thus, the verb **shoot** and the noun **bucks** are contrastively ambiguous. In sentence (37), the verb **drown** has two senses: **fail** and **drown**. The domain of discourse determines the difference in the meaning. In sentence (38), the lexical meaning of this sentence cannot be determined by a single word. The context determines the meaning of the whole phrase. Pustejovsky (1996) argues that lexical disambiguation does not occur independently for one lexical item, but rather, once the context or domain for one item has been identified, the ambiguity of the other items is also constrained.

In lexical disambiguation, there are instances that cannot be determined through abstract and pragmatic means. Pustejovsky (1996:30) asserts that such instances of lexical disambiguation come by virtue of the predication relation in the sentence and regards this a case of *sortally constrained disambiguation*. He provides the following examples in (39) to illustrate the source of ambiguity as being syntactic, as is shown below.

39. (a) The teacher talked with the student while he had books.
 (b) The police officer arrested a thief while running.

- **Complementary polysemy**

According to Pustejovsky, the process of lexical disambiguation cannot be looked at from a perspective of context and pragmatic information alone. Contextual priming and pragmatic information play a significant role in disambiguating contrastive senses. Pustejovsky (1996:32) maintains that context and pragmatic information are irrelevant in determining the sense of a logically polysemous noun. He states that sense alternation is one of the many nominal alternations that can be described as logical polysemies, where the noun seems to have systematically related senses. He considers the following examples to illustrate this phenomena:

- (i) Count / Mass alternations: [pig]
 40. (a) The pig is running from the dog.
 (b) The dog is barking the pig
- (ii) Container / Containee alternations: [bottle]
 41. (a) The young man finished the bottle.

- (b) The infant drank the bottle.
- (iii) Figure / Ground Reversals: [door]
42. (a) The door is broken.
(b) Bobby entered through the door.
- (iv) Product / Producer alternation: [bus]
43. (a) The bus collided with a car.
(b) The driver is driving the bus.
- (v) Plant / Food alternations: [apple]
44. (a) Marry ate an apple.
(b) The rain destroyed the apples.
- (vi) Place / People alternations: [Johannesburg]
45. (a) The students visited Johannesburg.
(b) Johannesburg is famous for its crime.
- (vii) Process / Result alternations: [vote]
46. (a) Voting will take place on a determined date.
(b) The citizens took part in voting.

Pustejovsky (1996) is of the view that although there seems to be some similarities between contrastive ambiguity and logical polysemy with regard to lexical disambiguation in terms of context, differentiation can be distinguished. He suggests that both senses of a logically polysemous noun seem relevant for the interpretation of the noun in the context, but one sense seems 'focused' for purposes of a particular context.

- **An elementary lexical semantic theory**

Pustejovsky (1996:34) is of the opinion that the problem for natural language semantics of assigning the correct semantic interpretation to sentences, can be accounted for by allowing the lexicon to have multiple listings of words. This can be done through a dictionary

formulated as a Sense Enumerative Lexicon (SEL) which Pustejovsky (1996) defines as follows:

A Lexicon L is a Sense Enumeration Lexicon if and only if for every word w in L, having multiple senses s₁, ..., s_n associated with that word, then, the lexical entries expressing these senses are stored as {s₁, ... , w_{sn}}.

Pustejovsky (1996) proposes a method whereby complementary senses are stored in a single entry, distinguished by sense-identification number. The following example illustrates this aspect.

47.	<table style="border-collapse: collapse; width: 100%;"> <tr> <td style="padding: 5px;">lamb</td> <td></td> </tr> <tr> <td style="padding: 5px;">SENSE₁ =</td> <td style="padding: 5px;"> <table style="border-collapse: collapse; margin-left: 20px;"> <tr> <td style="border-right: 1px solid black; padding: 2px 5px;">CAT = MASS-NOUN</td> <td style="padding: 2px 5px;">]</td> </tr> <tr> <td style="border-right: 1px solid black; padding: 2px 5px;">GENUS = meat</td> <td style="padding: 2px 5px;">]</td> </tr> </table> </td> </tr> <tr> <td style="padding: 5px;">SENSE₂ =</td> <td style="padding: 5px;"> <table style="border-collapse: collapse; margin-left: 20px;"> <tr> <td style="border-right: 1px solid black; padding: 2px 5px;">CAT = count-noun</td> <td style="padding: 2px 5px;">]</td> </tr> <tr> <td style="border-right: 1px solid black; padding: 2px 5px;">GENUS = animal</td> <td style="padding: 2px 5px;">]</td> </tr> </table> </td> </tr> </table>	lamb		SENSE ₁ =	<table style="border-collapse: collapse; margin-left: 20px;"> <tr> <td style="border-right: 1px solid black; padding: 2px 5px;">CAT = MASS-NOUN</td> <td style="padding: 2px 5px;">]</td> </tr> <tr> <td style="border-right: 1px solid black; padding: 2px 5px;">GENUS = meat</td> <td style="padding: 2px 5px;">]</td> </tr> </table>	CAT = MASS-NOUN]	GENUS = meat]	SENSE ₂ =	<table style="border-collapse: collapse; margin-left: 20px;"> <tr> <td style="border-right: 1px solid black; padding: 2px 5px;">CAT = count-noun</td> <td style="padding: 2px 5px;">]</td> </tr> <tr> <td style="border-right: 1px solid black; padding: 2px 5px;">GENUS = animal</td> <td style="padding: 2px 5px;">]</td> </tr> </table>	CAT = count-noun]	GENUS = animal]
lamb															
SENSE ₁ =	<table style="border-collapse: collapse; margin-left: 20px;"> <tr> <td style="border-right: 1px solid black; padding: 2px 5px;">CAT = MASS-NOUN</td> <td style="padding: 2px 5px;">]</td> </tr> <tr> <td style="border-right: 1px solid black; padding: 2px 5px;">GENUS = meat</td> <td style="padding: 2px 5px;">]</td> </tr> </table>	CAT = MASS-NOUN]	GENUS = meat]										
CAT = MASS-NOUN]														
GENUS = meat]														
SENSE ₂ =	<table style="border-collapse: collapse; margin-left: 20px;"> <tr> <td style="border-right: 1px solid black; padding: 2px 5px;">CAT = count-noun</td> <td style="padding: 2px 5px;">]</td> </tr> <tr> <td style="border-right: 1px solid black; padding: 2px 5px;">GENUS = animal</td> <td style="padding: 2px 5px;">]</td> </tr> </table>	CAT = count-noun]	GENUS = animal]										
CAT = count-noun]														
GENUS = animal]														

The combination of the two lexical representations has resulted in the modification of the definition of SEL so as to include this distinction in storing senses. Pustejovsky (1996:38) explains the modified definition of SEL in the following manner:

A Lexicon L is a Sense Enumeration Lexicon if and only if for every word w in L, having multiple senses s₁, ..., s_n associated with that word, then:

- (i) if s₁, ..., s_n are constrative senses, the lexical entries expressing these senses are stored as w s₁, ... , w_{sn}.
- (ii) if s₁, ..., s_n are complementary senses, the lexical entries expressing these senses are stored as w {s₁, ... , w_{sn}}.

Every ambiguity is either represented by (i) or (ii) above.

This modified SEL model, according to Pustejovsky (1996), has the advantage in that the lexicon remains a separate and independent component or source data, or a plug-in module

form the computational perspective. He states that although this SEL model is used by many researchers within both the theoretical and computational traditions, the model is inadequate for the purposes of linguistic theory.

3.3 THE GOALS OF LEXICAL SEMANTIC THEORY

In this section, Pustejovsky (1996:40) suggests that the goal of a theory of lexical semantics, and with it a compositional semantics, is to describe appropriately the data and to be transparent regarding the following two aspects:

- (i) The system must be learnable and
- (ii) The various phenomena of polymorphisms must be adequately addressed.

Pustejovsky (1996) introduces a notion of semanticity, equivalent to the view of grammaticality, first proposed in Chomsky's *Aspects of the Theory of Syntax* (1964). Semantically focuses on the semantic well-formedness of expressions in grammar whilst Chomsky's notion of grammaticality is concerned with syntactic structures. The expression of arguments in sentences determine the acceptability of utterances. Pustejovsky provides the following examples that illustrate this phenomena:

- 48. (a) ? Mary kicked me with her foot.
(b) Mary kicked me with her left foot.
- 49 (a) ?The house was built.
(b) The house was built by accomplished builders.

The examples in sentences (48a) and (49a) cannot be regarded as ungrammatical but they are semantically less acceptable than the sentences (48b) and (49b) respectively. Pustejovsky (1996:42) is of the opinion that although the corpus can be used for data mining and a general notion of empirical verifiability for patterns and cooccurrences, it cannot be used as the only source of semanticity judgments.

According to Pustejovsky, the short-comings of SELs have an effect on the structure of a semantic theory in a number of ways. Pustejovsky (1996:36) argues that current semantic theory requires words to behave as either active functors or passive arguments. He outlines three basic arguments showing the inadequacies of SELs for the semantic description of language.

- (i) The creative use of word senses: Words assume new senses in novel contexts.
- (ii) The permeability of word senses: Word senses are not atomic definitions but overlap and make reference to other senses of the word.
- (iii) The expression of multiple syntactic forms: A single word sense can have multiple syntactic realization.

3.3.1 The creative use of words

Pustejovsky (1996) employs the creative use of words in order to demonstrate that SEL model is unable to account for the data being investigated. The other contentious aspect is that the SEL model accounts for the data without making any predictions as to whether a particular datum should be possible or not. In order to demonstrate these short-comings, Pustejovsky (1996 :43) considers the ambiguity of adjectives such as **good**. The following examples in (50) illustrate this phenomena:

50. (a) Simon bought a good car.
 (b) Simon ate a good meal.
 (c) Simon fought a good fight.

Pustejovsky (1996) further suggests that within a SEL the distinct senses for an adjective such as **good** can be represented by the listing of senses in this manner: $good_1, good_2 \dots good_n$ corresponding to the three fixed senses listed below:

- good (1) to function well;
- good (2) tasty;
- good (3) to perform some act well.

Pustejovsky (1996) explains that the SEL model must account for each new sense derived in the natural language and enter it in the dictionary, thus, creating a new entry in the dictionary. The number of senses of **good** created in the natural language will be congruent to the number of distinct types the adjective **good** is able to derive. The SEL model cannot enumerate all the different senses displayed by these creative words.

- **Permeability of word senses**

The second failing of SELs relates to the fact that word senses are not atomic definitions but overlap and make reference to other senses of the word, according to Pustejovsky. The systematic ambiguity of verbs like **bake**, require a distinction with respect to change-of-state versus creation readings. Pustejovsky provides the following examples to illustrate the problem such lexical items create with regard to the overlap of meaning in such sentences:

51. (a) Buddy baked the potatoes (change –of-state)
 (b) Dira baked a cake (creation)
52. (a) Maureen cooked a meal.
 (b) Mavis cooked the carrots.

Pustejovsky (1996:47) is of the view that the problem in sentences (51) – (52) is that there is too much overlap in the “core” semantic components of the different readings. It is not possible to guarantee correct word sense selection on the basis of selectional restrictions alone. Pustejovsky (1996) further states that this approach lacks any appropriate or natural level of abstraction. The partial overlap of core and peripheral components of different meanings are responsible for creating uncertainties in the SEL model as it cannot list such ambiguities on the lexical entry in current dictionaries.

Pustejovsky points out that the inability of the SEL model to characterize all the possible meanings of the lexical item also involves adjectives which have complementary senses. These polysemous adjectives have the ability to change type. The following examples illustrate this aspect :

53. (a) Janet is beautiful.
 (b) a beautiful₁ Janet
 (c) a beautiful₂ day / event / occasion
54. (a) Richard is afraid.
 (b) *the afraid₁ Richard.
 (c) *an afraid₂ day / event / occasion

Pustejovsky (1996:49) maintains that within standard approaches to lexical semantics these adjectives depict two separate senses, one typed as predicating of animate object, and the other predicating of intervals. This would correspond to the separate senses below:

55.
$$\left[\begin{array}{l} \text{beautiful}_1 \\ \text{CAT} = \text{adjective} \\ \text{ARG 1} = \text{animate_ind} \end{array} \right]$$

56.
$$\left[\begin{array}{l} \text{beautiful}_2 \\ \text{CAT} = \text{adjective} \\ \text{ARG 1} = \text{interval} \end{array} \right]$$

Pustejovsky (1996) further explains that the above solution can be attributed to the fact that “a beautiful day” is interpreted relative to a human judging the event of that interval as beautiful in a causative relation. The difference in these adjectives is brought about by their relational structure. The **afraid**- adjective, being passive participle, are underlyingly relational.

- **Difference in syntactic forms**

Pustejovsky (1996:51) is of the opinion that the different interpretations of syntactic realization can be encoded as senses of the verb, with distinct lexical entries. He provides the following examples which illustrate the syntactic forms of the verb complement:

57. David forgot to open the gate in the morning. (factive)
 58. The driver left, forgot his keys, and sent a person to pick them up.
 (ellipsed non-factive)

59. After the passengers boarded the bus, the driver inquired about those passengers who forgot to pay. (concealed question)
60. Eric will never forget who caused the accident. (embedded question)

The above syntactic forms of the verb complement will correspond to separate senses under the SEL model, where appropriate features have been illustrated to differentiate the readings.

Pustejovsky (1996) draws a parallel between the inadequacies of finite state descriptions within the realm of the syntactic framework in the 1950s, and the inherent inability of the lexical semantic systems to capture all sense relations in natural language. Pustejovsky (1996:56) outlines that the standard theory of lexical ambiguity can be characterized as a monomorphic language of types, with the following properties:

- (i) **Monomorphic Languages:** A language where lexical items and complex phrases are provided in a single type and denotation. Lexical ambiguity is treated by multiple listing of words, both for contrastive ambiguity and logical polysemy.
- (ii) **Unrestricted Polymorphic Languages:** No restriction on the type that a lexical item may assume. No operational distinction between sub-classes of polymorphic transformations.
- (iii) **Weakly Polymorphic Languages:** All lexical items are semantically active, and have a richer typed semantic representation than conventionally assumed; semantic operations of lexically-determined typed changing (e.g., type coercion) operate under well-defined constraints.

3.3.2 Generative lexical models

Pustejovsky (1996:58) distinguishes between two distinct approaches to the study of word meaning:

- (i) a primitive-based theory which assumes that word meaning can be exhaustively defined in terms of a fixed set of primitive elements and,

- (ii) a relation-based theories which claims that there is no need for decomposition into primitives if words are associated through a network of explicitly defined links. This view relies on logical rules of inference to determine the connectedness between lexical meanings and propositions.

Pustejovsky (1996) proposes a new paradigm, the Generative Lexicon, of viewing decomposition, looking at the generative or compositional aspects of lexical semantics, rather than decomposition into specified number of primitives. He contends that the generative lexicon is characterized as a system involving four levels of semantic representations.

- (i) Argument structure: specifies the number and type of arguments that a lexical item carries;
- (ii) Event structure: provides a definition of the event type of a lexical item and phrase, and events may have subeventual structure.
- (iii) Qualia structure: represents the different modes of predication possible with a lexical item and;
- (iv) A lexical inheritance structure: identifies how a lexical structure is related to other structures in the dictionary, however it is constructed.

According to Pustejovsky (1996:58), a set of generative devices connects these four levels of semantic representation, thus, providing for the compositional interpretation of words in context. Pustejovsky (1996) stipulates that the notion of compositionality is satisfied in two ways, as weak and strong compositionality, and advances two important parameters for characterizing semantic devices:

- (i) the degree of composition within an expression and,
- (ii) How many explicitly defined senses are necessary to accomplish a unique interpretation of the phrase.

The first parameter refers to how functionally the elements in the phrase are treated, relative to the resulting interpretation. The second parameter is concerned with the linguistic and logical tradition of multiplying senses on demand for new contexts as needed to create new senses.

- **The semantic type system (Levels of representation)**

Pustejovsky (1996:61) details the organization of lexical information within a generative lexicon in terms of the four levels of semantic mentioned above. He posits three semantic transformations which form part of the generative devices that connect the four levels of lexical semantic representation. HE asserts that these semantic transformations determine semanticity on type combinations:

- (i) TYPE COERCION: where a lexical item or phrase is coerced to a semantic interpretation by a governing item in the phrase, without change of its syntactic type.
- (ii) SELECTIVE BINDING: where a lexical item or phrase operates on the substructure of a phrase, without changing the overall type in the composition.
- (iii) CO-COMPOSITION: where multiple elements within a phrase behave as functors, generating new non-lexicalized senses for the words in composition. This also includes cases of underspecified semantic forms becoming contextually enriched, such as *manner co-composition*, *feature transcription*, and *light verb specification*.

3.3.2.1 The argument structure

Pustejovsky (1996:62) assumes that the semantics of a lexical item α can be defined as a structure, consisting of the following four components:

- (i) $\alpha = \langle A, \varepsilon, \mathcal{Q}, I \rangle$

where A is the argument structure, ε is the specification of the event type, \mathcal{Q} provides the binding of these two parameters in the qualia structure, and I is an embedding transformation, determining what information is inheritable from the global lexical structure.

Pustejovsky asserts that it is imperative to begin with the argument structure so as to get a precise analysis of the semantics of words. In recent times the theory of grammar has adopted the view that the argument structure is independent of the syntax. In lexical semantics,

Pustejovsky states that argument structure is seen as a minimal specification. The flaw of such a distinction, is that, it falls short in characterizing all the possible meanings of lexical items in the lexicon. He distinguishes four types of arguments for lexical items:

- (i) TRUE ARGUMENTS: Syntactically realized parameters of the lexical item, e.g.,

61. The student has left.

Generally, true arguments are covered by the θ – criterion, which requires arguments to be expressed as syntactic constituents. According to Pustejovsky (1996:64), verbal alternations include alternations such as the inchoative / causative alternation, between polysemous forms of a verb which result in the expression of true arguments. He provides the examples in (62) to illustrate this aspect:

62. (a) The door broke.
 (b) Moses broke the door.

- (ii) DEFAULT ARGUMENTS: Parameters which participate in the logical expressions in the qualia, but which are not necessarily expressed syntactically, e.g.,

63. The man hit the child with a stick.

Pustejovsky points out that verbal alternations between polysemous forms of a verb which result in the expression of default arguments, includes alternations such as the material / product alternation. He states that such arguments are necessary for semanticity, but, however, may not be expressed in syntax. They are optional in alternations such as the material / product alternation. Pustejovsky asserts that default arguments can be satisfied by full phrasal expressions as a prepositional phrase (PP) or as a phrase incorporated into a true argument (descriptive possessive). He provides the examples below to illustrate this point:

64. (a) Patrick built a house with bricks.
 (b) Morgan carved a dog out of wood.

- (iii) **SHADOW ARGUMENTS:** These are parameters which are semantically incorporated into the lexical item. They can be expressed only by operations of subtyping or discourse specification, e.g.,

65. The woman bought expensive shoes with money.

Pustejovsky maintains that a crucial fact of shadow arguments is that their semantic content is not expressed in syntax, they can only be expressed by operations of subtyping. Shadow arguments are expressed under specific conditions. He considers the examples in (66) to indicate this phenomena:

66. (a) Theodora made the drink with oranges.
 (b) Sidwell kicked me with his big shoe.

- (iv) **TRUE ADJUNCTS:** These are parameters which modify the logical expression, but are part of the situational interpretation, and are not tied to any particular lexical item's semantic interpretation. These include adjunct expressions of temporal or spatial modification, e.g.,

67. The girl did not arrive yesterday.
 68. The woman cooked meat for five hours.
 69. The children arrived in the morning.

Adjuncts are defined more by complementarity than in terms of specific properties of the class. Pustejovsky (1996:65) claims that this type of argument is associated with verb classes and not individual verbs. In (68) above, the verb **cook** has been modified by the temporal locative modifier **for five hours**. The modification of this verb **cook** is inherited by virtue of the verb's classification as an individuated event. Pustejovsky further states that compositional operations may create an argument or shadow an argument at a phrasal projection, by virtue of compositionality in the phrase. There are instances where a true argument is defaulted by virtue of a complement's semantics, as in the examples below in (70):

70. (a) Liesel displayed her money to criminals.

(b) Lielzel displayed a snake to criminals.

In (70a) above, the true argument expressing the GOAL argument, for the verb **display**, can be defaulted by virtue of the semantics of the complement, thus, becoming an optional argument. The phrase **display a snake** demotes the true GOAL argument, thus, giving it a default status in syntax.

Pustejovsky posits that in the generative lexicon, the arguments for a lexical item are represented as ARG_1, \dots, ARG_n , where argument type is directly encoded in the argument structure, ARGSTR, where D-ARG is a default argument, and S-ARG is a shadow argument, as is illustrated in the example in (71).

$$71. \quad \left[\begin{array}{l} \alpha \\ \\ ARGSTR = \\ \dots \end{array} \left[\begin{array}{l} ARG_1 = \dots \\ ARG_2 = \dots \\ D-ARG_1 = \dots \\ S-ARG_1 = \dots \end{array} \right] \right]$$

3.3.2.2 Extended event structure

In the generative lexicon, the event structure is one of the levels of representation and is connected with argument structure. Pustejovsky (1996:66) proposes that the event variable for a verb within an event based semantics is listed as a single argument along with the logical parameter defined by a particular predicate or relation. The event structure is represented as a listing of event variable, similar to the listing of arguments, as is shown below:

$$\begin{array}{l} [ARGSTR = ARG_1, ARG_2, \dots, ARG_n] \\ [EVENSTR = EVENT_1, EVENT_2, \dots, EVENT_n] \end{array}$$

According to Busa (1996:41), the view on event structure, in the generative lexicon, is that events can be classified into three broad classes: PROCESS, STATES and TRANSITIONS. In turn, transitions are further distinguished into accomplishments and achievements. Pustejovsky

(1996:71) further states that an event tree structure needs to represent two facets for a lexical structure: the specific events and their types: He considers the schematic representation in (72) to show this aspect:

$$72. \left[\begin{array}{l} \alpha \\ \text{EVENTSTR} = \left[\begin{array}{l} E_1 = \dots \\ E_2 = \dots \\ \text{RESTR} = \dots \end{array} \right] \\ \dots \end{array} \right]$$

In a history of events in linguistic theory, Pustejovsky (2000: 11), introduces a tree structure to represent the temporal ordering and dominance constraints on an event and its subevents, as is shown in (73):

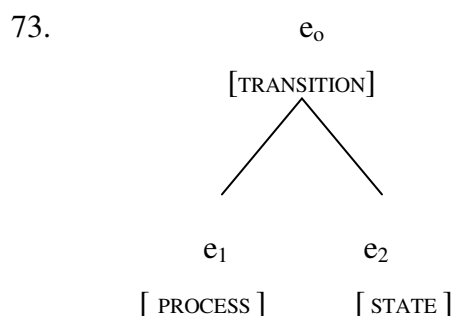

For example, a predicate such as **build** is associated with a complex event such as that shown in (73) above. The verb **build** is typically analyzed as involving a development process and a resulting state (Dowty, 1979, Moens and Steedman, 1988, and Pustejovsky, 1991b). This is represented schematically as in (74) below:

$$74. \left[\begin{array}{l} \text{build} \\ \text{EVENTSTR} = \left[\begin{array}{l} E_1 = \text{process} \\ E_2 = \text{state} \\ \text{RESTR} = <_{\alpha} \end{array} \right] \\ \dots \end{array} \right]$$

The verb **accompany** permits either telic events, TRANSITIONS, or PROCESS, unlike the verb **build**, which restricts the types of its two subevents to PROCESS and STATE. This is illustrated schematically in (75).

$$75. \quad \left[\begin{array}{l} \text{accompany} \\ \\ \text{EVENTSTR} = \left[\begin{array}{l} E_1 = T_i \\ E_2 = T_i \\ \text{RESTR} = o_\alpha \end{array} \right] \\ \\ \dots \end{array} \right]$$

Pustejovsky (1996: 72) states that the structural information for event structure is not sufficient to capture lexical distinctions that languages make, with respect to the relative prominence or importance of the subevents of a larger event, and, hence, event headedness becomes important. In generative lexicon event headedness provides a way of indicating a type of foregrounding and backgrounding of event arguments.

Pustejovsky (1996) defines the head as the most prominent subevent in the event structure of a predicate, which contributes to the focus of the interpretation. Pustejovsky further mentions that headedness is a property of all event sorts, but it distinguishes the set of transitions, specifying that part of the matrix event that is being focused by the lexical item in question. He considers that the headedness to the event structure can be represented as follows:

$$76. \quad \left[\begin{array}{l} \alpha \\ \\ \text{EVENTSTR} = E_2 = \left[\begin{array}{l} E_1 = \dots \\ \dots \\ \text{RESTR} = \dots \\ \text{HEAD} = E_1 \end{array} \right] \\ \\ \dots \end{array} \right]$$

Pustejovsky (1996) further claims that semantic underspecification figures prominently in the analysis of verbal polysemy, and that polysemy occurs when a lexical expression is unspecified with respect to headedness.

Pustejovsky (1996: 73) posits that the qualia structure is the level of representation where arguments and events are tied together within different relations which explain or elucidate

the meaning of a lexical item. In the generative lexicon, the Qualia Structure specifies four essential aspects of a word's meaning (or qualia):

- (i) CONSTITUTIVE: the relation between an object and its constituent parts;
- (ii) FORMAL: that distinguishes it within a larger domain;
- (iii) TELIC: its purpose and function;
- (iv) AGENTIVE: factors involved in its origin or "bringing it about".

Pustejovsky (1996: 76) explores two general issues concerning qualia roles:

- (i) Every category expresses a qualia role;
- (ii) Not all lexical items carry a value for each qualia role.

Pustejovsky (1996) further explains that the first point relates to how a generative lexicon provides a uniform semantic representation compositionally from all the elements of a phrase. The second point allows us to view qualia as applicable or specifiable relative to a particular semantic class. Pustejovsky uses the nouns **novel** and **dictionary** to demonstrate how qualia structures encode the meaning of nominals. The difference between the two nominals emanates from what we do with these objects. Both objects are books in the general sense, how we use them differs: while one reads a novel, a dictionary is for consulting. Hence, the respective qualia values encoding this functional information for novel and dictionary are [TELIC= reading] and [TELIC = consulting].

Pustejovsky further states that the structure of the text in a *novel* is characteristically a narrative or story, while a **dictionary** is by definition a listing of words. This distinction is captured by the constitutive role, expressing the internal structural differences. In the generative lexicon, the qualia structure is initially represented by a generic feature structure as is shown in (77) below:

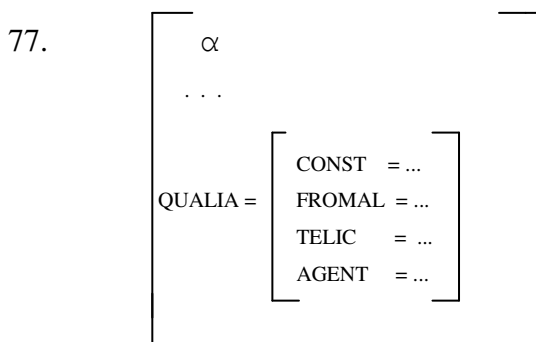

Pustejovsky (1996: 78) maintains that the above generic structure does not specify what a particular lexical item denotes and, therefore, suggests that qualia values for a lexical item have to be bounded appropriately. The generative lexicon requires that the qualia values of lexical items have to allow for interpretations that are licensed both by local syntactic and semantic context. The qualia values have to be treated as expressions with well defined types and relational structures (cf. Pustejovsky, 1991, Copestake and Briscoe, 1992). This can be shown by the arguments to the relation **read**, indicating the proper binding of the predicating term as in (78).

$$78. \left[\begin{array}{l} \text{novel} \\ \dots \\ \text{QUALIA} = \left[\begin{array}{l} \text{FORMAL} = \text{book}(x) \\ \text{TELIC} = \text{read}(y, x) \end{array} \right] \end{array} \right]$$

According to Pustejovsky (1996: 80), the qualia structure associated with causative predicates (i.e., TRANSITIONS) are analyzed as involving an initial act or process followed by a resulting state. The two phases are the AGENTIVE and FORMAL qualia roles. He considers the verb **break** in (79):

$$79. \left[\begin{array}{l} \text{break} \\ \text{EVENTSTR} = \left[\begin{array}{l} E_1 = e_1 : \text{process} \\ E_2 = e_2 : \text{state} \\ \text{RESTR} = \langle \alpha \end{array} \right] \\ \text{QUALIA} = \left[\begin{array}{l} \text{FORMAL} = \text{broken}(e_2, y) \\ \text{TELIC} = \text{break_act}(e_1, x, y) \\ \dots \end{array} \right] \end{array} \right]$$

Pustejovsky (1996) refers to Talmy's (1975, 1985) distinction of active and passive classes of processes, where the former includes verbs of motion such as **run** and **move** while the latter includes verbs such as **sleep** and **snore**. He provides that the qualia structure for the active process class can be illustrated in (80) with the verb **run** while the passive process verb **sleep** has the structure in (81):

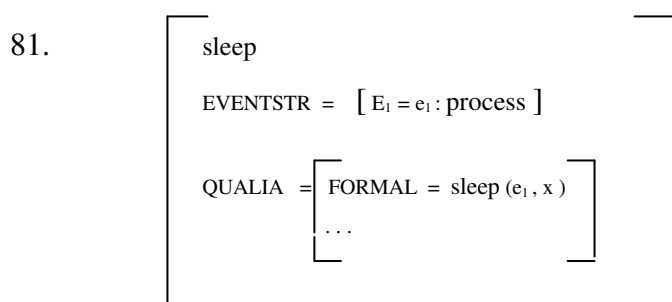
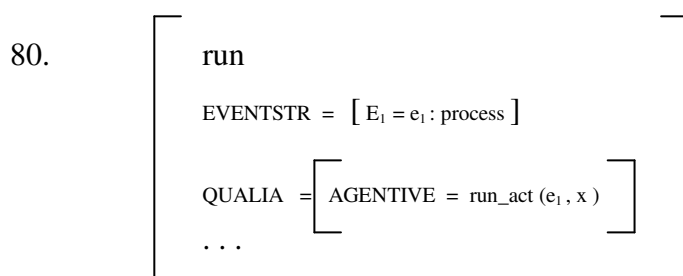

- **The interaction of semantic levels**

Pustejovsky asserts that the three levels of argument, event and qualia structure are intergrated to construct a uniform language for lexical semantic representations. Pustejovsky (1996: 82) utilises the transitive verb **build**, which is associated with two TRUE ARGUMENTS and one DEFAULT ARGUMENT to provide an intergrated representation. In the generative lexicon, the verb **build**, as a lexical accomplishment, is analyzed as containing two subevents, a process and a resulting state, as can be illustrated in (82).

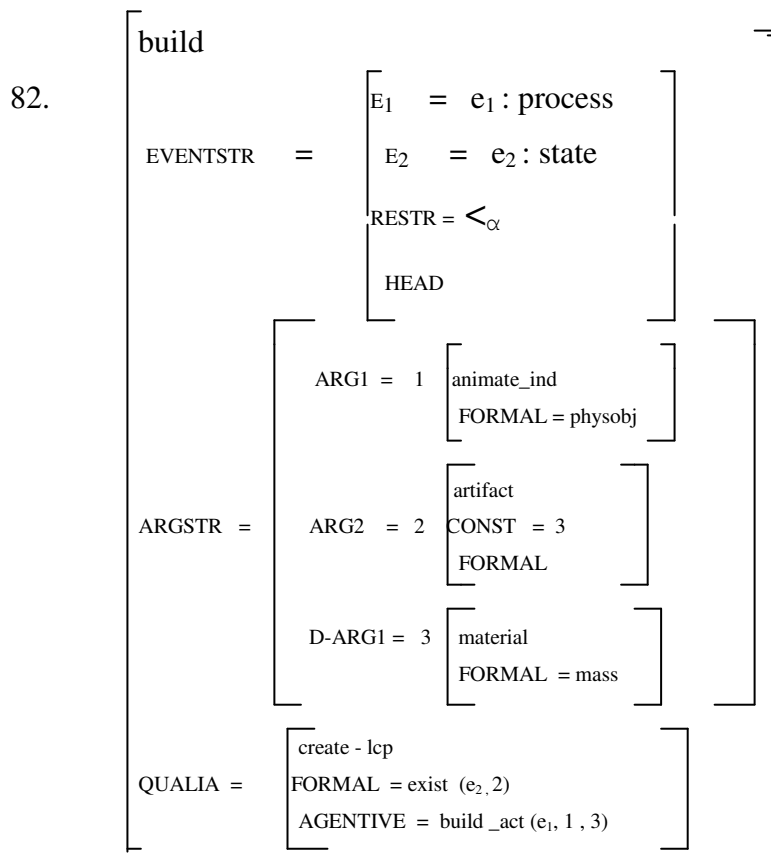

In (82) above the process is the AGENTIVE act containing the deep syntactic subject, ARG1, and the default argument, D-ARG1, which is related to the logical object by the CONSTITUTIVE relation of ARG-2. The FORMAL role expresses the resulting state specified by the object ARG2.

- **The syntax of the Qualia Structure**

Pustejovsky (1996: 85) explores in greater detail the syntax of qualia structure and, investigates the four basic roles that constitute the qualia structure for a lexical item:

- (i) CONSTITUTIVE: the relation between an object and its constituents, or proper parts.
 - (a) Material
 - (b) Weight
 - (c) Parts and component elements
- (ii) FORMAL: That which distinguishes the object within a larger domain.
 - (a) Orientation

- (b) Magnitude
 - (c) Shape
 - (d) Dimensionality
 - (e) Color
 - (f) Position
- (iii) AGENTIVE: Factors involved in the origin or 'bringing about' of an object.
- (a) Creator
 - (b) Artifact
 - (c) Natural Kind
 - (d) Causal Chain
- (iv) TELIC: Purpose and function of the object.
- (a) Purpose that an agent has in performing an act.
 - (b) Built-in function or aim which specifies certain activities

The argument here centres around the different ways of approaching the definition of a word. The qualia structure specifies the semantic constraints by which a word is understood when embedded within the language. According to Pustejovsky (1996: 86) definition and word meaning need not have anything to do with grammaticalization or grammatical behavior. Many semantic models assume that words have simple denotations and the methods of composition are borrowed from general logical inference mechanisms.

The view within the generative lexicon is that, the qualia provides the structural template over which semantic transformations may apply to alter the denotation of a lexical item or phrase. Type coercion, selective binding, and co-composition are the generative devices which formally map the expression to a new meaning. The conditioning of these operations by the syntactic and semantic environment within which a phrase appears is done by virtue of lexical governance relations. Pustejovsky explains how the NPs in subject and complement position contribute towards specifying the interpretation of the verb **use** in the sentences (83) and (84) below:

83. (a) David used all the hot water to wash the dishes.
 (b) The snake uses muscles to move.
84. (a) The salt is used in food.
 (b) the oil used in cars.

Pustejovsky explains the factors that determine the appropriateness of a sense are twofold: (i) the qualia structures for each phrase in the construction and; (ii) a richer mode of composition, which is able to take advantage of the qualia information. The qualia structure tends to specify interpretation in context as is shown by the verb **enjoy** in (85) below:

85. (a) Manuel enjoyed the news last night. (listening)
 (b) Christopher enjoyed his afternoon coke. (drinking)
 86. Ophra enjoyed A.C. Jordan's novel. (reading)

In the above examples in (85) – (86) the TELIC roles for **news**, **coke**, and **novel** project the activities of *listening to the news*, *drinking his coke*, and *reading A.C. Jordan's novel*, respectively, to the interpretation of the VP. Pustejovsky (1996: 88) suggests that the contextualization of a sense for a verb need not come from the semantics of the complement but may be influenced by the subject as well. He provides the examples in (87) to illustrate this aspect:

87. (a) Most pilots prefer J.F. Kennedy to New York.
 (b) Most pilots prefer Heathrow to Las Vegas.

In (135) above there are two factors contributing to the interpretation of the ellipsed predicate; the qualia structures associated with the subject NP, pilot, and the double object NPs, airport names, J.F. Kennedy and New York; and Heathrow and Las Vegas. Thus, the TELIC roles from the agentive nominals supersede any VP-internal interpretation.

3.3.3 The qualia structure of nominals

Pustejovsky explores the typing system necessary to characterize the semantics of NPs, in particular, the logically polysemous behavior of nominals. This characterization is done by introducing the analysis of a category in terms of the four levels of representation, i.e., event structure, argument structure, and qualia structure. Pustejovsky assumes a system based on typed feature structures as applied in Copestake and Briscoe, (1992), Copestake, (1993), and Pustejovsky and Boguraev, (1993). The hierarchy of how features are organized in a lattice

structure, where *nomrqs* refers to the least upper bound type for the types entity, proposition, and event, is shown in (88).

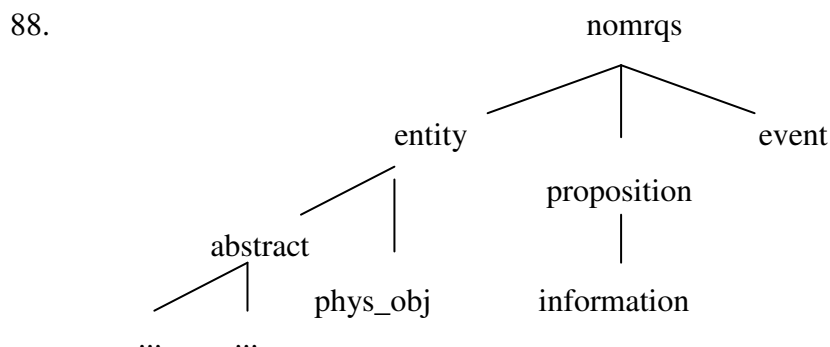

Pustejovsky and Anick (1988) explored nouns that have two senses and characterized the meaning of such ‘Double Figure-Ground’ nominals as inherently relational. They referred to the ability of a lexical item to cluster multiple senses as a Lexical Conceptual Paradigm (lcp). In Pustejovsky and Boguraev (1993) the notion of lcp is extended to project syntactic behavior from the semantics of the noun characterized as an lcp. In the generative lexicon, the lcp provides the means of characterizing a lexical item as a meta entry. Pustejovsky mentions that an lcp constructed from two base types has three senses that make reference to the entire dotted type, the process, and the result of the process. These types are, then, used to distinguish between the senses of **newspaper** and **book** as is shown in (89) below:

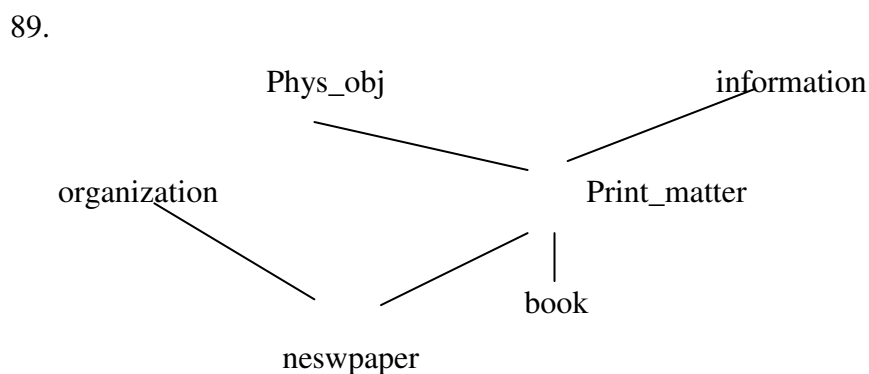

- **The interpretation of the FORMAL Quale**

In the lexicon, there are two possible structures associated with the FORMAL quale:

- (i) Simple Typing: Value of FORMAL role is identical to sortal typing of the argument;
- (ii) Complex Dotted Typing: Value of FORMAL role defines the relation between the arguments of different types.

According to Pustejovsky (1996: 95), the typing of an argument for a nominal may define the information contributed by the FORMAL Quale. The FORMAL Quale is itself the typing restriction on the argument (i.e. the one referential argument) for nouns denoting simple types. He provides the following schematic representation to illustrate the qualia structure in (90):

$$(90) \left[\begin{array}{l} \alpha \\ \text{ARGSTR} = [\text{ARG1} = X : r] \\ \text{QUALIA} = [\text{FORMAL} = X] \end{array} \right]$$

Pustejovsky states that the nouns **man** and **woman** are sorts of human, distinguished by gender, hence, this feature is represented as a CONSTITUTIVE distinction, utilizing the predicate **male**, shown in (91):

$$(91) \left[\begin{array}{l} \text{man} \\ \text{ARGSTR} = [\text{ARG1} = X : \text{human}] \\ \text{QUALIA} = \left[\begin{array}{l} \text{CONST} = \text{male}(x) \\ \text{FORMAL} = X \end{array} \right] \end{array} \right]$$

The schematic representation for complex objects denoting dotted (i.e complex) types is shown in (92).

$$(92) \left[\begin{array}{l} \alpha \\ \text{ARGSTR} = \left[\begin{array}{l} \text{ARG1} = x : T_1 \\ \text{ARG2} = x : T_2 \end{array} \right] \\ \text{QUALIA} = \left[\begin{array}{l} T_1 \ T_2 \text{ lcp} \\ \text{NORMAL} = P(y, x) \end{array} \right] \end{array} \right]$$

According to Pustejovsky (1996: 96) the schematic representation for complex objects in (92) above, must have reference to the dotted argument (x.y) in the qualia structure for this representation to be well-formed, e.g., R(e, w, x, y).

- **Interpretation of the AGENTIVE QUALE**

Pustejovsky (1996: 97) explains the interpretation of the AGENTIVE QUALE of a lexical item, in terms of Aristotle (Physics II), as the knowledge of “coming into being” of an object. A qualia structure of a simple typed (T) nominal is illustrated in the schematic representation (R) in (93) below:

$$93. \quad \left[\begin{array}{l} \alpha \\ \text{ARGSTR} = [\text{ARG 1} = \text{X} : \text{T}] \\ \text{QUALIA} = \left[\begin{array}{l} \text{FORMAL} = \text{x} \\ \text{AGENTIVE} = \text{R}(\text{e}, \text{y}, \text{X}) \end{array} \right] \end{array} \right]$$

Pustejovsky makes reference to the AGENTIVE with regard to the notion of “coming into being”, and separate a creative process of baking a cake and a process that comes about as a result of a change of state as objects such as potatoes, carrots, and other natural kinds. It is the goal of generative lexicon to associate individual qualia roles as unique values.

- **The Interpretation of the CONSTITUTIVE QUALE**

In the generative lexicon, the CONSTITUTIVE QUALE refers not only to the parts of the material of an object, but defines, for an object, what that object is logically part of, if such a relation exists. Pustejovsky provides the following illustration in (94):

$$94. \quad \left[\begin{array}{l} \text{hand} \\ \text{ARGSTR} = [\text{ARG1} = \text{x} : \text{limb}] \\ \text{QUALIA} = \left[\begin{array}{l} \text{FORMAL} = \text{P}(\text{y}, \text{x}) \\ \text{CONST} = \text{part_of}(\text{x}, \text{y} : \text{body}) \end{array} \right] \end{array} \right]$$

- **The Interpretation of the TELIC QUALE**

In the generative lexicon, the TELIC QUALE defines what the purpose or function of a concept is. Pustejovsky (1996: 99) distinguishes between two modes of TELIC:

- (i) Direct Telic: something which one acts on directly, illustrated schematically in (95).

$$95. \left[\begin{array}{l} \alpha \\ \text{ARGSTR} = [\text{ARG 1} = X : T] \\ \text{QUALIA} = \left[\begin{array}{l} \text{FORMAL} = x \\ \text{TELIC} = R(e, y, X) \end{array} \right] \end{array} \right]$$

- (ii) Purpose Telic: something which is used for facilitating a particular activity, illustrated schematically in (96).

$$96. \left[\begin{array}{l} \alpha \\ \text{ARGSTR} = [\text{ARG 1} = X : T] \\ \text{QUALIA} = \left[\begin{array}{l} \text{FORMAL} = x \\ \text{TELIC} = R(e, y, X) \end{array} \right] \end{array} \right]$$

The DIRECT TELIC is involved in the representation of nominals like **water**, where the reference to the activity of drinking incorporates a variable for the noun as object of the predicate **drink**. Pustejovsky (1996 : 100) contends that the object's purpose is the activity given in the TELIC role. He contends that the schematic representation in (97) illustrates this aspect:

$$97. \left[\begin{array}{l} \text{water} \\ \text{ARGSTR} = [\text{ARG 1} = X : \text{liquid}] \\ \text{QUALIA} = \left[\begin{array}{l} \text{FORMAL} = x \\ \text{TELIC} = \text{drink}(e, y, X) \end{array} \right] \end{array} \right]$$

The Purpose Telic is involved with objects that are used in the performance of an activity, such as with tools. The representation of **knife** illustrates this notion in (98) below:

$$98. \quad \left[\begin{array}{l} \text{knife} \\ \text{ARGSTR} = [\text{ARG 1} = X : \text{tool}] \\ \text{QUALIA} = \left[\begin{array}{l} \text{FORMAL} = x \\ \text{TELIC} = \text{cut} (e, y, X) \end{array} \right] \end{array} \right]$$

3.3.3.1 Mapping from Qualia

Mapping from Qualia entails the manner in which argument structure of lexical items are projected to syntax. Pustejovsky (1996: 101) argues that projection in generative lexicon must make reference to qualia, thereby potentially complicating the lexicon to syntax mapping. Pustejovsky further states that individual qualia compete for projection, and headedness acts as a filter to constrain the set of projectable qualia. The schematic representation for the verb **kill** in (99) illustrates this aspect:

$$99. \quad \left[\begin{array}{l} \text{kill} \\ \text{EVENTSTR} = \left[\begin{array}{l} E_1 \\ E_2 \\ \text{RESTR} = \angle_{\alpha} \\ \text{HEAD} = e_1 \end{array} \right] \\ \text{ARGSTR} = \left[\begin{array}{l} \text{ARG1} = 1 \quad \left[\begin{array}{l} \text{individual} \\ \text{FORMAL} = \text{physobj} \end{array} \right] \\ \text{ARG2} = 2 \quad \left[\begin{array}{l} \text{animate_individual} \\ \text{FORMAL} = \text{physobj} \end{array} \right] \end{array} \right] \\ \text{QUALIA} = \left[\begin{array}{l} \text{cause-lcp} \\ \text{FORMAL} = \text{dead} (e_2, 2) \\ \text{AGENTIVE} = \text{kill_act} (e_1, 1, 2) \end{array} \right] \end{array} \right]$$

Pustejovsky asserts that headedness will determine the argument associated with the second subevent, e_2 , cannot be expressed, since the qualia for the headed event expressed the template associated with that relation, as illustrated in (100):

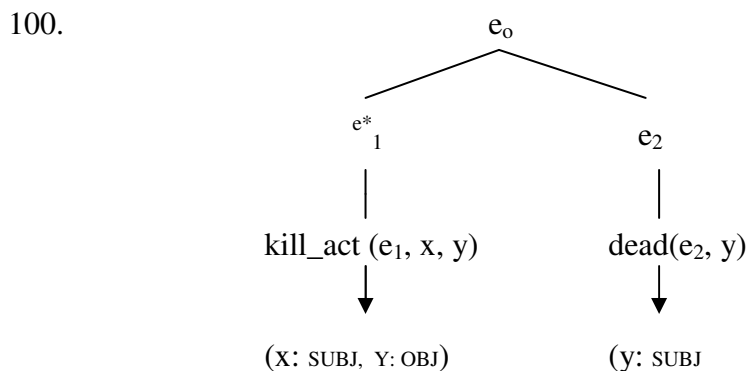

Pustejovsky (1996: 103) states that for an unergative verb such as **run**, the projection to subject follows from the qualia structure, shown in (101).

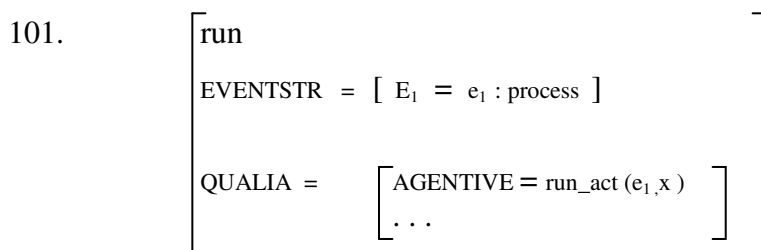

The generative lexicon specifies that the qualia of a lexical item must be saturated by syntax, and explain qualia saturation in the following manner:

- (A) **QUALIA SATURATION** : A qualia structure is saturated only if all the arguments in the qualia are *covered*.
- (B) **COVERING**: An argument x is covered only if:
- (i) x is linked to a position in s-structure; or
 - (ii) x is logically dependent on a covered argument y ; or
 - (iii) x is existentially closed by virtue of its type.

3.4 THE SEMANTICS OF NOMINALS

This section focuses on how a generative lexical theory can contribute towards a classification of the different nominal types. Pustejovsky (1996: 141) is of the view that the semantics of nominals can distinguish four major areas of concern from the perspective of a lexical semantic theory:

- (i) The distinction in complement-taking behavior between nouns and verbs;
- (ii) How nominalizations and event-denoting nominals are distinguished from their corresponding verbal representations and events they denote: that is, what is the difference between an event represented as a sentence, and an event represented as an NP;
- (iii) The representation of logical polysemy in nominals, such as **window**, **record**, **book**, and how these implicitly relational nominals differ from relational nominals;
- (iv) How the semantics of nominals facilitates the richer compositional interpretation required for characterizing natural language semantics as polymorphic; that is, what allows for co-compositional interpretation in natural language.

The variations that can be used in the interpretation of nouns is given attention in this section. The three distinct dimensions used in characterizing the semantics of NPs is given below.

- (i) **ARGUMENT STRUCTURE:** How many arguments the nominal takes; what they are typed as ; whether they are simple, unified, or complex types.
- (ii) **EVENT STRUCTURE:** What events the nominal refers to, both explicitly and implicitly.
- (iii) **QUALIA STRUCTURE:** What the basic predicative force of the nominal is, and what relational information is associated with the nominal, both explicitly and implicitly.

3.4.1 Nominals with unified types

Pustejovsky (1996) emphasizes the need to use a scheme that allows for multiple inheritance as previous attempts at structuring conceptual hierarchies have not been adequate in accounting for context variation. This is illustrated in the Conventional Representation of Inheritance Relations in (102).

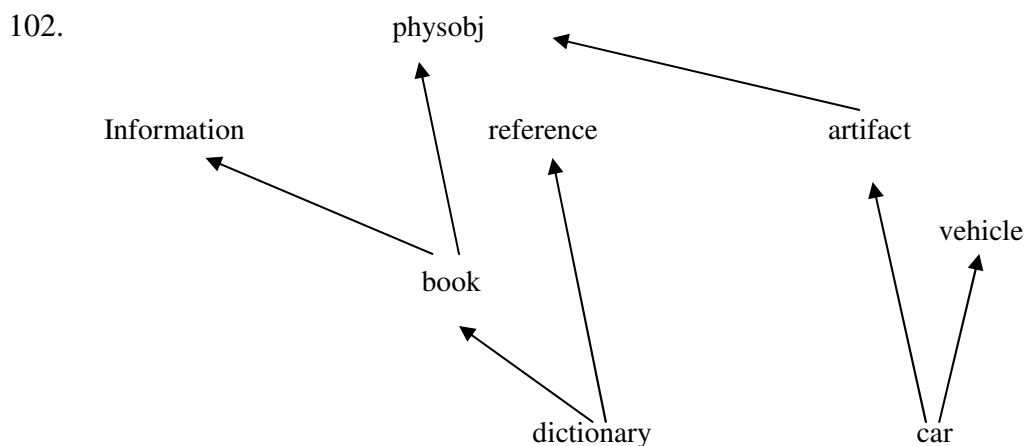

Pustejovsky points out that in the generative lexicon, models such as the one in (102), suffer from a limited notion of lexical structure, particularly, the ambiguity of class membership. According to Pustejovsky, there has been no theory to either:

- (a) explain how to assign structure to lexical items, or
- (b) specify lexical relations between lexical items in terms of links between certain aspects of their respective lexical structures.

Pustejovsky considers the structure given in (103) to illustrate the different senses between **book** and **dictionary** below.

103.

	play is_a book	dictionary is_a book
read	ok	no
buy	ok	ok
consult	no	ok
begin	ok	no

In (103) above, the inheritance system for lexical knowledge has some shortcomings by being unable to capture the different dimensions of meaning for lexical items. **Book** and **dictionary** behave differently in terms of how they are selected by different relations. Pustejovsky maintains that a single lattice for inheritance is inadequate for capturing the different dimensions of meaning for lexical items. It is on this basis that Pustejovsky and Boguraev (1993) proposed for the need for typed inheritance for lexical information in regards to the structure of Lexical Inheritance Theory. The inheritance through qualia for **book** and **dictionary** is thus represented in (104) below.

104. (a) book is_formal phys-obj
 (b) book is_telic information
 (c) book is_agent information
 (d) dictionary is_formal book
 (e) dictionary is_telic reference
 (f) dictionary is_agent compiled-material
 (g) play is_agent literature
 (h) play is_telic book

Pustejovsky proposes that the different inheritance structures in (104) can be illustrated by the diagram in (105) below.

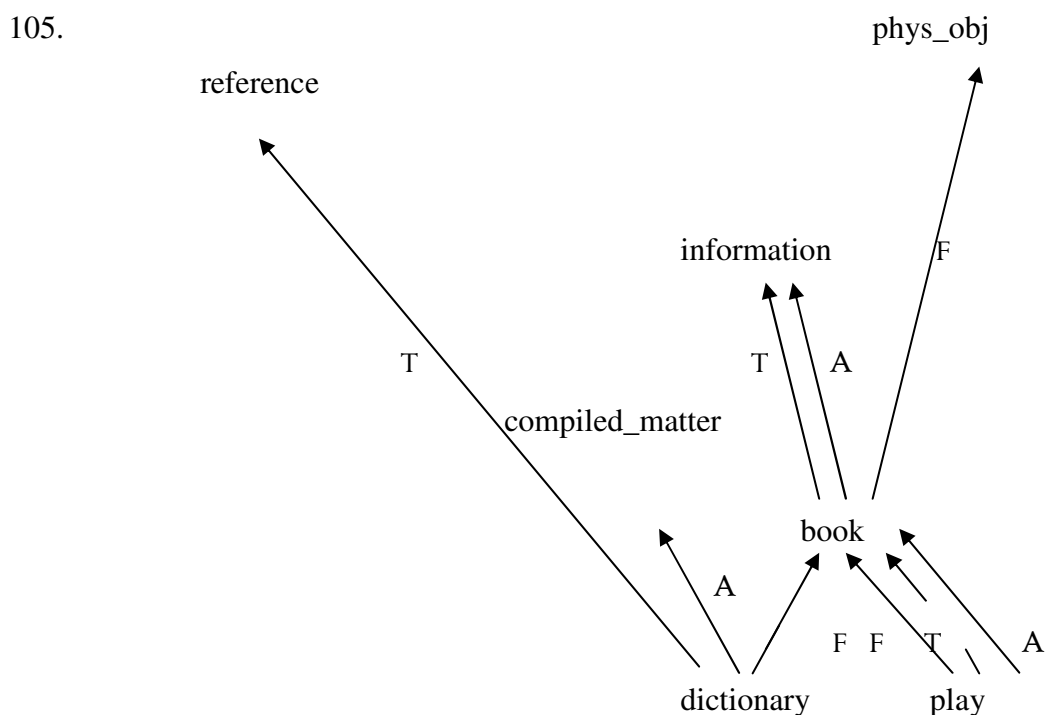

In the generative lexicon paradigm, the qualia roles differentiate the pattern structures resulting in a *typed inheritance*. In Pustejovsky (1991) and Pustejovsky and Boguraev(1993), a distinction is made between fixed and projective inheritance. Pustejovsky (1996: 255) defines inheritance in the following manner:

A sequence $\langle Q_1, P_1, \dots, P_n \rangle$ is an inheritance path, which can be read as the conjunction of ordered pairs $\{ \langle x_i, y_i \rangle \mid 1 \leq i \leq n \}$

The generative lexicon specifies that inheritance arises as result of constraints on functional information about the object supplied by the qualia. Pustejovsky (1996: 146) suggests that different qualia may unify to form a unified type, if the qualia unification is well-formed. He considers the following example of unified types represented by the nominal **food** in (106).

$$106. \left[\begin{array}{l} \text{food} \\ \text{ARGSTR} = [\text{ARG1} = x : \text{physobj}] \\ \text{QUALIA} = \left[\begin{array}{l} \text{FORMAL} = x \\ \text{TELIC} = \text{eat} (e^p, y, x) \end{array} \right] \end{array} \right]$$

In (106) **food** emanates from a qualia based constraint on the type *physobj* that it be edible. The TELIC role specifies only the activity of eating. Pustejovsky considers the example in (107) where the object is illustrated as an artifact.

$$107. \left[\begin{array}{l} \text{artifact} \\ \text{ARGSTR} = \left[\begin{array}{l} \text{ARG1} = x : \text{top} \\ \text{D-ARG1} = y : \text{human} \end{array} \right] \\ \text{QUALIA} = \left[\begin{array}{l} \text{FORMAL} = x \\ \text{TELIC} = \text{make} (e^T, y, x) \end{array} \right] \end{array} \right]$$

In (107) above, the artifact specifies very little concerning its nature as an object, the only information relates to the AGENTIVE value as there is an underspecification of the FORMAL quale, and that the artifact is human derived. The non specific nature of the description of the

of the artifact implies that it could be a social construct, a verbal act or a physical object. Pustejovsky (1996: 147) suggests that an artifact can further restrict the type which participates in the qualia relation, thereby unifying a subtype with the qualia structure for the concept artifact. In the generative lexicon the FORMAL value of a phys(ical) obj(ect) and the AGENTIVE value of an artifact are combined as in (108).

$$108. \left[\begin{array}{l} \text{phys_artifact} \\ \\ \text{ARGSTR} = \left[\begin{array}{l} \text{ARG1} = x : \text{physobj} \\ \text{D-ARG 1} = y : \text{human} \end{array} \right] \\ \\ \text{QUALIA} = \left[\begin{array}{l} \text{FORMAL} = x \\ \text{TELIC} = \text{make} (e^T, y, x) \end{array} \right] \end{array} \right]$$

The resulting lexical representation in (108) indicates the argument and qualia relations as a unified type. Pustejovsky and Boguraev (1993) suggest that unified types implement the principle of orthogonal inheritance which allows a lexical item to fall into multiple classes along different dimensions of meaning, and that each dimension is specified in terms of qualia roles (c.f., Busa, Lenci, Calzolari and Pustejovsky, 1999).

Pustejovsky (1996) discusses the unification of qualia structures to form a unified type extends to tools and artifacts as well. He considers the example in (109) where a **tool** has a TELIC value indicating only a purpose telic as is shown below.

$$109. \left[\begin{array}{l} \alpha \\ \\ \text{ARGSTR} = [\text{ARG 1} = x : \text{top}] \\ \\ \text{QUALIA} = \left[\begin{array}{l} \text{FORMAL} = x \\ \text{TELIC} = R (e, x, y) \end{array} \right] \end{array} \right]$$

Pustejovsky states that in (109) above, α specifies very little concerning its nature as an object, the only information relates to the TELIC value, and the classification of α as an entity

that has use, without mentioning anything in regard to its AGENTIVE value. The qualia structures combine to form a unified type, *artifact_tool*, which is represented as in (110a) and (110b).

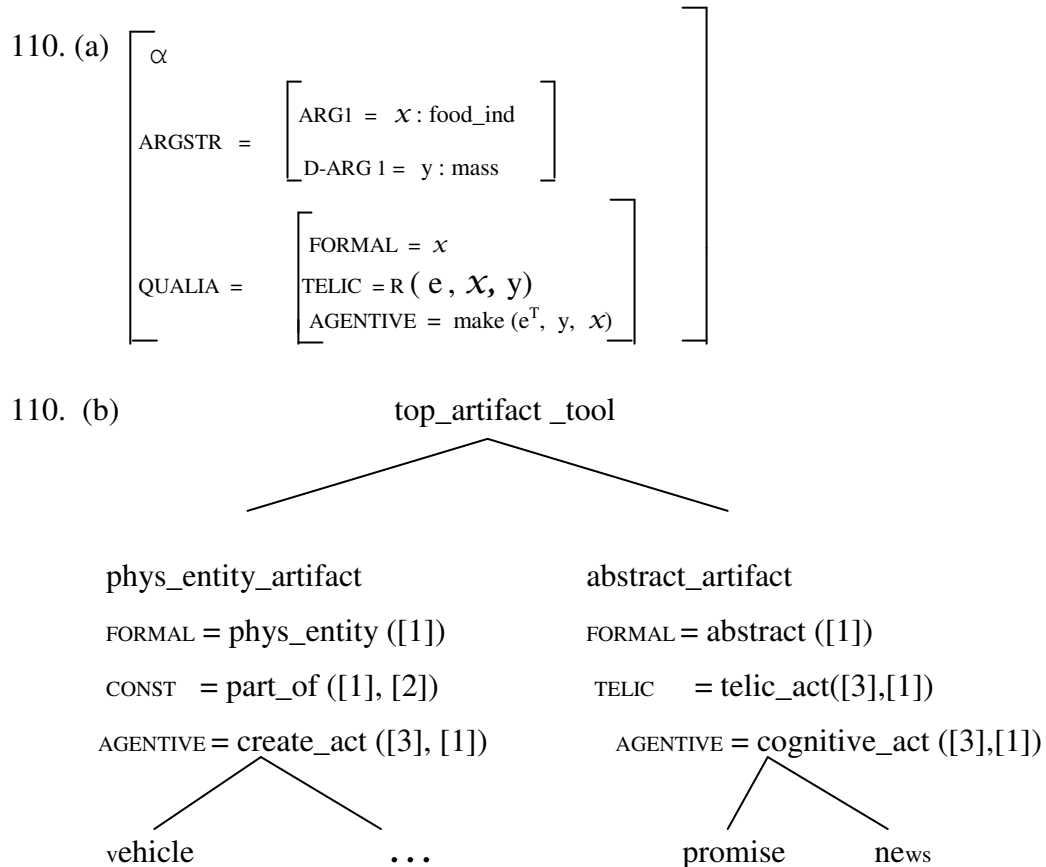

Type unification can be illustrated by nouns such as **scissor** as in (111).

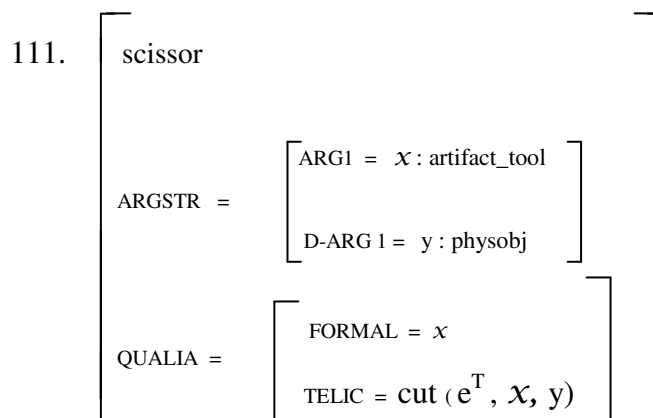

The process of type unification can be illustrated in (112), where unlabelled edges denote the FORMAL quale as is shown below.

112.

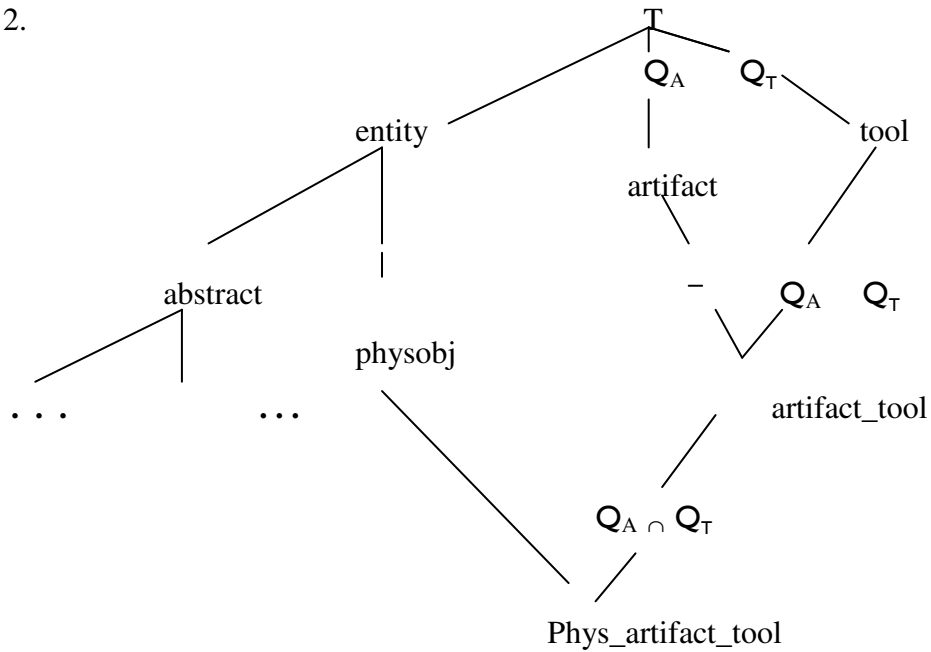

3.4.2 Nominals with Complex Types

Complex types involve more than one element, that is, they are a combination of the elements of the set of simple types and elements of the unified types (c.f., Busa, Lenci, Calzolari and Pustejovsky, 1999). Complex types can be illustrated in (113) below.

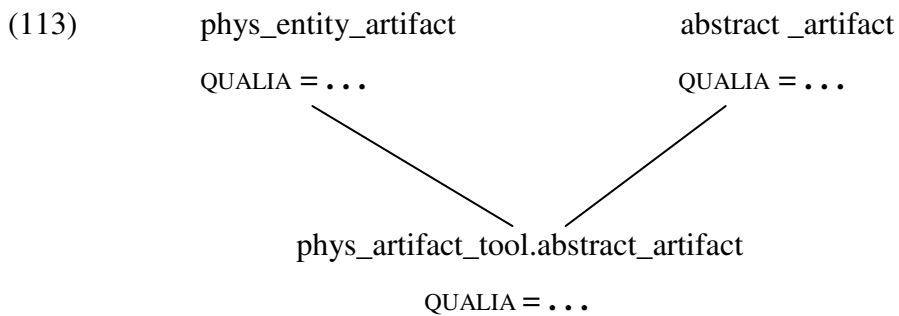

As complex types are useful in specifying different polysemies associated with nominals, Pustejovsky (1996), distinguishes different classes of polysemies for semantically related lexical items. Pustejovsky (1996: 150) assumes that **book** is a species of “printed material,” associated with type `print_matter` and provides the lexical conceptual paradigm (lcp) for this dot (i.e. complex) object as is given in (114) below.

114. `print_matter_lcp = {physobj.info, physobj, info}`

In the generative lexicon, the nominal **newspaper** refers logically to the organization which publishes, while the noun **book** does not have such a sense. The noun **book** has only two senses, one relating to information and the other sense relating to the physical object:

- 115 (a) *The newspaper* filled a sub editor vacancy
 (b) *The newspaper* is taking the matter to court.
116. (a) *The book has declined to answer.
 (b) *The author is taking the book to court.

Pustejovsky (1996: 154) maintains that while the noun **newspaper** carries a sense corresponding to the organization which publishes it, the noun **book** is unable to denote the publisher of the book in these contexts. The complex type **newspaper** has the lcp illustrated in (192) below.

117. newspaper_lcp = {print-matter.organization, print-matter, organization}

The lattice structure relating the type associated with nominals **book** and **newspaper** with regard to print-matter is shown in (118).

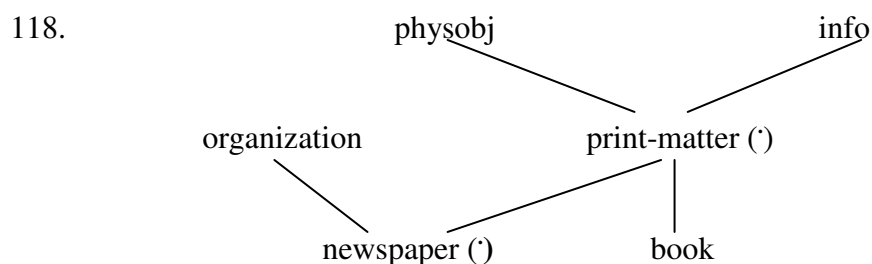

The generative lexicon specifies that the qualia structure for **newspaper** is a specialization of the lcp known as product-producer, where the AGENTIVE quale makes reference to the dot element denoting the producer and the FORMAL quale refers to the product. The absence of the dot (complex) object is conspicuous, as it is noticeable as the only exception, particularly, when the dot object has to define itself, as is illustrated in the lexical structure of the noun **newspaper** in (119).

$$119. \left[\begin{array}{l} \text{newspaper} \\ \text{ARGSTR} = \left[\begin{array}{l} \text{ARG1} = x : \text{information} \\ \text{ARG2} = y : \text{info phys_obj} \end{array} \right] \\ \text{QUALIA} = \left[\begin{array}{l} \text{org 'Info' phys_obj_lcp} \\ \text{FORMAL} = y \\ \text{TELIC} = \text{read} (e_2, w, , y) \\ \text{AGENTIVE} = \text{publish} (e_1, , x, y) \end{array} \right] \end{array} \right]$$

In the generative lexicon a distinction is also made between the nominals **book** and **novel**. A **book** may refer to **novel** in many contexts, but **novel** is more informative and less extensive in its distribution. Pustejovsky (1996: 156) specifies that the nominals **book_** and **novel** are dot (complex) objects but the **novel** is the subtype of the dot object **book_**. A **book** is regarded as an information holder of any type, whereas, the **novel** is restricted in its type of information as it is a narrative. Pustejovsky further maintains that a **book** denotes type $\text{physobj} \cdot \text{info}$, the dot object associated with **novel** is $\text{phys(ical) obj(ect) narrative}$, where $\text{narrative} \leq \text{info}$. Pustejovsky illustrates this aspect in the example in (120).

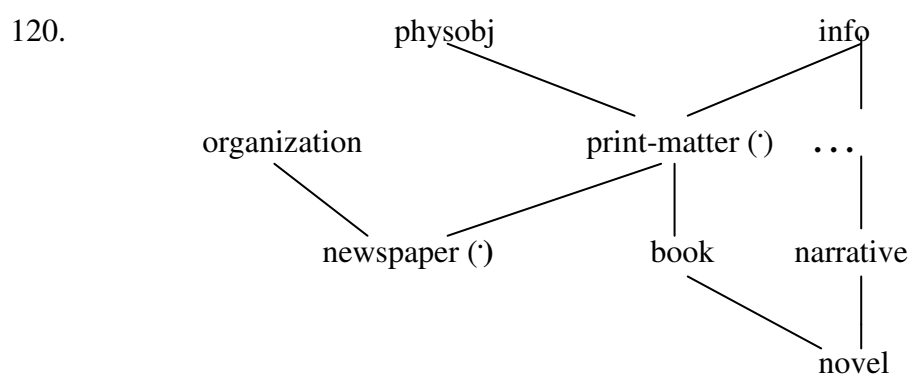

Pustejovsky states that the complex types are useful in explaining the polysemy associated with process-result nominalizations, such as **examination**. He considers the lexical structure for the noun **examination** denoting a dot (complex) object with process and dot elements in (121).

$$\begin{array}{l}
 121. \quad \left[\begin{array}{l}
 \text{examination} \\
 \text{EVENTSTR} = \left[\begin{array}{l}
 E_1 = \text{process} \\
 E_2 = \text{state} \\
 \text{RESTR} = <\infty
 \end{array} \right] \\
 \\
 \left[\begin{array}{l}
 \text{ARG1} = 1 \left[\begin{array}{l}
 \text{animate_ind} \\
 \text{FORMAL} = \text{physobj}
 \end{array} \right] \\
 \text{ARG2} = 2 \left[\begin{array}{l}
 \text{physobj} \\
 \text{FORMAL} = \text{entity}
 \end{array} \right]
 \end{array} \right] \\
 \\
 \text{QUALIA} = \left[\begin{array}{l}
 \text{event} \cdot \text{event} \\
 \text{FORMAL} = \text{examine_result} (e_2, [1]) \\
 \text{AGENTIVE} = \text{examine_act} (e_1, [1], [2])
 \end{array} \right]
 \end{array} \right]
 \end{array}$$

Pustejovsky contends that the polysemous nature of the noun **examination** arises from the two senses that are inherent in this nominal. He considers the sentences in (122) where the two senses are illustrated below.

- 122 (a) The examination was postponed until next week.
 (b) Wendy did not understand Section B of the examination.

In sentence (122a) the noun **examination** refers to the event of the examining, whereas, in sentence (122b) emphasis is on the questions in Section B that compose the event of the examination. Pustejovsky (1998: 63) maintains that the range of complex types in natural language is quite broad and rich, including the following type combinations in (123) below.

123. (a) physobj · info: e.g., “book,” “newspaper”
 (b) event · event: e.g., “examination”
 (c) event · question e.g., “examination”
 (d) org · physobj · info e.g., “newspaper”

3.4.3 Varieties of nominalization

Pustejovsky (1996) investigated the varieties of nominalization by looking at the contribution of other linguists, such as Davidson (1967) and Parsons (1981), who explored the link between nominalization and events, whose inference patterns tended to mirror the sentential structures associated with such nouns. He considered the sentences in (124) to illustrate the inference patterns.

124. (a) When fire burns, it requires oxygen.
 (b) The burning of fire requires oxygen.

According to Pustejovsky, the purpose of Davidson's approach was to make quantification over objects possible with event nominals. Higginbotham (1983, 1985), Verkuyl (1990, 1993) and Grimshaw (1990) went further by extending this notion in investigating the function of nominalization types with respect to quantification in syntax.

Pustejovsky (1996: 166) suggests that an explanation in event-denoting types will enhance the understanding of the contribution made by nominals to causal inference. He considers the sentences in (125) where the nominalized verb makes reference to the same event description as the verb.

125. (a) *The burning requires oxygen.
 (b) *Burning requires oxygen.

He provides the lexical semantic structure for the nominal **burning** in (126), showing the event description associated with.

126. burning

$$\left[\begin{array}{l} \text{ARGSTR} = \left[\text{ARG1} = x : \text{physobj} \right] \\ \text{EVENTSTR} = \left[\begin{array}{l} \text{E}_1 = e_1 : \text{process} \\ \text{HEAD} = e_1 \end{array} \right] \\ \text{QUALIA} = \left[\text{AGENTIVE} = \text{burn_act}(e_1, x) \right] \end{array} \right]$$

In (126) above, event denotation has been the focus of interpretation. Pustejovsky (1996: 167) suggests that such interpretation appears to be a property of **ing**-nominals in general, particularly, for left headed events. A view supported by Asher (1993) who claims that this is due to the aspectualizing nature of the nominalization suffix **-ing**, resulting in an interpretation similar to the progressive form in the verbal system, as is illustrated in (127) below.

127. (a) The launching of the manifesto occurred on Saturday.
 (b) The launching of the manifesto was delayed.

Pustejovsky (1996) expands Asher's perspective by comparing the **ing**-nominalizer to agentive nominals created by suffixation with the **-er** and **-or** suffixes, **baker** and **advisor**. Pustejovsky suggested an alternative view which enhances the notion that the **ing**-nominal denotes the complete event in a way identical to both simple events such as **war** and complex events such as **examination**. In (127) above, the coercing nature of the predicates seem to alter event denotation by the **ing**-nominal, thereby, resulting to an aspectualized interpretation, shifting focus to the preparatory phase of the event. In (127b) event denotation is done by the **ing**-nominal, **launching**, and the verb **delay** is the aspectualizer.

According to Pustejovsky, the alternative view though plausible, seem to fall short on two aspects:

- (i) Right-headed transitions (i.e, achievements) are much less acceptable as **ing**-nominals than are processes and left-headed transitions.
 (ii) There is no interpretation of **ing**-nominals as the result of an event, as there is with **ion**-nominalizations, such as **destruction**.

He considers the sentences in (128) – (130) where the behaviour of **arriving** and **arrival** in respect of the first aspect is illustrated.

128. (a) * The arriving of Sidwell was expected.
 (b) ?The arriving of Sidwell late was expected.
129. (a) The arrival of Sidwell was expected.
 (b) The arrival of Sidwell late was expected.

130. (a) Sidwell's arrival was dignified.
 (b) The arrival of the bus is expected at 7.30 pm.

With respect to the first aspect, right-headed transitions are expected to be anomalous when appearing as **ing**-nominals, but, sentence (128a) display the contrary. The sentences with the **ing**-nominal are grammatical on condition that some reference is made to the culminating state of event as is illustrated in (128b).

With respect to the second aspect, Pustejovsky advances the notion that the **ing**-nominals are not polysemous between process and result readings, as are most **-ion** nominalizations such as **destruction**. He illustrates this aspect in the examples shown in (131) – (132) respectively.

131. (a) *The destroying (of the forest) was pervasive.
 (b) The destruction was widespred.
132. (a) *The constructing (of the school) was well financed.
 (b) The construction was well financed.

The **ing**-nominals make reference only to the initial event, thereby, reflecting a single sense. The lexical structure of the **ing**-nominal form of **constructing** illustrates this notion in (133).

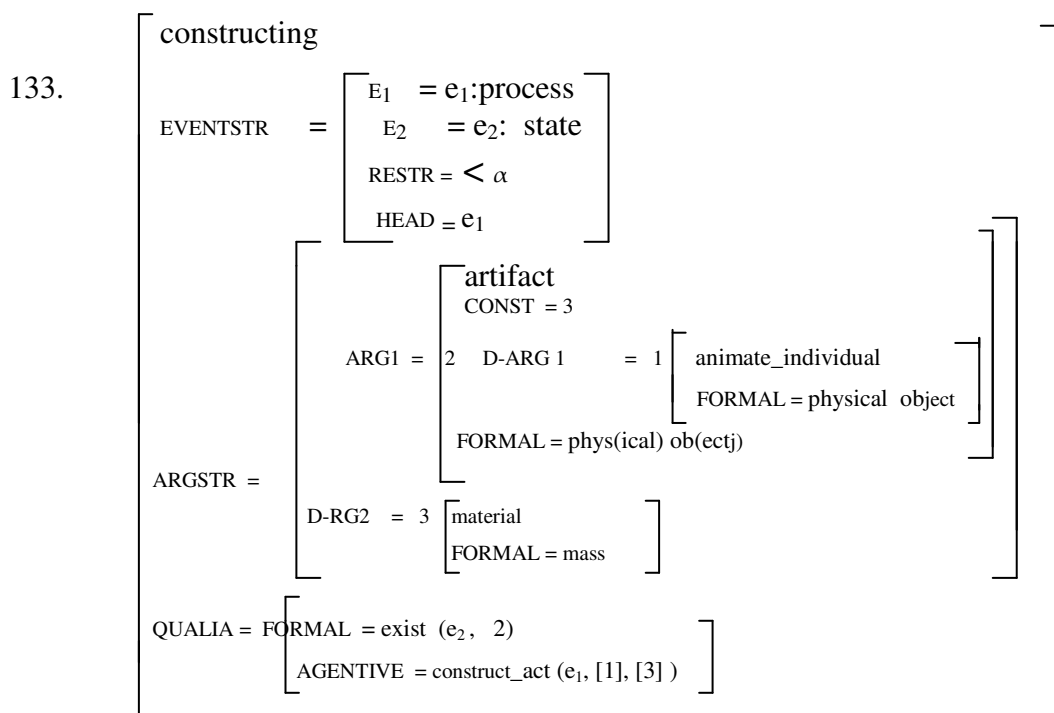

The process result nominals tend to denote dot objects which are typed as events, and these dot objects are the complex type, e_1, e_2 ; illustrated as in (134) below.

134. process ` result_lcp = {process ` result, process, result}

Pustejovsky provides the lexical representation of the noun **examination** to indicate how this type is intergrated, as is shown in (135).

135.
$$\left[\begin{array}{l} \text{examination} \\ \text{EVENTSTR} = \left[\begin{array}{l} \bar{E}_1 = \text{process} \\ E_2 = \text{state} \\ \text{RESTR} = < \infty \end{array} \right] \\ \text{ARGSTR} = \left[\begin{array}{l} \text{ARG1} = 1 \left[\begin{array}{l} \text{animate_ind} \\ \text{FORMAL} = \text{physobj} \end{array} \right] \\ \text{ARG2} = 2 \left[\begin{array}{l} \text{physobj} \\ \text{FORMAL} = \text{entity} \end{array} \right] \end{array} \right] \\ \text{QUALIA} = \left[\begin{array}{l} \text{event ` event} \\ \text{FORMAL} = \text{examine_result} (e_2, [1]) \\ \text{AGENTIVE} = \text{examine_act} (e_1, [1], [2]) \end{array} \right] \end{array} \right]$$

Pustejovsky states that the noun **examination** is a dot object composed of process and state, related by the RESTR relation in the event structure of precedence. He further elaborates that this dot object differs with other dot object only in terms of typing on the dot element. He asserts that the noun **book** is also a dot object, but, is composed of information and physobj, related by the FORMAL relation of containment.

He considers the lexical representation of the verb **develop** whose FORMAL role reference to a state and to the object, in (136).

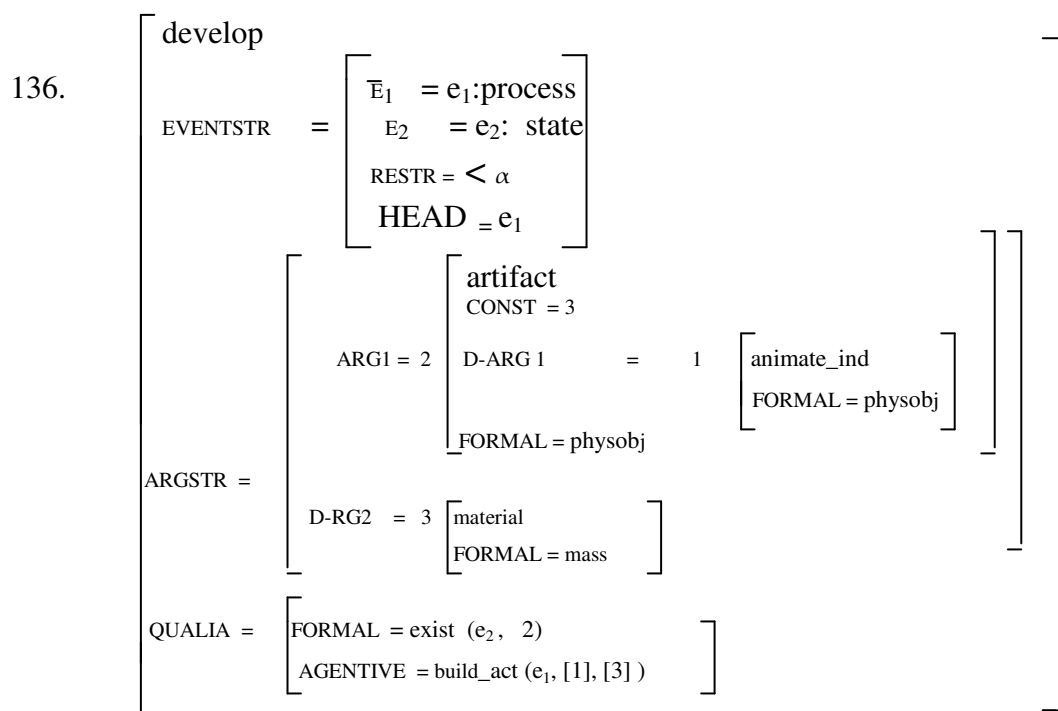

In (136) above, the affixation of the nominalizing suffix – **ment** to the verb **develop** leads to the creation of a dot object, process state, where the FORMAL quale predicates of the individual and the state.

Pustejovsky (1996: 173) cites Grimshaw (1990) and others who have argued for grammatical distinctions between **examination** and the noun **exam**. He considers the sentences below where **exam** and **examination** are illustrated in (137) – (139) below.

- 137 (a) The examination was difficult.
(b) *The examination was in the hall.
138. (a) The exam was difficult.
(b) The exam was in the hall.
139. (a) The examination of first year students.
(b) *The exam of the first year students.

Pustejovsky specifies that the nominal **exam** contains an information object and that this information object is part of the type of **exam**, along with the process of taking the exam. He

provides the lexical structure of the nominal **exam** in (140). In the generative lexicon it is specified that the fundamental difference between **exam** and **examination** is that, **exam** is an event artifact while **examination** is an event with no physical-object denotation.

$$140. \left[\begin{array}{l} \text{Exam} \\ \text{ARG} = [\text{ARG1} = \mathcal{X} : \text{question}] \\ \text{EVENTSTR} = [E_1 = e_1 : \text{process}] \\ \text{QUALIA} = \left[\begin{array}{l} \text{question} \cdot \text{process_lcp} \\ \text{FORMAL} = \text{ask}(e_1, z, \mathcal{X}) \\ \text{AGENT} = \text{make}(e_2, y, \mathcal{X}) \end{array} \right] \end{array} \right]$$

The lexical representation of **exam** in (140) illustrates the fact that **an exam** can refer to the set of questions which compose the event of the examination, or the event itself. According to Pustejovsky, there are other nominals which act in a similar manner like **exam**, nominals such as **belief**, whose lexical representation is illustrated in (141) below.

$$141. \left[\begin{array}{l} \text{belief} \\ \text{ARG} = \left[\begin{array}{l} \text{ARG1} = \mathcal{X} : \text{prop} \\ \text{D-ARG1} = y : \text{human} \end{array} \right] \\ \text{EVENTSTR} = [E_1 = e_1 : \text{state}] \\ \text{QUALIA} = \left[\begin{array}{l} \text{state} \cdot \text{prop_lcp} \\ \text{FORMAL} = \mathcal{X} \\ \text{AGENT} = \text{believe}(e_1, y, \mathcal{X}) \end{array} \right] \end{array} \right]$$

Pustejovsky states that the nominal **belief** is a dot object, which denotes the complement proposition and the state of believing something. He considers the sentences in (142) – (143) below illustrate this notion.

142. Fiona believes that Debbie is sick.

143. Fiona's belief that Debbie is sick.

He examines the semantics of factive nominalizations and claims that the NPs which carry the factive readings are not factive outside of their selectional environments. He considers the

following sentences in (144) below, where Asher (1993) claims that they are factive. He provides the corresponding sentential structures in (145).

144. (a) The collapse of the bridge is a fact.
 (b) Moffat informed Murray of Robert's departure.
 (c) The collapse of the Zimbabwean dollar is imminent.
145. (a) That the bridge has collapsed is a fact.
 (b) Moffat has informed Murray that Robert has departed.
 (c) That the Zimbabwean dollar will collapse is imminent.

Pustejovsky (1996: 176) maintains that factive interpretation in (144) above, is caused by the coercive property of factive predicates. At times these event nominals appear in other contexts without factive interpretation, as in (146) below. Pustejovsky further states that factivity is an interpretation that many NPs assume when placed within a factive coercive environment such as the complement of **inform** and as subject of **imminent**, as illustrated in (147).

146. (a) The collapse of the Euro was prevented by the European Parliament.
 (b) Joseph's departure was stopped by the traffic officer.
147. (a) Joan informed me of your headache.
 (b) Rain is a real possibility.
 (c) John informed his uncle of his Rhodes scholarship.

Pustejovsky provides the semantic selection structure below to illustrate how **inform** is a factive predicate which coerces its complement to a factive interpretation.

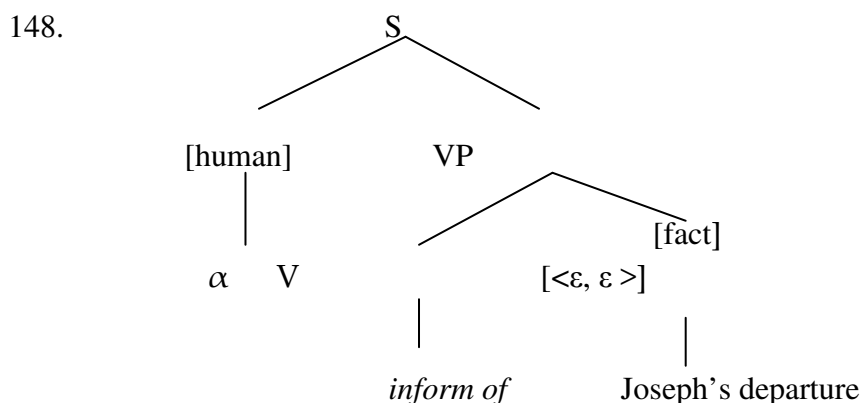

He maintains that the factive reading is coerced onto the event description in a manner similar to true complement coercion.

In summary, Pustejovsky has investigated the polysemy inherent in many nominalization processes, and juxtaposed that with other nominals that seem to be unable to behave polysemously.

- **Lexicalization and Lexical Conceptual Paradigms**

Pustejovsky explores a number of issues (i) what the consequences are for lexicalization theory given the notions of lcp and qualia structure in the semantics. (ii) The characterization of how meaning maps to lexical form; (iii) the correspondence between lexicalized semantic expressions and (iv) expressions with similar structure derived compositionally in the syntax.

Pustejovsky (1996: 178) stipulates that the type cluster associated with a lexical paradigm (lcp) allows the realization of a number of senses, but is itself a functionally defined structure. Any lcp, lcp_i , in the type system, the language may express it as a single lexical item or split it into distinct lexical forms according to Pustejovsky.

Pustejovsky regards the nominal **transaction** as a case of split lexicalization within the lcp type, as it cannot make reference to the individual type. The nominals **purchase** and **sale** are also in this split lexicalization but they do refer to the individual events, though they still require reference to the entire type cluster. Pustejovsky maintains that there is no logical polysemy associated with these nouns, in terms of the process-result ambiguity. The noun **purchase** seems to be logically polysemous between the event and the object involved in the transaction, while the noun **sale** is not, as it only denotes the event. Pustejovsky considers the sentences in (149) – (150) where this notion is illustrated.

149. (a) The Municipality prohibits the purchase of alcohol on Sundays.
 (b) The purchases I made left me penniless.
150. (a) The sale of the car this month seems likely.
 (b) *The sales I made yesterday have already been taken.

Pustejovsky provides the lexical representation for the noun **purchase** in (151) below.

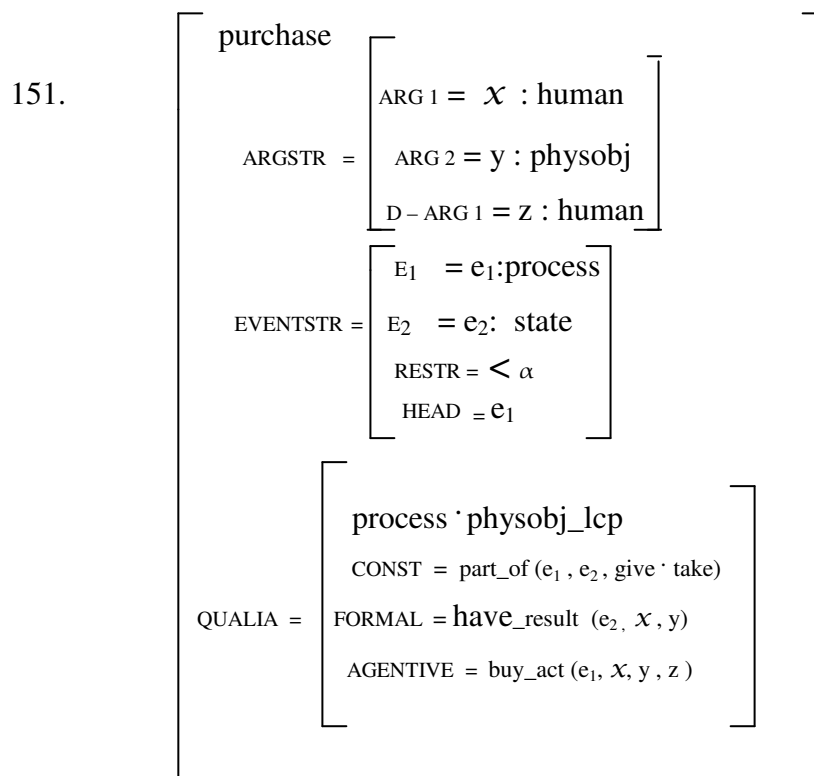

Pustejovsky mentions that though nouns such as **apple**, **lemon**, **grape** are polysemous between the product and the producer of the product sense as in (152), there are many words that have only one sense, as in (153).

152. (a) The people have planted apples in the field behind the school.
 (b) There are apples in that sack.

153. (a) The pines are growing slowly.
 (b) The people have collected pines for the wreath (*pine cones*)

Pustejovsky states that if **pine cones** were to be edible or eaten, the semantic conceptualization between the **tree** and the **cone** would change as well, possibly permitting the polysemy as a result.

3.4.3.1. The contribution of Generative Lexicon Theory (GL theory) to the study of nominalization

Busa (1996:27) outlines the importance of the Generative Lexicon Theory (GL theory) by stating that, it provides us with tools of great descriptive power for the semantics of lexical items and with the devices that allow us to make a number of important generalizations. She states that the GL theory is based on a view of the lexicon as an active set of mechanisms which exploit the internal structure of lexical items to compositionally account for meaning shifts. She points out that the GL theory argues against a view of lexical structures as an unstructured set of specifications of syntactic categories and primitive semantic features. Rather, the lexicon contains ‘pre-syntactic’ information based on the semantic type (viz. Cognitive structures), which take the form of qualia roles.

Busa argues that the GL theory is able to handle nominalization, viewed in syntax as a category-changing operation, which requires the positing of an abstract verbal category **auth** for the nominal **author**. Busa (1996: 28) maintains that the nouns **author** and **writer** share semantic similarities which are not derived from the verbal category **write** and the hypothetical **auth**, but rather from the semantic type: namely, they both refer to individuals which are defined with respect to a particular event. She further states that an event cannot be identified without a complement which defines the individual. She considers the examples in (154) below.

154. (a) the author of the book
(the writer of the book)
- (b) the author of this painting
(the painter of this painting)
- (c) the author of the robbery
(the perpetrator of the robbery)

Busa suggests that the additional differences in the semantic information carried by the two nominals are pointed out by the availability of different adjectives. She provides the examples in (155) illustrate this aspect.

155. (a) frequent / former writer
 (b) frequent / former author

Busa (1996:29) is of the view that agentive nominals should have at least the following properties:

- (i) A set of compositional devices for deriving the polymorphic behavior of agentive nominals generatively, given that they are subject to sense shifts in context.
156. (a) The pianist hit the wrong key.
 (i.e. the one who is playing the piano now)
 (b) My grandfather was a pianist.
 (i.e. had the ability to play the piano, that was his job)
- (ii) A representational structure which allows us to distinguish between stage-level and individual-level agentive nominals, from which we can predict their syntactic behaviour, as in (4) below.
157. (a) A pedestrian was hit by a car.
 (i.e. hit while walking)
 (b) A carpenter was hit by a car.
 (i.e. hit while building furniture OR while doing something else)
- (iii) A framework for establishing the temporal relations between individuals and events:
158. (a) !The fugitive is in jail.
 (b) !Jimmy married his fugitive widow.
- (iv) A theory of event structure which allows us to draw the appropriate distinctions between a variety of nominals i.e. **runner, winner, builder, lover**, and so on.

- (v) An account of the quantificational properties of events to capture the generic –like character of the set of ILNs.

3.5 INDIVIDUAL-LEVEL AND STAGE-LEVEL DEVERBAL NOUNS: EVENT STRUCTURE PROPERTIES

The main purpose of this section is to briefly review the history of research on events in linguistic theory, and to consider the proposal for determining an integrated theory of events in the grammar of natural language. This is done by examining the different perspectives advanced by various linguists and philosophers in the development of a linguistic theory on events. The notion of events as grammatical objects has been looked at from the viewpoint of Lexical Semantics, Logical Semantics and Syntax in previous studies. There is some convergence on events from these subfields that has developed across them. It is on this basis that this section will examine how events have developed.

Pustejovsky (2000: 3) observed that lexical semantics (which focuses on the meanings of individual words), and logical semantics (which studies the compositional properties of propositional interpretation i.e. attitudes and judgments), have traditionally different tools to address distinct aspects of semantic composition. He further states that these two approaches have moved closer together as events and event structures have entered the field as representational devices. On the other hand, syntacticians have discovered a phenomena in which the semantics of events can be seen to interact with syntactic structures, and had to turn to semanticists for representations of the properties associated with events.

3.5.1 The aspectual structure of verb meanings

Aristotle (384-322) provided the first aspectual classification, a typology of events based on their internal temporal structure, and semantically unlimited events. According to Pustejovsky, Vendler (1967), laid out a four-way typology of aspectual verb classes, states which have no internal structure or change during the span time over which they are true, as in (**love**, *Boris loves Mary*), activities which is an ongoing event with internal change and duration, as in (**walk**, *Boris walked along the river*), achievements which have an instantaneous culmination or endpoint and are without duration, as in (**arrive**, *Kevin arrived in London*), and accomplishment being events with duration and an obligatory temporal

endpoint, as in (**consume**, *Linda consumed the fish*). These four classes are based on temporal properties such as temporal duration, temporal termination, and internal temporal structure (or the lack of it).

Pustejovsky points out that the use of the term events prompted Bach (1981) to coin the term “eventualities” to include all aspectual types, stative and eventive. According to Pustejovsky, Verkuyl (1972), and Jackendoff (1990), referred to the property of an event having or not having a temporal endpoint as the bounded / non-bounded distinction. Moens, Steedman (1988), Smith (1991), and Teny (1987, 1994) argued for the culminating / non- culminating distinction, the telic / atelic distinction, and the delimited / non-delimited distinction. Pustejovsky states that Dowty (1979) referred to accomplishment and achievement verbs as definite change of state predicates, and Quine (1960), Hinrichs (1985) make a distinction between telic and atelic events in terms of homogeneity, whereas, Taylor (1977), Krifka (1992) define them in terms of cumulativity.

Haas et al (2008: 1) focused on the aspectual properties of deverbal nouns on the basis of a hypothesis which advocates that deverbal nouns inherit certain semantic aspectual properties from the verbs they derive from. There are three areas of focus where these aspectual properties are examined. Firstly, the main goal of his study is to find traces of such properties.

Secondly, he addresses the general question of determining to what extent nominals convey aspectual properties. Thirdly, he explores the problem of finding adequate aspectual tests for the nominal domain. Haas et al utilise the Vendler method of classifying the aspectual classes and properties / features for verbs, as illustrated in (159).

159.

	Dynamicity	Delimitedness	Duration	
State	–	–	–	to fear
Process	+	–	+	to push
Accomplishment	+	+	+	to write (a book)
Achievement	+	+	–	to explode (a bomb)

Nouns derived from:

- States: admiration, attraction
- Processes: gardening, discussion
- Accomplishment: labor, filming
- Achievement: explosion, discovery

Haas et al refer to Huyghe (2006) who states that events are finite entities which can be directly placed and /or temporal domain, in virtue of their existential autonomy. They further state that only events can appear as N in *N has taken place in X* (a place or a moment) or in *The place of N*. Haas et al point out that nouns derived from both accomplishments and achievements can denote events:

160. (a) The filming / labor has taken place in Paris / this morning.
 (b) The place of filming / of the labor.
160. (a) The explosion / landing has taken place in Paris / this morning.
 (b) The place of the explosion / landing.

Haas et al further point out that nouns derived from states are not allowed in the following constructions:

161. (a) *The admiration / the attraction has taken place in Paris / this morning.
 b. *The place of the admiration / of the attraction.

They state that nouns derived from processes are also rejected, (162), yet some are not rejected, as is illustrated in (163) below:

162. (a) *The gardening / the swimming has taken place in Paris / this morning.
 (c) *The place of the gardening / of the swimming.
163. (a). The discussion / the demonstration has taken place in Paris / this morning.

- (b) The place of the discussion / of the demonstration.

Haas et al (2008: 3) assert that there are two types of processive nouns: (i) mass ones and the count nouns. They further refer to Heyd And Knittel (2006) who state that only count nouns can be pluralised:

164. (a) *The gardenings are good for the health.
 (b) *Several gardenings / three gardenings / gardenings (bare plural).
165. (a) The discussions with Paul are always interesting.
 (b) Several discussions / three discussions / discussions (bare plural).

Haas et al indicate that mass nouns accept partitive article, while count ones do not, as is illustrated in (166) and (167) respectively.

166. Paul makes of the gardening / of the swimming.
 167. *Paul makes of the discussion / of the walk.

They further state that only mass nouns are allowed in the structure N-singular, whereas, count noun are only acceptable in plural, as shown in (168) and (169).

168. (a) Pierre makes a lot of gardening.
 (b) *Pierre makes a lot of gardenings.
169. (a) * Pierre makes a lot of walk.
 (b) Pierre makes a lot of walks.

Haas et al argue that nominals such as **discussion** are hybrid: they are count nouns, delimited from a nominal point of view; but they derive form non-delimited verbs, as is illustrated in (170) below.

170.

Verbal domain			Nominal domain				
Aspect	Delimitedness		Examples	Examples	Delimitedness		Aspect
Acc. & ach.	+	telic	repair	reparation	+	count	event
Process	-	non-telic	garden	gardening	-	mass	non-event
	-	non-telic	discuss	discussion	+	count	event?

They suggest that nouns of the discussion –type denote events even if their internal structure does not include a culminant point, as can be shown in (171)-(172) below:

171. Two hours of discussion / of walk.
 172. Two hours of gardening / swimming.

Haas et al conclude that nouns derived from accomplishments and achievements denote events, while nouns derived from states do not.

3.5.2 Stage-Level and Individual-Level Predicates

According to Pustejovsky, the distinction between stage-level and individual-level predicates has received attention from Carlson (1977). Carlson argued that stage-level predicates are predicated of stages, and represent a temporary or transitory quality (a), while individual-level predicates are predicated of individuals, and represent more permanent qualities (b):

173. (a) Firemen are available.
 (b) Firemen are intelligent.

Pustejovsky notes Kratzer's (1995) proposal that stage-level predicates differ from individual-level predicates in having an extra event argument in their representations, whereas, Diesing (1988) has argued that subjects of stage-level predicates are generated in the position of Specifier of the Verb Phrase [Spec, VP], while subjects of individual-level predicates are generated in the position of Specifier of the Inflectional Phrase [Spec, IP].

Busa (1996:16) argued that all agentive nominals are best characterized in terms of events irrespective of whether or not the event which defines an individual is presupposed. Busa further states that different interpretations emerge as the result of the event type of the action that characterizes the agentive noun as well as the quantification of that event. Busa (1996: 20) refers to Pustejovsky (1995) who observed that nouns which denote participants in an event fall under two general classes, according to whether or not they require the context to make reference to the defining characteristic of the individual. She considers the sentences in (174) and (175) illustrate this aspect.

174. When we bumped into the *guitarist*, at the Grand Parade.

- (a) he_i was playing a melody on a street corner.
- (b) he_i was selling apples on the street corner.
- (c) he_i was a street vendor.

175. When I saw a *pedestrian* at the Grand Parade.

- (a) he_i was about to get off a truck.
- (b) he_i was selling apples on the street corner.
- (c) he_i was a street vendor.

Busa states that reference, to the **guitarist** in (2), can be done irrespective of whether the individual is engaged in the activity of “playing the guitar” at the time. According to Busa, reference to a noun such as **pedestrian** in (3), can be done only if the individual is walking at the time of reference. Busa further states that given that **guitarist** does not establish the same constraints relative to the identification of the individual, it is possible to predicate additional properties of the individual that hold simultaneously with the property of being a **guitarist** (cf. 2). According to Busa, the noun **pedestrian** on the other hand requires the matrix predicate to be consistent with the defining event. She asserts that the two nominal types behave differently in composition with locative and temporal PPs, as in (176) and (177) below.

176. (a) Watch out there is a pedestrian on the crosswalk! (locative modifier) (i.e. pedestrian is walking on the crosswalk)
- (b) The pedestrians at noon are always very irritable. (temporal modifier) (i.e. pedestrians walking at noon)

177. (a) Watch out there is a guitarist on the crosswalk! (locative modifier)
 (i.e. guitarist is playing on the crosswalk)
- (b) The guitarists at noon are always very irritable. (temporal modifier)
 (i.e. guitarist playing at noon)

Busa (1996: 21) states that in (176) above, the PPs are modifying the event of walking whereas in (177a) the modifiers make reference to the location of the individual and not of the event. Busa (1996) cites Randall (1982) who claims that there are cases where the modifier can indeed modify the event even with **guitarist**, as in (178) below.

178. The violinist on the stage does not have enough light.

Busa claims that the data in (176) and (177) point to the distinction discussed by Chierchia (1995) in the domain of individual-level and stage-level predicates. Busa further states that spatial modifiers, as in (179), and temporal modifiers, as in (180) are available with stage-level predicates, but not with individual-level predicates.

179. (a) I saw Jane in the garden. (*stage-level*)
 (b) I know Spanish in Brazil. (*individual-level*)
180. (a) I saw Mavis today. (*stage-level*)
 (b) Mavis knew Joseph. (*individual-level*)

Busa (1996: 22) citing Rappaport and Levin (1992) claims that a distinction between nominals that pattern with **guitarist** and those that pattern with **pedestrian**, should account for a number of additional facts, among which the availability of frequency adjectives with certain nominals and not with others, as in (181) – (182) below.

181. (a) a frequent passenger / patron: (stage-level nominal)
 (b) !a frequent guitarist / teacher: (individual-level nominal)
182. (a) !!Jimmy is always a guitarist.
 (b) !!Jimmy is always a smoker.
 (c) Jimmy is always a pedestrian.

Busa (1996: 22) cites Kratzer (1989, 1995) who introduced a distinction between stage-level nominals (SLNs) and individual-level (ILNs) through the availability of when-clauses, as is illustrated below.

183. (a) !!When Jimmy knows Spanish, he knows it well.
 (b) When Jimmy speaks Spanish / a language, he speaks it well.

184. STAGE-LEVEL NOMINALS (SLNs)
 (a) When Jimmy is a passenger, he gets car-sick.
 (b) When Jimmy is a patron, he loves to spend money.
 (d) When Jimmy is a fugitive, he hides at Mavis's house.

185. INDIVIDUAL-LEVEL NOMINALS (ILNs)
 (a) When Jimmy is a carpenter, he is creative.
 (b) !When Mavis is a wife, she is sweet.
 (c) !When Mavis is a smoker, she coughs a lot.

Busa (1996: 23) points out that the above distinction has the potential to account for semantic peculiarity of certain nominals as was observed by Gupta (1980), and which is illustrated in the examples below.

186. (a) Twelve patrons / customers came in today.
 (b) I have seen ten doctors in the last month.

Busa indicates that in (186a), the number of patrons may be twelve or less since the same individual might have visited the business more than once. In (186b), the number of doctors is exactly ten. Busa elaborates by stating that SLNs can either make reference to the individuals involved in the events or to the events themselves, while with ILNs this option is not available.

3.5.2.1 Distinctions within the set of individual-level nominals

Busa (1996: 24) argues that the class of ILNs is not fully homogenous since **smoker** and **guitarist** differ in important ways. Whereas a **smoker** refers to an individual who has the

habit or the inclination to smoke with some regularity, a **guitarist** can be minimally characterized as an individual who has the ability to play the guitar. Busa specifies that the crucial involvement of predicates such as **habit** and **ability** in the semantics of ILNs accounts for the properties of this class of agentive nouns. She points out that the predicates **ability** and **habit** differ fundamentally in terms of the context in which they are used. According to Busa, this in a way explains the contrast in (187)-(188) below.

187. (a) Jimmy is a guitarist but doesn't play guitar anymore.
 (b) Jimmy is an alcoholic but doesn't drink anymore.
188. (a) !! Jimmy is a smoker but doesn't smoke anymore.
 (b) !! Jimmy is a drinker but doesn't drink anymore.

Busa (1996: 25) maintains that the same explanation that accounts for the examples above, should also cover the different entailments of **guitarist** and **smoker** in composition with the adjective **former**.

189. Jimmy is a *former* guitarist / musician / teacher. (*sense* ₁)
 ⇒ Jimmy is a guitarist / musician / teacher. (*sense* ₂)
190. Jimmy is a *former* smoker / drinker.
 ⇒ Jimmy is a smoker / drinker.

Busa specifies that the extensional component which is introduced by **habit** and absent with **ability** accounts for the entailments in (189) and (190). She further states that evidence for the semantic contribution to the interpretation of these nominals of the stative predicates **habit** and **ability** is also provided by the compositional interpretation of agentive nouns with different adjectives. She states that the adjectives that make reference to an **ability**, such as natural or talented are ruled out with **smoker** and **drinker**.

191. (a) !!a natural smoker / drinker
 (b) !!a talented smoker / drinker

Busa states that adjectives that make reference to the occurrence of a habit are licensed with **smoker** but not with **guitarist**, as is shown in (192) below.

192. (a) habitual / frequent / moderate drinker / smoker
 (b) !! habitual / frequent / moderate guitarist / alcoholic

- **Individual –Level Agentive Nominals**

Busa (1996) explains properties specifies first the characterization of the lexical properties of individual-level nominals. She also discusses the question of how the properties of individual-level nominals can be encoded in a qualia-based representation which is able to make the desired distinctions and explain the syntactic and semantic properties of agentive nominals. In addition, she addresses the distinction between individual-level nominals and agentive nominals denoting instruments.

(Busa 1991:66) is of the view that one of the crucial properties of individual-level nominals is that the individual is defined as α – **er** need not be engaged in the activity α at the time of reference. She argues that the context need not make reference to the defining characteristic of the individual, and that there is no temporal constraint between the event characterizing the individual and the matrix predicate. She considers the alternations in (193)-(194) below.

193. When we met the *violinist*, on the Hospital bend, (ILN)
 (a) he, was in Cape Town playing on a street corner.
 (b) he, was selling hot-dogs on a street corner.
 (c) he, was a street vendor.
194. When I saw a pedestrian, on the Hospital bend, (SLN)
 (a) he, almost got runover
 (b) !he, was selling hot-dogs on a street corner.
 (c) !he, was a street vendor.

Busa (1996: 67) maintains that reference to **violinist** can be done without the individual being engaged in the activity of “**playing the violin**”, whereas reference to **pedestrian** can only be

done if the individual is walking at the time of reference, hence the oddness of (193b) and (194c). She suggests that there is a need to explain the manner in which the defining event α is crucial in the interpretation of the nominal, even if α need not occur at the time of reference, when analyzing the behavior of individual-level nominals. Busa points out that unlike stage-level nominals, individual-level nominals fail to license frequency adjectives, as is shown in (195) versus (196) below.

195. (a) ! Frequent violinists have callous fingers.
 (b) ! Frequent doctors are more competent.
196. (a) Frequent passengers with British Airways have considerable advantages.
 (b) Gianni give a discount only to frequent customers.

Busa points out that this behavior is parallel to that between stage-level predicates:

197. (a) Gianni is frequently intelligent / tall. (individual-level)
 (b) Gianni is frequently available / drunk. (stage-level)

Busa proposes that the distinction in (195) and (196) can be explained in terms of persistent and situated properties of individuals. Busa further suggests that the role of events in the interpretation of agentive nominals should also account for why when referring to an individual-level nominals, individuals are counted, while with stage-level nominals it is either individuals or the events themselves involved in the events that can be counted, as is illustrated in (198) below.

198. (a) Maria was visited / seen by seven doctors. (i.e. seven individuals)
 (b) Today we had only twenty customers. (i.e. twenty individuals or twenty events)

Busa (1996: 69) outlines the distinction between stage-level and individual-level predicates by citing Kratzer's (1995) analysis of the following sentences:

199. (a) Manon is dancing on the lawn.

- (b) Manon is dancing this morning.
- (c) Manon is a dancer.

Busa maintains that in (199a-b), the predicate *be dancing* is a stage-level predicate since it licenses spatial (e.g. **on the lawn**), and temporal (e.g. **this morning**) modifiers. Busa cites Kratzer (1995) who assumes that the representation of stage-level predicates includes the variable 'I' ranging over spatio-temporal locations. She argues that the analysis of (199c) is based on the assumption that the predicate **be a dancer** is an individual-level predicate lacking the variable 'I'. There seems to be no clarity on the kind of relation the expression **be a dancer** bears to the noun **dancer** itself, and in turn what the relation the latter bears to the verbal form **dance**. She considers the examples in (200), where the nominal is in a predicative position.

- 200. (a) Manon is a doctor.
- (b) When in Cape Town, Kaiser is a pedestrian.

Busa (1996: 70) states that in (200a) the predicate *be a doctor* is an individual-level predicate, however, in (200b) **be a pedestrian** is stage-level predicate. She proposes further supported by the availability of event quantifiers with (200b), but not with (200a), as illustrated in (201).

- 201. (a) !Manon is often a doctor.
- (b) Bob is often a pedestrian.

Busa examines the issue of whether the absence of an event position with individual-level predicates can account for the associated grammatical phenomena. She refers to Kratzer's sentence (200a), **Manon is a dancer**, which lacks an event position, and adds a temporal or a locative modifier to the example. A temporal or a locative modifier has the effect of causing the predicate to shift to a stage-level interpretation, as is illustrated in sentence (202) below.

- 202. (a) You were some dancer last night.
- (b) Hey Simon, that's quite a dancer on that table!

Busa (1996: 71) argues that the licensing of a nominal by either a temporal or a locative modifier requires a certain emphasis for the predicate to shift to a stage-level interpretation.

She states that in circumstances where there is no emphasis, a stage-level interpretation is not as clear as it ought to be even with the presence of some modifiers. She considers the sentences in (203).

203. (a) !!Joseph was a dancer last night.
 (b) !!Joseph was a dancer on that table.

Busa argues that the PP modifiers cannot readily be interpreted as modifiers of events unless the defining event is existentially quantified by various forms of focus. She proposes that agentive nominals which are underlyingly stage-level nominals (SLNs) are licensed with PP modifiers indicating the locative of the event, whereas, individual-level nominals do not license locative and temporal PPs unless their interpretation is shifted to stage-level in composition with adjectives. Busa refers to the polysemy of the nominal **builder** in (204) below.

204. (a) Gianni is a builder.
 (b) The builder of this house is my grandfather.

Busa (1996: 72) states that in (204b) a particular event of building is interpreted as having occurred, because of the presence of the definite NP complement, hence the noun **builder** is interpreted as a stage-level noun. Busa refers to Rappaport and Levin (1992) who first distinguished two classes of agentive nouns in terms of an event position in the parameter list of the nominal, and, secondly, claim that there is no event which defines a noun such as **builder**. She suggests that such a claim is misleading as nouns such as **dancer** and **builder** carry quantificational information about some event, and that the event may be further specified relative to some occupation or other habitual activity. She asserts that all agentive nominals have an event position, be they stage-level or individual-level, and that the different interpretations can only be captured by providing lexical items with structured semantic information which ought to be richer than the argument structure.

- **The source of lexical genericity**

Busa examines issues concerning quantification of the defining event by characterizing the source of the genericity associated with individual-level nominals (ILNs), since this class of

nouns denote individuals for whom the defining event appears to have a generic interpretation.

Busa (1996: 74) cites Pustejovsky (1995) and Chierchia (1995) concerning the proposition that nominals with a habitual / generic interpretation should be treated as individual-level nominals, a notion which appears to be consistent with the view that individual-level predicates are inherently generic. Busa discusses the notion of genericity by referring to Chierchia who introduces the generic operator *Gen*, which quantifies over situations with associated felicity conditions. Busa mentions that for quantificational adverbs such as **always** the felicity conditions are expressed by means of a contextual variable *C*, as is illustrated in the representation below.

205. (a) John always smokes.
 (b) $s(C(j, s) [\text{smoke}(j, s)])$

Busa asserts that the restriction on the generic operator is given by specifying the contextual variable *C* to the arbitrary location, as in (206) below, indicating that the felicity conditions are satisfied if the individual has the property of being located anywhere.

206. (a) John is a smoker.
 (b) $\text{Gen } s(\text{in}(j, s) [\text{smoker}(j, s)])$

Busa (1996:75) proposes that sentence (202a) says that **John is a smoker** irrespective of where he is or what he is doing, given that *Gen* imposes only the restriction of being located anywhere, thereby capturing the stable properties of individual-level predicates. Busa (1996) cites Krifka et al. (1995), who also pointed out that agentive nominals have a generic meaning, as is illustrated in (207) below, where the agentive nominal in predicative position gives a generic character to the whole sentence.

207. John is a pipe smoker.

Busa (1996) maintains by saying that although the notion of habituality or genericity is a crucial component of the interpretation of ILNs, it is both too strong and too course-grained to

capture properly the range of interpretations. She considers the nominals **violinist** or **smoker** in (208) and (209) below:

208. (a) John is a violinist but doesn't play anymore.
 (b) John is an alcoholic but doesn't drink anymore.
209. (a) !!John is a smoker but doesn't smoke anymore.
 (b) !!John is a drinker but doesn't drink anymore.

Busa (1996:78) explains that a person does not play anymore is consistent with what a violinist is, the same statement about the characterizing event of smoking is a contradiction. She is of the view that the initial generalizations that emerges is that both **violinist** and **smoker** make reference to dispositions, in particular, the stative property of dispositional predicates such as **ability** and **habit**, responsible for the persistency associated with ILNs, which makes them analogous to individual-level predicates.

- Dispositional and non-dispositional states in the semantics of individual-level nominals (ILNs)

Busa explores the different interpretations of a variety of stative predicates which provide the modal base for distinguishing between different types of ILNs. Busa refers to Krifka et al (1995) who suggests that stative predicates can either be dispositional (i.e. *know*) or non-dispositional (i.e. *be married*), and in both cases they lack reference to a specific situation. Busa states that such an observation is crucial for characterizing the semantics of ILNs. She considers the distinction between **doctor**, **lawyer**, **wife**, and **mayor**.

Busa (1996:79) argues that the modality associated with **doctor** and **lawyer** corresponds to epistemic modality which requires a particular ability. Nouns such as **wife** and **mayor** are brought about as a result of some form of contractual agreement i.e. marriage or election. She elaborates that as long as the contractual agreement holds, the nominal displays stable properties with respect to that state. She suggests that viewed in terms of the properties of stative predicates, these two sets of ILNs differ from **smoker** and **violinist** in that the defining

event is dependent on a non-dispositional state. She considers first the contribution of the dispositional predicate **ability**, below.

210. John has the ability to swim.

Busa (1996:80) states that the predicate **ability** is a relation between the state of an individual and a possible event, give that such event is required to take place. She considers the predicate habit in the sentence below.

211. John has the habit of swimming.

Busa (1996) explains that the sentence in (211) has a relation between the state of an individual and an event which takes place with regularity. She further suggests that a habit makes reference to partly extensional and partly to intensional events, or equivalently past and projected events. She proposes that the availability of different types of stative predicates in the semantics of ILNs is further motivated by the interpretation of a variety of adjectives. Adjective that make reference to an ability, such as **natural** are ruled out with **smoker** and **drinker**, as is illustrated in (212) below.

212. (a) !!a natural smoker / drinker
 (b) !!a talented smoker / drinker

Busa (1996: 83) maintains that adjectives that make reference to a certain habit are licensed with **smoker** but not with **violinist**, as is shown in (213) below.

213. (a) habitual / frequent / moderate drinker / smoker.
 (b) !! habitual / frequent / moderate violinist / alcoholic.

Busa considers the different entailments that are associated with ILNs in composition with the adjective **former**, as is shown in (214) and (215).

214. John is a former violinist / musician / professor. (sense₁ = occupation)
 ⇒ John is a violinist / musician / professor. (sense₂ = ability)

215. John is a former smoker / drinker.

≠ John is a smoker / drinker.

Busa explains that sentence (214) does not say that John formerly had the ability to play the violin, and he no longer has such ability, rather violinist, musician and professor assume a different sense, namely John used to perform the activity with regularity. Conversely, in (215) former mentions that there is an activity or state that used to hold in the past and no longer holds.

- **The qualia structure representation of individual-level nominals (ILNs)**

Busa shows that a solution based on a model that provides the nominals with internal semantic structure accounts for how the quantificational properties of the defining event interact with context to provide different interpretations through composition. Busa (1996: 84) suggests that given this model of lexical representation, the individual-level properties of agentive nouns can be straightforwardly expressed in the qualia structure of the noun. She posits the qualia structure representation of nominals such as **violinist** and **smoker**, as is shown in (216) below.

216. (a)

violinist		
FORMAL	=	“person”
TELIC	=	“play violin”

(b)

smoker		
FORMAL	=	“person”
TELIC	=	“smoke”

Busa states that the AGENTIVE role makes reference to an expression which is a necessary condition for that individual to be what it is, e.g. the mode of coming into being. She suggests that the difference between the variety of ILNs can be captured by refining the distinction in terms of different modes of “coming into being” of an individual. With **violinist** it is the modal **ability** and with **smoker** it is the partly extensional predicate **habit**. She provides the

resulting qualia structure representations for the two nominals given in (217) and (218) below.

217.

violinist	FORMAL	=	“person”
FORMAL	=	“person”	
TELIC	=	“play violin”	
TELIC	=	“play violin”	
AGENTIVE	=	“ability to play violin”	
AGENTIVE	=	“ability to play violin”	

218.

smoker	FORMAL	=	“person”
FORMAL	=	“person”	
TELIC	=	“smoke”	
TELIC	=	“smoke”	
AGENTIVE	=	“habit to smoke”	
AGENTIVE	=	“habit to smoke”	

Busa (1996: 86) states that a noun such as **violinist** falls into the set agentive nominals that can be characterized as modal ILNs. Busa further suggests that this is the result of the semantic properties of the stative predicate **ability**, which induces an opaque reading of the event in its parameter list, which in the case of **violinist** is the defining event of “**playing the violin**”. She considers the resulting representation for the nominal **violinist** given in (219) below.

219.

violinist	ARGSTR	=	ARG 1 = x:human
ARGSTR	=	ARG 1 = x:human	
EVENSTR	=	D- € 1 = e ₁ : process	
EVENSTR	=	D- € 2 = e ₂ : state	
EVENSTR	=	REST = e ₂ < _α e ₁	
EVENSTR	=	REST = e ₂ < _α e ₁	
QUALIA	=	FORMAL = x	
QUALIA	=	TELIC = λx play (e ₁ , x, violin)	
QUALIA	=	AGENTIVE = ability (e ₂ , x, 1)	
QUALIA	=	AGENTIVE = ability (e ₂ , x, 1)	

Busa explores the question of how the representation provided for the different ILNs account for the availability of complements with certain nouns i.e extensional-individual-level nominals (ILNs), but not with modal- individual-level nominals (ILNs). The analysis involves exploring additional issues concerning syntactic derivation, since the forms involving the productive morpheme **-er** appear to behave differently from the lexically encoded base-forms.

She raises concerns as to whether there is any way to predict whether the **AGENTIVE** role of an individual-level nominals (ILNs) encodes a modal or an extensional predicate with regard to

the productive morphological processes. Put differently, are nominals derived by means of **er**-affixation always extensional? Busa is of the view that whether the event α that characterizes an individual is interpreted relative to an **ability** or a **habit** that is dependent on what α means. She further states that relative to issues concerning the expressibility of complements, the productive affix does play a role.

Busa considers the nominals **driver**, **driver of vehicles** and **truckdriver**. She argues that the nouns **driver of vehicles** and **truck driver** are both denominal agentive nouns derived from **automobile / vehicle** and **truck**, and that the two nouns differ in licensing complements, as is illustrated in (220) below.

220. (a) the driver of the vehicle:
 (b) the driver of the truck:
 (c) the truckdriver of the truck:
 (d) the truckdriver of the???truck:

Busa asserts that the noun **driver of vehicles** licenses shadow arguments, given that the argument makes reference to the general type **vehicle**, whereas, **truckdriver** makes reference to the more specific type **truck**. She suggests that the nominal **driver** appears to be polysemous between individual-level and stage-level interpretations, and that it also licenses its complements, as is illustrated in (221) below.

221. (a) The driver of the red vehicle got distracted. (stage-level)
 (b) Gianni is a driver of buses. (individual-level)

Busa (1996: 95) is of the opinion that nominals directly derived from an event description, e.g. **drive**, inherit the properties of that event, such that in the case of a process both the habitual / generic reading and the specific reading of the activity are available. She argues that in describing the relation between the syntax and the semantics of the derived nominal, it can be imagined that they involve different derivations corresponding to potentially distinct levels of representation.

Busa posits that the nominals **violinist**, and **truck-driver**, are related to the nouns **violin**, and **truck** respectively. She states that in the GL theory these nouns have a TELIC role specified, as illustrated in the simplified entries in (222) below.

222. (a)
$$\left[\begin{array}{l} \text{Violin} \\ \text{ARGSTR} = \left[\begin{array}{l} \text{ARG1} = x:\text{instrument} \\ \text{D-ARG1} = y:\text{human} \end{array} \right] \\ \text{QUALIA} = \left[\begin{array}{l} \text{FORMAL} = x \\ \text{TELIC} = \text{play} (e^p, y, x) \end{array} \right] \end{array} \right]$$

(b)
$$\left[\begin{array}{l} \text{truck} \\ \text{ARGSTR} = \left[\begin{array}{l} \text{ARG1} = x:\text{instrument} \\ \text{D-ARG1} = y:\text{human} \end{array} \right] \\ \text{QUALIA} = \left[\begin{array}{l} \text{FORMAL} = x \\ \text{TELIC} = \text{play} (e^p, y, x) \end{array} \right] \end{array} \right]$$

As , according to Busa, the set of nouns such as **terrorist**, **artist**, and **miniature**, are also related to a noun but they refer to individuals who bring about that event or object. She considers the nominal **miniature** in (223).

223.
$$\left[\begin{array}{l} \text{miniature} \\ \text{ARGSTR} = \left[\begin{array}{l} \text{ARG1} = x:\text{phys_obj} \\ \text{D-ARG1} = y:\text{human} \end{array} \right] \\ \text{QUALIA} = \left[\begin{array}{l} \text{FORMAL} = x \\ \text{TELIC} = \text{play} (e^s, z, x) \\ \text{AGENTIVE} = \text{paint} (e^T, y, x) \end{array} \right] \end{array} \right]$$

Busa (1996: 96) specifies that the TELIC role of **art** and **miniature** is a relation such as enjoy or look at, and, the derived agentive noun is not the individual who enjoys **art**, or who looks at **miniature**, but the person who creates art work, and who paints **miniatures**. She further explains that one way to determine that the defining event make reference to the AGENTIVE

rather than the TELIC is by constraining the derivation on the basis of the event type. She considers the relation in (224) between a noun and a correlated denominal agentive noun.

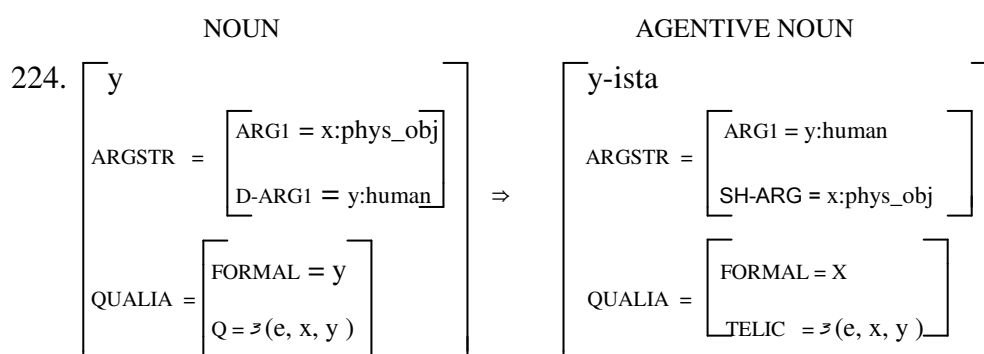

Busa explains that the above derivation involves incorporating the noun y into the meaning of the agentive nominal $y\text{-ista}$ where the whole relation in the relevant quale of y , i.e. $\exists(e, x, y)$, is maintained in the agentive noun. She also considers the relation between the event description and the agentive noun for the nominals **smoker**, **drinker**, and **player**, as is illustrated in (225) and (226).

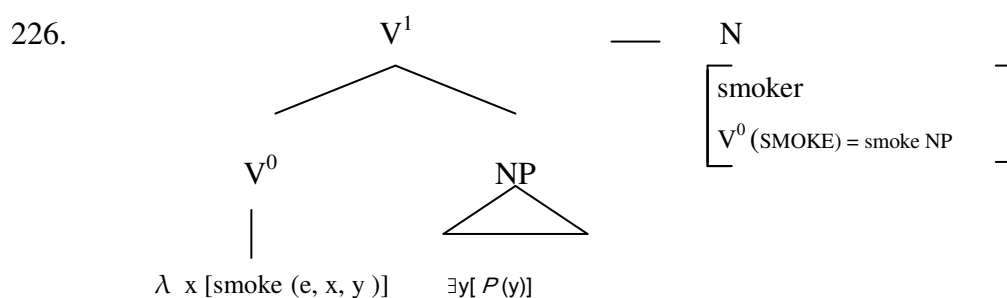
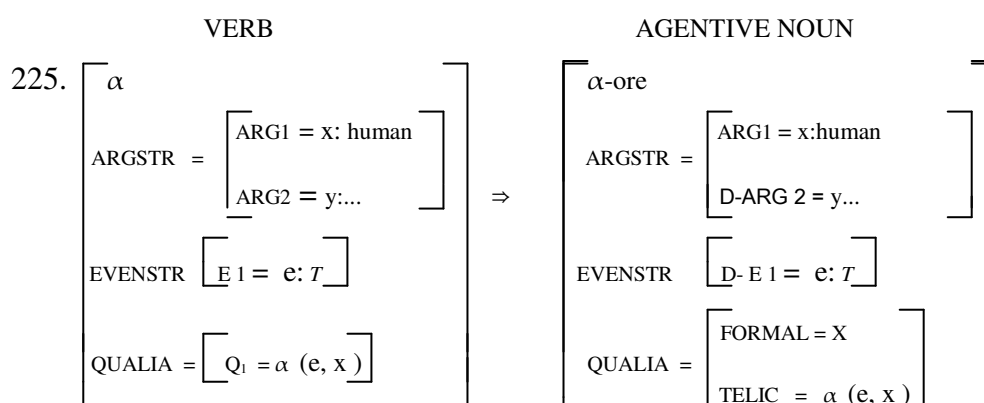

Busa (1996: 99) claims that the derivation in (226) corresponds to a V^0 nominalization, which would partially account for the availability of complements with nominals such as **smoker** and **drinker**, as is illustrated in (227) below.

227. (a) a smoker of Rothmans:
 (b) a drinker of whiskey:

Busa considers as to whether within the nominal domain complements are expressed under a different set of constraints from those of the verbal forms. She refers to (Hinrichs, 1985, Krifka, 1992, Verkuyl, 1993) who argued that an argument may affect the aspectual interpretation of the whole VP structure, consider for instance, the examples mentioned by Krifka (1992):

228. (a) John ran for an hour / *in an hour.
 (b) John ran a mile *for an hour / in an hour.
229. (a) John saw a zebra for an hour / *in an hour.
 (b) John saw zebras for an hour / *in an hour.

Busa argues that the lexical semantics of the verb plays a fundamental role in the way the type (i.e. mass / count) of an argument affects the interpretation of the complex expression, in (228) above, the verb is sensitive to different forms of quantifications, while in (229) that is not the case. She states that for individual-level nominals (ILNs), a complement may not affect the aspectual interpretation of the defining event, although that is possible with the verbal form. She considers the sentences in (230) below, where the correlated agentive noun does not inherit any of the properties of the verbal form:

230. (a) John runs / has run. (activity)
 (b) John ran 5 miles. (accomplishment)
 (c) John ran the marathon. (accomplishment)
 (d) John ran to the store. (achievement)

- **Sense extension phenomena**

Busa examines the compositional operations which trigger meaning shifts in the interpretation of individual-level nominals (ILNs). Busa (1996:103) is of the opinion that in Generative Lexicon (GL) the most desirable analysis of polysemous lexical items is to have the different senses emerge in composition rather simply by enumeration. She examines the multiple senses associated with individual-level nominals (ILNs), as is illustrated in (231) below.

231. (a) John is a *violinist* for Cape Town Symphony Orchestra. (Occupation)
 (b) The first *violinist* is sick. (role)
 (c) Mary is a good *violinist*. (ability)
 (d) The *violinist* broke a string. (stage-level in context)

Busa specifies that in order to account for the “sense in context” for the agentive nominals in (231), it is necessary to determine which components of the semantic representation are fixed and which components vary as the result of additional information. She compares the occupational reading of **violinist** in (232b) with the nominal **smoker**.

232. (a) John_i is a violinist but he_i does not play anymore.
 (b) !John_i is an employed violinist but h_i does not play anymore.
 (c) !John_i is a smoker but he_i does not smoke anymore.

Busa provides that a related sense shift phenomenon which also involves co-composition concerns the expressibility of certain complements. She considers the following expressions in (233) below.

233. (a) the first violinist of the orchestra
 (b) the chef of King’s restaurant

Busa (1996:109) suggests that in the expressions in (233) the complement contributes to further specifying the situations in which the defining event is likely to occur. Busa further states that this specification takes place in composition as the result of the information provided by the complement. In (233) above the complement triggers a role reading of the

individual by contributing information relative to the CONSTITUTIVE role. She considers the derivation in (234).

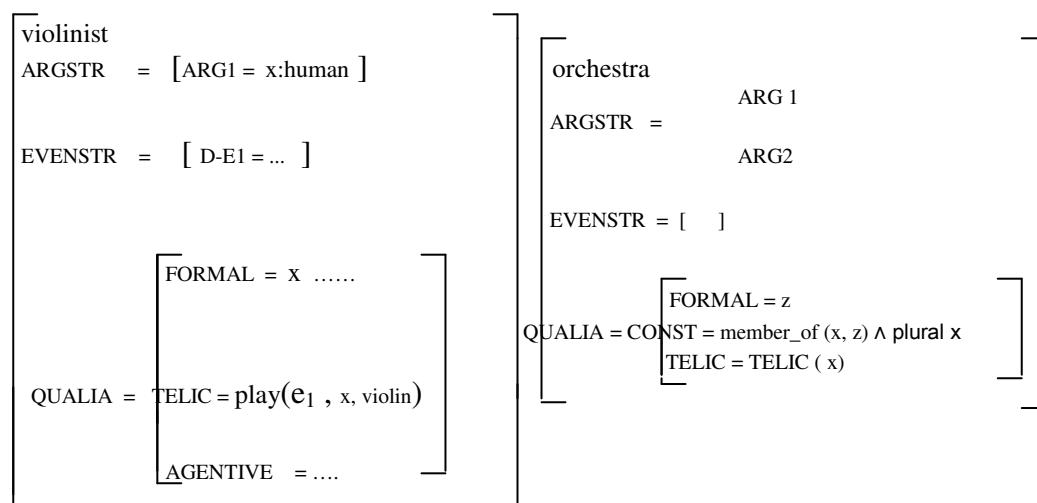
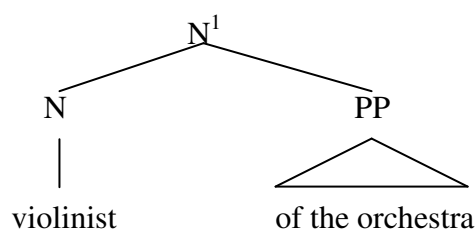
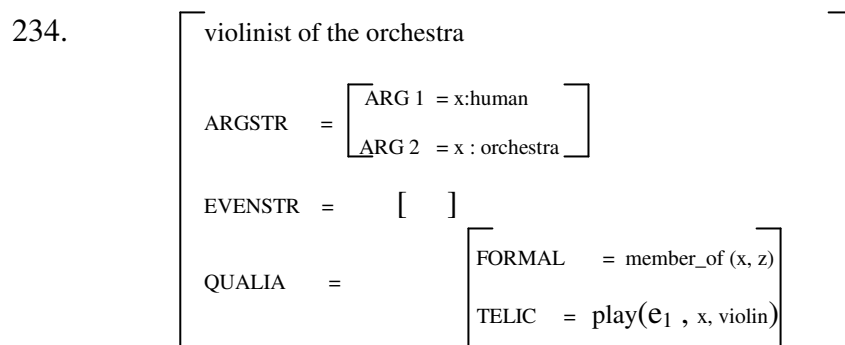

Busa (1996:110) states that the composition of an agentive noun with a complement having a group-like or CONSTITUTIVE element derives a relational interpretation at N¹ level, and that the co-compositional operation illustrates the role of complements with individual-level nominals (ILNs). Busa further elaborates that the expression **violinist of the orchestra** appears to be a counter-example to the earlier claim that individual-level nominals (ILNs) do not license specific complements, hence, ILNs can be expected to appear with a complement indicating membership in a particular group.

- **Instruments**

Busa argues that nominals denoting *instruments* are similar to individual-level nominals (ILNs) as the result of their lexical representation, and advocates the creation of a semantic distinction. Busa (1996: 116) argues that the behavior of **-er** nominals denoting instruments appears to have the same distribution as individual-level nominals (ILNs) denoting animal agents, in that frequency adjectives are not licensed and complements are either bare plural phrases, or compound modifiers:

235. (a) distributor of candles / *of the candy (i.e. candy machine).
 (b) professor of literature / of the poem / lliterature
236. (a) can opener / bottle opener
 (b) brick mason

Busa explains that the generalisation that is usually adopted is that the morpheme **-er** applies to an external argument which is interpreted as the agent of the event, irrespective of whether the type of that argument is human or physical_object. Busa refers to Sproat (1985) who argues that instruments should be treated as “lexical idioms”, since he observes a lack of systematicity in the argument role that **-er** picks out. She considers the noun **respirator**, which does not correspond to the ACTOR role of the verb *respirate*, but denotes a machine that aids to *respirate*. Similarly, the instrument *propeller*, in (237a) is not related to *ship*, in the same way **writer** is related to *book*:

237. (a) the propeller of the ship:
 (b) the writer of the book:

Busa (1996: 117) points out that the difference that Sproat notices in regard to the above, is that **book** corresponds to the THEME of *write*, while *ship* cannot be the THEME of *propel* since it is the possessor of the *propeller*. Busa cites Dowty (1991) arguing that this is insufficient evidence to say that *instruments* are lexical idioms, since the problems noticed by Sproat seem to be derived from the inadequacy of the theta-roles to fully capture fine-grained semantic distinctions between argument types.

Busa scrutinizes the defining properties for a noun to be considered as denoting an instrument, by pointing out that some of the properties of a noun are crucially part of its semantic type. Busa (1996: 118) claims that nominals such as **knife**, **chair**, **can opener**, **coffee grinder**, and **propeller** on their own appear to be rather odd, and they do not share the grammatical behavior of instruments. She considers the examples in (238)-(240) below.

238. (a) The knife / coffee grinder is on the second shelf.
 (b) !!The inducer / elicitor / conserver is on the second shelf.
239. (a) A knife is an instrument for cutting.
 (b) A conserver is an instrument for conserving.
240. (a) John opened the can with a good knife.
 (b) !John conserved the oil with a good conserver.

Busa (1996: 119) suggests that the nominals **conserver** or **inducer** should best be treated on the par of other nouns which Rappaport and Levin classify as non-agentive abstract nouns, such as those in (241) below.

241. (a) Anger is a great *defuser* of pent-up emotions.
 (b) Powerful emotions are certain *levellers* of ordinary feelings.

Busa maintains that the functionality of the object plays a crucial role for artifacts, but not for natural kinds, as is shown in (242) below:

242. (a) !a good rock:
 (b) a good chair:

Busa (1996: 120) specifies that a good chair is one that is comfortable to sit on, but it is not clear what a good rock is, unless the expression is uttered by a climber for whom a rock acquires a very specific functionality, i.e., climb on. She maintains that in Generative Lexicon the functionality is specified in the TELIC role, which is defined for all nouns whose type is *artifact-tool*:

243. $\left[\begin{array}{l} \text{artifact-tool} \\ \\ \text{ARGSTR} = [\text{ARG 1} = x: \text{phy-obj}] \\ \text{EVENSTR} = [\quad] \\ \\ \text{QUALIA} = \left[\begin{array}{l} \text{FORMAL} \\ \text{TELIC} = R(e_2, x) \\ \text{AGENTIVE} = \text{make}(e^r, z, : \text{human}, x) \end{array} \right] \end{array} \right]$

Busa asserts that the artifactual-tool indicated in (243) above specifies that the object has been created for a certain purpose that is left underspecified. She provides that an instrument such as **knife** is a subtype of the artifactual-tool, with its *TELIC* role specified:

244. $\left[\begin{array}{l} \text{knife} \\ \text{ARGSTR} = [\text{ARG 1} = x: \text{artifact-tool}] \\ \text{EVENSTR} = [\quad] \\ \\ \text{QUALIA} = \left[\begin{array}{l} \text{FORMAL} = x \\ \text{TELIC} = \text{cut}(e_2, x, y: \text{stuff}) \\ \text{AGENTIVE} = \text{make}(e^r, z, : \text{human}, x) \end{array} \right] \end{array} \right]$

She considers the representation of **knife** results in a complex structure of the *TELIC* as shown in (245):

245. $\left[\begin{array}{l} \text{knife} \\ \text{ARGSTR} = [\text{ARG 1} = x: \text{artifact-tool}] \\ \text{EVENSTR} = [\quad] \\ \\ \text{QUALIA} = \left[\begin{array}{l} \text{FORMAL} = x \\ \text{TELIC} = \left[\begin{array}{l} \text{TELIC} = \text{cut}(e_2, x, y: \text{stuff}) \\ \text{AGENTIVE} = \exists w [\text{use}(e_3, w, x)] \end{array} \right] \\ \text{AGENTIVE} = \exists z (\text{make}(e^r, z, : \text{human}, x) \end{array} \right] \end{array} \right]$

Busa (1996: 121) suggests that the relation in the *AGENTIVE* role embedded in the *TELIC* can be viewed as the antecedent of a conditional expression stating that for every cutting event there is some individual using that knife. She further argues that the derivation of instruments should be treated as encoding a complex relation, in that the mapping from the event description of which the **-er** nominal is a nominalization is filtered through the representation of *artifact_tools*. She considers the event description in (246) below, where the derivation is more explicit.

246. EVENT DESCRIPTION

$$\left[\begin{array}{l} \alpha \\ \text{ARGSTR} = \left[\begin{array}{l} \text{ARG 1} = x:\text{human} \\ \text{ARG 2} = y:\text{phys_obj} \\ \text{ARG 3} = z:\text{artifact_tool} \end{array} \right] \\ \text{QUALIA} = \left[\begin{array}{l} Q_j = \exists (e, z, y) \\ Q_i = \alpha (e, x, z) \end{array} \right] \end{array} \right]$$

Busa states that given the arguments types and the configuration between the subevents and arguments, there are potentially two different **-er** nominalizations: one corresponding to the external argument of the relation Q_j , (247), the other corresponding to the external argument of the relation Q_i .

247. EVENT DESCRIPTION

$$\left[\begin{array}{l} \text{-er} \\ \text{ARGSTR} = \left[\begin{array}{l} \text{ARG 1} = x:\text{human} \\ \text{ARG 2} = y:\text{phys_obj} \\ \text{ARG 3} = z:\text{artifact_tool} \end{array} \right] \\ \text{QUALIA} = \left[\begin{array}{l} \text{FORMAL} = z \\ \text{TELIC} = \left[\begin{array}{l} Q_j = \exists (e, z, y) \\ Q_i = \alpha (e, x, z) \end{array} \right] \\ \text{AGENTIVE} = \text{inherit (artifact)} \end{array} \right] \end{array} \right]$$

Busa mentions that this view also accounts for the fact that not all verbal forms license an **-er** noun denoting an instrument. Busa (1996: 122) refers to Rappaport and Levin (1992) who argued that verbal forms that do not have an intermediary instrument such as **smoker**, **drinker**, **eater** etc., do not license an instrument interpretation of the agentive noun. Busa asserts that the semantics of **-er** nouns can either be defined by a multiple listing of features, or in terms of its compositional properties.

Busa suggests that since the relation between the derived nominal and the event description is “filtered” through the semantic type of artifacts, the derivation of instruments should be

similar to V^1 nominalization, as opposed to the V^0 nominalizations associated with **smoker** or **drinker**. Busa claims that this explains why, with instruments, complements are generally not licensed except within noun-noun compounds. It is on this basis that Busa argues that the argument is a compound modifier rather than an NP complement:

248. (a) distributor of gas (gas station)
 (b) distributor of candy (a candy machine)

Busa specifies that evidence for the claim that the expression in (248) should be treated as compounds is provided by the fact that the modifier cannot be further modified by adjectives. Consider how the representation of the noun **propeller** follows precisely from it being an *artifact_tool* with a specific purpose:

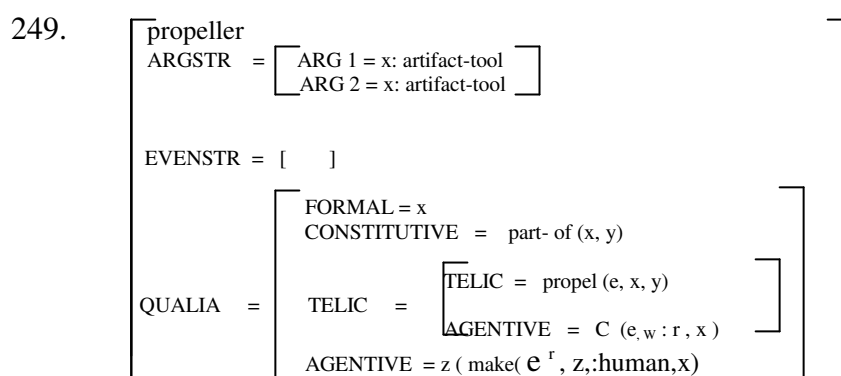

Busa (1996: 123) mentions that the **-er** nouns denoting instrument and the individual-level nominals (ILNs) share a similar representation, namely, the defining event is encoded in the *TELIC* role. She further argues that the instruments are not properly agentive nouns and claims that the ontological status of the two nominal types is crucially different.

3.5.2.2 Distinctions within the set of stage-level nominals

Busa argues that SLNs constrain the interpretation of the matrix verb, and as such are transparent in terms of temporal reference, connection could only be found with the tense system. This is true with nominals such as **widow** and **fugitive** (i.e. past) as in (250): **murderer** and **winner** (i.e. perfect) as in (19): **candidate** and **initiate** i.e. future) as in (23):

250. (a) Richard married a widow
 (b) The fugitive / escaped has not yet been found.
 (c) !Richard married his future widow. (N. Asher. p.c.)
 (d) !The fugitive is in jail.
 (cf. The fugitive is now in jail.)
251. (a) The winner of the Oceans marathon, had crossed the finish line
 when it started to rain.
 (b) !The winner of the Oceans marathon, had crossed the finish line
 when it, was called off.
252. (a) The candidate gave a very good speech.
 (b) !The candidate is in office.

Busa (1996: 26) explains that the nominal **widow** and **fugitive** denote individuals for which the defining event has occurred in the past and the resulting state holds at the time of reference, and that the noun **winner** requires that the event is fully completed, as is illustrated by the quaintness of (212b). She further contends that the noun **candidate** cannot refer to the individual once that individual is elected, and that the set of SLNs are also a class that is not fully homogenous. She considers the examples in (253) below.

253. (a) frequent passenger / pedestrian
 (b) frequent winner / author
 (c) !frequent widow / escapee
 (d) !frequent believer / connoisseur

Busa suggests that the various relations that the event defining a SLN establishes with the matrix predicate, correspond to a *present*, *past*, *perfect* and *future* event reading.

- **Stage-level agentive nominals**

Busa presents an analysis for the class of agentive nominals which can be characterized as stage-level since their defining event does not make reference to a persistent property of the individual. Busa (1996:125) points out that stage-level nominals assert the occurrence of the

particular event of which the individual is the agent. She further states that this property has grammatical consequences as it affects the way in which the nominal is interpreted relative to the event in the matrix clause i.e. there is a temporal overlap between the event defining the individual and the event expressed by the verb:

254. (a) The pedestrian on the crosswalk is limping.
 (b) The passenger felt sick.
255. (a) The pedestrian is sitting outside the South Street Café.
 (b) The pedestrian that you ran over yesterday is sitting outside the South Street Café.

Busa (1996:126) explains sentences in (254) as “the individual is limping while walking” and “the individual felt sick while traveling aboard some vehicle. Sentence (255a) is regarded as odd, by Busa, as it asserts that the individual is involved in two events of which he cannot be the agent at the same time, viz: **walking** and **sitting**. Busa (1996) points out that if the time of walking event is shifted relative to another event which is compatible with it as in (255b) then the sentence becomes acceptable.

Busa (1996) cites Pustejovsky (1995) argument that stage-level predicates differ from individual-level predicate in that the former can be viewed as artifactual predicates. This implies that the state which is predicated of an individual is causally related to an event which has a default status in the representation of the predicate, i.e. it is existentially closed. The causal content of the semantics of *stage-level predicates* ought to capture how the state of an individual is changeable and thereby attaching causative adjuncts:

256. Joseph is angry from reading the newspaper.

Busa points out that the final state is causally dependent on an experiencing relation as is illustrated in (257).

257. STAGE-LEVEL PREDICATE

$$\left[\begin{array}{l} \text{angry} \\ \text{ARGSTR} = \text{ARG 1} = x : \text{human} \\ \\ \text{EVENTSTR} = \left[\begin{array}{l} \text{E 1} = e_1 : \text{state} \\ \text{D-E 1} = e_2 : \text{process} \\ \text{RESTR} = e_2 < e_1 \\ \text{HEAD} = e_1 \end{array} \right] \\ \\ \text{QUALIA} = \left[\begin{array}{l} \text{FORMAL} = \text{angry} (e_1, x) \\ \text{AGENTIVE} = \text{exp_act} (e_2, x) \end{array} \right] \end{array} \right]$$

Busa (1996:133) states that in Pustejovsky (1995) it is also argued that stage-level nominals (SLNs) such as **pedestrian** or **passenger** involve a similar representation with the difference that the FORMAL role denotes a human individual and the AGENTIVE role denotes the event which characterizes that individual.

258. STAGE-LEVEL NOMINAL

$$\left[\begin{array}{l} X \\ \text{ARGSTR} = \text{ARG 1} = x : \text{human} \\ \text{EVENTSTR} = \text{D-E 1} = e : r \\ \\ \text{QUALIA} = \left[\begin{array}{l} \text{FORMAL} = X \\ \text{AGENTIVE} = R (e, x) \end{array} \right] \end{array} \right]$$

Busa (1996:134) states that an adequate description of the semantic contribution and the syntactic behaviour of SLNs can only be achieved by accounting for two crucial facts:

- (i) a SLN describes an individual in action
- (ii) a SLN imposes restrictions on the relation that ought to be established with the matrix verb.

- **Stagel-level nominals (SLNs) as complex types**

Busa (1996:137) argues that the nature of the underlying type of SLNs in light of one fundamental assumption in the generative lexicon (GL) namely the semantic type of a noun responsible for its grammatical behavior. She states that grammatical behavior is taken as

evidence for the meaning components which are encoded in the lexical entry. Consider the following examples:

259. (a) John walked in from the wooden door. (*aperture phy_object*)
 (b) !John walked in from the wooden entrance. (*aperture*)

She mentions that the predicate **walk in** selects for an object which is an aperture, while **wooden** specifies the constitution of a physical object. Busa (1996) makes reference to Pustejovsky's (1995, 1997) who points out that a variety of complex semantic types, i.e. dot objects, which are used in the system to capture the type of polysemies that are observed with nouns such as **door**, **book**, **construction** etc. The lexical entry for **door** is illustrated below.

$$260. \quad \left[\begin{array}{l} \text{door} \\ \text{ARGSTR} = \left[\begin{array}{l} \text{ARG 1} = x : \text{aperture} \\ \text{ARG 2} = y : \text{physical_object} \end{array} \right] \\ \text{QUALIA} = [\text{FORMAL} = \text{hold}(x,y)] \end{array} \right]$$

Busa states that the availability of an explicit relation R determines the range of syntactic expressions available with the complex type. Thus, **door** patterns with nominals whose type is aperture (i.e. entrance), and nominals whose type is phy_object. (i.e. board):

261. (a) the door to the kitchen (*aperture. phys_object*)
 (b) the entrance to the kitchen (*aperture*)
 (c) !!the board to the kitchen (*phys_object*)
262. (a) the wooden door (*aperture. phys_object*)
 (b) !!wooden entrance (*aperture*)
 (c) wooden board (*phys_object*)

Busa (1996:138) is of the opinion that since a complex type is a structured relation, it can be represented in terms of its constitutive part. The complex type of noun **door** can be viewed in terms of conjunction of the two types as shown in (263).

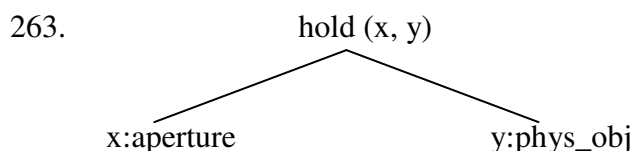

Busa (1996: 139) suggests that certain event nominals are also treated as dot object, a polysemous event noun such as **construction** for instance, the relation between the elements of the dot type is given by the precedence relation between subevents. She points out that under this view, **construction** is polysemous in three ways, namely process, result, and the reading in which both senses are available. She considers the examples in (264), from Pustejovsky (1995):

264. (a) The house's construction was finished in two months. (process)
 (b) The construction was interrupted during the rains. (process. result)
 (c) The construction is standing on the next street. (result)

Busa states that the nature of the relation holding between the types of the complex objects is the precedence relation between the subevents. Busa (1996: 140) contends that a nominal such as **passenger** appears to display the behavior of a complex type, and that a treatment in terms of dotted type is desirable since we do not need to restate the semantics of quantifiers, while treating these nouns as underlyingly relational. She regards stage-level nominals (SLNs) to be the complex type individual-event, where the event is not the defining event, i.e. **walk** for **pedestrian**, but rather the event on which the noun is predicatively dependent. She specifies that a predicative dependent relation is different from the relation that holds between the dotted types for a noun such as **door**. According to Busa, the complex relation is a constraint on the well-formedness of an expression applied to an individual involved in an event. She considers the structural representation of the relation of predicative dependence as shown in 265 below:

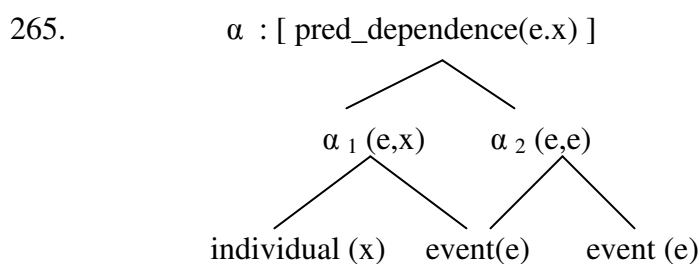

Busa (1996: 141) specifies that the structural representation in (265) above illustrates that the R_{PD} establishes a relation between an individual and an event as well as an additional relation between two events. She considers the lexical structure for **pedestrian** and **passenger** given in (266) - (267). below:

$$266. \left[\begin{array}{l} \text{pedestrian} \\ \text{ARGSTR} = \text{ARG 1} = \left[\begin{array}{l} \text{X: human} \\ \text{ARG 2} = \text{e: event} \end{array} \right] \\ \text{EVENTSTR} = \text{D-E 1} = \text{e} : \left[\begin{array}{l} \text{r} \\ \text{REST} = \text{in (e,e)} \end{array} \right] \\ \text{QUALIA} = \text{FORMAL} = \left[\begin{array}{l} \text{R}_{PD} (\text{e}, \text{x}) \\ \text{AGENTIVE} = \text{walk-on (e, x) } \wedge \text{on } (\cdot, \text{street}) \end{array} \right] \end{array} \right]$$

$$267. \left[\begin{array}{l} \text{passenger} \\ \text{ARGSTR} = \left[\begin{array}{l} \text{ARG 1} = \text{X: human} \\ \text{ARG 2} = \text{e: event} \\ \text{D- ARG 1} = \text{y: vehicle} \end{array} \right] \\ \text{EVENTSTR} = \left[\begin{array}{l} \text{D-E 1} = \text{e} : \text{r} \\ \text{REST} = \text{in (e,e)} \end{array} \right] \\ \text{QUALIA} = \left[\begin{array}{l} \text{FORMAL} = \text{R}_{PD} (\text{e}, \text{x}) \\ \text{AGENTIVE} = \text{travel-on (e, x, y)} \end{array} \right] \end{array} \right]$$

Busa outlines that the above entry also contain reference to the location of the event. i.e. **street** and **vehicle**, since **pedestrian**, for instance, only refers to individuals walking on a street but not on a trail. She is of the view that better predictions can be made, if rather than classifying the nouns in terms of aspectual properties associated with the event type, the classification is given in terms of grammatical properties associated with the verbal form, as is illustrated in (268) below.

268. (a) UNERGATIVE SLNs: e.g. pedestrian
 α -er if α -ing
- (b) UNACCUSATIVE SLNs: e.g. escape
 α -er if α -ed

- (c) CAUSATIVE SLNs: e.g. murderer
 α -er if have (α -ed)
- (d) INTENSIONAL SLNs: e.g. candidate
 α -er if will- α

Busa (1996: 156) distinguishes two types of agentive nouns which are associated with an underlying event description that denotes transition: *Unaccusative-SLN* and *Perfect-SLNs*, and they are interpreted differently. She indicates that the agentive nominals derived from event denoting activity, or a left-headed transition are associated with the affix **-er**. Conversely, the nominalization of right-headed transitions appears to be associated with the affix **-ee**. She considers the representations in (269) and (270), which reflect two different causal relations which correspond to different configurations of subevents and arguments:

269. CAUSATIVE LEFT-HEADED TRANSITIONS

$$(a) \left[\begin{array}{l} \alpha \\ \text{QUALIA} = \left[\begin{array}{l} \text{FORMAL} = \alpha_{\text{result}}(e_2, y) \\ \text{AGENTIVE}^* = \alpha_{\text{act}}(e_1, x, y) \end{array} \right] \end{array} \right] \Rightarrow \text{CAUSATIVE -SLN} \\ \textit{murderer, author}$$

$$(b) \left[\begin{array}{l} \alpha \\ \text{QUALIA} = \left[\begin{array}{l} \text{FORMAL} = \alpha_{\text{result}}(e_2, y) \\ \text{AGENTIVE}^* = \alpha_{\text{act}}(e_1, x, y) \end{array} \right] \end{array} \right] \Rightarrow \text{CAUSATIVE -SLN} \\ \textit{winner, discoverer}$$

270. CAUSATIVE RIGHT-HEADED TRANSITIONS

$$(a) \left[\begin{array}{l} \alpha \\ \text{QUALIA} = \left[\begin{array}{l} \text{FORMAL}^* = \alpha_{\text{result}}(e_2, y) \\ \text{AGENTIVE} = \alpha_{\text{act}}(e_1, x, y) \end{array} \right] \end{array} \right] \Rightarrow \text{UNACCUSATIVE-SLN} \\ \textit{widow, dead}$$

$$(b) \left[\begin{array}{l} \alpha \\ \text{QUALIA} = \left[\begin{array}{l} \text{FORMAL}^* = \alpha_result(e_2, y) \\ \text{AGENTIVE} = \alpha_act(e_1, x, y) \end{array} \right] \end{array} \right] \Rightarrow \text{UNACCUSATIVE-SLN} \\ \textit{fugitive, escape}$$

Busa (1996: 159) states that headless event structures license both causative and unaccusable nouns. She indicates that there is a very clear parallel which can be drawn with the event nominalization **escape**, which is polysemous between a process and a result reading, as is shown in (271).

271. (a) The evasione took place at midnight. (process)
 (b) The investigators did not find evidence of evasion. (result)

Busa indicates the process versus result readings for the agentive nouns as in (272) below.

- 272 (a) the escapee evaded from the prison. (result)
 b. The tax evader was arrested. (process)

She points out that with the event nominal **escapee** there is a unique lexicalization for both the process and the result reading, with the agentive nominal there is a split lexicalization. This can be illustrated in (273) below.

273.

$$(a) \left[\begin{array}{l} \alpha \\ \text{FORMAL} = \alpha_result(e_2, y) \\ \text{AGENTIVE}^* = \alpha_act(e_1, x, y) \end{array} \right] \begin{array}{l} \longrightarrow \textit{escapee} \\ \longrightarrow \textit{evader} \end{array}$$

$$(b) \left[\begin{array}{l} \alpha \\ \text{FORMAL} = \alpha_result(e_2, y) \\ \text{AGENTIVE}^* = \alpha_act(e_1, x, y) \end{array} \right] \begin{array}{l} \searrow \\ \nearrow \end{array} \textit{escape}$$

Busa argues that the nominal **escapee** refers to an individual for which the headed FORMAL role asserts a resulting state. The nominal **evader** corresponds to a nominalization of the AGENTIVE role of the event description. Busa (1996:160) is of the view that in order to capture the semantic relatedness of different stage-level nominals (SLNs) a configurational view of sub-events and arguments in an event structure representation provide the necessary tools. She points out that given the anaphoric properties of the defining event, the interpretation of the matrix verb is crucially dependent on the type of the defining event, the interpretation of the matrix verb is crucially dependent on the type of the event which characterizes a stage-level nominals (SLN).

- **Unaccusative Stage-Level Nominals**

It is stated that Unaccusative-SLNs display a behaviour which is parallel to that of unaccusative verbs. Busa (1996: 161) argues that the properties associated with the set of Unaccusative –SLNs can be explained in terms of right-headedness of the defining event. She maintains that the nominals **fugitive** and **escape** refer to an individual for which the stage – level property of not being captive results from an act of escaping. She considers the sentences in (154) below.

274. (a) At night , they check cars for *fugitives*.
- (b) The glitzy office that Ivan vacated for a prison cell had previously contained commodity operators Marc and Pinky, today *fugitives* from a potential century apiece of jail sentences.
- (c) First-hand accounts from Rangoon, later corroborated by escapees at the Thai border [...].

Busa explains that in the above examples, the matrix predicated is consistently interpreted as occurring within the interval in which the stage-level property of being free holds, i.e., the event which holds at the time of reference is the head of the event structure representation. She considers the lexical representation of the predicate **escape** in (275).

275.

escape	=	ARG 1 = X: human D- ARG 1= y: prison
EVENTSTR	=	E 1 = e ₁ : process E2 = e ₂ : state HEAD= e ₂ REST = e ₁ < α e ₂
QUALIA	=	FORMAL = captive (e ₂ , x) AGENTIVE = escape -act (e ₁ , x, y)

Busa (1996: 162) maintains that the headed property of the final state of the event description **escape** determines the way the situated property of the individual which refers to the resulting headed state is interpreted. She argues that with predicates denoting right-headed transitions, it is the headed final state which is going to be explicitly related to the matrix predicate. She proposes that the lexical representation for a noun such as fugitive can be represented as in (276) below.

276.

fugitive	=	ARG 1 = X: human D- ARG 1= y: prison			
EVENTSTR	=	E 1 = e ₁ : process E2 = e ₂ : state HEAD= e ₂ REST = e ₁ < α e ₂			
QUALIA	=	FORMAL = R (e, x) AGENTIVE = <table style="border-collapse: collapse; margin-left: 20px;"> <tr> <td style="border-right: 1px solid black; padding-right: 5px;">AGENTIVE</td> <td style="padding: 0 5px;">=</td> <td style="border: 1px solid black; padding: 2px;"> FORMAL = captive (e₂, x) AGENTIVE = escape -act (e₁, x, y) </td> </tr> </table>	AGENTIVE	=	FORMAL = captive (e ₂ , x) AGENTIVE = escape -act (e ₁ , x, y)
AGENTIVE	=	FORMAL = captive (e ₂ , x) AGENTIVE = escape -act (e ₁ , x, y)			

- **Causative stage-level nominals**

Busa examines causative stage-level nominals (SLNs) by first juxtaposing them with the Unaccusative – stage-level nominals (SLNs), whose matrix predicate is related to the defining event via the relation *in*. Busa contends that nominals such as, **discoverer** and **murderer** denote an individual who has discovered something and an individual who has murdered someone, respectively. The fundamental aspect denoted by these two nominals is that, both events have culminated, and have been performed by an individual. Busa argues that with nominal **fugitive**, the outcome of the event does not affect the individual, rather, the defining event occurs after the matrix event. She maintains that one of the fundamental properties of Causative- SLNs is that the event has to have occurred and be completed, as is illustrated in the examples in (277) – (278).

277. (a) The winner of the Boston marathon crossed the finish line when it began to rain.
- (b) Two runners of the Boston marathon crossed the finish line when it began to rain.
278. (a) !The winner of the Boston marathon, had crossed the finish line when it was called off.
- (b) Two runners of the Boston marathon, had crossed the finish line when it was called off.

Busa argues that the different behavior of **winner** and **runner** in (277) can be explained by the fact that a Causative-SLN such as **winner** requires the completion of the event, and hence that the competition be completed. She examines the Causative-SLNs under a future or irrealis reading as well. She points out that the crucial property of this class of nouns is that the event has culminated, as is illustrated in the semantically odd sentences in (279).

279. (a) The writer of this book, hopes to finish it, tomorrow.
- (b) !The murderer of Mary, will kill her, tonight.

Busa (1996: 170) suggests that in terms of the presupposition, if *x* is a murderer, then *x* has to have murdered, and will always be the murderer. Similarly, if *x* is the author of *y*, then *y* has

to be finished. She states that these nominals appear to have a reading that parallels the behavior of perfect tense.

Busa refers to Parsons (1990) who argues that the perfect introduces a culminative state resulting from having performed that event, and this state is interpreted to hold forever, and is called the *resultant state*. Busa refers to Pustejovsky (1996) who also argues that the perfect adds additional structure to the event type.

Busa (1996: 171) contends that the crucial property licensing agentive nominals from a headed event structure is that the headed event contains the external argument. Reference is made to the initial sub-event by the perfect reading, and this results in a progressive reading, i.e. the x who is **murdering**. She considers the representation of the nominal **murderer** in (280).

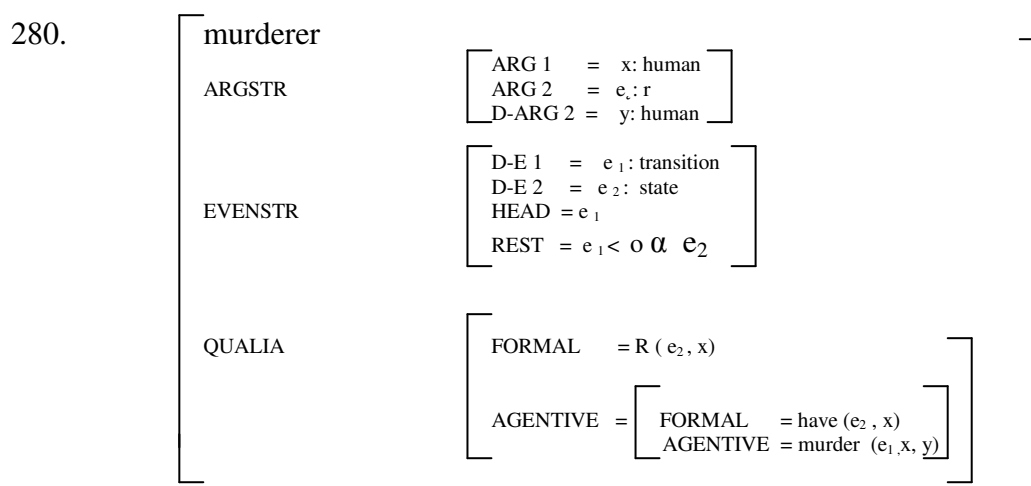

She points out that in the case of intensional SLNs the defining event is included in the initial process, and no information about the occurrence of the final state is given. She considers the representation for the nominal **candidate** in (281).

281.

	candidate	
ARGSTR =	ARG 1 = x: human ARG 2 = e _i :r	
EVENTSTR =	D - E 1 = e ₁ : process D - E 1 = e ₂ : state REST = e ₁ < α e ₂ ^ in (e<, e ₁)	
QUALIA =	FORMAL = R (e, x) TELIC = elected (e, x) AGENTIVE = candidate-act (e ₁ , x)	

Busa (1996: 174) states that the culminating state in (281) is encoded in the *TELIC* role, given that the possible resulting state is interpreted as a purpose of the individual, and there is no assertion about the occurrence of the event. She maintains that the stage-level versus the individual-level distinction emerge very clearly from the qualia structure representation of a noun.

3.6 CONCLUSION

In conclusion, Pustejovsky has argued that the classification of verbs into semantically unique classes does not necessarily provide a solution in regard to the meaning of words. The verbal alternations of certain verbs are not able to sufficiently determine their semantic class, particularly, in circumstances where these verbs have both a transitive and an intransitive form. The modification of verbs by temporal and point adverbials assisted in determining reference to an explicit change of state. The presence of bare plural marker played a critical role in terms of determining the meaning of verbs, as it tended to shift the meaning of verbs from an activity to accomplishment. In nominal alternations relations (i.e., horizontal or hierarchical), played an important role in determining the meaning of lexical items. Adjective classes tended to behave in a similar manner like verbs in regard to complementation patterns. The five classes of lexical items also helped in determining the meaning of lexical items.

In section 3.3 the interaction of the different levels of lexical representations, such as the event structure, and qualia structure illustrated the importance of looking at both the syntactic

and semantic contexts in determining the qualia values of lexical expressions. The inadequacy of the inheritance system in being unable to capture the different dimensions of meaning for lexical items has led to the introduction of typed inheritance, as this assisted in indicating the type of inheritance in argument and qualia relations.

The application of coercion has helped in shaping the meaning of lexical items by reconstructing the semantics of the complements to be realized as gerundive or infinitival phrases, thereby, denoting an event reading. This chapter has also dealt with the generative lexicon views on composition, particularly, its importance in determining the senses of the predicate as it composes with other complements in a sentence. The difference in how sentences and NPs differ in showing event denotation has been examined, and also the importance of tensing of an events selecting predicate so as to indicate propositional information. The only limitation is that, the relation between events and propositions, together with the consequences to the analysis of tense as a generalized quantifier, has not received any attention within the generative lexicon.

In the semantics of nominals, the varieties of nominalization enhanced the interpretation of polysemous lexical items juxtaposed with nominals that seem unable to behave polysemously. The issue of split lexicalization in nouns such as **sale**, **purchase** and **transaction** showed the different interpretations denoted by these nominals. In looking at the qualia of pronouns in regard to referential transparency, it became evident that pronouns such as, **she**, **himself** and **it**, are lexically devoid of relational information. Nouns such as **baker**, **lecturer**, and **bread** have been found to be referentially transparent.

In section 3.5, Busa has argued that the crucial property of Individual-level nominals (ILNs) is that the individual defined as α – er need not be engaged in an activity at the time of reference. It has been shown by Busa that there is a need for tools to characterize the compositional processes for deriving the different interpretations of the ILNs where they display a variety of meanings in different contexts. The fundamental issue dealt with in the Stage-level nominals (SLNs) relate to the notion that SLNs assert the occurrence of a particular event of which the individual is the agent.

CHAPTER 4

A SYSTEMATIC INVESTIGATION OF DEVERBAL NOMINALS

4.1 INTRODUCTION

In chapter 4, the main aim and purpose is the systematic classification of deverbal nominals that are derived from various semantic verb classes and are considered under their derivation from intransitive, transitive and di-transitive verbs, respectively. This chapter is organised as follows: Section 4.1 is the general introduction detailing the general contents of this chapter. Section 4.2 contains the various sub-areas of the deverbatives which are considered under intransitive verb classes. The various sub-sections in this chapter present two lexical schematic representation for each verb class, such as state verbs, motion verbs, verbs relating to the body, experiencer verbs, weather verbs and motion verbs with a locative argument.

The first lexical schematic representation for each verb class gives a classification of various deverbal noun classes 1, 3, 5, 7, 8, 9, 11 and 14 in instances where the noun class applies. The second schematic representation details how these various verb classes are classified / categorized in terms of their semantic type. In section 4.3 the various sub-areas of the deverbatives are considered under transitive verb classes. Section 4.4 presents deverbatives that have been derived from change of possession verb class. Section 4.5 concludes the chapter.

4.2 INTRANSITIVE VERBS

4.2.1 State verbs

Levin (1993:243) cites Hale and Keyser (1987) in describing state verbs as verbs that refer to action that brings about change in the material integrity of some entity. The lexical schematic representation below presents various deverbal noun classes 1, 3, 5, 7, 8, 9, 11 and 14 that are derived from various intransitive state verbs.

	Class 1	class 3	class 5	class 7	class 8	class 9	class 11	class 14
lamba	umlambi	umlambo	ilamba	isilambi	izilambi		ulambo	ubulambo
godola	umgodoli			isigodoli	izigodoli	ingodoli		
khuthala	umkhuthali			isikhuthali	izikhuthali	inkuthalo		
tyeba			ityeba	isityebi	izityebi			
bhitya			ibhityo					
luphala	umluphali		iluphala	isiluphali	iziluphali			
bola	umboli			isiboli	iziboli		ubolo	ububolo
phakama	umphakami			isiphakami	iziphakami	impakamo	uphakamo	
thula	umthuli			isithuli	izithuli	intulo	uthulo	

In the lexical schematic representation below the various sub-areas of the deverbatives derived from various intransitive state verbs are classified in terms of semantic type, such as Person, Inchoative state, State, Feelings, Result and Quality. The categorization of each deverbal nominal class is specified by means of a binary feature (+) in the various semantic types.

Class	lamba	godola	khuthala	tyeba	bhitya	luphala	bola	phakama	thula
Person									
1									
5	+			+	+	+		+	
7	+	+	+	+		+	+	+	+
8	+	+	+	+		+	+	+	+
9		+					+		+
Inchoative state									
9								+	
State									
9			+						+
Feelings									
9								+	
Result									
11	+						+	+	+
Quality									
14	+						+		

Nominalisation of state verbs:**lamba** (be hungry)

A. [Person]:

Class 1: umlambi (hungry man)

1. (a) Umlambi uyakhalaza.
(The hungry man is complaining)
- (b) Umlambi ulele.
(The hungry man is asleep).

lamba (be hungry)

B. [Manner]:

Class 3: umlambo (manner of hunger)

2. (a) Umlambo wakhalisa abantwana.
(The hunger made the children cry).
- (b) Umlambo uyabothusa abantu.
(The hunger scares the people).

lamba (be hungry)

C. [Person]:

Class 5: ilamba (hungry person)

3. (a) Ilamba lacela ukutya ebantwini.
(The poor man asked for food from the people).
- (b) Ilamba lomfo laphiwa ukutya.
(A poor man was given food).
- (c) Ilamba labafo lalala lingatyanga.
(The group of poor men slept without eating).

Class 7: isilambi (a hungry person)

4. (a) Isilambi saphiwa ukutya.
(The hungry person was given food).
- (b) Isilambi sendoda silele.
(The hungry man is asleep).
- (c) Isilambi samadoda sahamba.
(The group of hungry men left).

Class 8: izilambi (hungry men)

5. (a) Izilambi zakhutshelwa ngaphandle kobuhlanti.
(The hungry men were chased out of the kraal).
(b) Izilambi zaphiwa izonka kuphela.
(The hungry men were given only bread).

lamba (hungry)

D. [Result]:

Class 11: ulambo (hunger)

6. (a) Ulambo lubakhokelele kubundlobongela.
(The hunger led them to criminality).
(b) Ulambo lwabangela izifo.
(The hunger causes diseases).

lamba (hungry)

E. [Quality]:

Class 14: ubulambo (quality of hunger)

7. (a) Ubulambo babulala imfuyo.
(The quality hunger killed livestock).
(b) Ubulambo banaba esixekweni.
(The quality hunger spread in the village).

The deverbatives derived from the state verb **lamba** can be found in almost all the specified noun classes except for noun class 9. The lexical semantic type interpretation for the deverbal nominals derived from noun classes 1, 5, 7/8 denotes person and for noun classes 11 and 14, they denote result and quality, respectively. In noun class 3 they denote feelings.

khuthala (diligent, industrious, meticulous)

A. [Person]:

Class 1: umkhuthali (diligent person)

1. (a) Umkhuthali usebenza kakuhle namhlanje.
(The diligent person is working well today).
(b) Umkhuthali udiniwe.
(The diligent man is tired).

khuthala (diligent, industrious, meticulous)

B. [Person]:

Class 7: isikhuthali (diligent person)

2. (a) Isikhuthali satyala iintyatyambo egadini.
(A diligent person ploughed flowers in the garden).
- (b) Isikhuthali sendoda sakha indlu.
(A diligent man built a house).
- (c) Isikhuthali samadoda sacula ingoma.
(The group of diligent men sang a song).

khuthala (diligent, industrious, meticulous)

C. [Person]:

Class 8: izikhuthali (diligent men)

3. (a) Izikhuthali zasebenza imini yonke.
(Diligent persons worked the whole day).
- (b) Izikhuthali zamadoda zaphunyuzwa ngumphathi.
(Diligent groups of men were rested by the manager).

khuthala (diligent, industrious, meticulous)

D. [State]:

Class 9: inkuthalo (state / act of being diligent / industrious / meticulous)

4. (a) Inkuthalo yabadlali yabenza baphumelela umdlalo
(The industriousness of players made them to win the match).
- (b) Inkuthalo emsebenzini yamenza wonyuselwa.
(Industriousness at work made him to be promoted).

The deverbatives derived from the state verb **khuthala** can be found in noun classes 1, 7/8 and noun class 9. The lexical semantic type interpretation for the deverbal nominals derived from noun classes 1 and 7/8 denotes person and for noun class 9 denotes a state interpretation. The state verb **khuthala** cannot form deverbal nominals for the noun classes 3, 5, 11 and 14, respectively.

tyeba (fat / rich)

A. [Person]:

Class 5: ityeba (rich / fat man)

1. (a) Ityeba zange likwazi ukungena emotweni.
(The fat person could not enter in the car).
- (b) Ityeba lendoda lathenge iifama ezimbini.
(The rich man bought two farms).
- (c) Ityeba lamadoda lakha isikolo.
(The group of rich men built a school).

tyeba (rich, fat)

B. [Person]:

Class 7: isityebi (rich / fat person)

2. (a) Isityebi sale lali sibhubhile.
(The rich man of this village has died).
(The fat person of this village has died).
- (b) Isityebi sendoda sakha isikolo ekuhlaleni.
(The wealthy man built a school in the community).
- (c) Isityebi samadoda sathenga ukutya.
(The group of rich men bought food).

tyeba (rich, fat)

C. [Person]:

Class 8: izityebi (rich / wealthy / fat men)

3. (a) Izityebi zathenga ukutya.
(Rich men bought food).
(Fat men bought food).
- (b) Izityebi zamadoda zakha iholo.
(The groups of wealthy men built a community hall)
(The groups of fat men built a community hall).

bhitya (thin / lean)

A. [Person]:

Class 5: **ibhityo** (thin / lean / emaciated person)

1. (a) **Ibhityo loyisakala ukuphakamisa iingxowa emhlabeni.**
(The thin person failed in lifting heavy sacks from the ground).
- (b) **Ibhityo lomfo labulala ingonyama.**
(The thin man killed a lion).
- (c) **Ibhityo lamadoda layitya yonke inyama.**
(The group of emaciated men ate all the meat).

luphala (old)

A. [Person]:

Class 5: **iluphala** (old person)

1. (a) **Iluphala lathenga imoto edolophini.**
(The old person bought a car in town).
- (b) **Iluphala lendoda lahlaelwa zizihange.**
(The old man was attacked by thugs).
- (c) **Iluphala lamadoda lafumana izindlu.**
(The group of old men received houses).

luphala (old)

B. [Person]:

Class 7: **isiluphali** (old folk / man)

2. (a) **Isiluphali sanyuselwa inkamnkam ngurhulumente.**
(Old folk's pension was increased by the government).
- (b) **Isiluphali sendoda sazihlalela sodwa.**
(The old man stayed alone).
- (c) **Isiluphali samaxhego solula imizimba.**
(The group of old men folk stretched their bodies).

luphala (old)

C. [Event]:

Class 11:

3. (a) Uluphalo lwamgulisa umfazi.

(The way of growing old made the woman sick).

(b) Uluphalo lwamyekisa umsebenzi.

(The way of growing old made him to retire).

The deverbatives derived from the state verb **tyeba** can be found in noun classes 5 and 7/8, whereas the state verb **bhitya** can only be nominalised in class 5. The lexical semantic type interpretation for the deverbal nominals derived from noun classes 5 and 7/8 denotes person for both these state verbs **tyeba** and **bhitya**, and for noun class 9 **bhitya** denotes a state interpretation.

In summary, it is evident from the above lexical schematic representation of the state verb **lamba** that this verb can be nominalised in almost all the noun classes except for noun class 9 and that four of these noun classes 1, 5, 7/8 denote person. In noun class 3 the derived nominal **umlambo** denotes manner of hunger whereas in noun class 11 and 12 the derived nominals **ulambo** and **ubulambo** denote result and quality respectively. The deverbatives in noun class 1, 7/8 and 9 with the suffix-**i** denoting person have the interpretation of an individual-level nominals (ILNs). Sometimes in noun class 7 denoting person the interpretation may be that of a stage-level nominals (SLNs) depending on how the deverbal noun is used. The deverbatives in noun class 5 denoting person have an interpretation of a stage-level nominals (SLNs).

4.2.2 Motion verbs

Levin (1993 : 264) describes motion verbs as including a specification of direction of motion, even in the absence of an overt directional complement. The lexical schematic representation below demonstrates various deverbatives from the following noun classes 1, 3, 5, 7, 8, 9 and 11 that are derived from various intransitive motion verbs.

	Class 1	class 3	class 5	class 7	class 8	class 9	class 11
dada	umdadi	umdado		isidadi		indadi	udado
hamba	umhambi	umhambo	ihambi/ ihambo	isihambi	izihambi		uhambo
rhubuluza	umrhubuluzi	umrhubuluzo		isirhubuluzi	izirhubuluzi	inkrhubuluzi	urhubuluzo
qubha	umqubhi	umqubho		isiqubhi	iziqubhi	inkqubhi	uqubho
xhuma	umxhumi	umxhumo		isixhumi	izixhumi	inkxumo	uxhumo
shukuma	umshukumi	umshukumo		isishukumi	izishukumi	intshukumo	ushukumo

In the lexical schematic representation below the various sub-areas of the deverbatives derived from various intransitive motion verbs are classified in terms of semantic type, such as Person, Event, Action/Result and Cognition. The categorization of each deverbal nominal class is specified by means of a binary feature (+) for the various semantic types.

Class	dada	hamba	rhubuluza	qubha	xhuma	shukuma
Person						
1	+	+	+	+	+	+
5		+				
8		+	+	+	+	+
7	+	+	+	+	+	+
9	+		+	+		
Event						
3	+	+	+	+	+	+
5		+				
11	+	+	+	+	+	+
Action/ Result						
9					+	
Cognition						
7		+				
9					+	

hamba (go)

A. [Person]:

Class 1: umhambi (traveller)

1. (a) Umhambi wafika ebusuku.
(The traveller arrived at night).
- (b) Umhambi ufikile.
(The traveller has arrived).

hamba (go)

B. [Manner]

Class 3: umhambo (manner of travelling)

2. (a) Umhambo wadinisa abantu.
(The travelling made the people tired).
- (b) Umhambo waphazanyiswa yimvula.
(The travelling was delayed by raining).

hamba (go)

B. [Person]

Class 5: ihambi (habitual traveller / visitor)

2. (a) Ihambi lifike ngoMgqibelo.
(The traveller arrived on Saturday).
- (b) Ihambi lendoda layilungiselela ihambo.
(The travelling man prepared for the journey).
- (b) Ihambi lamadoda lakhwela uloliwe.
(The group of travelling men boarded the train).

hamba (go)

C. [Result]:

Class 5: ihambo (a walk, act of walking / travelling)

3. (a) Ihambo yathatyathwa sisikolo.
(The travelling was undertaken by the school).
- (b) Ihambo eya eMonti zange iphumelele.
(The travelling to East London did not materialise).

hamba (go)

D [Person]:

Class 7: isihambi (traveller)

4. (a) Isihambi sanduluka kusasa.
(The traveller left in the morning).
- (b) Isihambi sendoda sadibana nengozi.
(The travelling man came across an accident).
- (c) Isihambi samadoda sashiya impahla yaso.
(The group of travelling men left their clothes).

hamba (go)

E. [Person]:

Class 8: izihambi (travelling / visiting men)

5. (a) Izihambi zafika emva kwexesha.
(The visiting men arrived late).
- (b) Izihambi zamadoda zahlangana nenyoka.
(The travelling men came across a snake).

hamba (go)

F. [Event]:

Class 11: uhambo (way of travelling)

6. (a) Uhambo lwathatha imini yonke.
(The travelling took the whole day).
- (b) Uhambo lwadinisa abantwana.
(The travelling made the children tired).

The deverbatives derived from the motion verb **hamba** can be found in almost all the specified noun classes except for noun class 9. The lexical semantic type interpretation for the deverbal nominals derived from noun classes 1, 5, 7/8 denotes person. A different interpretation is derived for the deverbal nominal **ihambo** in noun class 5 as it denotes an event.

xhuma (jump)

A. [Person]:

Class 1: umxhumi (jumping person)

1. (a) Umxhumi watsiba ucingo.
(The jumper scaled over the fence).
- (b) Umxhumi waqhuba imoto
(The jumper drove the car)..

xhuma (jump)

B. [Manner]:

Class 3: umxhumo (manner of jumping)

2. (a) Umxhumo wamenza waphumelela kwezembaleki.
(The jumping amde him to win in athletics)

- (b) Umxhumo wamdinisa ngokukhawuleza.
(The jumping made him tired quickly).

xhuma (jump)

C. [Person]:

Class 7: isixhumi (jumper)

3. (a) Isixhumi saxhumela phezulu ukutsiba intambo.
(The jumper jumped high to scale the rope).
(b) Isixhumi senkwenkwe saqapheleka emapoliseni.
(The jumping boy was noticeable to the police).
(b) Isixhumi samadoda sabulala inyoka.
(The group of jumping men killed a snake).

xhuma (jump)

D. [Person]:

Class 8: izixhumi (jumpers, jumping men))

4. (a) Izixhumi zadlala umbhoxo.
(The jumpers played rugby).
(b) Izixhumi zabafo zathatha inkxaxheba kukhuphiswano.
(The jumping men participated in the competition).

xhuma (jump)

E. [Action, Result]:

Class 9: inkxumo (a jump / increase, jumping)

5. (a) Inkxumo yexabiso lombane iyakhwinisa.
(The increase in electricity tariffs is mind boggling).
(b) Inkxumo ayenzileyo imsindise ekugilweni yimoto.
(The jumping he made helped him from being hit by a car).

xhuma (jump)

F. [Cognition]:

Class 9: inkxumo (support)

6. (a) Inkxumo yabaxhasi yamkelekile kosomashishini.
(The support of the customers is welcomed by the business people).
- (b) Inkxumo kubathengi soloko ikho.
(The support from the shoppers is always there).

xhuma (jump)

G. [Action, Result]:

Class 11: uxhumo (jumping)

7. (a) Uxhumo lwemoto lubangele ingozi.
(The jumping of the car caused an accident).
- (b) Uxhumo lwexabiso lombane alwamkelekanga.
(The increase in electricity tariffs is not acceptable).

The deverbatives derived from the motion verb **xhuma** can be found in almost all the specified noun classes except for noun class 5. The lexical semantic type interpretation for the deverbal nominals derived from noun classes 1 and 7/8 denotes person.

In summary, it is clear from the above lexical semantic representation of the motion verbs **hamba** and **xhuma** that these verbs can be nominalised in almost all the noun classes except for noun class 9 and noun class 5 for both these motion verbs respectively. The lexical semantic type for the deverbal nominals derived from these two motion verbs have similar interpretations in the noun classes 1 and 7/8 as they denote person. This similarity is evident in noun class 3 and 11 as both deverbal nouns derived from these two motion verbs denote an event. The deverbatives in noun class 1, 7/8 and 9 have the interpretation of an individual-level nominals (ILNs). In noun class 7 denoting person the interpretation may be that of a stage-level nominals (SLNs) depending on how the deverbal noun is used. The deverbatives in noun class 5 denoting person have an interpretation of a stage-level nominals (SLNs).

4.2.3 Verbs relating to the body (Bodily processes)

Levin (1993 : 218) describes verbs relating to the body as verbs that relate to involuntary bodily processes. The lexical schematic representation below displays various deverbatives from the noun classes 1, 3, 5, 7, 8, 9 and 11 that are derived from various intransitive verbs relating to the body.

	class 1	class 3	class 5	class 7	class 8	class 9	class 11
khohlela	umkhohleli	umkhohlelo		isikhohlela	izikhohlela	inkohleli	ukhohlelo
thimla	umthimli	umthimlo		isithimli	izithimli	intimlo	uthimlo
gabha	umgabhi	umgabho		isigabhi	izigabhi	ingabho	ugabho
bhodla	umbhodli	umbhodlo		isibhodli	izibhodli	imbodli	ubhodlo
rhona	umrhoni	umrhono		isirhoni	izirhoni	inkroni	urhono
phefumla	umphefumli	umphefumlo				impefumlo	uphefumlo
ncwina	umncwini	umncwino		isincwini	izincwini	incwina	uncwino
lila	umlili		ilila	isililo	izililo		ulilo
bila	umbili	umbilo					ubilo
tsica	umtsici	umtsico		isitsici	izitsici	intsico	utsico
zamla	umzamli	umzamlo		isizamli	izizamli	inzamlo	uzamlo
qhwanyaza	umqhwanyazi	umqhwanyazo		isiqhwanyazi	iziqhwanyazi	inkqwanyazi	uqhwanyazo
suza	umsuzi	umsuzo		isisuzi	izisuzi	intsuzo	usuzo
dumzela	umdumzeli	umdumzelo		isidumzeli		indumzelo	udumzelo

dumba	umdumbi	umdumbo		isidumbi	izidumbi	indumbo	udumbo
gula	umguli	umgulo		Isiguli/ isigulo	iziguli	ingulo	ugulo
limala	umlimali			isilima	izilima		ulimalo
rhawuzela	umrhawuzeli	umrhawuzelo		isirhawuzeli	izirhawuzeli	inkrawuzelo	urhawuzelo
dangala	umdangali	umdangalo	idangala	isidangali	izidangali	indangalo	udangalo
qhwalela	umqhwaleli	umqhwalelo		isiqhwala	iziqhwala	inkqwalelo	uqhwalelo

In the lexical schematic representation below the various of the deverbatives derived from various intransitive verbs relating to the body are classified in terms of semantic type, such as Person, Event, Action/Result Result, Action, Manner of event, state and Feelings. The categorization of each deverbal nominal class is specified by means of a binary feature (+) for the various semantic types.

Class	dumba	gula	limala	rhawuzela	dangala	qhawalela
Person						
1	+	+	+	+	+	+
7	+	+	+	+	+	+
5					+	
8	+	+	+	+	+	+
State						
3	+	+	+	+	+	+
9	+	+			+	+
7		+				
Feelings						
9				+		
Result						
11		+				
Event						
11	+		+	+	+	+

khohlela (cough)

A. [Person]:

Class 1: umkhohleli (a coughing person)

1. (a) Umkhohleli wasweleka.
(The coughing person died).
- (b) Umkhohleli uhambile.
(The coughing person is gone).

khohlela (cough)

B. [Manner]:

Class 3: umkhohlelo (manner of coughing)

2. (a) Umkhohlelo wavusa abantwana.
(The manner of coughing woke up the children).
- (b) Umkhohlelo wanyangwa liyeza.
(The manner of coughing was treated with medication).

khohlela (cough)

C. [Person]:

Class 7: isikhohleli (coughing person)

3. (a) Isikhohleli sibonane nogqirha.
(The coughing person consulted with the doctor).

- (b) Isikhohleli sendoda silaliswe esibhedlele.
(The coughing man has been admitted in hospital).
- (c) Isikhohleli samadoda sizimele esibhedlele.
(A group of coughing men escaped from the hospital).
(The group of coughing men hid in the hospital).

khohlela (cough)

D. [Result]:

Class 7: isikhohlela (sputum, phlegm)

- 4. (a) Isikhohlela sixilongwe ngugqirha.
(The sputum has been examined by the doctor).
- (b) Isikhohlela kufanele silahlwe ngokufanelekileyo.
(The sputum ought to be disposed of appropriately).

Class 8: izikhohlela (sputum, phlegm)

- 5. (a) Izikhohlela zatshatyalaliswa sisibhedlela.
(The sputums were destroyed by the hospital).
- (b) Izikhohlela zagcinwa ezinkonkxeni.
(The sputums were stored in the tins).

khohlela (cough)

E. [Person]:

Class 9: inkohleli (a habitually coughing person)

- 6. (a) Inkohleli yayeka ukutshaya.
(The habitually coughing person stopped smoking).
- (b) Inkohleli yendoda yathunyelwa esibhedlele.
(The habitually coughing man was sent to hospital).
- (c) Iinkohleli zamadoda zawasela amayeza.
(The groups of habitually coughing men took their medication).

khohlela (cough)

F. [Event]:

Class 11: ukhohlelo (way of coughing)

- 7. (a) Ukhohlelo lwabantwana lwakhokelela ekuvalweni kwesikolo.

(The coughing of the children led to the closure of the school).

- (b) Ukhohlelo alunyangeki kwizilwanyana.
(The coughing is not curable in animals).

The deverbatives derived from the verb relating to the body **khohlela** can be found in almost all the specified noun classes except for noun class 5. The lexical semantic type interpretations for the deverbal nominals derived from noun classes 1, 5, 7/8 denote person. The deverbal nominals derived from the verbs relating to the body can be found in almost all the noun classes with some few exceptions in noun class 5 where a limited number of deverbal nouns are derived.

thimla (sneeze)

A. [Person]:

Class 1: umthimli (sneezing person)

1. (a) Umthimli zange aphangele.
(The sneezing person did not go to work).
- (b) Umthimli walala ebusuku.
(The sneezing person slept at night).

thimla (sneeze)

B. [Mannert]:

Class 3: umthimlo (manner of sneezing)

2. (a) Umthimlo wenzeka imini yonke.
(The sneezing happened the whole day).
- (b) Umthimlo wabangelwa ngumsi.
(The manner of sneezing was caused by the smoke).

thimla (sneeze)

C. [Person]:

Class 7: isithimli (sneezing person)

3. (a) Isithimli zange sikwazi ukuphangela.
(The sneezing person could not go to work).
- (b) Isithimli sendoda safuna uncedo kugqira
(The sneezing man looked for help from the doctor).

- (c) Isithimli samadoda sabonana nogqirha.
(The group of sneezing men consulted a doctor).

thimla (sneeze)

D. [Person]:

Class 8: izithimli (sneezing men)

4. (a) Izithimli zatya inyama.
(Sneezing men ate meat).
- (b) Izithimli zamadoda zalala kwigumbi elilodwa.
(The groups of sneezing men slept in a separate room).

thimla (sneeze)

E. [Result]:

Class 9: intimlo (sneezing)

5. (a) Intimlo ikhokelela kuvaleko lwempumlo.
(Sneezing leads to the blocking of noses).
- (b) Intimlo yabangela umkhuhlane.
(Sneezing resulted in fever).

thimla (sneeze)

F. [Event]:

Class 11: uthimlo (way of sneezing)

6. (a) Uthimlo lwasasaza intsholongwane yomkhuhlane.
(The way of sneezing spreads the fever bacteria).
- (b) Uthimlo lwanyangwa ngugqirha.
(The sneezing was treated by the doctor).

gabha (vomit)

A. [Person]:

Class 1: umgabhi (vomiting person)

1. (a) Umgabhi waphumela phandle.
(The vomiting person went outside).
- (b) Umgabhi waya kwagqirha.
(The vomiting person went to the doctor).

gabha (vomit)

B. [Manner],[Result]

Class 3: umgabho (manner of vomiting, vomit)

2. (a) Umgabho wagxotha abathengi evenkileni.
(The vomit chased away customers in the shop).
- (b) Umgabho wosulwa ngabasebenzi.
(The vomit was wiped by the workers).

gabha (vomit)

C. [Person]:

Class 7: isigabhi (vomiting person)

3. (a) Isigabhi sangcolisa impahla.
(A vomiting person dirtied the clothes).
- (b) Isigabhi sendoda savalelwa ngaphandle kwamasango.
(The vomiting man was closed outside the yard).
- (c) Isigabhi samadoda sahlamba impahla emdaka.
(The group of vomiting men washed dirty clothes).

gabha (vomit)

D. [Person]:

Class 8: izigabhi (vomiting persons)

4. (a) Izigabhi zabonana nogqirha.
(The vomiting persons consulted the doctor).
- (b) Izigabhi zamadoda zakhutshelwa ngaphandle.
(Vomiting men were taken outside).

gabha (vomit)

E. [Action]:

Class 9: ingabho (vomitting)

5. (a) Ingabho ayilawuleki ngamanye amaxesha.
(Vomitting is uncontrollable at times).
- (b) Ingabho ibangelwe kukutya okudala.
(Vomitting was caused by old food).

gabha (vomit)

F. [Result], [Event]

Class 11: ugabho (vomitting)

6. (a) Ugabho lwangcolisa umgangatho.
(The vomitting made the floor dirty).
- (b) Ugabho lwakhokelela ekuhambeni kwabantu.
(The vomitting led to the leaving of the people).

bhodla (belch)

A. [Person]:

Class 7: isibhodli (belching person)

1. (a) Isibhodli sabhodla phakathi kwabantu.
(The belching person belched amongst the people).
- (b) Isibhodli sendoda sanikwa amanzi okuthoba unxano.
(The belching man was given water to quench his thirst).
- (c) Isibhodli samadoda sabangela iintloni kwindwendwe.
(The group of belching men caused an embarrassment to the visitors).

bhodla (belch)

B. [Person]:

Class 8: izibhodli (belching persons)

2. (a) Izibhodli zalelwa ukuba zibe yinxalenye yekwayala.
(Belching persons were not allowed to be part of the choir).
- (b) Izibhodli zamadoda zacula kamnandi.
(The belching men sang beautifully).

bhodla (belch)

C. [Person]:

Class 9: imbodli (belching person)

3. (a) Imbodli yavunyelwa ukuba iphumele phandle.
(The belching person was allowed to go outside).

- (b) Imbodli yendoda yasela amanzi.
(The belching man drank some water).
- (c) Imbodli zamadoda zaphiwa inyama.
(The group of belching men were given meat).

rhona (snore)

A. [Person]:

Class 7: isirhoni (snoring person)

1. (a) Isirhoni senza abantu abakwazi ukulala.
(The snoring person made people not to sleep).
- (b) Isirhoni sendoda salala sodwa.
(The snoring man slept alone).
- (c) Isirhoni samadoda sanikwa iyeza.
(The group of snoring men were given medication).

rhona (snore)

B. [Person]:

Class 9: inkroni (expert snoring person)

1. (a) Inkroni yalala imini yonke.
(The expert snoring person slept the whole day).
- (b) Inkroni yendoda yalala ezinzulwini zobusuku.
(The expert snoring man slept in the middle of the night).
- (c) Inkroni zamadoda zalala eholweni.
(The group of expert snoring men slept in the hall).
- (d) Impefumlo ephakamileyo luphawu lokudinwa.
(High breathing is a sign of tiredness).

rhona (snore)

thimla (sneeze)

A. [Person]:

Class 7: isithimli (sneezing person)

1. (a) Isithimli zange sikwazi ukuphangela.
(The sneezing person could not go to work).

- (b) Isithimli sendoda safuna uncedo kugqira
(The sneezing man looked for help from the doctor).
- (c) Isithimli samadoda sabonana nogqirha.
(The group of sneezing men consulted a doctor).

thimla (sneeze)

B. [Person]:

Class 8: izithimli (sneezing men)

- 2. (a) Izithimli zatya inyama.
(The sneezing persons ate meat).
- (c) Izithimli zamadoda zalala kwigumbi elilodwa.
(The sneezing men slept in a separate room).

thimla (sneeze)

C. [Result]:

Class 9: intimlo (sneezing)

- 3. (a) Intimlo ikhokelela kuvaleko lwempumlo.
(The sneezing leads to the blocking of noses).
- (c) Intimlo yabangela umkhuhlane.
(The sneezing resulted in fever).

ncwina (groan)

A. [Person]:

Class 7: isincwini (groaning person)

- 1. (a) Isincwini sanikwa iyeza lentlungu ngugqirha.
(The groaner was given pain medication by the doctor).
- (b) Isincwini sendoda sabalekiselwa esibhedlele.
(The groaning man was rushed to hospital).
- (c) Isincwini samadoda sanikwa iyeza lentlungu.
(The group of groaning men were given pain medication).

ncwina (groan)

B. [Action]:

Class 9: incwina (groaning)

2. (a) Incina ayenzileyo yavusa abantu.
(The groaning he made awakened the people).
- (b) Incwina yavakala ubusuku bonke.
(The groaning was heard the whole night).

lila (cry)

A. [Person]:

Class 5: ilila (a continually crying person)

1. (a) Ilila lahle kwa ngabantwana.
(The crying person was laughed at by the children).
- (b) Ilila lendoda lakhala ubusuku bonke.
(The crying man cried the whole night).
- (c) Ilila lamadoda lagxothwa yinkosi.
(The group of crying men was chased away by the chief).

bila (sweat)

A. [Person]:

Class 1: umbili (sweating person)

1. (a) Umbili wacela amanzi.
(The sweating person asked for water).
- (b) Umbili wendoda waphumla emthunzini.
(The sweating man rested under the shade).

Class 7: isibili (sweating person)

2. (a) Isibili safika nevumba.
(The sweating person arrived with an odour).
- (b) Isibili sendoda kwanyanzeleka ukuba sihlambe.
(The sweating man was forced to wash).
- (c) Isibili samadoda sahlala phandle.
(The group of sweating men sat outside).

bila (sweat)

B. [Manner of event]:

Class 3: umbilo (sweat)

3. (a) Umbilo wamanzisa impahla ayinxibileyo.
(The sweat made the clothes he was wearing wet)
- (b) Umbilo wendoda wabangelwa kukubaleka.
(The sweat of the man was caused by running)

bila (sweat)

C. [Event]:

Class 11: ubilo (sweating, sweat)

4. (a) Ubilo lwaphazamisa imbethi manqindi.
(The sweat disturbed the boxer).
- (b) Ubilo lwenja lwabangelwa bubushushu.
(The sweating of the dog was caused by the high temperature).

zamla (yawn)

A. [Person]:

Class 1: umzamli (yawning person)

1. (a) Umzamli wakhutshelwa phandle ngutitshala.
(The yawning person was sent outside by the teacher).
- (b) Umzamli wendoda walala entlanganisweni.
(The yawning man slept in the meeting).

zamla (yawn)

B. [Manner of event]:

Class 3: umzamlo (manner of yawning, yawning)

2. (a) Umzamlo awenzayo wamangalisa abantu.
(The yawning he made surprised the people).
- (b) Umzamlo wendoda wahlekwa ecaweni.
(The yawning by the man was laughed at in Church).

zamla (yawn)

C. [Person]:

Class 7: isizamli (expert yawning person)

3. (a) Isizamli sazamla into engapheliyo.
(The expert yawning person yawned consistently).
- (b) Isizamli sendoda safika phakathi entlanganisweni.
(The yawning man arrived whilst the meeting was in progress).
- (c) Isizamli samadoda sabonakalisa iimpawu zokudinwa.
(The group of yawning men demonstrated signs of tiredness).

zamla (yawn)

D. [Person]:

Class 8: izizamli (expert yawning persons)

4. (a) Izizamli zakruqula abantu ngokuzamla.
(The expert yawning persons annoyed the people by yawning).
- (b) Izizamli zamadoda zafuna indawo yokulala.
(The expert yawning men looked for a place to sleep).

zamla (yawn)

E. [Event]:

Class 11: uzamlo (yawning)

5. (a) Uzamlo lwenziwa lusana oludiniweyo.
(The yawning was made by the baby).
- (b) Uzamlo lwenzeka ukudinwa kwabantu.
(The yawning occurred once the people became tired).

qhwanyaza (blink)

A. [Person]:

Class 1: umqhwanyazi (a blinking person)

1. (a) Umqhwanyazi wahlekwa ngabantwana.
(The yawning person was laughed at by the children).

- (b) Umqhwanyazi wendoda wasela isiselo esibandayo.
(The blinking man drank a cold drink).

qhwanyaza (blink)

B. [Manner of event]:

Class 3: umqhwanyazo (manner of yawning)

2. (a) Umqhwanyazo wenzeka rhoqo ngumoya.
(The yawning occurred frequently because of the wind).
(b) Umqhwanyazo wendoda waqhubeka imini yonke.
(The yawning by the man occurred the whole day).

qhwanyaza (blink)

C. [Person]:

Class 7: isiqhwanyazi (a blinking person)

3. (a) Isiqhwanyazi sagezelwa ngabantwana ngenxa yokuqhwanyaza..
(The blinker was teased by the children because of blinking).
(b) Isiqhwanyazi sendoda sacela amanzi okusela.
(The blinking man asked for drinking water).
(c) Isiqhwanyazi samadoda sabetha amasela.
(The group of blinking men beat the thieves).

qhwanyaza (blink)

A. [Person]:

Class 7: iziqhwanyazi (blinking men)

4. (a) Iziqhwanyazi zafuna igumbi elilodwa lokuphumla.
(The blinking persons wanted a separate room to rest).
(b) Iziqhwanyazi zamadoda zacima isibane.
(The blinking men put off the lamp).

qhwanyaza (blink)

A. [Event]:

Class 11: uqhwanyazo (blinking)

5. (a) Uqhwanyazo lwamkhathaza imini yonke umfundi.
(The blinking bothered the student the whole day).

- (b) Uqhwanyazo lwanyangwa esibhedlele.
(The blinking was cured at the hospital).

suza (fart)

A. [Person]:

Class 1: umsuzi (farting person)

1. (a) Umsuzi wasela iyeza.
(The farting person drank medication).
- (b) Umsuzi womfo wakhutshelwa ngaphandle egumbini.
(The farting man was taken outside of the room).

suza (fart)

B. [Manner of event]:

Class 3: umsuzo (manner of farting, fart)

2. (a) Umsuzo awenzayo wavakala kumntu wonke endlwini.
(The farting he made was heard by everybody in the house).
- (b) Umsuzo wanuka egumbini.
(The fart was smelling in the room).

suza (fart)

C. [Person]:

Class 7: isisuzi (farting person)

3. (a) Isisuzi sanikwa iyeza lesisu ngugqirha.
(The farting person was given constipation medication by the doctor).
- (b) Isisuzi sendoda sasuzaphandle.
(The farting man farted outside).
- (c) Isisuzi samadoda sagqiba ukuba singangeni endlwini.
(The group of farting men decided not to enter the house).

Class 8: izisuzi (farting persons)

4. (a) Izisuzi zabonana nogqirha.
(The farting persons consulted with the doctor).

- (b) Izisuzi zamadoda zanikwa igumbi elilodwa.
(The farting men were given a separate room).

suza (fart)

D. [Action, Result]:

Class 9: intsuzo (farting)

5. (a) Intsuzo yenziwa kakhulu zihagu.
(The farting is made often by pigs).
(b) Intsuzo ayenzayo yabangela abantu bahamba.
(The farting he made caused the people to leave).

suza (fart)

E.. [Event]:

Class 11: usuzo (farting)

6. (a) Usuzo lweehagu zange luhoywe.
(The farting of the pigs was ignored).
(b) Usuzo lwamdalela iingxaki esikolweni.
(The farting caused him problems at school).

dumzela (murmur)

A. [Person]:

Class 1: umdumzeli (murmuring person)

1. (a) Umdumzeli wathetha into engavakaliyo.
(The murmuring person said something inaudible).
(b) Umdumzeli wendoda wasebeza xa athethayo.
(The murmuring man whispered when talking).

Class 7: isidumzeli (expert murmuring person)

2. (a) Isidumzeli zange sivunyelwe ukuba singene endlwini.
(The expert murmuring person was not allowed to enter into the house).
(b) Isidumzeli sendoda savuthela ixilongo.
(The expert murmuring person blew a horn).

dumzela (murmur)

B. [Manner of event]:

- Class 3: 3. (a) Umdumzelo wavakala emapoliseni.
(The murmuring was audible to the police officers).
- (b) Umdumzelo womntwana wanqandwa ngumzali.
(The murmuring of the child was stopped by the parent).

dumzela (murmur)

C. [Action, Result]:

- Class 9: indumzelo (murmuring)
4. (a) Indumzelo phandle yavusa indoda.
(The murmuring outside awoken the man).
- (b) Indumzelo yabafundi yamenza utitshala wanomsindo.
(The murmuring of the students made the teacher angry).

dumzela (murmur)

A. [Event]:

- Class 11: udumzelo (murmuring)
5. (a) Udumzelo lwenzeka umdlalo wonke.
(The murmuring occurred throughout the game).
- (b) Udumzelo lwevuvuzela lwavakala ngexesha le world cup.
(The murmuring of the vuvuzela was heard during the world cup).

gula (sick)

A. [Person]:

- Class 1: umguli (patient, ill / sick patient)
1. (a) Umguli usiwe esibhedlele.
(The sick person has been sent to hospital).
- (b) Umguli ulele.
(The sick person is asleep).

gula (sick)

B. [Manner]:

Class 3. umgulo (sickness)

2. (a) Umgulo wamongamela umfana.
(The manner of sickness overwhelmed the man).
- (b) Umgulo wanyangwa ngeyeza.
(The sickness was treated by the medication).

gula (sick)

C. [Person]:

Class 7: isiguli (patient, ill / sick patient)

3. (a) Isiguli sanikwa amayeza ngumongikazi.
(The patient was given medicines by the nurse).
- (b) Isiguli somntwana sasiwa kwagqirha.
(The sick child was taken to the doctor).
- (c) Isiguli samadoda sahlaliswa kwigumbi elilodwa.
(The group of sick men were sitted in a separate room).

gula (sick)

D. [State]:

Class 7: isigulo (sickness)

4. (a) Isigulo anaso asaziwa ngogqirha.
(The sickness he has is not known by the doctors).
- (b) Isigulo sabangelwa yinyama ebomvu.
(The sickness was caused by the red meat).

gula (sick)

E. [Result]:

Class 11: ugulo (sickness)

5. (a) Ugulo lwamenza akabi namandla.
(The sickness made him weak).
- (b) Ugulo lwamtsho wabhitya.
(The sickness made him thin).

limala (hurt, injure)

A. [Person]:

Class 1: umlimali (injured person, cripple)

1. (a) Umlimali uhamba ngesitulo.
(The injured person walks with a wheelchair).
- (b) Umlimali waya ecaweni.
(The injured person went to church).

limala (hurt, injure)

B. [Person]:

Class 7: isilima (cripple)

2. (a) Isilima sanikwa iintonga zokuhamba.
(The cripple was given crutches to walk).
- (b) Isilima sendoda zange sifike entlanganisweni.
(The cripple man did not arrive at the meeting).
- (c) Isilima samadoda saseka umbutho.
(The group of crippled men formed an association).

limala (hurt, injure)

C. [Person]:

Class 8: izilima (cripples)

3. (a) Izilima zacela amalizo.
(The cripples asked for donations).
- (b) Izilima zamadoda zasela utywala.
(The crippled men drank liquor).

limala (hurt, injure)

D. [Event]:

Class 11: ulimalo (injury)

4. (a) Ulimalo lwabangela akaphangela.
(The injury made him not to go to work).
- (b) Ulimalo lwachaphazela abantu abaninzi.
(The injury affected a lot of people).

dumba (swell)

A. [Person]:

Class 1: umdumbi (swollen persons)

1. (a) Umdumbi waya kwagqirha.
(The swollen person went to the doctor).
- (b) Umdumbi wacela amanzi.
(The swollen person asked for water).

dumba (swell)

B. [State]:

Class 3: umdumbo (swelling)

2. (a) Umdumbo wathomalala.
(The swelling subsided).
- (b) Umdumbo wavala amehlo enja.
(The swelling closed the dog's eyes).

dumba (swell)

C. [Person]:

Class 7: isidumbi (swollen person)

3. (a) Isidumbi sanyangwa esibhedlele.
(The swollen person was treated at the hospital).
- (b) Isidumbi somfo zange sikwazi ukusebenza emsebenzini.
(The swollen man could not do the work at work).
- (c) Isidumbi sabafo sathunyelwa ekliniki.
(The group of swollen men was sent to the clinic).

dumba (swell)

D. [Person]:

Class 8: izidumbi (swollen persons)

4. (a) Izidumbi zafumana unyango.
(The swollen persons received treatment).
- (b) Izidumbi zabafo zafaka isimangalo emapoliseni.
(Swollen men laid a charge with the police).

dumba (swell)

E. [State]:
Class 9:

indumbo (swelling)

5. (a) Indumbo ebusweni ayiqhelekanga.
(The swelling in the face is not familiar).
- (b) Indumbo imenze akaphangela.
(The swelling made him not to go to work).

Class 11: udumbo (swelling)

6. (a) Udumbo lwanyangwa esibhedlela.
(The swelling was treated at the hospital).
- (b) Udumbo lwamhambisa kakubi.
(The swelling made him walk with difficulty).

dangala (weak, tired)

A. [Person]:

Class 1: umdangali (an extremely weak / lazy person)

1. (a) Umdangali walala emini.
(The lazy person slept during the day).
- (b) Umdangali uhambile.
(The lazy person has left).

dangala (weak, tired)

B. [State]:

Class 3: umdangalo (laziness)

2. (a) Umdangalo walalisa umsebenzi.
(The laziness made the worker sleep).
- (b) Umdangalo wapheliswa kukuna kwemvula.
(The laziness was stopped by raining).

dangala (weak, tired)

C. [Person]:

Class 5: idangala (an extremely weak / lazy person)

3. (a) Idangala lazenza umntu ogulayo.
(The lazy person pretended to be sick).
- (b) Idangala lendoda lalala imini yonke.
(The lazy man slept the whole day).
- (c) Idangala lamadoda lahlala lingenazinkomo.
(The group of lazy men stayed without cattle).

dangala (weak, tired)

D. [Person]:

Class 7: isidangali (weak, lazy person)

4. (a) Isidangali salala imini yonke.
(The weak person slept the whole day).
- (b) Isidangali sendoda zange sifune ukusebenza.
(The lazy man did not want to work).
- (c) Isidangali sabadlali sadlala kakubi umdlalo waso.
(The group of lazy players played badly their match).

dangala (weak, tired)

E. [Person]

Class 8: izidangali (weak / lazy persons)

5. (a) Izidangali zalala imini yonke.
(The lazy persons slept the whole day).
- (b) Izidangali zamakwenkwe zasetyenziswa ngenkani.
(The lazy boys were forced to do the work).

dangala (weak, tired)

F. [State]:

Class 9: indangalo (tiredness, fatigue)

6. (a) Indangalo abadlali abanayo ibenze
baphulukana nomdlalo.
(The tiredness the players have has caused them to lose
the game).

- (b) Indangalo yamenza akakwazi ukutya.
(The fatigue made him unable to eat food).

dangala (weak, tired)

G. [Result]:

Class 1: udangalo (tiredness, fatigue)

7. (a) Udangalo lwatyhafisa abadlali.
(The fatigue made the players weak).
(b) Udangalo lwabadlali lwaqapheleka kumqeqeshi.
(The tiredness of the players was noticeable to the coach).

rhawuzela (itch)

A. [Person]:

Class 7: isirhawuzeli (itching person)

1. (a) Isirhawuzeli sazithwisha phakathi kwabantu.
(The itching person scratched himself amongst the people).
(b) Isirhawuzeli somfo soloko sizikrwela.
(The itching man kept on scratching himself).
(c) Isirhawuzeli sabafo salindela umongikazi imini yonke.
(The group of itching men waited for the nurse the whole day).

rhawuzela (itch)

B. [Person]:

Class 8: izirhawuzeli (itching persons)

2. (a) Izirhawuzeli zaqubha emlanjeni.
(The itching persons swam in the river).
(b) Izirhawuzeli zabafo zangena ngaphakathi endlwini.
(The itching men entered inside the house).

rhawuzela (itch)

C. [Feeling]:

Class 9: inkrawuzelo (itching)

3. (a) Inkrawuzelo yamenza akonwaba esikolweni.
(The itching made him uncomfortable at school).
- (b) Inkrawuzelo yomzimba imele ukunyangwa xa ingapheliyo.
(The itching of the body ought to be treated when it does not end).

qhwarela (limp)

A. [Person]:

Class 1: umqhwareli (limping person)

1. (a) umqhwareli wanikwa isitulo ahlale.
(The limping person was given a chair to sit on).
- (b) Umqhwareli wendoda waziqhubela imoto.
(The limping man drove his car by himself).

qhwarela (limp)

B. [Person]:

Class3: umqhwarelo (limping)

2. (a) Umqhwarelo waba ngumqobo kumdlali.
(The limping became an impediment to the player).
- (b) Umqhwarelo wabadlali zange ubathibaze bangaphumeleli.
(The limping of the players did not deter them from winning).

C. [Person]:

Class 7: isiqhwala (limping / hobbling person)

3. (a) Isiqhwala saqhuba imoto.
(The limping person drove the car).
- (b) Isiqhwala sendoda salima umbona.
(The limping man ploughed milies).

- (c) Isiqhwala samadoda sakhwela ibhasi.
(The group of limping men boarded a bus).

qhwarela (limp)

D. [Person]:

Class 8: iziqhwala (limping / hobbling persons)

4. (a) Iziqhwala zazuza izipho.
(The limping persons received gifts).
(b) Iziqhwala zamadoda zafunda ukuqubha.
(The limping men learnt to swim).

qhwarela (limp)

E. [State]:

Class 9: inkqwalelo (limping)

5. (a) Inkqwalelo anayo imhambisa kanzima.
(The limping he has causes him to walk with difficulty).
(b) Inkqwalelo yenzeka engozini yemoto.
(The limping occurred in a car accident).

qhwarela (limp)

F. [Event]:

Class 11: uqhwarelo (limping)

6. (a) Uqhwarelo lwendlulamthi lwaba ngumfuziselo wobuthathaka engonyameni.
(The limping of the giraffe was an indication of weakness to the lion).
(b) Uqhwarelo lwembaleki lwabangela ingawungeneli umdyarho.
(The limping of the athlete caused it not to enter the race).

In summary, it is clear from the above lexical schematic representation of the verbs relating to the body that these verbs can be nominalised in almost all the noun classes except for noun

class 5 where only two deverbal nominals **ilila** and **idangala** can be derived. The lexical semantic type for the deverbal nominals derived from noun class 1 of verbs relating to the body denotes a similar interpretation, person. In noun class 9 of the verbs relating to the body only those deverbal nominals with the suffix **-i** denotes person as is illustrated by **inkohleli**, **imbodli**, **inkroni** and **inkqwanyazi** respectively. The deverbatives in noun class 1, 7/8 and 9 have the interpretation of an individual-level nominals (ILNs). The interpretation in noun class 7 denoting person may be that of a stage-level nominals (SLNs) depending on how the deverbal noun is used. The deverbatives in noun class 5 denoting person have an interpretation of a stage-level nominals (SLNs). The semantic type for the deverbative nominals derived from noun class 11 denote an Event for all verbs relating to the body from this noun class.

4.2.4 Experiencer verbs

Áfarli (2002 : 129) maintains that experiencer verbs denote feelings or emotions. The lexical schematic representation below shows various deverbatives that have been derived from the experiencer verbs. These deverbal nominals are categorized according to the following noun classes 1,5, 7, 8, 9 and 11.

	Class 1	class 5	class 7	class 8	class 9	class 11
qumba	umqumbi	iqumba	isiqumbi	iziqumbi	ingqumbo	uqumbo
vuya	umvuyi	ivuya	isivuyi	izivuyi	imvuyo	uvuyo
khathala	umkhathali		isikhathali	izikhathali	inkathalo	ukhathalo
ngcangcazela	umngcangcazeli		isingcangcazeli / o	izingcangcazeli	ingcangcazelo	ungcangcazelo
khweleta	umkhweleti		isikhweleti	izikhweleti	inkweleti	ukhweleto
dandatheka	umdandatheki		isidandatheki	izidandatheki	indandatheko	udandatheko
phambana	umphambani		isiphambani	iziphambani	impambano	uphambano
dana	umdani	idana	isidani	izidani	indano	udano
thiya	umthiyi				intiyi	uthiyi

In the lexical schematic representation below the various classes of the deverbal nominals derived from various experiencer verbs are classified in terms of semantic type, such as Person, State and Event. The categorization of each deverbal nominal class is shown by means of a binary feature (+) for the various semantic types.

Class	qumba	vuya	khathala	ngcangcazela	khweleta	dandatheka	phambana	dana	thiya
Person									
1	+	+	+	+	+	+	+	+	+
5	+	+						+	
7	+	+	+	+	+	+	+	+	
8	+	+	+	+	+	+	+	+	
9					+				
State									
9	+	+	+	+		+	+	+	+
Event									
11	+	+	+	+	+	+	+	+	+

qumba (be angry)

A. [Person]:

Class 1: Umqumbi (angry person)

1. (a) Umqumbi akafunanga kutya.
(The angry person did not want to eat).
- (b) Umqumbi zange athethe namntu.
(The angry person did not speak with anyone).

qumba (be angry)

B. [Person]:

Class 5: iqumba (angry person)

2. (a) Iqumba zange lithethe namntu.
(The angry person did not speak with anyone).
- (b) Iqumba lendoda zange lifune kumamela.
(The angry man did not want to listen).
- (c) Iqumba lamadoda lemka lingatyanga.
(The group of angry men left without eating).

qumba (angry)

C. [Person]:

Class 7: isiqumbi (angry person)

3. (a) Isiqumbi safaka isikhalazo kuMasipala.
(The angry person lodged a complaint to the Municipality).

- (b) Isiqumbi sendoda zange sisebenze ngalo mini.
(The angry person did not work that day).
- (c) Isiqumbi samadoda sangenelela ugwayimbo lwabasebenzi.
(The group of angry men joined the strike of the workers).

qumba (angry)

D. [State]:

Class 9: ingqumbo (wrath, extreme anger)

4. (a) Ingqumbo aya kuba nayo iyoyikeka.
(The wrath he would have is frightening).
- (b) Ingqumbo yezinyanya iyoyikisa.
(The wrath of the ancestors is frightening).

qumba (angry)

E. [Result]:

Class 11: uqumbo (anger)

5. (a) Uqumbo lwabangela abathethisana.
(The anger made them not to speak to one another).
- (b) Uqumbo lwenza abahlobo ababulisana.
(The anger caused the friends not to greet one another).

The deverbatives derived from the experiencer verb **qumba** can be found in almost all the specified noun classes. The lexical semantic type interpretation for the deverbal nominals derived from noun classes 1, 5, 7/8 denote person. The deverbal nominals derived from the experiencer verbs can be found in almost all the noun classes with some few exceptions in noun class 5 where a limited number of deverbal nouns are derived.

vuya (rejoice)

A. [Person]:

Class 1: umvuyi (rejoicing person)

1. (a) Umvuyi walala ebusuku.
(The rejoicing person slept at night).

- (b) Umvuyi wahamba ekuseni.
(The rejoicing person left early in the morning).

vuya (rejoice)

B. [Person]:

Class 5: ivuya (rejoicing person)

2. (a) Ivuya lavuka ngentseni.
(The rejoicing person woke up very early).
- (b) Ivuya lendoda lavuyela ukuphumela iimviwo.
(The rejoicing man celebrated passing the examinations).
- (c) Ivuya lamadoda laxhela inkomo.
(The group of rejoicing men slaughtered a cattle).

vuya (rejoice)

C. [Person]:

Class 7: isivuyi (rejoicing person)

3. (a) Isivuyi sadlalisa abantwana.
(The rejoicing person made the children to play).
- (b) Isivuyi sendoda sahamba sinolonwabo.
(The rejoicing man left full of joy).
- (c) Isivuyi samadoda safuna ukulala.
(The group of rejoicing men wanted to sleep).

Class 8: izivuyi (rejoicing persons)

4. (a) Izivuyi zakhwela iibhayisekile.
(The rejoicing persons climbed on the bicycles).
- (b) Izivuyi zamadoda zacula imini yonke.
(The rejoicing men sang the whole day).

vuya (rejoice)

D. [Result]:

Class 9: imvuyo (joy)

5. (a) Imvuyo yokuphumelela imviwo yamonwabisa.

(The joy of passing the examinations made him happy).

- (b) Imvuyo yabavoti yapheliswa ziziphumo ezingalindelekanga.

(The joy of the voters was stopped by the unexpected results).

vuya (rejoice)

E. [Event]:

Class 11: uvuyo (rejoicing)

6. (a) Uvuyo lomntwana lonwabisa umzali.
(The rejoicing of the child made the parent happy).
- (b) Uvuyo lwadala iinyembezi ebazalini.
(The rejoicing caused tears to the parents).

khathala (be concerned)

A. [Person]:

Class 1: umkhathali (concerned person)

1. (a) Umkhathali wasusainja eyenzakeleyo endleleni.
(The concerned person removed the injured dog on the road).
- (b) Umkhathali womfo walungiselela iindwendwe indawo yokulala.
(The concerned man prepared a place to sleep for the visitors).

khathala (be concerned)

B. [Person]:

Class 7: isikhathali (concerned person)

2. (a) Isikhathali salungiselela iindwendwe indawo yokulala.
(The concerned person made provision for the visitors to sleep).

- (b) Isikhathali sendoda sanceda abantu abenzakeleyo.
(The concerned person helped the injured people).
- (c) Isikhathali samadoda saqesha imoto yokuya eMonti.
(The group of concerned men hired a car to go to East London).

khathala (be concerned)

C. [Person]:

Class 8: izikhathali (concerned persons)

3. (a) Izikhathali zanceda abantu abonzakeleyo.
(The concerned persons helped the injured people).
- (b) Izikhathali zamadoda zahlangula abantu bezika elwandle.
(The concerned men saved people from drowning at sea).

khathala (be concerned)

D. [State]:

Class 9: inkathalo (concern, commitment)

4. (a) Inkathalo isisiseko kumfundi ngamnye.
(Commitment is a foundation in each and every student).
- (b) Inkathalo sisiseko esibalulekile kukhuliso lomntwana.
(Commitment is a sound foundation in raising a child).

khathala (be concerned)

E. [Event]:

Class 11: ukhathalo (concern, commitment)

5. (a) Ukhathalo lwamapolisa ekubambeni imigulukudu lwaxolisa uluntu.
(The concern of the police in arresting the criminals satisfied the community).

- (b) Ukhathalo lukatitshala ekufundiseni abafundi lwabenza baphumelela.
(The commitment of the teacher in teaching the students made them to succeed).

ngcangcazela (tremble)

A. [Person]:

Class 1: umngcangcazeli (shaky person)

1. (a) Umngcangcazeli wasuza ngenxa yoloyiko.
(The shaky person farted because of fear).
- (b) Umngcangcazeli wendoda waziqinisa kuba engafuni kuhlekwa.
(The shaky man pretended to be strong because he did not want to be laughed at).

ngcangcazela (tremble)

B. [Person]:

Class 7: isingcangcazeli (extremely shaky person)

2. (a) Isingcangcazeli zange sikwazi ukubhala kakuhle.
(The extremely shaky person could not write well).
- (b) Isingcangcazeli sendoda soyika inyoka.
(The extremely shaky man became afraid of a snake).
- (c) Isingcangcazeli samadoda sacula ngaphandle kokuzithemba).
(The group of extremely shaky men sang without confidence).

ngcangcazela (tremble)

C. [Person]:

Class 8: izingcangcazeli (extremely shaky / trembling persons)

3. (a) Izingcangcazeli zabanjwa ngamapolisa.
(The extremely trembling persons were arrested by the police).

- (b) Izingangcazeli zamadoda zoyika inyoka.
(The extremely trembling men were afraid of the snake).

ngcangcazela (tremble)

D. [State]:

Class 9: ingcangcazelo (shakiness / unsteadiness)

4. (a) Ingcangcazelo inakho ukubangelwa kukugula.
(Shakiness may be caused by sickness).
- (b) Ingcangcazelo kubaqubhi yabangelwa kukubanda kwamanzi.
The shakiness to swimmers was caused by the cold water).

ngcangcazela (tremble)

E. [Action]:

Class 11: ungcangcazelo (trembling)

5. (a) Ungcangcazelo lwabangelwa yingqele.
(The trembling was caused by the cold).
- (b) Ungcangcazelo lwendoda lwabangela ukrokro kumapolisa.
(The trembling man raised suspicion of the police officers).

khweleta (be jealous)

A. [Person]:

Class 1: umkhweleti (jealous person)

1. (a) Umkhweleti wabetha iqabane lomyeni.
(The jealous person assaulted her husband's friend).
- (b) Umkhweleti womfazi wachithela indoda ngamanzi.
(The jealous wife poured water into her husband).

khweleta (be jealous)

B. [Person]:

Class 7: isikhweleti (jealous person)

2. (a) Isikhweleti sathuka indoda esidlangalaleni.
(The jealous person insulted her husband in public).
- (b) Isikweleti somfazi salela indoda ukuba ihambe ngemoto.
(The jealous wife refused to allow the husband to go with the car).
- (c) Isikhweleti sabafazi zange siye emtshatweni.
(The group of jealous women did not go to the wedding).

khweleta (be jealous)

C. [Person]:

Class 8: izikhweleti (jealous persons)

3. (a) Izikhweleti zalandela amadoda.
(The jealous persons followed their men).
- (b) Izikhweleti zabafazi zahlala ecaleni kwamadoda.
(The jealous women were sitted next to the men).

khweleta (be jealous)

D. [Person]:

Class 9: inkweleti (extremely jealous person)

4. (a) Inkweleti yarhorhozela emva komyeni ingabonwa.
(The extremely jealous person followed her husband without being seen).
- (b) Inkweleti yomfazi yabangela indoda yaso ayabi nazihlobo.
(The extremely jealous woman caused her husband not to have friends).

khweleta (be jealous)

E. [State]:

Class 11: ukhweleto (jealousy)

5. (a) Ukhweleto lwadala ingxabano ekhayeni.
(Jealousy caused a friction in the household).
- (b) Ukhweleto lomfazi lwadala ubutshaba ekuhlaleni.
(The jealousy of the woman caused enmity in the neighbourhood).

dandatheka (be anxious)

A. [Person]:

Class 1: umdandatheki (anxious person)

1. (a) Umdandatheki zange akwazi ukubhala iimviwo.
(The anxious person could not write examinations).
- (b) Umdandatheki wendoda wafuna uncedo kwiingcali zengqondo.
(The anxious man seek help from the pyschiatrist).

dandatheka (be anxious)

B. [Person]:

Class 7: isidandatheki (anxious person)

2. (a) Isidandatheki sakhathazeka kakhulu.
(The anxious person was emotionally hurt).
- (b) Isidandatheki sendoda sazixhoma.
(The unhappy person hanged himself).
- (c) Isidandatheki samadoda sabalekiselwa esibhedlele.
(The group of anxious men were rushed to hospital).

dandatheka (be anxious)

C. [Person]:

Class 8: isidandatheki (anxious persons)

3. (a) Izidandatheki zange zikwazi ukudlala.
(The anxious persons could not play).

- (b) Izidandatheki zamadoda zafumana iziphumo zemviwo.
(The anxious men received examination results).

dandatheka (be anxious)

D [State]:

Class 9: indandatheko (misery, despair)

4. (a) Indandatheko yamenza akabi nakuqiqa ngokufanelekileyo.
(The despair made him not think properly).
- (b) Indandatheko eyabangelwa kukubhubha kwentombi yakhe yamenza akaphangela.
The misery caused by the death of her daughter made her not to come to work).

dandatheka (be anxious)

E. [Event]:

Class 11: udandatheko (misery, despair)

5. (a) Udandatheko lwabonakala ebusweni babadlali.
(The despair was visible on the players faces).
- (b) Udandatheko olwabangelwa kufika kwenkanyamba lwacaca kubahlali.
(The misery caused by the arrival of the tornado was visible to the community).

phambana (be mad)

A. [Person]:

Class 1: umphambani (mad person)

1. (a) Umphambani wabetha abantu esitalatweni.
(The mad person assaulted people on the street).
- (b) Umbambani wathunyelwa kwisibhedlele sabagula ngengqondo.
(The mad person was sent to the psychiatric hospital).

phambana (be mad)

B. [Person]:

Class 7: isiphambani (a mad person)

2. (a) Isiphambani sahamba singazi nalapho siya khona.
(The mad person left without knowing where he was going).
- (b) Isiphambani sendoda sabetha abantu esitalatweni.
(The mad man beat the people on the street).
- (c) Isiphambani samadoda sathunyelwa esibhedlele.
(The group of mad men were sent to the hospital).

phambana (be mad)

C. [Person]:

Class 8: iziphambani (mad persons)

3. (a) Iziphambani zathunyelwa esibhedlele.
(The mad persons were sent to the hospital).
- (b) Iziphambani zamadoda zabizelwa bucala.
(The mad men were called aside).

phambana (be mad)

D. [State]:

Class 9: impambano (madness)

4. (a) Impambano sisigulo esinganyangekiyo.
(Madness is an illness that is incurable).
- (b) Impambano yamenza wayeka ukufunda.
(Madness made him to abandon school).

phambana (be mad)

E. [Event]:

Class 11: uphambano (madness)

5. (a) Uphambano lomfundi lwenza wasiyeka isikolo.
(The madness of the student caused him to abandon school)

dana (disappoint)

A. [Person]:

Class 1: umdani (disappointed / disgraced person)

1. (a) Umdani wacela uxolo ngesenzo esibi asenzileyo.
(The disgraced person asked for forgiveness about his bad deed).
- (b) Umdani wabazimela abantu .
(The disgraced person avoided the people).

dana (disappoint)

B. [Person]:

Class 5: idana (disappointing person)

2. (a) Idana lalelwa ukungena esikolweni.
(The disappointing person was not allowed entry at the school).
- (b) Idana lendoda lacela uxolo esidlangalaleni.
(The disappointing man apologised in public).
- (d) Idana lamadoda lazifihla endlwini.
(The group of disappointing men concealed themselves in the house).

dana (disappoint)

C. [Person]:

Class 7: isidani (disappointing person)

3. (a) Isidani sakhetha ukuhamba kunokuhlala.
(The disappointing person decided to leave than stay).

- (b) Isidani sendoda sagqiba ekuyekeni ukusela utywala.
(The disappointing man decided to stop drinking liquor).
- (c) Isidani samadoda sacela uxolo ngesenzo esisenzileyo.
(The group of disappointing men apologised for their actions).

dana (disappoint)

D. [Person]:

Class 8: izidani (disappointing persons)

- 4. (a) Izidani zabonakalisa ukungakhathali emdlalweni.
(The disappointing persons displayed lack of purpose in the match).
- (b) Izidani zabafo zakhetha ukuzihlalela.
(The group of disappointing men decided to stay alone).

dana (disappoint)

E. [State]:

Class 9: indano (shamefulness)

- 5. (a) Indano yamenza wacela uxolo.
(Shamefulness made him to apologise).
- (b) Indano ingabangela bayeke ukulwa.
(Shamefulness may result in them not to fight).

dana (disappoint)

F. [Event]:

Class 11: udano (disappointment)

- 6. (a) Udano lokungaphumeleli lwalubhalwe ebusweni kubadlali.
(The disappointment of not winning was written on the player's faces).

- (b) Udano lokufika sele kuvaliwe evenkileni lolungathethekiyo.

(The disappointment of arriving late at the airport meant that he missed his flight).

thiya (hate)

A. [Person]:

Class 1: umthiyi (hating person)

1. (a) Umthiyi wabangela impixano phakathi kwabantu.
(The hating person caused a conflict amongst the people).
- (b) Umthiyi wendoda waba likheswa kwamanye amadoda.
(The hating person was ostracised from other men).

thiya (hate)

B. [State]:

Class 9: intiyo (hatred)

2. (a) Intiyo anayo yabangela aluhlasele utshaba lwakhe.
The hatred he has caused him to attack his enemy).
- (b) Intiyo pahakathi kwabantwana yapheliswa ngabazali.
(The hatred amongst the children was stopped by the parents).

thiya (hate)

C. [Event]:

Class 11: uthiyo (hatred)

3. (a) Uthiyo lwamshiya nesazela.
(The hatred left him with a guilty conscience).

- (b) Uthiyo lwadala impixano.
(The hatred caused a conflict).

In summary, it is clear from the above lexical semantic representation of the experiencer verbs that these verbs can be nominalised in almost all the noun classes except for noun class 5 where only three deverbal nominals **iqumba**, **ivuya** and **idana** can be derived. The lexical semantic type for the deverbal nominals derived from noun classes 1, 5, 7/8 of experiencer verbs denotes a similar interpretation, person which denotes a [derogatory] interpretation in noun class 5. In noun class 9 of the experiencer verbs only one deverbal nominals with the suffix **-i** denote person as is illustrated by **inkweleti**, the rest of the deverbal nominals derived from this noun class denote a state interpretation.

The deverbatives in noun class 1, 7/8 and 9 with the suffix **-i** denoting person have the interpretation of an individual-level nominals (ILNs). In noun class 7 denoting person the interpretation may be that of a stage-level nominals (SLNs) depending on how the deverbal noun is used. The deverbatives in noun class 5 denoting person have an interpretation of a stage-level nominals (SLNs). The semantic type for the deverbative nominals derived from noun class 11 denote an Event across board for all the experiencer verbs from this noun class.

4.2.5 Weather verbs

Levin (1993 : 276) describes weather verbs as verbs that describe different types of weather. The lexical schematic representation below displays various deverbatives from the following noun classes 3, 7, 8, 9 and 11 that are derived from various intransitive weather verbs.

	Class 3	class 7	class 9	class 11
vuthuza	umvuthuzo	isivuthuzi	imvuthuzo	uvuthuzo
khithika		isikhithizo	inkithiko	ukhithiko
duduma			indudumo	ududumo
khwitsha			inkwitsho	ukhwitsho
fefa				ufefo
gxigxiza				ugxigxizo

In the lexical schematic representation below the various classes of the deverbatives derived from various weather verbs are classified in terms of semantic type, such as Result, Instrument and Action, Manner. The categorization of each deverbal nominal class is specified by means of a binary feature (+) for the various semantic types.

Class	vuthuza	khithika	duduma	khwitsha	ufefo	ugxigxizo
Result						
9	+	+	+	+		
Instrument						
7	+	+				
Event, Manner						
11	+	+	+	+	+	+
3	+					

vuthuza (blow)

A. [Result]:

Class 3: umvuthuzo (manner of blowing)

1. (a) Umvuthuzo wawisa imithi.
(The blowing wind fell trees).

- (b) Umvuthuzo wazisa imvula.
(The blowing wind brought rain).

vuthuza (blow)

B. [Instrument]

Class 7: isivuthuzi (blowing instrument)

2. (a) Isivuthuzi sadala uthuli.
(The blowing instrument caused dust).
- (b) Isivuthuzi sawavuthela abheka kude amagqabi.
(The blowing instrument blew away the leaves).

vuthuza (blow)

C. [Process]:

Class 9: invuthuzo (wind blow)

3. (a) Invuthuzo yawisa imithi.
(The wind blow fell trees).
- (b) Invuthuzo yomoya yadala umonakalo.
(The wind blow caused damages).

[Event]

Class 11: uvuthuzo (blowing)

4. (a) Uvuthuzo lomoya ludambile.
(The blowing wind has subsided).
- (b) Uvuthuzo luze nengqele.
(The blowing wind brought cold).

The deverbatives derived from the weather verb **vuthuza** can be found in several of the specified noun classes. The lexical semantic type interpretation for the deverbal nominals derived from noun classes 3 denote event, manner. This deverbal noun is the only one that is formed in noun class 3.

khithika (snow)

A. [Instrument]:

Class 7: isikhithizo (snow instrument)

1. (a) Isikhithizo senza ikhephu elininzi.
(The snow instrument made a lot of snow).
- (b) Isikhithizo siphathwa ngenyameko.

(The snow instrument is handled with care).

khithika (snow)

B. [Result]:

Class 9: inkithiko (falling snow)

2. (a) Inkithiko iyathandwa ngabantu.
(Falling snow is liked by people).
- (b) Inkithiko yekhephu yeza kunye nengqele.
(The falling snow brought with it some cold).

khithika (snow)

C. [Event, Manner]:

Class 11: ukhithiko (snowing)

3. (a) Ukhithiko lwakhokelela ekuvalweni kwendlela.
(Snowing led to the closure of the road).
- (b) Ukhithiko lwazisa ingqele.
(Snowing brought a cold).

duduma (thundering, way of thundering)

A. [Result]:

Class 9: indudumo (thunderbolts)

1. (a) Indudumo zibangela ukutsha kwamadlelo.
(Thunderbolts cause veld fires).
- (b) Indudumo zininzi eRhawutini.
(There is plenty of thunderbolts in Johannesburg).

duduma (thundering)

B. [Event, Manner]:

Class 11: ududumo (thundering)

2. (a) Ududumo lwenzeka ebusuku.
(Thundering occurred in the evening).
- (b) Ududumo lwabangela abantwana boyika.
(Thundering caused the children to be afraid).

khwitsha (drizzle)

A. [Result]:

Class 9: inkwitsho (drizzling)

1. (a) Inkwitsho yabenza manzi abantwana.
(Drizzling made the children wet).
- (b) Inkwitsho yavuyelwa ngamafama.
(The drizzling was liked by the farmers).

khwitsha (drizzle)

A. [Process]:

Class 11: ukhwitsho (drizzling)

2. (a) Ukhwitsho lwamanzisa abantwana.
(The drizzling made the children wet).
- (b) Ukhwitsho lwemvula lwenzeka kusasa.
(The drizzling of rain occurred in the morning).

fefa (drizzle)

A. [Event, Manner]:

Class 11: ufefo (drizzling)

1. (a) Ufefo lungabenza manzi abantu.
(The drizzling may make people wet).
- (b) Ufefo olungapheliyo luzisa ingqele.
(Persistent drizzling brings cold).

gxigxiza (rain)

A. [Event, Manner]:

Class 11: ugxigxizo (persistent rain)

1. (a) Ugxigxizo lwenza abantu manzi.
(Persistent rain made the people wet).
- (b) Ugxigxizo lwemvula lonakalisa indlela.
(Persistent rain damaged the road).

In summary, it is clear from the above lexical semantic representation of the weather verbs that these verbs can be nominalised mostly in the noun classes 9 and 11 respectively. The lexical semantic type for the deverbal nominals derived from these two noun classes denote result and event, manner, respectively. The deverbal nominals derived from the noun class 7 denote instrument as is illustrated by the deverbal nominals **isivuthuzi** and **isikhithizo** respectively.

4.2.6 Motion verbs with a locative argument

4.2.6.1 The locative refers to a location

The motion verbs as described by Levin in 4.2.1 can appear with a locative argument. In the lexical schematic representation below demonstrates various deverbatives from the following noun classes 1, 3, 5, 7, 8, 9 and 11 that are derived from various intransitive motion verbs with a locative argument.

	Class 1	class 3	class 6	class 7	class 9	cl. 11	cl. 14
hlala	umhlali	umhlalo		isihlalo	intlalo	uhlalo	ubuhlali
ima	ummi			isimo	imo	umo	ubumo
fika	umfiki	umfiko		isifiko isifiki	imfiki/o	ufiko	ubufiko
ngena	umngeni	umngeno	amangeno		ingena	ungeno	ubungeno
sala	umsali	umsalo				usalo	ubusali

In the lexical schematic representation below the various classes of the deverbal nominals derived from motion verbs are classified in terms of semantic type, such as Person, Event, Manner of Event, Result, Action, Culture, Artifact and Quality. The categorization of each deverbal nominal class is specified by means of a binary feature (+) for the various semantic types.

Class	hlala	ima	fika	ngena	sala
Person					
1	+	+	+	+	+
7			+		
9			+	+	
Event, Manner of Event					
3	+		+	+	
9	+				
11	+				
Result					
3					+
7		+			
9		+			
11			+	+	+
Action					
9			+		
Culture					
11				+	
Artifact					
6				+	
7	+				
Quality					
11		+			
14	+	+	+	+	+

hlala (sit, stay)

A. [Person]:

Class 1: umhlali (resident)

1. Umhlali wabamba amasela.
(The resident caught the thieves)

hlala (sit, stay)

B. [Event Manner]:

Class 3: umhlalo (way of staying / sitting)

2. (a) Umhlalo etywaleni uzisa ingxaki.
(The sitting in shebeens brings problems).
- (b) Umhlalo wabafazi emlanjeni ukholisa ukuba nengoma.
(The sitting of women along the river is usually accompanied by a song).

hlala (sit, stay)

C. [Artifact]:

Class 7: isihlalo (chair, position)

3. (a) Isihlalo sinikwe ixhego elidiniweyo.
(The chair was given to a tired old man).
- (b) Isihlalo esiphezulu sinikwe uJunior emsebenzini.
(The high position has been given to Junior at work).

hlala (sit, stay)

D. [Event, Manner]:

Class 9: intlalo (manner of living)

4. (a) Intlalo abayihleliyo iyasizeleka.
(The manner of living they are staying is pitiful).
- (b) Intlalo embi yamenza wahamba.
(The bad manner of living caused him to leave).

hlala (sit, stay)

E. [Event, Manner]:

Class 11: uhlalo (manner of staying / sitting)

5. (a) Uhlalo daxa luyadinisa.
(The manner of sitting is exhausting).
- (b) Uhlalo kwisixeko esitsha luyanyamezeleka.
(The manner of staying in the new village is endurable).

hlala (sit, stay)

F.. [Quality]:

Class 14: ubuhlali (quality of neighbourliness)

6. (a) Ubuhlali budala ubuhlobo.
(Neighbourliness creates friendship).
- (b) Ubuhlali busekelwe phantsi kokuqondana.
(Neighbourliness is based on understanding).

The deverbatives derived from the motion verb with a locative argument **hlala** can be found in almost all the specified noun classes except for noun class 6. The lexical semantic type interpretations for the deverbal nominals derived from noun classes 1 denote person, but, except for class 7, person deverbatives in other classes do not occur.

ima (stand)

A. [Person]:

Class 1: ummi (citizen, resident)

1. Ummi kumele azidle ngelizwe lakhe.
(The citizen ought to be proud of his country).

ima (stand)

B. [Result]:

Class 7: isimo (standing, condition, trail, characteristic)

2. (a) Isimo sale ndlela asikho mgangathweni.
(The condition of this road is not up to standard).
- (b) Isimo sikaZolile kwabanye abafundi siyaxhalabisa.
(The character of Zolile to other students is a cause for concern).

ima (stand)

C. [Result]:

Class 9: imo (form, shape, condition, state)

3. (a) Imo yendlela imbi.
(The condition of the road is bad).
- (b) Imo yabadlali ayikho mgangathweni.
(The shape of the players is not up to standard).

I

ima (stand)

D. [Quality]

Class 11: umo (outlook, standing)

4. (a) Umo lwesakhiwo lufuna usijonge.
(The outlook of the building requires you to look at it).

- (b) Umo lwamajoni labonakalisa ukuzinikela emsebenzini.
(The outlook of the soldiers displayed commitment in their work).

ima (stand)

E. [Quality]

Class 14: ubumo (quality outlook, standing)

5. (a) Ubumo beNtaba yeTafile buyabukeleka.
(The quality outlook of Table Mountain is a sight to behold).
- (b) Ubumo besikolo buhle.
(The quality outlook of the school is beautiful).

fika (arrive)

A. [Person]:

Class 1: umfiki (newcomer)

1. Umfiki wazazisa kubamelwane.
(The newcomer introduced himself to the neighbours)

fika (arrive)

B. [Event, Manner]:

Class 3: umfiko (arrival, way of arriving)

2. (a) Umfiko womntwana ubungalindelwanga.
(The arrival of the child was not expected).
- (b) Umfiko uthandwa kakhulu ngabafana.
(The present from someone who has arrived is liked by young men).

fika (arrive)

C. [Person]:

Class 7: isifiki (newcomer)

3. (a) Isifiki sacheba ingca.
(The newcomer cuts the grass).

- (b) Isifiki sendoda sazazisa kubahlali.
The newcomer man introduced himself to the community).
- (c) Isifiki samadoda saxhela inkomo.
(The group of newcomer men slaughtered a cow).

fika (arrive)

D. [Person]:

Class 9: imfiki (newcomer)

4. (a) Imfiki yabulisa abamelwane.
(The newcomer greeted the neighbours).
- (b) Imfiki yendoda inabafazi ababini.
(The newcomer man has two wives).
- (c) Imfiki yamadoda ibizwe yinkosi.
(The group of newcomer men has been called by the chief).

fika (arrive)

E. [Action]

Class 9: imfiko (act of arrival)

5. (a) Imfiko kaloliwe yathatha ixesha.
(The arrival of the train took some time).
- (b) Imfiko yendwendwe yayilindelwe.
(The arrival of the visitors was expected).

fika (arrive)

F. [Result]:

Class 11: ufiko (arrival)

6. (a) Ufiko lomnwana belungalindelekanga.
(The arrival of the child was not expected).
- (b) Ufiko lwamasela loyikise abahlali.
(The arrival of the thieves frightened the residents).

fika (arrive)

G. [Quality]:

Class 14: ubufiko (quality of arrival)

7. (a) Ubufiko endaweni bungakudala izihlobo.
(The quality of arrival in a place may lead to the establishment of friends).
- (b) Ubufiko bamphathela amasela.
(The quality of arrival brought him thieves).

ngena (enter)

A. [Person]:

Class 1: umngeni (entering person)

1. Umngeni wafika kungekho mntu.
(The entering person did not find anyone).

ngena (enter)

B. [Event, Manner]:

Class 3: umngeno, (entering, way of entering, right of passage)

2. (a) Umngeno wamakwenkwe uqhubeka ngomso.
(The right of passage of the boys happens tomorrow).
- (b) Umngeno kweli krotiyana ungabangela ingozi.
(The entering in this small passage could cause danger).

ngena (enter)

C. [Artifact]:

Class 6. amangeno (entrance fee)

3. (a) Amangeno kumyadala womculo yiR20.
(The entrance to the music concert is R20).
- (b) Amangeno enyukile ukususela izolo.
(The entrance fee has increased since yesterday).

ngena (enter)

D. [Person]:

Class 9: ingena (entering person)

4. (a) Ingena langena lingalindelwanga.
(The entering person entered unexpectedly).
- (b) Ingena lendoda lacela amanzi.
(The entering man asked for water).
- (c) Ingena lamadoda layitsho indlu yagcwala.
(The group of entering men filled the whole house).

ngena (enter)

E. [Result], [Event]

Class 11: ungeno (entry)

5. (a) Ungeno kweli holo luqhubeke ngasemva.
(Entry in this hall occurred at the back).
- (b) Ungeno lwabantwana ebaleni lusothusile.
(The entry of the children in the field shocked us).

ngena (enter)

F. [Culture]:

Class 11: ungeno (levirate custom)

6. (a) Ungeno lomfazi omncinci lwenziwa ngunyana omkhulu.
(The levirate custom to the younger wife was done by the eldest son).
- (b) Ungeno luphelisiwe yinkosi.
(The levirate custom has been abolished by the chief).

ngena (enter)

G. [Quality]:

Class 14: ubungeno (quality of levirate custom)

7. (a) Ubungeno obububo buxhaswa zinkosi.
(The quality levirate custom is supported by chiefs).
- (b) Ubungeno benziwa ngunyana omkhulu.
(The quality levirate custom was done by the eldest son)

sala (remain behind)

A. [Person]:

Class 1: umsali (remaining person)

1. Umsali walandela emva kwethuba.
(The remaining person followed later).

sala (remain behind)

B. [Result]:

Class 3: umsalo (remainder, left over)

2. (a) Umsalo wokutya waphiwa izinja.
(The remainder of the food was given to the dogs).
- (b) Umsalo wenyama utyiwe nguLizo.
(The remainder of the meat was eaten by Lizo).

sala (remain behind)

C. [Result]:

Class 11: usalo (remaining behind)

3. (a) Usalo lwabakhweli lwabangela umbhodamo esitishini.
(The remaining behind of the passengers created confusion at the station).
- (b) Usalo lomntwana labavuyisa.
(The remaining of the child elated them).

sala (remain behind)

D. [Quality]:

Class 14: ubusali (quality of being left behind)

4. (a) Ubusali bamshiya nesithukuthezi.
(The quality of being left behind left him lonely).
- (b) Ubusali bufanele ukuphetshwa.
(The quality of being left behind ought to be avoided).

In summary, it is clear from the above lexical semantic representation of the motion verbs with a locative argument that these verbs can be nominalised in almost all the noun classes except for noun class 6, as there is only one deverbal noun, **amangeno**, that is derived from this class in lexical schematic representation. The deverbatives in noun class 1 and 7 with the suffix **-i** denoting person have the interpretation of an individual-level nominals (ILNs). In noun class 7 denoting person the interpretation may be that of a stage-level nominals (SLNs) depending on how the deverbal noun is used. It is evident from the lexical schematic representation above that the semantic types mostly denoted by the derived deverbal nouns from this verbal class are person and quality.

4.2.6.2 The locative refers to source

The motion verbs as described by Levin in 4.2.1 can appear with a locative argument referring to source. The lexical schematic representation below demonstrates various deverbatives from the following noun classes 1, 3, 5, 7, 8, 9, 11 and 14 that are derived from various intransitive motion verbs with a locative referring to a source.

	Class 1	class 3	class 5	class 7	class 9	class 11	class 14
buya	umbuyi	umbuyo		isibuyi	imbuyo	ubuyo	ububuyo
bhaca	umbhaci	umbhaco		isibhaci	imbaci	ubhaco	ububhaci
phuma	umphumi	umphumo	iphuma	isiphumo		uphumo	ubuphumo
vela	umveli	umvelo		isiveli	imveli	uvelo	ubuvelo

In the lexical schematic representation below the various classes of the deverbal nominals derived from motion verbs where the locative refers to a source are classified in terms of semantic type, such as Person, Event, Manner of Event, Result, Action, Culture, Artifact and Quality. The categorization of each deverbal nominal class is specified by means of a binary feature (+) for the various semantic types.

Class	buya	bhaca	phuma	vela
Person				
1	+	+	+	+
5			+	
7	+	+		+
9		+		
Event, Manner of Event				
3	+	+	+	
11				+
Action				
9	+			
Result				
7			+	
11			+	
Action/Result				
3				+
Quality				
14		+	+	+
Culture				
3			+	
Cognition				
9				+

buya (return)

A. [Person]:

Class 1: umbuyi (returning person)

1. umbuyi ufike kungekho mntu.

(The returning person arrived when there was no one).

buya (return)

B. [Event], [Manner of action]

Class 3: umbuyo (returning, way of returning)

2. (a) Umbuyo wabazali uvuyise abantwana.

(The return of the parents elated the children).

(b) Umbuyo wemfuyo uphelekwe ngumalusi.

(The return of the herds of cattle was driven by the shepherd).

buya (return)

C. [Person]:

Class 7: isibuyi (returning person)

3. (a) Isibuyi safika ngemoto.
(The returning person arrived by car).
- (b) Isibuyi sendoda safuna abazali baso.
(The returning man asked for his parents).
- (c) Isibuyi samadoda sazakhela imizi.
(The group of returning men built themselves houses).

buya (return)

D. [Action]

Class 9: imbuyo (act of return)

4. (a) Imbuyo yabasebenzi sele iqalile.
(The return of the workers has started).
- (b) Imbuyo yengqele iyoyikisa.
(The return of the cold is frightening).

buya (return)

E. [Event]

Class 11: ubuyo (the return)

5. (a) Ubuyo lomntwana lwabavuyisa abazali.
(The return of the child made the parents happy).
- (b) Ubuyo lwemvula lwamazisa impahla.
(The return of the rain made the clothes wet).

buya (return)

F. [Quality]:

Class 14: ububuyo (return)

6. (a) Ububuyo emsebenzini bube namagingxi-gingxi.
(The return from work had problems).
- (b) Ububuyo ngebhasi bube mnandi.
(The return by bus was enjoyable).

bhaca (migrate)

A. [Person]:

Class 1: umbhaci (migrant)

1. Umbhaci uze eMzantsi Afrika.
(The migrant came to South Africa).

bhaca (migrate)

B. [Event]:

Class 3: umbhaco (migration, or way of migrating)

2. (a) Umbhaco wabantu usingisele eMzantsi Afrika ubukhulu becala.
(The migration of people is heading for South Africa most of the time).
- (b) Umbhaco uphenjelelwa zimeko ezinzima zokuphila.
(The migration is precipitated by difficult living circumstances).

bhaca (migrate)

C. [Person]:

Class 7: isibhaci (migrant)

3. (a) Isibhaci safika singena nto.
(The migrant arrived without anything).
- (b) Isibhaci sendoda sazifunela umsebenzi.
(The migrant man looked for work).
- (c) Isibhaci samadoda saphiwa inyama.
(The group of migrant men were given meat).

bhaca (migrate)

D. [Person]:

Class 9: imbaci (migrant)

4. (a) Imbaci yakhetha ukuhlala eMzantsi Afrika.
(The migrant chose to stay in South Africa).
- (b) Imbaci yendoda yeza nosapho lwayo.
(The migrant man brought his family).

- (c) Imbaci zamadoda zakhusela iintsapho zazo.
(The group of migrant men protected their families).

bhaca (migrate)

E. [Action], [Event]

Class 3: ubhaco (act of migration)

5. (a) Ubhaco lulawulwa liSebe lezeKhaya.
(The act of migration is controlled by the Department of Home Affairs).
- (b) Ubhaco lwenzeka ngalo lonke ixesha.
(The act of migration happens all the time).

bhaca (migrate)

F. [Quality]:

Class 14: ububhaci (quality migration)

6. (a) Ububhaci obusesikweni bukhatshwa ngamaphepha mvume angawo.
(The migration is accompanied by proper documentation).
- (b) Ububhaci bungakhokelela kubumi obuvumelekileyo.
(The migration may lead to proper citizenship).

phuma (come / go out)

A. [Person}

Class 1: umphumi (going out/ exiting person)

1. Umphumi washiya ucango luvulekile.
(The exiting person left the door open).

phuma (come / go out)

B. [Event, Manner]:

Class 3: umphumo (going/ coming out, way of going / coming out)

2. (a) Umphumo enkonzweni wathatha ixesha.
(The coming out in church took some time).
- (b) Umphumo wamakwenkwe esuthwini ubangela imivuyo.

(The coming out of the boys from the bush creates happiness).

phuma (come / go out)

C. [Person]:

Class 5: iphuma (frequently going out person)

3. (a) Iphuma laleqisa esitishini.
(The frequently going out person rushed to the station).
- (b) Iphuma lalinxibe umnqwazi.
(The frequently going out person was wearing a hat).

phuma (come / go out)

D. [Result]:

Class 7: isiphumo (outcome, results)

4. (a) Isiphumo sokungeva kwabo ibe yintolongo.
(The result of not listening was jail).
- (b) Isiphumo sokugula kwakhe yaba kukufa.
(The outcome of his sickness was death).

phuma (come / go out)

E. [Result]

Class 11: uphumo (coming out)

5. (a) Uphumo lweemviwo lwabavuyisa abafundi.
(The coming out of the results elated the students).
- (b) Uphumo lwesikolo lwandulelwa kukukhal kwentsimbi.
(The coming out of the school was preceded by the ringing of the bell).

phuma (come / go out)

F. [Quality]:

Class 14: ubuphumo (quality of return)

6. (a) Ubuphumo bomkhwetha balungiselelwa ngendlela efanelekileyo ngabazali.

(The quality return of the initiate was properly prepared by the parents).

- (b) Ubuphumo belanga beza nobushushu.

(The quality return of the sun brought warmth).

The deverbatives derived from the motion verb where the locative refers to a source can be found in almost all the specified noun classes except for noun class 5, as only one deverbal noun, **iphuma**, is derived in this noun class as shown in the above lexical schematic representation. The lexical semantic type interpretations for the deverbal nominals derived from noun classes 1, 7 and 9 denote person where the suffix is **-i**.

vela (come out)

A. [Person]:

Class 1: umveli (coming out person)

1. Umveli wabanjwa ngamapolisa.

(The coming out person was arrested by the police).

vela (come / go out)

B. [Action, Result]:

Class 3: umvelo (act of coming out)

2. (a) Umvelo emnyango wenza amasela abaleka.

(The coming out of the door caused the thieves to run away).

- (b) Umvelo wentuku woyikisa abantwana.

(The coming out of the mole frightened the children).

vela (come out)

C. [Person]:

Class 7: isiveli (coming out person)

3. (a) Isiveli sanxiba idyasi.

(The coming out person wore a coat).

- (b) Isiveli sendoda saphuma phakathi kwabafazi.

(The coming person came out amongst women).

- (c) Isiveli samadoda saphiwa inyama.

(The group of coming men was given meat).

vela (come / go out)

D. [Cognition]:

Class 9: imveli (original practice, convention, usage)

4. (a) Imveli ithi umntu obhubhileyo makangcatywe.
(Convention requires that a dead person ought to be buried).
- (b) Imveli ithi oyena mntu mkhulu nguThixo.
(Convention dictates that the super being is Jehova).

vela (come out)

E. [Event, Manner]:

Class 11: uvelo (emergence, appearance, arrival)

5. (a) Uvelo lwabo esikolweni lwathatha iyure yonke.
(Their arrival from school took an hour).
- (b) Uvelo lwenyoka loyikisa abantu.
(The emergence of the snake frightened people).

vela (come / go out)

F. [Quality]:

Class 14: ubuvelo (quality of coming out, appearance)

6. (a) Ubuvelo benyoka boyikisa umntu wonke endlwini.
(The quality appearance of the snake frightened everyone in the house).
- (b) Ubuvelo benyanga benza kwakhanya ehlathini.
(The quality appearance of the moon lit up in the forest).

In summary, it is evident from the above lexical semantic representations of the motion verbs where the locative refers to a source that these verbs can be nominalised in almost all the noun classes except for noun class 5, as there is only one deverbal noun, **iphuma**, that is derived, as shown in this class in the lexical schematic representatio The deverbatives in noun class 1, 7 and 9 with the suffix-**i** denoting person have the interpretation of an individual-level nominals (ILNs). In noun class 7 denoting person the interpretation may be that of a stage-

level nominals (SLNs) depending on how the deverbal noun is used. It is evident from the lexical schematic representation above that the semantic type mostly denoted by the derived deverbal nouns from this verbal class denotes mostly person, where the suffix is **-i**, and quality as is demonstrated above.

4.2.6.3 The locative refers to direction

The motion verbs as described by Levin in 4.2.1 can appear with a locative referring to direction. In the lexical schematic representation below demonstrates various deverbatives from the following noun classes 1, 3, 7, 9, 11 and 14 that are derived from various intransitive motion verbs with a locative referring to a source.

	Class 1	class 3	class 7	class 9	class 11	class 14
ya	umyi		isiyi			
za	umzi		isizi			
nyuka	umnyuki	umnyuko	isinyuko/i	inyuko	unyuko	ubunyuko

In the lexical schematic representation below the various classes of the deverbal nominals derived from motion verbs where the locative refers to direction are classified in terms of semantic type, such as Person, Event, Manner of Event, Result, Action, Instrument, Artifact and Quality. The categorization of each deverbal nominal class is specified by means of a binary feature (+) for the various semantic types.

Class	ya	za	nyuka
Person			
1	+	+	+
7	+	+	+
Event, Manner			
3			+
Action			
9			+
Result			
11			+
Instrument			
7			+
Artefact			
1		+	
Quality			
14			+

ya (go, proceed)

A. [Person]:

Class 1: umyi (person who goes)

1. Umyi uhambile.
(The going person left).

ya (go, proceed)

B. [Person]:

Class 7: isiyi (frequently going person)

2. Isiyi sigodukile.
(The frequently going person has left for home).

za (come, approach)

A. [Person]:

Class 1: umzi (person who comes)

1. Umzi ebelindelwe ngabantu.
(The coming person was expected by the people).

za (come, approach)

B. [Artefact]:

Class 1: umzi (household)

2. Umzi unamagumbi amane.
(The household has four rooms).

za (come, approach)

C. [Person]:

Class 7: isizi (frequently coming person)

3. Isizi sifike iphelile inyama.
(The frequently coming person arrived when the meat was finished).

nyuka (climb up, go up)

A. [Person]:

Class 1: umnyuki (climber)

1. Umnyuki uphuncuke sele ephezulu.
(The climber lost his grip while on top).

nyuka (climb up, go up)

B. [Event]:

Class 3: umnyuko (climbing up, way of climbing up)

2. (a) Umnyuko wentaba wenzeka yonke imimnyaka.
(The climbing up of the mountain occurs yearly).
- (b) Umnyuko weqhina uyadinisa.
(The climbing of a hill is tiring).

nyuka (climb up, go up)

C. Class 7: isinyuki (climber)

3. Isinyuki sanyuka sodwa intaba.
(The climber climbed the mountain alone).

nyuka (climb up, go up)

D. [Instrument]:

Class 7: isinyuko (ladder, staircase)

4. (a) Isinyuko esingaphakathi kulo mzi senziwe ngomthi.
(The staircase inside this house is made of wood).
- (b) Isinyuko seli khaya saphukile.
(The ladder of this household is broken).

nyuka (climb up, go up)

E. [Action]:

Class 9 inyuko (act of going up, going up, increase)

5. (a) Inyuko yenqwelo moya yakhawuleza.
(The take off by the aeroplane was quick).
- (b) Inyuko yavoti yakholisa amaqela ezopolitiko.

(The increase of voters satisfied the political organisations)

nyuka (climb up, go up)

F. [Result], [Event]

Class 11: unyuko (ascension, increase, climbing up)

6. (a) Unyuko lomsithusa abaninzi.
(The climbing up of the smoke shocked many).
- (b) Unyuko lwamaxabiso okutya lubangela indlala.
(The increase of food prices causes poverty).

nyuka (climb up, go up)

G. [Quality]:

Class 14: ubunyuko (quality of climbing, ascending, rising)

7. (a) Ubunyuko bomfundisi kwisikhundla enkonzweni bathatha ixesha elide.
(The quality ascending of the reverend to a high position took a long time).
- (b) Ubunyuko bomsi benza indlela ayabonakala.
(The quality rising of the smoke made the road not visible).

The deverbatives derived from the motion verb where the locative refer to direction can be found in almost all the specified noun classes for the motion verb **nyuka**. The lexical semantic type interpretation for the deverbal nominals derived from noun classes 1 and 7 denotes person where the suffix is **-i**.

In summary, it is evident from the above lexical semantic representation of motion verbs where the locative refers to direction that there are very few occurrences of these verbs. It is only the motion verb **nyuka** that can be nominalised in most of the noun classes that have been specified. The other motion verbs where the locative refers to direction, **ya** and **za**, can only be nominalised in classes 1 and 7 where they denote person respectively. The deverbatives in noun class 1 and 7 with the suffix **-i** denoting person have the interpretation of

an individual-level nominals (ILNs). In noun class 7 denoting person the interpretation may be that of a stage-level nominals (SLNs) depending on how the deverbal noun is used.

4.3 TRANSITIVE VERBS

4.3.1 Verbs of change of state

Levin (1993: 246) describes verbs of change of state as verbs that involve changes of physical state, and further states that the change of state can be brought about externally by an agent. The lexical schematic representation below demonstrates various deverbatives from the noun classes 1, 3, 7, 9, 11 and 14 that are derived from various transitive verbs of change of state.

	Class 1	class 3	class 5	class 7	class 9	class 11	class 14
phula	umphuli	umphulo	iphula	isiphuli		uphulo	ubuphulo
goba	umgobi	umgobo		isigobi	ingobi	ugobo	ubugobo
vula	umvuli	umvulo		isivuli	imvuli	uvulo	ubuvulo
vala	umvali	umvalo		isivalo	imvalo	uvalo	ubuvalo
songa	umsongi	umsongo		isisongo			

In the lexical schematic representation below the various classes of the deverbal nominals derived from the transitive verbs of change of state are classified in terms of semantic type, such as Person, Event, Manner of Event, Result, Action, Instrument and Quality. The categorization of each deverbal nominal class is specified by means of a binary feature (+) for the various semantic types.

Class	phula	goba	vula	vala	songa
Person					
1	+	+	+	+	+
5	+				
7	+	+			
9		+	+		
Event, Manner of Event					
3	+	+			
11		+		+	
Action					
11	+				
3			+	+	
9				+	
Result					
3		+			+
11			+		
Quality					
14	+	+	+	+	
Instrument					
7			+	+	

phula (break)

A. [Person]:

Class 1: umphuli (a person who breaks)

1. Umphuli wasebenza imini yonke.
(The breaking person worked the whole day).

phula (break)

B. [Event Manner]:

Class 3: umphulo (breaking, way of breaking)

2. (a) Umphulo wembodlela esitalatweni awufuneki.
(The breaking of bottles on the street is not permitted).
- (b) Umphulo weefestile zesikolo weza nesohlwayo.
(The breaking of school windows brought a sanction).

phula (break)

C. [Person]:

Class 5: iphula (a person who breaks)

3. (a) Iphula like kusasa.

(The breaking person arrived in the morning).

(b) Iphula lendoda lafuna ihamile.

(The breaking person asked for a hammer).

(c) Iphula lamadoda lafuna amazembe.

(The group of breaking men asked for axes).

phula (break)

D. [Person]:

Class 7: isiphuli (a frequently breaking person)

4. (a) Isiphuli sakhangela amakhoba.

(The frequently breaking person looked for empty bottles).

(b) Isiphuli sendoda saphumla egumbini.

(The frequently breaking man rested in the room).

(c) Isiphuli samadoda salindela iimbodlela.

(The group of frequently breaking men waited for bottles).

phula (break)

E. [Action], [Event]

Class 11: uphulo (act of breaking)

5. (a) Uphulo lweefestile lwaqhubeka ekho amapolisa.

(The breaking of windows occurred in police presence).

(b) Uphulo lomnyango lwenzeke izolo.

(The breaking of the door occurred yesterday).

phula (break)

F. [Quality]:

Class 14: ubuphulo (quality of breaking)

6. (a) Ubuphulo bezalathisi ndlela bungadala iingozi.

(The quality breaking of road signs may cause accidents).

(b) Ubuphulo bonomathotholo budala isithukuthezi.

(The quality breaking of the radio causes loneliness).

The deverbatives derived from the transitive verb of change of state **phula** can be found in almost all the specified noun classes except for noun class 9. The lexical semantic type interpretation for the deverbal nominals derived from noun classes 1, 5 and 7 denotes person. The deverbal nominals derived from the transitive verbs of change of state can be found in almost all the noun classes with some few exceptions in noun class 5 where only one deverbal noun, **iphula**, is derived.

goba (bend)

A. [Person]:

Class 1: umgobi (a person who bends)

1. Umgobi unxibe ibhulukwe emfutshane.
(The bending person is wearing short trousers).

goba (bend)

D. [Result]:

Class 3: umgobo (turn up, bend)

4. (a) Umgobo webhulukwe uyavutha.
(The turn up of the trouser is burning).
- (b) Umgobo wendlela udala ingozi ebusuku.
(The bending road causes accidents at night).

goba (bend)

B. [Person]:

Class 7: isigobi (a frequently bending person)

2. (a) Isigobi satya inyama.
(The frequently bending person ate meat).
- (b) Isigobi sendoda salandela ngasemva.
(The frequently bending person followed from behind).
- (c) Isigobi samadoda saxhela igusha.
(A group of frequently bending men slughtered a sheep).

goba (bend)

C. [Person]:

Class 9: ingobi (expert bending person)

3. (a) Ingobi yabhala incwadi.

(An expert bending person wrote a book).

- (b) Ingobi yatyala umbona emasimini.

(An expert bending person ploughed milies).

goba (Eend)

D. [Event]:

Class 11: ugobo (turn up, bend)

4. (a) Ugobo lwebhulukwe lwenziwa kakuhle.

(The turn up of the trouser was done nicely).

- (b) Ugobo lwentsimbi lwabangelwa bubushushu belanga).

(The bending of the iron rod was caused by the heat of the sun).

goba (bend)

E. [Quality]:

Class 14: ubugobo (state / quality of bending)

5. (a) Ubugobo obuhle bebhulukhwe bulungisiwe.

(The beautiful quality turn-up of the trouser has been fixed).

- (b) Ubugobo belokhwe bukrazukile.

(The quality turn up of the dress is broken).

vula (open)

A. [Person]:

Class 1: umvuli (a person who opens)

1. Umvuli utshixe ngeqhaga.

(The opening person locked with a padlock).

vula (open)

B. [Action]:

Class 3: umvulo (act of opening)

2. (a) Umvulo wetheko wenziwa nguMfundisi.

(The opening of the ceremony was done by the Reverend).

- (b) Umvulo wetyesi wavumbulula imali eninzi.
(The opening act of the suitcase resulted in the discovery of a lot of money).

vula (open)

C. [Instrument]:

Class 7: isivuli (opening instrument)

3. (a) Isivuli kulo mnyango simele ukutshintha.
(The opening instrument on this door ought to be changed).
(b) Isivuli salo mnyango silahlekile.
(The opening instrument for this door is lost).

vula (open)

D. [Person]:

Class 9: invuli (an expert opener)

4. (a) Invuli yavula kuvaliwe.
(The expert opener opened whilst it was closed).
(b) Invuli yagcina izitshixo.
(The expert opener kept the keys).

vula (open)

E. [Event]:

Class 11: uvulo (opening)

5. (a) Uvulo lweevenkile luthabatha ixesha elide ehlotyeni.
(The opening of shops takes a long time in summer).
(b) Uvulo lwetheko lwenziwa ngexesha.
(The opening ceremony happened in time).

vula (open)

F. [Quality]:

Class 14: ubuvulo (quality opening)

6. (a) Ubuvulo besango benziwe luqilima.
(The quality opening of the gate has been made strong).
- (b) Ubuvulo bomyezo buphakamile ukukhusela abantu kwizilwanyana ezinobungozi.
(The quality opening of the zoo is high to protect people from dangerous animals).

vala (close)

A. [Person]:

Class 1: umvali (closing person)

1. Umvali wavalela iimoto zingaweli umzila kaloliwe.
(The closing person stopped the cars from crossing the train level crossing).

vala (close)

B. [Action]:

Class 3: umvalo (act of closing)

2. (a) Umvalo wamashishini uphumza abasebenzi.
(The closing of the factories rests the workers).
- (b) Umvalo wesango wathintela amasela angabi nakungena.
(The closing of the entrance prohibited the thieves from entering).

vala (close)

C. [Instrument]:

Class 7: isivalo (closing instrument)

3. (a) Isivalo kwela gumbi sasiluqilima kakhulu.
(The closing instrument in that room was very strong indeed).
- (b) Isivalo somnyango saphukile.
(The closing instrument of the door is broken).

vala (close)

D. [Action]:

Class 9: imvalo (act of closing)

4. (a) Imvalo misebenzi izisa unxunguphalo kubasebenzi.
(The closing of factories brings misery to the workers).
- (b) Imvalo yeRatanga ikhathaze abantwana abaninzi.
(The closing of Ratanga worried many children).

vala (close)

E. [Event]:

Class 11: uvalo (closing)

5. (a) Uvalo lwezikolo luyathandwa ngabafundi.
(The closing of schools is liked by students).
- (b) Uvalo lwendlela lwathatha imini yonke.
(The closing of the road took the whole day).

vala (closed)

F. [Quality]:

Class 14: ubuvalo (quality closure)

6. (a) Ubuvalo obomeleleyo bathintela amasela angangeni endlwini.
(The strong quality closure prevented the thieves from entering the house).
- (b) Ubuvalo basindisa indlu kubaqhekezi.
(The quality closure spared the house from the burglars)

songa (fold)

A. [Person]:

Class 1: umsongi (a person who folds)

1. Umsongi wafaka impahla etyesini.
(The folding person packed the clothes in kist).

songa (fold)

B. [Result]:

Class 3: umsongo (bundle)

- 2 (a) Umsongo wempahla emdaka ukhutshelwe phandle.
(The bundle of dirty clothes has been placed outside).
- (b) Umsongo wempahla walahleka esikhululweni sikaloliwe.
(The bundle of clothes was lost at the train station).

songa (fold)

C. [Manner]:

Class 7: isisongo (bundle)

3. (a) Isisongo sempahla sagalelwa ngemva emotweni.
(The bundle of clothes was packed at the back of the car).
- (b) Isisongo sengubo sahlanjwa ngezandla.
(The bundle of blankets was washed by hands).

In summary, it is clear from the above lexical semantic representation of the transitive verbs of change of state that these verbs can be nominalised in almost all the noun classes except for the noun class 5 where only one deverbal noun **iphula** can be derived as specified above in the lexical schematic representation . The lexical semantic type for the deverbal nominals derived from noun class 1, 5 and 7 of transitive verbs of change of state denote a similar interpretation, person where the suffix is **-i**.

The deverbatives in noun class 1, 7 and 9 with the suffix **-i** denoting person have the interpretation of an individual-level nominals (ILNs). In noun class 7 denoting person the interpretation may be that of a stage-level nominals (SLNs) depending on how the deverbal noun is used. The deverbatives in noun class 5 denoting person have an interpretation of a stage-level nominals (SLNs). The semantic type for the deverbative nominals derived from noun class 14 denote Quality across board for all derived nominals derived from this verb class.

cula (sing)

A. [Person]:

Class 1: umculi (singer)

1. Umculi wacula kamnandi.
(The singer sang beautifully).

Class 5: icula (singer)

2. (a) Icula latsho ngomyoli umculo.
(The singer sang a melodius song).
- (b) Icula lonwabisa abantu ngomculo.
(The singer enertained the people with music).

Class 7: isiculi (frequent singer)

3. (a) Isiculi sacula ingoma emnandi.
(The frequent singer sang a song beautifully).
- (b) Isiculi sendoda sacula imini yonke.
(The frequent singing man sang the whole day).
- (c) Isiculi samadoda saphumla phandle okomzuzwana.
(The group of frequent singing men rested outside for a minute)

Class 9: inkculi (expert singer)

4. (a) Inkculi yaculela abantu kamnandi.
(The expert singer sang beautifully for the people).
- (b) Inkculi yaqhwyelwa emva kwengoma.
(The expert singer received an applause after the song).

cula (sing)

B. [Event]:

Class 3: umculo (way of singing, singing, music)

5. (a) Umculo owawuphuma kwelo holo wawumyoli.
(The singing that was coming out of that hall was harmonious).
- (b) Umculo wegospile umnandi enkonzweni.
(The gospel music is melodious in church).

cula (sing)

C. [Action, Result]:

Class 11: uculo (act of singing, singing)

6. (a) Uculo lwabantwana lwabavuyisa abazali.
(The singing of the children made the parents happy).
- (b) Uculo lwababukeli emdlalweni luyabakhuthaza abadlali.
(The singing of the spectators encourages the players).

Class 5: iculo (hymn, short song, song)

7. (a) Iculo elaculwa kumfihlo wakhe lavuselela izilonda.
(The hymn that was sung at his funeral evoked memories).
- (b) Iculo elaziwa ngumntu wonke nguhobe wesizwe.
(The song which is known by everybody is the national anthem).

The deverbatives derived from the transitive verb of creation **cula** can be found in all the specified noun classes. The lexical semantic type interpretation for the deverbal nominals derived from noun classes 1, 5, 7 and 9 denotes person. The deverbal nominals derived from the transitive verbs of creation can be found in almost all the noun classes with the exception of the noun class 5 where only two deverbal nouns, **icula / iculo**, are derived.

akha (build)

A. [Person]:

Class 1: umakhi (builder)

1. Umakhi wakha isikolo.
(The buider is building a school).

akha (build)

B. [Quality]:

Class 14: ubakhi (quality of builder)

2. (a) Ubakhi bufanele umntu okhuthelayo.
(Quality building requires a person who likes to work).

- (b) Ubakhi bendlela bufuna unonophelo.
(Quality building of a road requires precision).

chwela (carve, do woodwork)

A. [Person]:

Class 1: umchweli (wood carver, carpenter)

1. Umchweli wabumba utitshala ngomthi.
(The wood carver carved the teacher from a tree).

chwela (carve, do woodwork)

B. [Event, Manner]:

Class 3: umchwelo (carving, manner of carving)

2. (a) Umchwelo womthi wala madoda mhle.
(The tree carving of these men is beautiful).
(b) Umchwelo wafundiswa kubantwana besikolo.
(Wood carving was taught to school children).

chwela (carve, do woodwork)

C. [Instrument]:

Class 7: isichweli (instrument for carving, plane)

3. (a) Isichweli esisetyenziswa ekuchweleni sibukhali.
(The carving instrument used in carving is sharp).
(b) Isichweli siphulwe ngabantwana izolo.
(The carving instrument was broken by th children).

chwela (carve, do woodwork)

D. [Person]:

Class 9: inkweli (expert wood carver, carpenter)

4. (a) Inkweli yabonisa ngomsebenzi wayo kubakhenkethi.
(The expert wood carver displayed his work to tourists).
(b) Inkweli yathengisa uninzi lomsebenzi wayo.
(The expert wood carver sold most of his works).

chwela (carve, do woodwork)

E. [Action, Event]:

Class 11: uchwelo (carpentry, act of carving)

5. (a) Uchwelo lufanele umntu onesandla.
(Wood carving requires someone who is skillful).
- (b) Uchwelo lufundelwa iminyaka emithathu.
(Wood carving can be studied for three years).

chwela (carve, do woodwork)

F. [Quality]:

Class 14: ubuchweli (quality of carpentry / art / wood carving)

6. (a) Ubuchweli bufanele umntu owuthandayo umthi.
(The quality of wood carving requires a person who has a liking for the tree).
- (b) Ubuchweli bungamenzele imali umntu.
(The quality of art could make money for a person).

silá (brew)

A. [Person]:

Class 1: umsili (beer brewer)

1. Umsili wadidiyela utywala.
(The beer brewer started making home beer)

silá (brew)

B. [Action, Manner]:

Class 3: umsilo (brewing, way of brewing)

2. (a) Umsilo wotywala besintu ufanele ukwenziwa ngobunono.
(The brewing of African beer ought to be done with caution).
- (b) Umsilo ungcono xa usenziwa ngentseni.
(Brewing is better when it is done early in the morning).

sila (brew)

C. [Result]

Class 7: isisilo (state/ quality of beer brewing, beer)

3. (a) Isisilo esenziwe yile ntokazi sisemgangathweni.
(The beer done by this woman is up to standard).
- (b) Isisilo saselwa ngamadoda nabafazi.
(The beer was drunk by men and women).

sila (brew)

D. [Person]:

Class 9: intsili (expert beer brewer)

4. (a) Intsili yenza utywala obumnandi.
(The expert beer brewer made a tasty beer).
- (b) Intsili yangcamla umqombothi.
(The expert beer brewer tasted the beer).

sila (brew)

E. [Action], [Event]

Class 11: usilo (brew, act of brewing)

5. (a) Usilo lotywala besintu luthatha iveki yonke.
(The brewing of African beer takes a week).
- (b) Usilo luvame ukwenziwa ngabantu basetyhini.
(The brewing is often done by females).

sila (brew)

F. [Quality]:

Class 14: ubusilo (quality of brew)

6. (a) Ubusilo bumele ukwenziwa ngocoselelo.
(The quality brew ought to be done with care).
- (b) Ubusilo banxilisa amadoda ayayatheka.
(The quality brew made the men extremely drunk).

pheka (cook)

A. [Person]:

Class 1: umpheki (a cook)

1. Umpheki wapheka inyama.
(The cook cooked meat).

pheka (cook)

B. [Action, Manner]:

Class 3 : umpheko (cooking)

2. (a) Umpheko waququzelelwa ngoomama abadala.
(The cooking was organised by the old women).
- (b) Umpheko wagcina iintombi zisebenza imini yonke.
(The cooking kept the girls working the whole day).

pheka (cook)

C. [Result]:

Class 7: isipheko, (cooking, cooked food)

3. (a) Isipheko sokutya sishiye abantu bebawa.
(The cooking of food left people salivating).
- (b) Isipheko sagqibeka ngethuba elifanelekileyo.
(The cooking was completed at the right time).

pheka (cook)

D. [Person]:

Class 9: impeki (expert cook)

4. (a) Impeki yeli khaya nguZintle.
(The expert cook of this home is Zintle).
- (b) Impeki yanconywa ngokutya okumnandi.
(The expert cook was praised for his tasty food).

pheka (cook)

E. [Event, Manner]:

Class 11: upheko (cooking, way of cooking)

5. (a) Upheko lwale nyama sele luza kugqitywa.
(The cooking of the meat is near completion).
- (b) Upheko lwezibindi lwanikelwa emfaneni.

(The cooking of the livers was allocated to the young man)

pheka (cook)

F. [Quality]:

Class 14: ubupheko (quality cooking / cook)

6. (a) Ubupheko bufanele umntu okhuthuleyo.
(The quality cooking requires a person who likes to work).
- (b) Ubupheko bungenza intombi izuze ithenda.
(The quality cooking could make the girl to acquire a tender).

bhala (write)

A. [Person]:

Class 1: umbhali (a person who writes)

1. Umbhali uzuze isipho soluncwadi.
(The writer received an award for literature).

bhala (write)

B. [Result]:

Class 3: umbhalo (mark, line, written word, signature).

2. (a) Umbhalo eludongeni wenziwa ngabafundi.
(The writing on the wall was made by the students).
- (b) Umbhalo owenziwe emotweni wadala uncoliseko.
(The writing mark on the car caused dirt).

Class 7: isibhalo (written word, scripture)

3. (a) Isibhalo esingcwele siyawuphilisa umphefumlo.
(The holy scripture heals the soul).
- (b) Isibhalo sifumaneka ebhayibhileni.
(The scripture is found in the bible).

Class 9: imbali (history)

4. (a) Imbali ifundisa ngeziganeko esele zenzeka.
(History teaches about events that have passed already).

- (b) Imbali iyafundiswa esikolweni.
(History is taught at school).

bhala (write)

C. [Event]:

Class 11: ubhalo (writing)

5. (a) Ubhalo lwale ncwadi lwathatha iminyaka emibini.
(The writing of this book took two years).
(b) Ubhalo lweemviwo luqala kwiveki ezayo.
(The writing of examinations starts next week).

bhala (write)

D. [Quality]:

Class 14: ububhalo (quality of writer, writing)

6. (a) Ububhalo bufanele umntu onenyameko.
(The quality writing requires a person who has dedication).
(b) Ububhalo buyafundelwa ekholejini
(The quality writing can be studied at the college)

basa (light fire)

A. [Person]:

Class 1: umbasi (a person who lights fire)

1. Umbasi wadala umlilo omkhulu.
(The person who lighted the fire).

basa (light fire)

B. [Event], [Action]

Class 3: umbaso (lighting fire, way of lighting fire)

2. (a) Umbaso womlilo watshisa ihlathi.
(The lighting of fire burnt the forest).
(b) Umbaso ubangelwe ngumbane.
(The fire was caused by lightning).

basa (light fire)

C. [Instrument]:

Class 7: isibasi (instrument for lighting fire, stove)

3. (a) Isibasi siphelelwe ngamafutha sacima.
(The lighting instrument ran out of oil and ceased burning).
- (b) Isibasi kwaphekelwa ukutya kuso.
(The stove food was prepared in it).

Class 9: imbaso (lighting)

4. (a) Imbaso yamahlathi itshabalalise imizi.
(The lighting of forest fire destroyed houses).
- (b) Imbaso ehlathini ayivumelekanga ehlotyeni.
(The lighting in the forest is prohibited in summer).

basa (light fire)

D. [Action, Event]:

Class 11: ubaso (act of lighting fire)

5. (a) Ubaso lweenkuni lwadala umlilo omkhulu.
(The burning of firewood caused a huge fire).
- (b) Ubaso lomlilo ludala ukutsha kwamadlelo.
(The lighting of fires causes veld fires).

basa (light fire)

E. [Quality]:

Class 14: ububaso (quality of lighting)

6. (a) Ububaso bezibane benza umdlalo wabukeleka kubabukeli.
(The quality lighting of lights made the game enjoyable to the spectators).
- (b) Ububaso batshisa iimbiza zokutya.
(The quality lighting burnt the food pots).

enza (produce, make)

A. [Person]:

Class 1: umenzi (a perpetrator, person who produces)

1. Umenzi wobubi wabaleka.
(The perpetrator of evil ran away).

enza (produce, make)

B. [Action, Result]:

Class 7: isenzo (act of producing, doing)

2. (a) Isenzo sokuqhuba kakubi sabangela ingozi.
(The act of driving badly caused an accident).
- (b) Isenzo soselo tywala samfaka engozini yokutshona elwandle.
(The act of drinking alcohol led him to drown in the ocean).

Class 11: ulwenzu (act of doing / making)

3. (a) Ulwenzu lokutya lwathatha ixesha elide.
(The act of making food took a long time).
- (b) Ulwenzu lobundlobongela lwanqandwa ngamapolisa.
(The act of doing crime was stopped by the police).

xovula (knead)

A. [Person]:

Class 1: umxovuli (a person who kneads)

1. Umxovuli wenza isonka esimnandi.
(The kneading person made a delicious bread).

Class 9: inkxovuli (expert person who kneads)

2. (a) Inkxovuli yenza isonka sombhako.
(The expert kneading person baked bread).
- (b) Inkxovuli yendoda yathenga umgubo.
(The expert kneading man bought flour).
- (c) Inkxovuli yamadoda yabhaka izonka de kwasa.

(The group of expert kneading men baked bread until sunrise).

xovula (knead)

B. [Action]:

Class 3: umxovulo (act of kneading)

3. (a) Umxovulo wengubo wazishiya zicocekile.
(The kneading of blankets left them clean).
- (b) Umxovulo wesonka wadinisa amantombazana.
(kneading of dough left the girls tired).

xovula (knead)

C. [Instrument]:

Class 7: isixovulo (instrument for kneading)

4. (a) Isixovulo kwanyanzeleka silungiswe ngenxa yokonakala kwaso.
(The kneading instrument had to be fixed because it was broken).
- (b) Isixovulo saxovula intlama imini yonke.
(The kneading instrument made dough the whole day).

xovula (knead)

D. [Event, Manner]:

Class 11: uxovulo (way of kneading, kneading)

5. (a) Uxovulo lwempahla emdaka lufanele abantu abomeleleyo.
The kneading of dirty clothes ought to be done by strong people).
- (b) Uxovulo lwesonka lwenziwa kwakusasa.
(The kneading of dough occurred in the morning).

xovula (knead)

E. [Quality]

Class 14: ubuxovulo (quality of kneading)

6. (a) Ubuxovulo obenziwa ngabasebenzi benza izonka ezimnandi.
(The quality kneading done by the workers made the bread tasty).
- (b) Ubuxovulo bengubo bazishiya zicocekile.
(The quality kneading of blankets left them clean).

zoba (draw)

A. [Person]:

Class 1: umzobi (a person who draws, artist)

1. Umzobi wazoba isakhiwo sepalamente.
(The artist drew the parliament building).

Class 7: isizobi (a person who draws, artist)

2. (a) Isizobi safundisa abantwana ukuzoba.
(The artist taught the children to draw).
- (b) Isizobi sendoda sabonisa ngemizobo ezotyweyo.
(The artistic man displayed art paintings).
- (c) Isizobi samadoda samenyelwa kwiGrahamstown Arts Festival.
(The group of artistic men were invited to the Grahamstown Arts Festival).

Class 9: inzobi (expert person who draws, expert artist)

3. (a) Inzobi yafumana abaxhasi ngezimali.
(The expert artist got sponsorship).
- (b) Inzobi yayalewla ukuba izobe amalungu epalamente.
(The expert artist was commissioned to draw members of parliament).

zoba (draw)

B. [Result]:

Class 3: umzobo (drawing, mural)

4. (a) Umzobo weNtaba yeTafile mhle.
(The drawing of Table Mountain is beautiful).
- (b) Umzobo wenkululeko washiywa nguPemba.
The freedom mural was left by Pemba).

zoba (draw)

C. [Action, Result]:

Class 11: uzobo (act of drawing)

5. (a) Uzobo lwesakhiwo lwathatha ixesha elide.
(The drawing of the building took a long time).
- (b) Uzobo lwezilwanyana lwaphazanyiswa yimvula.
(The drawing of the animals was disturbed by the rain).

zoba (draw)

D. [Quality]:

Class 14: ubuzobo (quality of painting / drawing)

6. (a) Ubuzobo balo mfanekiso buthathe inyanga yonke ukwenziwa.
(The quality painting of this picture took a whole month to make).
- (b) Ubuzobo eludongeni babukwa ngabakhenkethi.
(The quality paintings were looked upon by the visitors).

In summary, it is clear from the above lexical schematic representation of the transitive verbs of creation that these verbs can be nominalised in almost all the noun classes except for the noun class 5 where only two deverbal noun **icula / iculo** can be derived as specified above in the lexical schematic representation . The lexical semantic type for the deverbal nominals derived from noun class 1, 5, 7 and 9 of transitive verbs of creation denotes a similar interpretation, person where the suffix is **-i**.

The deverbatives in noun class 1, 7 and 9 with the suffix-**i** denoting person have the interpretation of an individual-level nominals (ILNs). In noun class 7 denoting person the interpretation may be that of a stage-level nominals (SLNs) depending on how the deverbal noun is used. The deverbatives in noun class 5 denoting person have an interpretation of a stage-level nominals (SLNs). The semantic type for the deverbative nominals derived from noun class 14 denotes Quality across board for all derived nominals derived from this verb class.

4.3.3 Verbs of perception

Levin (1993 : 186) explains that the verbs of perception take the perceiver as subject and what is perceived as direct object. The lexical schematic representation below demonstrates various deverbatives from the noun classes 1, 3, 7, 9, 11 and 14 that are derived from various transitive verbs of perception.

	Class 1	class 3	class 7	class 9	class 11	class 14
bona	umboni	umbono	isiboni	imboni	ubono	ubumboni
hlola	umhloli	umhlolo umhlola	isihloli	intloli	uhlolo	ubuhlolo
qwalasela	umqwalaseli	umqwalaselo	isiqwalaseli	ingqwalasela	uqwalaselo	ubuqwalaselo
joja	umjoji	umjojo	isijoji	injoji	ujojo	ubujojo
va	umvi		isiva	imviwo	uviwo uluvo	
jonga	umjongi	umjongo	isijongo	injongo	ujongo	ubujongi
mamela	ummameli	umamelo	isimameli	imamela	umamelo	ubumamela

In the lexical schematic representation below the various sub-areas of the deverbal nominals derived from the transitive verbs of perception are classified in terms of semantic type, such as Person, Event, Manner of Event, Result, Action, Action,Result, Artefact, State and Quality. The categorization of each deverbal nominal class is specified by means of a binary feature (+)for the various semantic types.

Class	bona	hlola	qwalasela	joja	va	jonga	mamela
Person							
1	+	+	+	+	+	+	+
7	+	+	+	+		+	+
9	+	+		+			
5							+
Event, Manner of Event							
11	+			+			+
3	+	+		+			
Result							
11		+			+		
3			+			+	
9					+	+	
Action							
9			+			+	
11			+				
Quality							
14	+	+	+	+		+	+
Artefact							
7						+	
State							
7					+		

bona (see)

A. [Person]:

Class 1: umboni (a person who sees)

1. Umboni wabhaqa isela lizimele emthini.
(The seeing person discovered a thief hiding in a tree).

Class 7: isiboni (a person who sees frequently)

2. (a) Isiboni saqhuba imoto ngokufanelekileyo.
(The frequently seeing person drove a car appropriately).
- (b) Isiboni sendoda sazuzisa imbasa yokuqhuba kakuhle ezindleleni.
(The frequently seeing man received a trophy for driving appropriately on the roads).
- (c) Isiboni samadoda saseka umbutho wabaqhubi zimoto.

(The group of frequently seeing men formed an association of car drivers).

Class 9: imboni (an expert person who sees)

3. (a) Imboni yalumkisa abantu ngokuhamba ebusuku.
(The expert seeing person warned people about travelling at night).
- (b) Imboni yabona inkomo emnyameni.
(The expert seeing person saw a cow in the darkness).

bona (see)

B. [Event, Manner]:

Class 3: umbono (vision, sight, act of seeing)

4. (a) Umbono wakhe ngowokuba abantu basebenzisane.
(His vision is that people ought to work together).
- (b) Umbono owadalwa yingozi endleleni waba mbi.
(The sight caused by the accident was ugly).

[Event]

Class 11: ubono (seeing, way of seeing)

5. (a) Ubono lweenkwenkwezi lwenzeka ebusuku.
(The seeing of the stars occurred at night).
- (b) Ubono lwengozi lwamgulisa umqhubi.
(The seeing of the accident made the driver sick).

bona (see)

C. [Quality]

Class 14: ubumboni (quality of seer, vision)

6. (a) Ubumboni besanuse basindisa usapho engozini.
(The vision of soothsayer helped the family from danger).
- (b) Ubumboni bokubeka imali bamnceda ngemihla enzima.
(The vision of saving money helped him during hard times).

The deverbatives derived from the transitive verb of perception **bona** can be found in all the specified noun classes. The lexical semantic type interpretation for the deverbal nominals derived from noun classes 1, 7 and 9 denotes person. The deverbal nominals derived from the transitive verbs of perception can be found in almost all the noun classes with the exception of the noun class 3 and 14 for the verb **va** which cannot be derived from these noun classes.

hlola (look)

A. [Person]:

Class 1: umhloli (inspector, examiner)

1. Umhloli wandwendwela isikolo.
(The inspector visited the school).

Class 7: isihloli (frequent inspectors, examiners)

2. (a) Isihloli satyelela umzi wogcino zilwanyana.
(The frequent inspector visited the zoo).
- (b) Isihloli sendoda saba nomtshato omhlophe.
(The frequent inspecting man had a white wedding).
- (c) Isihloli samadoda savumela inyama ukuba ingatyiwa.
(The group of frequent inspecting men allowed that the meat be eaten).

Class 9: intloli (expert inspector / examiner / spy)

3. (a) Intloli yabona umzila wenyoka.
(The expert inspector saw the snake's track).
- (b) Intloli yoMzantsi Afrika yabanjwa eLesotho.
(The South Africa spy was arrested in Lesotho).

hlola (look)

B. [Action, Manner]:

Class 3: umhlolo (looking, way of looking)

4. (a) Umhlolo wendlela uqhubeke kakuhle.
(The inspection of the road took place well).

- (b) Umhlolo wosana ngugqira wenzeka esibheldele.
(The examining of the baby by the doctor took place in hospital).

hlola (look)

C. [Result], [Event]

Class 11: uhlolo (inspection)

5. (a) Uhlolo rhoqo lwezilwanyana luzigcina zisempilweni.
(The frequent inspection of animals keeps them healthy).
- (b) Uhlolo lweemoto lwenziwa ngamagosa endlela.
(The inspection of the cars was done by the traffic cops).

hlola (look)

D. [Quality]:

Class 14: ubuhlolo (quality of inspection)

6. (a) Ubuhlolo bomsebenzi wabafundi bunzima.
(The quality inspection of student's work is difficult).
- (b) Ubuhlolo bamanzi edama bathatha ixesha.
(The inspection of the dam water took some time).

qwalasela (observe)

A. [Person]:

Class 1: umqwalaseli (observer)

1. Umqwalaseli waphawula ukungapheleli kweegusha.
(The observer noticed the shortage of sheep).

Class 7: isiqwalaseli (frequent observer)

2. (a) Isiqwalaseli saqaphela amasela emmfuyo.
(The frequent observer noticed the stock thieves).
- (b) Isiqwalaseli sendoda satyunjelwa ubunogada.
(The frequent observing man was selected to be a guard).
- (c) Isiqwalaseli samadoda saba ngumqobo kubaqhekezi.

(The group of frequent observing men became a deterrent to burglars).

qwalasela (observe)

B. [Result]:

Class 3: umqwalaselo (observation)

3. (a) Umqwalaselo wokutsha kwemililo waba nempumelelo.
(The observation of burning veld fires was successful).
- (b) Umqwalaselo wamapolisa wakhokelela ekubanjweni kwamasele.
(The observation of the police led to the arrest of the thieves).

qwalasela (observe)

C. [Action]:

Class 9: ingqwalasela (observation, act of observing)

4. (a) Ingqwalasela kubantwana ngalo lonke ilixa ibalulekile.
(The act of observation to children at all times is important).
- (b) Ingqwalasela kumasela iwenza angonwabi.
(The observation on thieves makes them uncomfortable).

[Event]

Class 11: uqwalaselo (observation)

5. (a) Uqwalaselo lubalulekile xa uqhuba isithuthi.
(Observation is crucial when driving a car).
- (b) Uqwalaselo lwezithuthi endleleni lubalulekile.
(The observation of cars on the road is important).

qwalasela (observe)

D. [Quality]:

Class 14: ubuqwalaseli (quality of observation)

6. (a) Ubuqwalaselo basindisa abantwana enyokeni.

(The quality observation helped the children in avoiding a snake).

- (b) Ubuqwalaselo bukagqira banceda ixhego kwisigulo salo.
(The quality observation by the doctor helped the old man in his sickness).

joja (smell)

A. [Person]:

Class 1: umjoji (a person who sniffs)

1. Umjoji weva imbiza yokutya etshayo.
(The smelling person could smell the burning food pot).

Class 7: isijoji (person who frequently sniffs)

2. (a) Isijoji seva ukunuka komsi.
(The frequent sniffing person could smell the smoke).
(b) Isijoji sendoda sathimliswa lifumba elalikho.
(The frequent sniffing man sneezed as a result of the prevailing smell).
(c) Isijoji samadoda aba nokuva ukubola kwenyama.
(The group of frequent sniffing men could smell the rotten meat).

Class 9: injoji (expert person who sniffs)

3. (a) Injoji yakuva zisuka ukutya okungalunganga.
(The expert sniffing person realised soon the bad food).
(b) Injoji yajikisa amaqanda abolileyo.
(The expert sniffing person returned the rotten eggs).

joja (smell)

B. [Event]:

Class 3: umjojo (smelling, sniffing)

4. (a) Umjojo owenziwe yinja wenze sabhaqa iziyobisi..
(The sniffing made by the dog resulted in us finding the drugs).

- (b) Umjojo wadiza ukuba ikho inyama endlwini.
(The sniffing exposed that there was meat in the house).

Class 11: ujojo (smelling, sniffing)

5. (a) Ujojo lwekati luphezulu kakhulu.
(The smelling of the cat is very high).
(b) Ujojo lweziyobisi lwenziwa yinja.
(The sniffing of drugs was made by the dog).

joja (smell)

C. [Quality]:

Class 14: ubujojo (quality of smell / sniffing)

6. (a) Ubujojo benja bafumana iziyobisi ezifihlakeleyo.
(The quality sniffing of a dog was able to detect concealed drugs).
(b) Ubujojo bekati bayikhokelela empukwini.
(The quality sniffing of the cat led it to the mouse).

va (hear)

A. [State]:

Class 7: isiva (mark)

1. (a) Isiva ebusweni sabhaqisa isela emapoliseni.
(The mark on the face led to the discovery of the thief by the police).
(b) Isiva emqolo sabangelwa kukulunywa yinja.
(The mark at the back was caused by being beaten by the dog).

va (hear)

B. [Action]:

Class 9: inviwo (hearing)

3. (a) Inviwo yenyikima yabalekisa iimpuku.

(The hearing of the earthquake caused the running of the mice).

- (b) Inviwo yomyalezo yalumkisa abantu.
(The hearing of the message warned the people).

va (hear)

B. [Result]:

Class 11: uluvo (opinion, belief, view)

2. (a) Uluvo lwabantu abadala lubalekile ebantwaneni.
(The opinion of the old people is important to people).
- (b) Uluvo lwabahlali yaba kukungaguqulwa kwegama lendawo yabo.
(The opinion of the residents was not to change the name of their residential area).

jonga (look)

A. [Person]:

Class 1: umjongi (a person who looks, onlooker)

1. Umjongi wabona ukuza kololiwe.
(The onlooker saw the coming of the train).

Class 7: isijongi (a person who frequently looks)

2. (a) Isijongi saqaphela inyoka endlwini.
(The frequent onlooker observed a snake in the house).
- (b) Isijongi sendoda saphesha amahashe endleleni.
(The frequent looking man avoided the horses on the road).
- (c) Isijongi samdoda sanikwa uxanduva lokubamba abaphuli mthetho.
(The group of frequent looking men were given the task of arresting law breakers).

jonga (look)

B. [Action, Result]

Class 3: umjongo (looking)

3. (a) Umjongo macala omabini endlela xa uwela umgaqo ubalulekile.
(The looking on both sides of the road when crossing the road is important).
- (b) Umjongo wempahla ezibiweyo wabuya nelize.
(The looking for stolen clothes yielded nothing).

jonga (look)

C. [Result]:

Class 9: injongo (aim, intention)

4. (a) Injongo yalo mfundi kukuphumelela iimviwo.
(The aim of this student is to pass the examinations).
- (b) Injongo yamapolisa kukunqanda ulwaphulo mthetho.
(The aim of the police is to prevent crime).

jonga (look)

D. [Action], [Event]

Class 11: ujongo (looking after, care)

5. (a) Ujongo lwabantwana ngabazali lubakhusela ezingozini.
(The looking after the children by the parents protects them from danger).
- (b) Ujongo lubalulekile kwizilwanyana.
(Care is important to the animals).

jonga (look)

E. [Quality]:

Class 14: ubujongo (quality of vigilance)

6. (a) Ubujongo bufanele ukwenziwa ngenyameko.
(The quality vigilance ought to be done with grace).
- (b) Ubujongo bonogada bukhokelele ekubanjweni kwamasela.

(The quality vigilance of the guards led to the arrest of the thieves).

mamela (listen)

A. [Person]:

Class 1: ummameli (a person who listens, listener)

1. Ummameli waziva ingcebiso zexhego.
(The listener heard the advice of the old man).

Class 5: imamela (a person who listens, listener)

2. (a) Imamela lakuva konke okwathethwa entlanganisweni.
(The listener heard everything that was said in the meeting).
- (b) Imamela laphuma lanelisekile yingxelo eyanikezwayo nguSodolophu.
(The listener came out content with the report given by the mayor).

Class 7: isimameli (a person who frequently listens, listener)

3. (a) Isimameli sahlala phakathi kwabantu.
(The frequent listener sat amongst the people).
- (b) Isimameli sendoda sakhutshelwa ngaphandle kwentlanganiso.
(The frequent listening man was taken out of the meeting).
- (c) Isimameli samadoda saxhasa isiphakamiso sentlanganiso.
(The group of frequent listening men supported the motion of the meeting).

mamela (listen)

B. [Action, Event]:

Class 11: umamelo (listening)

4. (a) Umamelo lwabafundi lwenza baphumelela.
(The listening by the students caused them to pass).

- (b) Umamelo kumqeqeshi labanceda abadlali.
(The listening to the coach helped the players).

mamela (listen)

C. [Quality]:

Class 14: ubumamelo (quality of listening)

5. (a) Ubumamelo enkundleni bubalulekile kummangalelwa.
(The quality of listening in court is important to the accused).
- (b) Ubumamelo enkonzweni baphazanyiswa sisichotho.
(The quality of listening in church was disturbed by a thunderstorm).

In summary, it is evident from the above lexical schematic representation of the transitive verbs of perception that these verbs can be nominalised in almost all the noun classes. The lexical semantic type for the deverbal nominals derived from noun class 1, 7 and 9 of transitive verbs of perception denotes a similar interpretation, person where the suffix is **-i**. The deverbatives in noun class 1, 7 and 9 with the suffix **-i** denoting person have the interpretation of an individual-level nominals (ILNs). In noun class 7 denoting person the interpretation may be that of a stage-level nominals (SLNs) depending on how the deverbal noun is used. The semantic type for the deverbative nominals derived from noun class 14 denote Quality for all derived nominals derived from this verb class.

4.3.4 Search verbs

Levin (1993 : 199) indicates that the members of this class shows only one of the three possible patterns of argument expression available to verbs of search, the pattern where both arguments are expressed using prepositional phrases. The lexical schematic representation below demonstrates various deverbatives from the noun classes 1, 3, 7, 9, 11 and 14 that are derived from various transitive search verbs.

	Class 1	class 3	class 7	class 9	class 11	class 14
phicotha	umphicothi	umphicotho	isiphicothi	impicotho	uphicotho	ubuphicotho
funa	umfuni	umfuno	isifuni	imfuno	ufuno	ubufuno
londoloza	umlondoloji	umlondolozo	isilondoloji		ulondolozo	ubulondolozo
zungula	umzunguli	umzungulo	isizunguli	inzungulo	uzungulo	ubuzungulo

In the lexical schematic representation below the various classes of the deverbal nominals derived from the transitive search verbs that are classified in terms of semantic type, such as Person, Event, Manner, Action, Action,Result, Instrument and Quality. The categorization of each deverbal nominal class is specified by means of a binary feature (+) for the various semantic types.

Class	phicotha	funa	londoloza	zungula
Person				
1	+	+	+	+
7	+		+	+
Event				
11	+	+	+	+
Manner				
3	+	+	+	+
Action				
9	+			
Action/Result				
9		+		
Instrument				
7		+	+	
Quality				
14	+	+	+	+

phicotha (sift, examine)

A. [Person]:

Class 1: umphicothi (sifter, commentator, analyst)

- Umphicothi zindaba wavelela zonke iinkalo zezimvo.
(The analyst of the news looked at all angles of opinions).

Class 7: isiphicothi (frequent sifter / analyst)

2. (a) Isiphicothi sagxeka inqaku leendaba.
(The frequent analyst criticized a news item).
- (b) Isiphicothi sendoda sachaza uluvo lwaso.
(The frequent analysing man voiced his opinion).
- (c) Isiphicothi samadoda saphikisana ngezimvo.
(The group of frequent analysing men differed on their opinions).

phicotha (sift, examine)

B. [Action, Manner]:

Class 3: umphicotho (sifting)

3. (a) Umphicotho wengqolowa kumele wenziwe ngokukhawuleza.
(The sifting of wheat ought to be done quickly).
- (b) Umphicotho wentlabathi wenziwa ecaleni komlambo.
(The sifting of the sand happened on the banks of the river).

phicotha (sift, examine)

B. [Event]:

Class 11: uphicotho (sifting, way of sifting)

4. (a) Uphicotho lombona lungabangela umbona ococekileyo.
(The sifting of maze may lead to clean maze).
- (b) Uphicotho lwengqolowa lwenzeka ngokukhawuleza.
(The sifting of the wheat happened quickly).

phicotha (sift, examine)

C. [Action]:

Class 9: impicotho (act of sifting, sifting)

5. (a) Impicotho yomgubo yawenza wacoceka.
(The sifting of flower made it clean).
- (b) Impicotho yomngqusho yonwatyelwa ngabafazi.
(The sifting of maize was liked by the women).

phicotha (sift, examine)

D. [Quality]:

Class 14: ubuphicotho (quality of sifting)

6. (a) Ubuphicotho bendawo yogebengo lwathatha ixesha emapoliseni.
(The quality sifting of the crime scene took the police some time).
- (b) Ubuphicotho bobungqina buthathe iveki.
(The sifting of evidence took a week).

The deverbatives derived from the transitive search verb **phicotha** can be found in all the specified noun classes. The lexical semantic type interpretation for the deverbal nominals derived from noun classes 1 and 7 denote person. The deverbal nominals derived from the transitive search verbs can be found in almost all the noun classes with the exception of the noun class 9 for the verb **londoloza** which cannot occur in these noun classes.

funa (probe, look)

A. [Person]:

Class 1: umfuni (person who probes, searcher)

1. Umfuni wakhangelela imoto yakhe elahlekileyo..
(The searcher looked for his missing car).

funa (probe, look)

B. [Manner]:

Class 3: umfuno (probing, searching)

2. (a) Umfuno wamasela awukhokelanga kwisisombululo.
(The searching for the thieves did not yield any results).
- (b) umfuno wenja elahlekileyo wabuya nelize.
(the searching for the lost dog yielded nothing).

funa (probe, look)

C. [Event]:

Class 11: ufuno (probing, searching)

3. (a) Ufuno lomntwana olahlekileyo lubandakanye abahlali.

(The searching for the missing child included the residents).

- (b) Ufuno lwesikolo esitsha lube nempumelelo.
(The searching for a new school was successful).

funa (probe, look)

D. [Action, Result]:

Class 9: imfuno (act of probing, need, wish)

4. (a) Imfuno yabantwana kukutya.
(The need for the children is food).
(b) Imfuno yomzali kukuya komntwana esikolweni.
(The need by the parent is for the child to go to school).

funa (probe, look)

E. [Quality]:

Class 14: ubufuno (quality of probing)

5. (a) Ubufuno bumele ukwenziwa ngenyameko.
(The quality probing ought to be done carefully).
(b) Ubufuno babo bantu basindileyo beziwa ngokukhawuleza.
(The quality searching for the survivors was done promptly)

funa (probe, look)

F. [Instrument]:

Class 7: isifuni (instrument for looking)

6. (a) Isifuni nqwelo-moya yaseMelika asiqhutywa ngumntu.
(The American spy aeroplane is not flown by a person).
(b) Isifuni oyile sasetyenziswa elwandle.
(The oil seeking instrument was used in the ocean).

londoloza (watch, guard)

A. [Person]:

Class 1: umlondolozi (person who guards, keeper)

7. Umlondolozi zilwanyana wathatha umhlala phantsi.
(The animal keeper took retirement.)

Class 7: isilondolozi (person who guards)

8. (a) Isilondolozi sayigcina kakuhle inkomo.
(The guard kept the cow nicely).
(b) Isilondolozi sendoda sanyuselwa emsebenzini.
(The guarding man was promoted at work).
(c) isilondolozi samadoda sanikwa isipho.
(The group of guarding men were give a present).

londoloza (watch, guard)

B. [Action, Manner]:

Class 3: umlondolozo (guarding, keeping)

3. (a) Umlondolozo wezilwanyana usebenzisa imali.
(The guarding of animals leads to expenses).
(b) Umlondolozo wamahlathi ubalulekile.
(The keeping of the forest is important).

londoloza (watch, guard)

C. [Instrument]:

Class 7: isilondolozi (instrument for guarding, safe-guarding instrument)

4. (a) Isilondolozi seentuku sibambise zantathu kule veki.
(The mole instrument trapped three moles this week).
(b) Isilondolozi samanzi simele ukuhlaziywa.
(The instrument for water safe-keeping has to be renewed).

londoloza (watch, guard)

D. [Event]:

Class 11: ulondolozo (guarding, way of guarding)

5. (a) Ulondolozo lwezilwanyana ngumsebenzi onzima.
(The guarding of animals is a difficult job).
- (b) Ulondolozo lwendalo lubalulekile.
(The keeping of nature is important).

londoloza (watch, guard)

E. [Quality]:

Class 14: ubulondolozi (quality safe-keeping)

6. (a) Ubulondolozi bezilwanyana bufanele umntu onomonde.
(The quality safe-keeping of animals requires a person who is patient).
- (b) Ubulondolozi besakhiwo sesikolo busigcina sisemgangathweni.
(The quality safe keeping of the school building keeps it in pristine condition).

zungula (search, look, wish)

A. [Person]:

Class 1: umzunguli (a person who searches)

1. Umzunguli wabamba imfene.
(The searching person caught a baboon).

Class 7: isizunguli (a person who searches)

2. (a) Isizunguli saphazamisa amasela eegusha.
(The searching person disturbed sheep thieves).
- (b) Isizunguli sendoda saleqa inkawu.
(The searching man chased a monkey).
- (c) Isizunguli samadoda sakhetha ukulala emini.
(The group of searching men decided to sleep during the day).

zungula (search, look, wish)

B. [Manner]:

Class 3: umzungulo (searching)

3. (a) Umzungulo womntwana wafanela abantu abaninzi.
(The searching for the child required a lot of people).
- (b) Umzungulo wezilwanyana wathatha imini yonke.
(The searching for the animals took the whole day).

zungula (search, look, wish)

C. [Event]:

Class 11: uzungulo (way of searching)

4. (a) Uzungulo lwemali lufanele umntu okhutheloyo.
(The search for money requires an industrious person).
- (b) Uzungulo lwendoda etshone elwandle lurhoxisiwe.
(The search for the man who drowned at sea has been postponed).

zungula (search, look, wish)

D. [Action, Result]:

Class 9: inzungulo (search)

5. (a) Inzungulo yempumelelo ifuna ukusetyenzelwa.
(The search for success requires hard work).
- (b) Inzungulo yesizeka bani kokufa ibuye nelize.
(The search for the cause of death yielded nothing).

zungula (search, look, wish)

E. [Quality]:

Class 14: ubuzungulo (quality of searching, probing)

6. (a) Ubuzungulo sisenzo esithandekayo kubazingeli.
(The quality search is an admirable act to the hunters).
- (b) Ubuzungulo bezinja buvumbulule amasela ezimele.
(The quality search of the dogs uncovered hiding thieves).

In summary, it is evident from the above lexical schematic representation of the transitive search verbs that these verbs can be nominalised in almost all the noun classes except for the noun class 9 for the search verb **londoloza** as is specified above in the lexical schematic representation. The lexical semantic type for the deverbal nominals derived from noun class 1 and 7 of transitive search denotes person. The deverbatives in noun class 1 and 7 have the interpretation of an individual-level nominals (ILNs). In noun class 7 denoting person the interpretation may be that of a stage-level nominals (SLNs) depending on how the deverbal noun is used. The semantic type for the deverbative nominals derived from noun class 14 denotes Quality for all derived nominals derived from this verb class.

4.3.5 Verbs of ingesting / consumption

Levin (1993 : 213) specifies that this verb class relates to the ingestion of food and drinks. The lexical schematic representation below demonstrates various deverbatives from the following noun classes 1, 3, 5, 7, 9, 11 and 14 that are derived from various transitive verbs of ingesting / consumption.

	Class 1	class 3	class 5	class 7	class 9	class 11	class 14
ginya	umginyi	umginyo		isiginyi	inginyo	uginyo	ubuginyo
bhimbiliza	umbhimbilizi	umbhimbilizo	ibhimbiliza	isibhimbilizi		ubhimbilizo	ububhimbilizo
tya	umtyi	umtyiso		isityo / sitya	intyi	utyiwo	
hlafuna	umhlafuni	umhlafuno		isihlafuni	intlafuni / o	uhlafuno	ubuhlafuno
sela	umseli	umselo		isiselo	intseli / o	uselo	

In the lexical schematic representation below the various classes of the deverbal nominals derived from the transitive verbs of ingesting / consumption are classified in terms of semantic type, such as Person, Event, Manner of event, Action, Action,Result, Instrument and Quality. The categorization of each deverbal nominal class is specified by means of a binary feature (+) for the various semantic types.

Class	tya	bhimbiliza	ginya	hlafuna	sela
Person					
5		+			
1	+	+	+	+	+
7		+	+	+	
9	+				+
Event, Manner of event					
3		+	+	+	+
Event					
11		+	+	+	+
Result					
9				+	
7	+				+
3	+				
Result, Action					
Action					
9					+
Quality					
14		+	+	+	
7				+	
Instrument					
7	+				
9			+		

ginya (swallow)

A. [Person]:

Class 1: umginyi (a person who swallows)

1. Umginyi womiwa litapile.

(The swallowing person had a potato stuck in his throat).

Class 7: isiginyi (a person who frequently swallows)

2. (a) Isiginyi satya ngokukhawuleza.

(The frequent swallowing person ate quickly).

- (b) Isiginyi sendoda saziminca ngotywala.

(The frequent swallowing man drank alone liquor).

- (c) Isiginyi samadoda sakutya konke ukutya.

(The group of frequent swallowing men ate all the food).

ginya (swallow)

B. [Manner]:

Class 3: umginyo (swallowing)

3. (a) ULizo wawenza ngokukhawuleza umginyo.
(Lizo made the swallowing with haste).
- (b) Umginyo wabhaqisa ukuba uyatya.
(The swallowing exposed that he was eating).

ginya (swallow)

C. [Event]:

Class 11: uginyo (way of swallowing)

4. (a) Uginyo lomvubo ngabantwana yaba liphanyazo.
(The swallowing of African salad by the children happened quickly).
- (b) Uginyo lwesele yinyoka lwenzeka ngephanyazo.
(The swallowing of the frog by the snake happened very fast).

ginya (swallow)

D. [Result, Action]

Class 9: inginyo (act of swallowing, swallow)

5. (a) Inginyo yokutya okungahlafunwanga ingabangela isisu esibi.
(The swallowing of food without chewing may cause an upset stomach).
- (b) Inginyo yamaqanda yambangela ukusuza okungenakuchazwa.
(The swallowing of eggs cause him an indescribable farting).

ginya (swallow)

E. [Quality]:

Class 14: ubuginyo (quality of swallow)

6. (a) Ubuginyo babangela umntwana watsarhwa.

(The quality swallowing made the child to choke).

- (b) Ubuginyo bokutya okungahlafunwanga buyingozi.

(The quality swallowing of unchewed food is dangerous).

The deverbatives derived from the transitive ingesting verb **ginya** can be found in all the noun classes that are specified above except for noun class 5 . The lexical semantic type interpretation for the deverbal nominals derived from noun classes 1 and 7 denote person where the suffix is **-i**.

tya (eat)

A. [Person]:

Class 1: umtyi (a person who likes to eat, eater)

1. Umtyi utye yonke inyama.

(The eater ate all the meat).

Class 9: intyi (a person who likes to eat, eater)

2. (a) Intyi yazityela ukutya ingaphi mntu.

(The eater ate food without sharing with anyone).

- (b) Intyi yaziphekela intloko yehagu.

(The eater cooked for himself the pig's head).

tya (eat)

B. [Result]

Class 7: isityo (food, meal)

3. (a) Isityo sokuphela konyaka sabandakanya abasebenzi bonke.

(The end of the year meal brought all the workers together).

- (b) Isityo sithengelwe abasebenzi abalambileyo.

(The food has been bought for hungry workers).

tya (eat)

C. [Instrument]:

Class 7: isitya (dish, vessel)

4. (a) Isitya esimdaka sihlanjwe nguLinda.
(The dirty dish was washed by Linda).
- (b) Isitya sigwele ukutya.
(The dish is full of food).

bhimbiliza (gulp)

A. [Person]:

Class 1: umbhimbilizi (a person who gulps)

1. Umbhimbilizi wabusela bonke utywala bamaxhego.
(The gulping person drank all the old man's liquor).

Class 5: ibhimbiliza (gulping person)

2. Ibhimbiliza labusela bonke utywala.
(The gulping person drank all liquor).

Class 7: isibhimbilizi (a person who frequently gulps)

3. (a) Isibhimbilizi sasela umqombothi.
(The frequent gulping person drank African beer).
- (b) Isibhimbilizi sendoda sasela lonke ubisi.
(The frequent gulping man drank all the milk).
- (c) Isibhimbilizi samadoda sanikwa ikasi yotywala.
(The group of frequent gulping men were given a case of liquor).

bhimbiliza (gulp)

B. [Event, Manner]

Class 3: umbhimbilizo (way of gulping, gulping)

4. (a) Umbhimbilizo wotywala esidlangalaleni awubukeleki.
(The gulping of liquor in public is not a sight to behold).
- (b) Umbhimbilizo wamanzi uthandwa kakhulu nguThemba.

(The gulping of water is liked by Themba).

bhimbiliza (gulp)

C. [Event]:

Class 11: ubhimbilizo (gulping)

5. (a) Ubhimbilizo lotywala esidlangalaleni asinto bukekayo.
(The gulping of liquor in public is not a sight to behold).
- (b) Ubhimbilizo lweziselo lwaqhubeka emtshatweni.
(The gulping of liquids continued at the wedding).

bhimbiliza (gulp)

D. [Quality]:

Class 14: ububhimbilizo (quality of gulping)

6. (a) Ububhimbilizo bukholisa ukwenziwa zizinja xa zisela amanzi.
(The quality gulping is familiarly done by dogs when they drink water).
- (b) Ububhimbilizo botywala bunxilisa kakhulu.
(The quality gulping of liquor makes one very drunk).

hlafuna (chew)

A. [Person]:

Class 1: umhlafuni (a person who chews)

1. Umhlafuni zange akwazi nokuthetha ngumthamo.
(The chewing person could not even talk as a result of food in the mouth).

Class 7: isihlafuni (a person who frequently chews)

2. (a) Isihlafuni satya isonka.
(The frequent chewing person ate bread).
- (b) Isihlafuni sendoda sazenzela isidudu.
(The frequent chewing man made himself porridge).
- (c) Isihlafuni samadoda sahlafuna amandongomane.
(The group of frequent chewing men chewed peanuts).

Class 9: intlafuni (expert chewing person)

3. (a) Intlafuni yatya umngqusho olukhuni.
(The expert chewing person ate hard samp).
- (b) Intlafuni yatya msinyane inyama.
(The expert chewing person ate very quickly).

hlafuna (chew)

B. [Event, Manner]:

Class 3: umhlafuno (way of chewing, chewing)

4. (a) Umhlafuno wenkomo uyaphinda phinda.
(The chewing of the cow is repeated).
- (b) Umhlafuno wokutya waphelela emazinyweni.
(The miniscule food chew ended up in the teeth).

hlafuna (chew)

C. [Event]:

Class 11: uhlafuno (chewing)

5. (a) Uhlafuno lokutya lubalulekile kwimpilo yomntu.
(The chewing of food is important to a person's health).
- (b) Uhlafuno lunzima kumntu ongenamazinyo.
(The chewing is difficult to somebody who has no teeth).

hlafuna (chew)

D. [Result]

Class 9: intlafuno (chewing)

6. (a) Intlafuno inzima kubantu abangena mazinyo.
(The chewing is difficult to people who have no teeth).
- (b) Intlafuno yenziwa yinkomo xa iphumlileyo.
(The chewing is done by a cow when it is resting).

hlafuna (chew)

E. [Quality]:

Class 14: ubuhlafuno (quality of chewing)

7. (a) Ubuhlafuno bubaluleke kakhulu kwiinkomo xa zisitya.
(The quality chewing is very important to cows when they are eating).
- (b) Ubuhlafuno buyinxalenye yendlela yokutya.
(The quality of chewing is part of eating food).

sela (drink)

A. [Person]:

Class 1: umseli (a person who drinks)

1. Umseli ubanjwe ngamapolisa.
(The drinking person was arrested by the police).

Class 9: intseli (a person who drinks, expert drinker)

2. (a) Intseli yanxila imini yonke.
(The expert drinker was drunk the whole day).
- (b) Intseli yaphiwa utywala obuninzi ngabafazi.
(The expert drinker was given a lot of liquor by the women).

sela (drink)

B. [Event Manner]:

Class 3: umselo (drinking)

3. (a) Umselo wotywala mihla le awulunganga.
(The drinking of alcohol daily is not right).
- (b) Umselo wakhokelela abafundi ezunkathazweni.
(The drinking led students into trouble).

sela (drink)

C. [Result]:

Class 7: isiselo (soft/ hard drink)

4. (a) Isiselo esibandayo saluphelisa unxano.

(The soft cold drink quenched the thirst).

- (b) Isiselo sathengelwa abantwana ngumzali.

(The soft drink was bought for the children by the parent).

sela (drink)

D. [Action]

Class 9: intselo (act of drinking, drinking)

5. (a) Intselo yotywala yabandakanya notyiwo lwenyama.
(The drinking of liquor included the eating of meat).
- (b) Intselo yabangela umlo.
(The drinking caused fighting).

sela (drink)

E. [Event]:

Class 11: uselo (drinking)

6. (a) Uselo lomqombothi lwathatha imini yonke.
(The drinking of African beer took the whole day).
- (b) Uselo lweenkomo lwathatha ixesha elide.
(The drinking of cows took a long time).

In summary, it is evident from the above lexical schematic representation that the deverbal nominals derived from the transitive ingesting verbs can be found in almost all the noun classes with the exception of the noun class 5 for the verb **ginya**, **tya**, **hlafuna**, and **sela** which cannot be derived from this noun classes. The lexical semantic type for the deverbal nominals derived from noun class 1, 7 and 9 of transitive verbs of perception denotes a similar interpretation, person where the suffix is **-i**.

The deverbatives in noun class 1, 7 and 9 have the interpretation of an individual-level nominals (ILNs). In noun class 7 denoting person the interpretation may be that of a stage-level nominals (SLNs) depending on how the deverbal noun is used. The deverbatives in noun class 5 denoting person have an interpretation of a stage-level nominals (SLNs). The semantic type for the deverbative nominals derived from noun class 14 denotes Quality across board for all derived nominals derived from this verb class.

4.3.6 Verbs of cognition

According to Levin (1993: 186), verbs of cognition describe the actual perception of some entity. The lexical schematic representation below demonstrates various deverbatives from the noun classes 1, 3, 7, 9, 11 and 14 that are derived from various transitive verbs of cognition.

	Class 1	class 3	class 7	class 9	class 11	class 14
khanyela	umkhanyeli		isikhanyeli	inkanyelo	ukhanyelo	ubukhanyeli
libala	umlibali		isilibali		ulibalo	
khumbula	umkhumbuli	umkhumbulo	isikhumbuli	inkumbulo	ukhumbulo	ubukhumbulo
phazama	umphazami		isiphazami	impazamo	uphazamo	ubuphazamo
qonda	umqondi	umqondo	isiqondi	ingqondi / o	uqondo	ubuqondo
qaphela	umqapheli		isiqapheli	ingqaphelo	uqaphelo	ubuqaphelo
cinga	umcingi		isicingi	ingcinga	ucingo	
gweba	umgwebi	umgwebo	isigwebo	ingwebi	ugwebo	

In the lexical schematic representation below the various classes of the deverbal nominals derived from the transitive cognitive verbs which are classified in terms of semantic type, such as Person, Event, Action, Result and Quality. The categorization of each deverbal nominal class is specified by means of a binary feature (+) for the various semantic types.

Class	khanyela	libala	khumbula	phazama	qonda	qaphela	cinga	gweba
Person								
1	+	+	+	+	+	+	+	+
7	+	+	+	+	+	+	+	
9					+			+
Event								
11	+	+	+	+	+	+	+	+
Action, Result								
9	+		+	+	+	+	+	
3								+
7								+
Result								
3			+		+			
Quality								
14	+		+	+	+	+		

khanyela (deny)

A. [Person]:

Class 1: umkhanyeli (a person who denies)

1. Umkhanyeli wabanjwa ngamapolisa.
(The denying person was arrested by the police).

Class 7: isikhanyeli (a person who frequently denies)

2. (a) Isikhanyeli sasweleka nenyano.
(The frequent denying person died with the truth).
- (b) Isikhanyeli sendoda sabanjwa nabahlobo baso.
(The frequent denying man was arrested with his friends).
- (c) Isikhanyeli samadoda sathetha ngazwi linye.
(The group of frequent denying men spoke with one voice).

khanyela (deny)

B. [Event]:

Class 11: ukhanyelo (denying)

3. (a) Ukhanyelo lwesela lwakhohlisa amapolisa.
(The denial of the thief deceived the police).
- (b) Ukhanyelo lwesela lwalizisela iinkathazo.
(The denial of the thief brought him troubles).

khanyela (deny)

C. [Result, Action]

Class 9: inkanyelo (act of denial, denial)

4. (a) Inkanyelo yamgwebisa ngejaji.
(The denial act led to his sentencing by the judge).
- (b) Inkanyelo ya yenza indoda ayathembeka.
(The denial act made the man not to be trustworthy).

khanyela (deny)

D. [Quality]:

Class 14: ubukhanyeli (quality of denier)

5. (a) Ubukhanyeli bomoni abulunganga.
(The quality denying of wrongdoing is not right).
- (b) Ubukhanyeli benza indoda ayathembeka emsebenzini wayo.
(Quality denial made a man not to be trusted at his work).

The deverbatives derived from the transitive verb of cognition **khanyela** can be found in all the specified noun classes that are specified above except for noun class 3 . The lexical semantic type interpretation for the deverbal nominals derived from noun classes 1 and 7 denotes person where the suffix is **-i**.

libala (forget)

A. [Person]:

Class 1: umlibali (a person who forgets)

1. Umlibali washiya impahla yakhe.
(The forgetting person forgot his clothes).

Class 7: isilibali (a person who forgets frequently)

2. (a) Isilibali sashiya isitshixo semoto evenkileni.
(The forgetting person left the car keys in the shop).
- (b) Isilibali sendoda salahla isipaji saso.
(The forgetting man lost his wallet).
- (c) Isilibali samadoda satyumba umntu ebesingamfuni.
(The group of forgetting men chose someone they did not want).

libala (forget)

B. [Event]:

Class 11: ulibalo (forgetfulness)

3. (a) Ulibalo luxhaphakile kubantu abadala.
(Forgetfulness is endemic to the elderly people).

- (b) Ulibalo lwafika kuThemba kwigumbi lovavanyo.
(Forgertfulness came toThemba in the test room).

khumbula (remember)

A. [Person]:

Class 1: umkhumbuli (a person who remembers)

1. Umkhumbuli walungiselela uvulo lwezikolo.
(The remembering person made arrangements for the opening of the school).

Class 7: isikhumbuli (a person who remembers frequently)

2. (a) Isikhumbuli sakhumbuza abantwana ngoxanduva lokufunda iincwadi zabo.
(The remembering person reminded the children the task they have in reading their books).
- (b) Isikhumbuli sendoda sakhubula apho sibeke khona isitshixo.
(The remembering man remembered where he had left the keys).
- (c) Isikhumbuli samadoda saxhasa uluvo olunye.
(The group of remembering men supported one idea).

khumbula (remember)

B. [Event]:

Class 11: ukhumbulo (remembrance)

3. (a) Ukhumbulo lokufa kwabo lwabangela usizi.
(The remembrance of their death caused pity).
- (b) Ukhumbulo lwamaqhawe lwenzeka ngeyeSilimela.
(The remembrance of the heroes happens in June).

khumbula (remember)

C. [Action, Result]

Class 9: inkumbulo (act of remembering, remembrance)

4. (a) Inkumbulo yomtshato wakhe yadala uchulumanco.
(The remembering act of his wedding invoked happiness).
- (b) Inkumbulo yendoda yabangelwa kukufa kwenja.
(The remembering act of the man was caused by the death of a dog).

khumbula (remember)

D. [Result]:

Class 3: umkhumbulo (remembrance)

5. (a) Umkhumbulo wepolisa wakhokelea ekubanjweni kwamasela.
(The remembrance of the police led to the arrest of the thieves).
- (b) Umkhumbulo womalusi wakhokelela ekufumanekeni kweegusha.
(The remembrance of the shepherd led to the discovery of the sheep).

khumbula (remember)

E. [Quality]:

Class 14: ubukhumbulo (quality of memory)

6. (a) Ubukhumbulo bakhe buchaphazeleke ngenxa yokugula.
(The quality of his memory has deteriorated because of ill health).
- (b) Ubukhumbulo bakhe baphazanyiswa yingozi yemoto.
(The quality of his memory was affected by the car accident).

phazama (err)

A. [Person]:

Class 1: umphazami (a person who errs)

1. Umphazami wacela uxolo ebantwini.
(The erring person asked for forgiveness from the people).

Class 7: isiphazami (a person who frequently errs)

2. (a) Isiphazami zange sifune ngcaciso ithe vetshe ngonobangela wengozi.
(The frequently erring person did not ask for full explanation about the cause of the accident).
- (b) Isiphazami sendoda salibala ukuvala isango.
(The frequently erring man forgot to close the gate).
- (c) Isiphazami samadoda salahla imali yokuhamba.
(The group of frequently erring men lost travelling money).

phazama (err)

B. [Action, Result]:

Class 9: impazamo (error, mistake, act of erring)

3. (a) Impazamo yomfundi yalungiswa ngutitshala.
(The mistake of the student was corrected by the teacher).
- (b) Impazamo yomqhubi yabangela ingozi.
(The mistake of the driver caused an accident).

phazama (err)

C. [Event]:

Class 11: uphazamo (erring, error)

4. (a) Uphazamo olwenzekileyo lumele ukulungiswa.
(The error that has been made ought to be rectified).
- (b) Uphazamo lomqhubi lubangele ingozi.
(The error of the driver caused the accident).

phazama (err)

D. [Quality]

Class 14: ubuphazamo (quality of erring, error)

5. (a) Ubuphazamo begadi kuloliwe babangela ingozi.
(The quality error by the guard in a train resulted in an accident).
- (b) Ubuphazamo kwiimviwo kwamphosisa nganqaku.
(The quality error in the examination made him lose marks).

qonda (understand)

A. [Person]:

Class 1: umqondi (a person who understands)

1. Umqondi walandela isalathiso esimkhoba apho aya khona.
(The understanding person followed the direction leading him to where he was going).

Class 7: isiqondi (a person who easily understands)

2. (a) Isiqondi safundisa abantwana izibalo.
(The easily understanding person taught the children mathematics).
- (b) Isiqondi sendoda salondoloza imali yaso ngenyameko.
(The easily understanding man invested his money prudently).
- (c) Isiqondi samadoda savula ifektri yezihlangu.
(The group of easily understanding men opened up a shoe factory).

Class 9: ingqondi (an expert person who understands)

3. (a) Ingqondi yasombulula ingxabano yabamelwane.
(The understanding expert person resolved the neighbour's squabble).
- (b) Ingqondi yenzululwazi yafundela ubugqira.
(The scientist expert studied medicine).

qonda (understand)

B. [Result]:

Class 3: umqondo (understanding)

4. (a) Umqondo wezibalo wamenza wafundela ubunjinieli.
(The understanding of mathematics made him study engineering).
- (b) Umqondo wabafundi wenza asiphathe kakukhle isikolo.
(The understanding of students made him to manage the school well).

qonda (understand)

C. [Action, Result]

Class 9: ingqondo (act of understanding, brain)

5. (a) Ingqondo imele ukusetyenziswa xa kubhalwa iimviwo.
(The brain ought to be used when examinations are being written).
- (b) Ingqondo yemfene egulayo yahlolwa ngugqirha.
(The brain of a sick baboon was examined by the doctor).

qonda (understand)

D. [Event, Manner]:

Class 11: uqondo (understanding)

6. (a) Uqondo lomsebenzi luhambelana nokusebenza kanzima.
(The understanding of the work goes together with hard work).
- (b) Uqondo lwezibalo lwamnceda kwizifundo zobunjinieli.
(The understanding of mathematics helped him in his engineering studies).

qonda (understand)

E. [Quality]:

Class 14: ubuqondo (quality of understanding)

7. (a) Ubuqondo bakhe buphazamisekile ngenxa yengozi.
(The quality of his understanding is affected because of the accident).
- (b) Ubuqondo bomntwana bakhula ngokukhawuleza.
(The quality understanding of the child grew hastily).

qaphela (notice)

A. [Person]:

Class 1: umqapheli (a person who notices)

1. Umqapheli wabona amasela.
(The noticing person saw thieves).

Class 7: isiqapheli (a person who frequently notices)

2. (a) Isiqapheli sabona ukuzala komlambo.
(The frequently noticing person saw the fullness of the river).
- (b) Isiqapheli sendoda sakwazi ukuqaphela abasebenzi abangasebenziyo.
(The frequently noticing man was able to spot workers who were not working).
- (c) Isiqapheli samadoda saphawula umzila wengonyama.
(The group of frequently noticing men saw the tracks of a lion).

qaphela (notice)

B. [Action, Result]

Class 9: ingqaphelo (act of noticing, care, observation)

3. (a) Ingqaphelo ibalulekile xa ugcine abantwana.
(The caring is important when looking after children).

- (b) Inggaphelo yabantu abayabulayo ibalulekile kumapolisa.

(The observation of wandering people is important to the police).

qaphela (notice)

C. [Event]:

Class 11: uqaphelo (noticing, looking, awareness)

4. (a) Uqaphelo endleleni xa uqhuba isithuthi lubalulekile.
(Looking on the road when driving a car is important)
- (b) Uqaphelo endleleni lungabasindisa abantwana ezingozini.
(Awareness on the road may save the children from accidents).

qaphela (notice)

D. [Quality]:

Class 14: ubuqaphelo (quality awareness)

5. (a) Ubuqapheli bufanele umntu oneliso elibanzi.
(Quality awareness requires a person who is very sharp in observing).
- (b) Ubuqapheli bakhokelela ekubeni amapolisa abambe abaqhekezi.
(Quality awareness led the police in arresting the burglars).

cinga (think)

A. [Person]:

Class 1: umcingi (a person who thinks, thinker)

1. Umcingi waseka isikolo sabadala sangokuhlwa.
(The thinker established a night school for old people).

Class 7: isicingi (a person who always thinks)

2. (a) Isicingi saphepha imoto engaphambili ukuphepha ingozi.
(The always thinking person avoided the oncoming car to avoid an accident).
- (b) Isicingi sendoda sabiza izicimi mlilo usaqala umlilo.
(The always thinking man called fire brigades as the fire was starting).
- (c) Isicingi samadoda sangena emanzini sihlanguka umntu otshonayo.
(The group of always thinking men went into the water to save a drowning person).

cinga (think)

B. [Action, Result]

Class 9: ingcinga (act of thinking, thinking)

3. (a) Ingcinga zavuselela iinkumbulo zokulahleka kwabo.
(The thinking act brought back memories of their disappearance).
- (b) Ingcinga zebanjwa ngomzali zalenza zazihlela inyembezi.
(The thinking of the convict about his parent made the tears to flow down).

cinga (think)

C. [Event]:

Class 11: ucingo (thinking)

4. (a) Ucingo ngesisombululo sokulahleka kwabantwana lwaba nesiphumo esihle.
(The thinking about resolving the disappearance of children yielded some positive results).
- (b) Ucingo mayela nokunikwa kwamapolisa amandla athe xhaxhe ukulwa nobugebenga sele luqalile.

(The thinking concerning the allocation of more powers to the police to fight crime has started).

gweba (judge)

A. [Person]:

Class 1: umgwebi (a person who judges, arbitrator)

1. Umgwebi wagweba ngobulumko.
(The judging person arbitrated with wisdom).

Class 9: ingwebi (an expert person who judges)

2. (a) Ingwebi yamohlwaya umoni kwaxola wonke umntu.
(The expert arbitrator punished the perpetrator to the satisfaction of everybody).
- (b) Ingwebi yazuza imbasa ngenxa yemisebenzi yayo emihle.
(The expert arbitrator received a trophy because of his excellent work).

gweba (judge)

B. [Action, Result]

Class 3: umgwebo (act of judging, judgement)

3. (a) Umgwebo kungangcono ufike abantu abaninzi belele.
(The judgement day would be better if it could arrive while the people are asleep).
- (b) Umgwebo uya kufika nokuba abantu abathandi njalo.
(Judgment will arrive even if people do not like it that way).

Class 7: isigwebo (sentence)

4. (a) Isigwebo esawiswa yijaji sasimfanele.
(The sentence passed by the judge was appropriate for him).
- (b) Isigwebo asifumanayo savuyisa abaninzi.
(The sentence he received rejoiced many others).

gweba (judge)

C. [Event]:

Class 11: ugwebo (sentencing)

5. (a) Ugwebo lwamabanjwa lwenziwa ngokukhawuleza.
(The sentencing of the prisoners was done quickly).
- (b) Ugwebo lwabaphuli mthetho lwathandwa ngabantu.
(The sentencing of criminals was liked by the people).

In summary, it is evident from the above lexical semantic representation that the deverbal nominals derived from the transitive cognition verbs can be found in almost all the noun classes with the exception of the noun class 3 for the verb **khanyela** and **qaphela** which cannot be derived from this noun classes. The lexical semantic type for the deverbal nominals derived from noun class 1, 7 and 9 of transitive verbs of cognition denotes person where the suffix is **-i**. The deverbatives in noun class 1, 7 and 9 have the interpretation of an individual-level nominals (ILNs). In noun class 7 denoting person the interpretation may be that of a stage-level nominals (SLNs) depending on how the deverbal noun is used. The semantic type for the deverbative nominals derived from noun class 14 denotes Quality across board for all derived nominals derived from this verb class.

4.3.7 Contact verbs

Levin (1993 : 156) describes contact verbs as verbs that describe surface contact with no necessary implication that the contact came through impact. The lexical schematic representation below demonstrates various deverbatives from the noun classes 1, 3, 5, 7, 9, 11 and 14 that are derived from various transitive contact verbs.

	Class 1	class 3	class 5	class 7	class 9	class 11	class 14
bamba	umbambi	umbambo	ibamba	isibambi /o		ubambo	ububambo
nyumbaza	umyumbazi	umnyumbazo	inyumbaza	isinyumbazi	inyumbaza	unyumbazo	ubunyumbazo
tsweba	umtswebi	umtswebo		isitswebi	intswebi	utswebo	ubutswebo
hlukuhla	umhlukuhli	umhlukuhlo		isihlukuhli	intlukuhlo	uhlukuhlo	ubhlukuhlo
hlaba	umhlabi	umhlabo		isihlabi / isihlabo	intlabi / intlabo	uhlabo	ubuhlabo
betha	umbethi	umbetho		isibetho	imbetho/i	ubetho	ububetho
luma	umlumi	umlumo		isilumi		ulumo	ubulumo
khamba	umkhabi	umkhabo		isikhabi	inkabi	ukhabo	ubukhabo
hlasela	umhlaseli			isihlaseli	intlasele	uhlaselo	ubuhlaseli
sika	umsiki	umsiko		isisiki	intsiki	usiko	ubusiko

In the lexical schematic representation below the various classes of the deverbal nominals derived from the transitive contact verbs which are classified in terms of semantic type, such as Person, Event, Event, Manner of event, Action, Result, Result, Action, Instrument and Quality. The categorization of each deverbal nominal class is specified by means of a binary feature (+) for the various semantic types.

Class	bamba	nyumbaza	tsweba	hlukuhla	hlaba	betha	luma	khaba	hlasela	sika
Person										
1	+	+	+	+	+	+	+	+	+	+
5	+	+								
7	+	+	+	+	+		+	+	+	
9			+		+	+		+		+
Event										
11		+	+	+	+	+	+	+	+	+
Event, Manner of event										
3		+	+	+	+	+	+	+		+
Action, Result										
11	+									
Result										
3	+									
7						+				
Action										
9				+		+			+	
Instrument										
7	+				+					+
9					+					
Quality										
14	+	+	+	+	+	+	+	+	+	+

bamba (hold, catch, arrest)

A. [Person]:

Class 1: umbambi (a person who holds, acting)

1. Umbambi wesela wanconywa ngamapolisa.
(The arresting person was praised by the police).

Class 5: ibamba (place holder, deputy)

2. Ibamba – nqununu labamba iinyanga ezintathu.
(The acting principal acted for three months).

Class 7: isibambi (a person who frequently holds)

3. (a) Isibambi sayekelela kwakufika amapolisa.
(The frequently holding person loosened when the police arrived).
- (b) Isibambi sendoda sancedisa ipolisa ukubamba umgulukudu.
(The frequently holding man helped the police in arresting the criminal).
- (c) Isibambi samadoda sabamba ihashe libaleka.
(The group of frequently holding men held a running horse).

bamba (hold, catch, arrest)

B. [Result]:

Class 3: umbambo (capture)

4. (a) Umbambo wamasela wathabatha ixesha elifutshane.
(The capture of the thieves took a short while).
- (b) Umbambo wenyoka wathoba izibilini.
(The capturing of the snake relieved tension).

bamba (hold, catch, arrest)

C. [Instrument]:

Class 7: isibambo (instrument for gripping)

5. (a) Isibambo sembiza saphukile.
(The gripping handle of the pot has broken).
- (b) Isibambo sekhabhathi sawa phantsi.
(The gripping handle of the cupboard).

bamba (hold, catch, arrest)

D. [Action, Result]:

Class 11: ubambo (act of holding)

6. (a) Ubambo lwentambo lwanceda ihashe lingalahleki.
(The rope holding helped the horse not to get lost).

- (b) Ubambo lwenja lwaqhubeka imini yonke.
(The holding of the dog continued the whole day).

bamba (hold, catch, arrest)

E. [Quality]:

Class 14: ububambo (quality of the hold)

7. (a) Ububambo besango buyekeyeke.
(The quality entrance hold of the gate is weak).
(b) Ububambo bale mbiza baphukile.
(The quality hold of the pot is broken).

The deverbatives derived from the transitive contact verb **bamba** can be found in all the noun classes that are specified above except for noun class 9 . The lexical semantic type interpretations for the deverbal nominals derived from noun classes 1, 7 and 9 denote person where the suffix is **-i**.

nyumbaza (tickle)

A. [Person]:

Class 1: umnyumbazi (a person who tickles)

1. Umnyumbazi washiya abantwana behleka.
(The tickling person left the children laughing).

Class 7: isinyumbazi (a person who always tickles)

2. (a) Isinyumbazi sadlala kunye nabantwana.
(The always tickling person played with the children).
(b) Isinyumbazi sendoda siyathanda ukudlala nabantwana.
(The always tickling man likes to play with children).
(c) Isinyumbazi samadoda sapha abantwana iilekese.
(The group of always tickling men gave children sweets).

Class 5: inyumbaza (a person who tickles)

3. (a) Inyumbaza lahla phakathi kwabafazi imini yonke.
(The tickling person sat with women the whole day).

- (b) Inyumbaza lomfo lagxotshwa phakathi kwabafazi.
(The tickling man was chased away among the woman).
- (c) Inyumbaza labafo lahlala ngaphandle kwegumbi labafazi.
(The group of tickling men sat outside the women's room)

nyumbaza (tickle)

B. [Event, Manner]:

Class 3: umnyumbazo (tickling)

4. (a) Umnyumbazo wabantwana wabenza bagigitheka.
(The tickling of the children made them laugh aloud).
- (b) Umnyumbazo wonwabisa umntwana.
(The tickling made the child happy).

nyumbaza (tickle)

C. [Event]:

Class 11: unyumbazo (tickling)

4. (a) Unyumbazo lwabantwana lubenza bakhululeke.
(The tickling of children relaxes them).
- (b) Unyumbazo lwaqhubeka phakathi kwabantwana intsasa yonke.
(The tickling continued amongst the children the whole morning).

nyumbaza (tickle)

D. [Quality]

Class 14: ubunyumbazo (quality of tickling)

5. (a) Ubunyumbazo sisenzo esikhulula umzimba.
(Quality tickling relaxes the body).
- (b) Ubunyumbazo benziwa ngumzali kusana.
The quality tickling was made by the parent to the baby).

tsweba (pinch)

A. [Person]:

Class 1: umtswebi (a person who pinches)

1. Umtswebi washiya isiva emntwaneni.
(The pinching person left a mark on the child).

Class 7: isitswebi (a person who always pinches)

2. (a) Isitswebi sathembisa ngokutsweba abantwana abagezayo.
(The always pinching person promised to pinch naughty children).
- (b) Isitswebi sendoda soyikisa abantwana.
(The always pinching man made the children afraid).
- (c) Isitswebi samadoda sakhalisa abantwana.
(The group of always pinching men made the children cry).

Class 9: intswebi (expert pincher)

3. (a) Intswebi yabenza abantwana bangangcazela bakuyibona.
(The expert pinching person made the children shiver upon seeing him).
- (b) Intswebi yathembisa ngokubatsweba abantwana abangamameliyo.
(The expert pinching person promised to pinch children who did not listen).

tsweba (pinch)

B. [Event]:

Class 11: utswebo (pinching)

4. (a) Utswebo lwexhegokazi lwakhalisa abantwana.
(The pinching of the grandmother made the children to cry).

- (b) Utswebo lwabangela imikrwelo emzimbeni.
(The pinching caused marks on the body).

tsweba (pinch)

C. [Event, Manner]:

Class 3: umtswebo (pinching)

5. (a) Umtswebo washiya isiva engalweni.
(The pinching left a mark in the arm).
- (b) Umtswebo wabenza abantwana bayimamela imiyalelo yabazali.
(The pinching caused the children to listen to the parent's instructions).

tsweba (pinch)

D. [Quality]

Class 14: ubutswebo (quality of pinching)

6. (a) Ubutswebo emzimbeni bushiya isiva.
(The quality pinching leaves a mark on the body).
- (b) Ubutswebo emzimbeni buphila kade.
(The quality pinching on the body takes a long time to heal).

hlukuhla (shake)

A. [Person]:

Class 1: umhlukuhli (a person who shakes)

1. Umhlukuhli wahlukuhla imbodlela yeyeza.
(The shaking person shook medication bottle).

Class 7: isihlukuhli (a person who always shakes)

2. (a) Isihlukuhli saphakamisa ingxowa yomgubo.
(The always shaking person lifted up a sack of flour).
- (b) Isihlukuhli sendoda sadlikidla imoto ngenxa yomsindo.
(The always shaking man shook the car because of anger).

- (c) Isihlukuhli samadoda sahlukuhla ikhabhathi.
(The group of always shaking men shook the cupboard).

hlukuhla (shake)

B. [Event, Manner]

Class 3: umhlukuhlo (shaking, manner of shaking)

3. (a) Umhlukuhlo weyeza uyimfuneko phambi kokulisebenzisa.
(The shaking of the medicine is necessary before using it).
- (b) Umhlukuhlo wezindlu yinyikima wabangela zacandeka.
(The shaking of the houses by the earthquake made them to crack).

hlukuhla (shake)

C. [Action]:

Class 9: intlukuhlo (act of shaking)

4. (a) Intlukuhlo yeyeza yalenza lakulungela ukusetyenziswa.
(The shaking of medicine made it ready to be used).
- (b) Intlukuhlo yamanzi embizeni yawenza achithakala.
(The shaking of water in the pot made it to pour out).

hlukuhla (shake)

D. [Event]:

Class 11: uhlukuhlo (shaking)

5. (a) Uhlukuhlo lweyeza kakuhle phambi kokulisela luyimfuneko.
(The shaking well of medicine before drinking is a necessity).
- (b) Uhlukuhlo lwebhasi lwaboyikisa abakweli.
(The shaking of the bus made the passengers afraid).

hlukuhla (shake)

E. [Quality]:

Class 14: ubuhlukuhlo (quality of shaking, shaking)

6. (a) Ubuhlukuhlo bulenza iyeza lidibane ngendlela.
(The quality shaking makes the medicine to mix properly).
- (b) Ubuhlukuhlo bomhlaba bakhalisa abantwana.
(The quality shaking of the earth made the children to cry).

hlaba (stab)

A. [Person]:

`Class 1: umhlabi (a person who stabs)

1. Umhlabi wenja wabanjwa ngamapolisa.
(The person who stabbed a dog was arrested by the police).

Class 7: isihlabi (a person who always stabs)

2. (a) Isihlabi sabulawa ngabantu.
(The always stabbing person was killed by the community).
- (b) Isihlabi sendoda sahlaba inkomo ngemela enkulu.
(The always stabbing man stabbed a cow with a big knife).
- (c) Isihlabi samadoda saxhela inkomo.
(The group of always stabbing men slaughtered a cow).

Class 9: intlabi (a person who stabs, expert)

3. (a) Intlabi yeli khaya nguNzimande.
(The expert person who is entrusted with the killing of sacrificial animals in this household is Nzimande).
- (b) Intlabi yesixeko yabulala isela.
(The expert stabbing person of the village killed a thief).

hlaba (stab)

B. [Event, Manner]

Class 3: umhlabo (stabbing, prickle)

4. (a) Umhlabo wenkomo wenziwa ngumalume.
(The stabbing of the cow was done by my uncle).
- (b) Umhlabo wetolofiya wabangela isikhalo ebantwaneni.
(The pricking by the prickle pear caused the children to cry).

hlaba (stab)

C. [Instrument]:

Class 7: isihlabo (sharp object used for stabbing, sharp object)

5. (a) Isihlabo sekhaya kusetyenziswe sona ukuhlaba inkomo.
(The homestead instrument used for slaughtering was used to stab the cow).
- (b) Isihlabo sahlaba ivili lemoto.
(The sharp object pierced the wheel of the car).

Class 9: intlabo (sharp object used for stabbing)

6. (a) Intlabo yaphukele kwisandla sendoda.
(The sharp stabbing object broke in the man's hand).
- (b) Intlabo yekhaya igcinwa nguSizwe.
(The sharp stabbing object is kept by Sizwe).

hlaba (stab)

D. [Event]:

Class 11: uhlabo (stabbing, injection)

7. (a) Uhlabo lwenkomo lwenziwa ngobuntu lixhego.
(The stabbing of the cow was done humanely by the old man).
- (b) Uhlabo ngenaliti loyikwa ngabantu abaninzi.
(The injection by a needle is diliked by many people).

hlaba (stab)

E. [Quality]:

Class 14: ubuhlabo (quality of stabbing)

- 8 (a) Ubuhlabo bakhokelela ekubeni ixhoba linabele uqaqaqa.
(The quality stabbing led to the victim's death).
- (b) Ubuhlabo bemela bashiya inkxeba elikhulu.
(The quality stabbing of the knife left a big cut).

betha (hit)

A. [Person]:

Class 1: umbethi (a person who hits)

1. Umbethi ubizelwe kwi-ofisi yenqununu.
(The hitting person has been summoned to the principal's office).

Class 9: imbethi (expert hitting person)

2. (a) Imbethi yabanjwa ngamapolisa.
(The expert hitting person was arrested by the police).
- (b) Imbethi yagxothwa esikolweni.
(The expert hitting person was expelled at school).

betha (hit)

B. [Event Manner]

Class 3: umbetho (hitting)

3. (a) Umbetho wabantwana awufuneki ezikolweni.
(The hitting of children is not allowed at schools).
- (b) Umbetho ebantweneni ungabangela balishiye ikhaya.
(The hitting on children may lead them to run away from home).

betha (hit)

C. [Result]:

Class 7: isibetho (misfortune, calamity)

4. (a) Isibetho senkanyamba sitshabalalise imizi nemfuyo.
(The calamity of a tornado destroyed houses and livestock).
- (b) Isibetho seTsunami sashiya amawaka abantu ababhubhayo.
(The calamity of a Tsunami left thousands of people dead).

betha (hit)

D. [Action]:

Class 9: imbetho (act of hitting)

5. (a) Imbetho yabantwana yenzeka mihla yonke.
(The hitting of the children happens every day).
- (b) Imbetho yenza abantwana basonqena isikolo.
(The hitting made the children to skip school).

betha (hit)

E. [Event]:

Class 11: ubetho (hitting, ringing)

6. (a) Ubetho lwabantwana esikolweni aluvumelekanga.
(The hitting of the children with a cane is not allowed at school).
- (b) Ubetho lwentsimbi lutsho ngentsimbi yesixhenxe.
(The ringing of the bell took place at seven o' clock).

betha (hit)

F. [Quality]:

Class 14: ububetho (quality of hitting)

7. (a) Ububetho bubangela abafundi bazifunda iincwadi zabo.
(The quality hitting made students to read their books).

- (b) Ububetho entolongweni bamenza uLizo akayifuna intolongo.

(The quality beating in jail made Lizo to dislike prison).

luma (bite)

A. [Person]:

Class 1: umlumi (a biting person)

1. Umlumi waluma abahlaseli bakhe.
(The biting person bit her attackers).

Class 7: isilumi (a person who frequently bites)

2. (a) Isilumi saqhawula umnwe wesela.
(The frequently biting person severed the finger of a thief).
- (b) Isilumi sendoda satya inyama sodwa.
(The frequently biting man ate meat alone).
- (c) Isilumi samadoda sanikwa icala legusha.
(The group of frequently biting men were given a half of a sheep).

luma (bite)

B. [Event, Manner]

Class 3: umlumo (biting, bite)

3. (a) Umlumo wenkwenkwe washiya isiva kwenye.
(The bite of the boy left a mark to the other one).
- (b) Umlumo wenja washiya isiva emqolo.
(The bite of the dog left a mark on his back).

luma (bite)

C. [Event]:

Class 11: ulumo (biting, bite)

4. (a) Ulumo lwenja kakubi endodeni lwashiya inxeba.
(The biting of the dog badly on the man left a wound).

- (b) Ulumo lwenyoka lubulele indoda.
(The bite of a snake killed a man).

luma (bite)

D. [Quality]:

Class 14: ubulumo (quality of bite)

5. (a) Ubulumo bengonyama buyoyikeka.
(The quality of the bite of the lion is frightening).
(b) Ubulumo bekati bubuhlumng.
(The quality bite of the cat is painful).

khaba (kick)

A. [Person]:

Class 1: umkhabi (a person who frequently / always kicks, kicker)

1. Umkhabi waqabelisa ibhola phakathi kwempondo).
(The kicker converted the ball between the posts).

Class 7: isikhabi (a person who kicks)

2. (a) Isikhabi saphuka umlenze.
(The kicking person broke a leg).
(b) Isikhabi sendoda safakelwa isamente emlenzeni.
(The kicking man was put a plaster on the leg).
(c) Isikhabi samadoda sakhaba ibhola.
(The group of kicking men kicked the ball).

Class 9: inkabi (expert kicker)

3. (a) Inkabi yendoda yophula imbambo zenye indoda.
(The expert kicker broke the other man's rib).
(b) Inkabi yakhaba ibhola yaphumela ngaphaya kwebala.
(The expert kicker kicked the ball beyond the stadium).

khaba (kick)

B. [Event]:

Class 11: ukhabo (kicking)

4. (a) Ukhabo lwebhola wenzeka kwibala lemidlalo.
(The kicking of the ball occurred on the sports field).
- (b) Ukhabo lwehashe lwamophula ingalo.
(The kicking of the horse broke him an arm).

khaba (kick)

C. [Event, Manner]

Class 3: umkhabo (kicking)

5. (a) Umkhabo wehashe unobungozi.
(The kicking of the horse is dangerous).
- (b) Umkhabo wenciniba ebusweni ubuhlungu.
(The kicking of the Ostrich on the face is painful).

khaba (kick)

D. [Quality]:

Class 14: ubukhabo (quality of kicking)

6. (a) Ubukhabo bubalulekile kumdlalo wombhoxo.
(The quality kicking in a rugby match is important).
- (b) Ubukhabo behashe bawisa umkweli.
(The quality kicking of the horse made the rider to fall).

hlasela (attack)

A. [Person]:

Class 1: umhlaseli (a person who frequently / always attacks, attacker)

1. Umhlaseli wahlaba abantu ngomkhonto.
(The attacker stabbed the people with a spear).

Class 7: isihlaseli (a person who attacks, attacker)

2. (a) Isihlaseli sabanjwa ngamapolisa.
(The attacker was apprehended by the police).

- (b) Isihlaseli sendoda sahlutha imoto yomqhubi.
(The attacking man hijacked the car of the diver).
- (c) Isihlaseli samadoda saloyisa utshaba.
(The group of attacking men vanquished the enemy).

hlasela (attack)

B. [Action]:

Class 9: intlaselo (act of attacking)

- 3. (a) Intlaselo yamadoda yabangela aliphumelela idabi.
(The attack by the men led to them being victorious in the battle).
- (b) Intlaselo yashiya abantu abaninzi bengenazindlu e-Iraq.
(The attack left many people without houses in Iraq).

hlasela (attack)

C. [Event]:

Class 11: uhlaselo (attacking)

- 4. (a) Uhlaselo lwenziwa ngobusuku lutshaba.
(The attack was done at night by the enemy).
- (b) Uhlaselo ezinzulwini zobusuku lwashiya abantu labahlanu ababhubhileyo.
(The attack in the middle of the night left five people dead).

hlasela (attack)

D. [Quality]

Class 14: ubuhlaseli (quality of attack)

- 5. (a) Ubuhlaseli busenokuthatyathwa njengesenzo sokuzikhusela.
(The quality attack may be taken as a form of defence).
- (b) Ubuhlaseli bamakwenkwe badala impixano ekuhlaleni.
(The quality attack of the boys caused a conflict in the community).

sika (cut)

A. [Person]:

Class 1: umsiki (a person who cuts, tailor)

1. Umsiki wathunga ilokhwe yomfazi.
(The tailor sew a woman's dress).

Class 9: intsiki (a person who cuts expertly)

2. (a) Intsiki yasika imilinganiselo yempahla zabadlali.
(The cutting expert made patterns of players kit).
- (b) Intsiki yaboleka umatshini wokuthungu kummelwane.
(The cutting expert borrowed a sowing machine from a neighbour).

sika (cut)

B. [Event, Manner]

Class 3: umsiko (cutting)

3. (a) Umsiko owenziwe kule lokhwe mhle.
(The cut made on this dress is beautiful).
- (b) Umsiko umele ukwenziwa ngumthungi.
(The cut ought to be made by the tailor).

sika (cut)

C. [Instrument]

Class 7: isisiki (instrument for cutting)

4. (a) Isisiki samnqumla umlenze.
(The cutting instrument amputated his leg).
- (b) Isisiki saphulwa ngabasebenzi.
(The cutting instrument was broken by the workers).

sika (cut)

D. [Event]:

Class 11: usiko (cutting, excommunication)

5. (a) Usiko lwenyama yethoko ngumpheki lwathatha ixesha.
(The cutting of the meat for the party by the cook took some time).

- (b) Usiko lwamalungu enkonzo lwadala impixano.
(The excommunication of the church members led to a conflict).

sika (cut)

E. [Quality]

Class 14: ubusiko (quality of cutting, pattern)

6. (a) Ubusiko belokhwe bayenza yantle.
(The quality pattern of the dress made it beautiful).
(b) Ubusiko bayenza yamfutshane ibhulukwe.
(The quality cut made the trouser short).

In summary, it is clear from the above lexical semantic representation that the deverbal nominals derived from the transitive contact verbs can be found in almost all the noun classes with the exception of the noun class 3 as only the verb **bamba** and **nyumbaza** can be derived from this noun class. The lexical semantic type for the deverbal nominals derived from noun class 1, 5, 7 and 9 of the transitive contact verbs denotes person where the suffix is **-i/a**. The deverbatives in noun class 1, 5, 7 and 9 have the interpretation of an individual-level nominals (ILNs). In noun class 7 denoting person the interpretation may be that of a stage-level nominals (SLNs) depending on how the deverbal noun is used. The deverbatives in noun class 5 denoting person have an interpretation of a stage-level nominals (SLNs). The semantic type for the deverbative nominals derived from noun class 14 denotes Quality for all derived nominals derived from this verb class

4.3.8 Communication verbs

Levin (1993 : 203) cites Gropen et al (1989) in describing communication verbs as verbs of type communicated message (differentiated by something like ‘illocutionary force’). Crystal (1985 : 152) defines an illocutionary force as a term used in the theory of speech acts which is performed by the speaker by virtue of his utterance having been made. The lexical schematic representation below demonstrates various deverbatives from the noun classes 1, 3, 7, 9, 11 and 14 that are derived from various transitive communication verbs.

	Class 1	class 3	class 7	class 9	class 11	class 14
thetha	umthethi	umthetho	isithethi	intetho	uthetho	
chaza	umchazi		isichazi	inkcazo	uchazo	ubuchazi
shumayela	umshumayeli		isishumayeli	intshumayelo	ushumayelo	ubushumayeli
hlohla	umhlohli		isihlohli	intloli	uhlohlo	ubuhlohli
khwaza	Umkhwazi	umkhwazo	isikhwazi / o	inkwazo/i	ukhwazo	ubukhwazo
funda	umfundi		isifundo	imfundi	ufundo	ubufundi
xela	umxeli		isixeli	ingxelo	uxelo	ubuxelo
bika	umbiki	umbiko		imbiko	ubiko	ububiko
buza	umbuzi	umbuzo	isibuzi	imbuzo	ubuzo	ububuzo
cela	umceli		isicelo	ingcelo	ucelo	ubucelo

In the lexical schematic representation below the various classes of the deverbal nominals derived from the communication verbs which are classified in terms of semantic type, such as Person, Event, Action, Result, Instrument and Quality. The categorization of each deverbal nominal class is specified by means of a binary feature (+) for the various semantic types.

Class	thetha	chaza	shumayela	hlohla	khwaza	funda	xela	bika	buza	cela
Person										
1	+	+	+	+	+	+	+	+		+
7	+	+	+	+	+		+		+	
9				+	+	+				
Result										
3	+									
9	+	+	+			+	+	+	+	+
7	+					+				
11	+	+						+		
Event										
11			+	+	+	+	+		+	+
3							+			
9									+	
Action										
7					+					+
9					+					
Quality										
14	+	+	+	+		+	+	+	+	+
Instrument										
7					+					

thetha (speak)

A. [Person]:

Class 1: umthethi (speaker)

1. (a) Umthethi walo myalezo yaba ngunina wabantwana.
(The speaker of that message was the mother of the children).
- (b) Umthethi wenyani nguZolile.
(The speaker of the truth is Zolile).

Class 7: isithethi (frequent speaker)

2. (a) Isithethi sathatha iyure sithetha.
(The frequent speaker took an hour talking).
- (b) Isithethi sendoda sanika ingxelo mayela nokungafiki kwabadlali.
(The frequent speaking man gave a report concerning the non arrival of players).
- (c) Isithethi samadoda sifuna ukwenyuselwa imali.
(The group of frequent speaking men want a salary increase).
(The speaker of men wants a salary increase).

thetha (speak)

B. [Result]:

Class 3: umthetho (regulation, law, Act)

3. (a) Umthetho wendlela waphulwa ngabaqhubi zimoto.
(The road regulation is violated by the car drivers).
- (b) Umthetho omtsha uphunyezwe epalamente.
(The new Act has been passed by parliament).

Class 7: isithetho (lingua franca, speaking mode (channel))

4. (a) Isithetho semiguvuvela asilandeleki kakuhle.
(The lingua franca of the criminals is difficult to follow).

- (b) Isithetho sabaqhekezi samphithikeza unovenkile.
(The lingua franca of shoplifters confused the shopkeeper).

Class 9: intetho (language, talk, speech)

5. (a) Intetho kaMongameli isinike ithemba ekulweni nobundlobongela.
(The President's speech gave us hope in the fight against crime).
- (b) Intetho eninzi yabangwa lugxotho lwabasebenzi.
(A lot of talk was caused by the sacking of the workers).

[Event]

Class 11: uthetho (discussion, speech)

6. (a) Uthetho lwetyala lwamiselwa inyanga ezayo.
(The continuation of court proceedings were postponed for next month).
- (b) Uthetho lwengxaki anayo luze nesisombululo.
(The discussion of his problem brought about a reresolution).

The deverbatives from the transitive communication verb **thetha** can be found in all the noun classes that are specified above except for noun class 14 . The lexical semantic type interpretation for the deverbal nominals derived from noun classes 1, 7 and 9 denotes person where the suffix is **-i**.

chaza (explain)

A. [Person]:

Class 1: umchazi (explainer, interpreter)

1. Umchazi wachaza ngendlela ekwenzeke ngayo ingozi.
(The explainer explained the way the accident happened).

Class 7: isichazi (explainer, interpreter)

2. (a) Isichazi sanika ingcaciso ngenkqubo eza kulandelwa yovoto.
(The explainer gave an explanation concerning the method of voting that was to be followed).
- (b) Isichazi sendoda sabuzwa imibuzo ngabantu.
(The explaining man was asked questions by the people).
- (c) Isichazi samadoda zange sikwazi ukuphendula imibuzo yabantu.
(The group of explaining could not answer the questions from the people).
(The explainer of the group of men could not answer the questions from the people)

chaza (explain)

B. [Result]:

Class 9: inkcazo (explanation, way of explanation)

3. (a) Inkcazo asinike yona ngokufa kwenja akwanelisi.
(The explanation he gave about the dog's death is not convincing).
- (b) Inkcazo ngokulahleka kwabantwana yashiya isikrokro.
(The explanation about the disappearance of the children left a lot of suspicion).

[Event]

Class 11: uchazo (explanation)

3. (a) Uchazo lwenkqubo zeTV lunqongophele kumaphepha ndaba.
(The explanation of TV programmes is insufficient in newspapers).

- (b) Uchazo lokufa kwakhe lwenziwe ngamapolisa.
(The explanation of his death was made by the policemen).

chaza (explain)

C. [Quality]

Class 14: ubuchazi (quality of the explanation)

5. (a) Ubuchazi bentetho kamantyi bubalulekile enkundleni.
(The quality explanation of the magistrate's deliberations is important in court).
- (b) Ubuchazi obanikezelwa enkundleni bamanelisa umantyi.
(The quality explanation given in court satisfied the magistrate).

shumayela (preach)

A. [Person]:

Class 1: umshumayeli (preacher)

1. Umshumayeli waxelela abantu ngokubuya konyana womntu.
(The preacher told the people about the second coming of Jesus Christ).

Class 7: isishumayeli (frequent preacher)

2. (a) Isishumayeli sashumayela enkonzweni.
(The preacher preached in church).
- (b) Isishumayeli sendoda sakhetha isahluko sentshumayelo yangeCawa.
(The preaching man selected Sunday's sermon).
- (c) Isishumayeli samadoda sathandazela abantu abagulayo.
(The group of preaching men prayed for sick people).
(The preacher of men prayed for sick people).

shumayela (preach)

B. [Result]:

Class 9: intshumayelo (sermon)

3. (a) Intshumayelo yomshumayeli ibe mfutshane namhlanje.
(The preachers sermon was short today).
- (b) Intshumayelo ithandiwe libandla namhlanje.
(The sermon was liked by the congregation today).

shumayela (preach)

C. [Event]:

Class 11: ushumayelo (preaching)

4. (a) Ushumayelo luthuthuzela abo babhujelweyo.
(Preaching consoles those who have lost their loved ones).
- (b) Ushumayelo lwepasika lwenziwa yiBhishophu.
(The Good Friday sermon was made by the Bishop).

shumayela (preach)

D. [Quality]:

Class 14: ubushumayeli (quality of preaching, priesthood)

5. (a) Ubushumayeli bufuna umntu omoyikayo uThixo.
(Quality priesthood requires a God fearing person).
- (b) Ubushumayeli bomfundisi banceda abantu ngokwasemphefumleni.
(The quality preaching helped people spiritually).

funda (read)

A. [Person]:

Class 1: umfundi (a person who learns, student)

1. Umfundi wafunda incwadi zakhe.
(The student studied his books).

Class 9: imfundi (a learned person)

2. (a) Imfundi yafundisi abantwana izibalo.
(A learned person taught the children mathematics).
- (b) Imfundi yathengela abafundi iincwadi.
(The learned person bought students books).

funda (read)

B. [Result]:

Class 7: isifundo (lesson)

3. (a) Isifundo saqhubeka ekuseni.
(The lesson happened in the morning).
- (b) Isifundo senzulwazi sabavula ingqondo abafundi.
(The science lesson opened the minds of the students).

Class 9: imfundo (education)

4. (a) Imfundo ibalulekile kule mihla ikhoyo.
(Education is important these days).
- (b) Imfundo yamkhupha andlalani umfundi.
(Education took the student out of poverty).

funda (read)

C. [Event]:

Class 11: ufundo (learning)

5. (a) Ufundo lwabantwana lwaqhubeka kakuhle.
(The learning of the children went well).
- (b) Ufundo aluqhubekanga ngenxa yogwayimbo lwabasebenzi.
(The learning did not take place because of the worker' strike).

funda (read)

D. [Quality]:

Class 14: ubufundi (quality of learning)

6. (a) Ubufundi bufanele umntu ozithandayo incwadi zakhe.
(The quality learning requires a person who loves his books).
- (b) Ubufundi buhamba noxanduva kumfundi ngamnye.
(Quality learning goes with responsibility to each and every student).

hlohla (teach)

A. [Person]:

Class 1: umhlohli (teacher)

1. Umhlohli wezibalo akakho esikolweni namhlanje.
(The maths teacher is not at school today).

Class 7: isihlohli (a regular teacher)

2. (a) Isihlohli safundisa abantwana intlonipho.
(The regular teacher taught children respect).
- (b) Isihlohli sendoda siyawuthanda umsebenzi waso.
(The regular teaching man likes his work).
- (c) Isihlohli samadoda sathunyelwa kwizifundo zohlaziyo.
(The group of regular teaching men were sent to refresher courses).
(The teacher of a group of men was sent to a refresher courses).

Class 9: intlohli (expert teacher)

3. (a) Intlohli yafundisa abafundi ezembali.
(The expert teacher taught the students history).
- (b) Intlohli yahlola abafundi kwezembali.
(The expert teacher examined the students on history).

hlohla (teach)

B. [Event]:

Class 11: uhlohlo (teaching, filling)

4. (a) Uhlohlo lwabafundi lwathatha unyaka wonke.
(The teaching of the students took a year).
- (b) Uhlohlo lwempahla lwagwalisa isityesi.
(The stuffing of clothes made the kist full).

hlohla (teach)

C. [Quality]:

Class 14: ubuhlohli (quality of teaching)

5. (a) Ubuhlohli ngumsebenzi ofuna umonde.
(Quality teaching is a work that requires patience).
- (b) Ubuhlohli bezibala bufuna umntu othandayo ukubala.
(The quality teaching of mathematics requires a person who likes to count).

khwaza (shout)

A. [Person]:

Class 1: umkhwazi (a person who shouts)

1. Umkhwazi wabethela iinkomo zakhe ikhwelo.
(The shouting person blew a whistle for his cows).

Class 7: isikhwazi (a person who regularly shouts, wailer)

2. (a) Isikhwazi sabiza izinja.
(The regularly shouting person called the dogs).
- (b) Isikhwazi sendoda sahlaselwa yimigulukudu.
(The regularly shouting man was attacked by the thugs).
- (c) Isikhwazi samadoda sanyuka iqhina.
(The group of regularly shouting men went up the hill).
(The wailer of the group of men went up the hill).

Class 9: inkwazi (expert wailer)

3. (a) Inkwazi yabetha ixilongo.
(The expert wailer blew a horn).
- (b) Inkwazi yoyikisa abantwana ngengxolo.
(The expert wailer frightened the children with his noise).

khwaza (shout)

B. [Event]:

Class 3: umkhwazo (shouting)

5. (a) Umkhwazo wavusa usana lulele.
(The shouting awakened the baby in her sleep).
- (b) Umkhwazo wamabanjwa wangxolela amadindala.
(The shouting of the prisoners made noise for the prison warders).

khwaza (shout)

C. [Action]:

Class 9: inkwazo (act of shouting)

6. (a) Inkwazo ayenzayo yavakala kude.
(The shouting he made was heard far away).
- (b) Inkwazo yavusa abantu belele.
(The shouting awakened the sleeping people).

D. [Instrument]:

Class 7: isikhwazo (shouting instrument, loud hailer)

7. (a) Isikhwazo samemeza usuku lwentlanganiso.
(The shouting instrument shouted the day of the meeting).
- (b) Isikhwazo sesikolo sasetyenziswa kwezembaleki.
(The loud hailer of the school was used in an athletic meeting).

E. [Event]

Class 11: ukhwazo (shouting, noise)

8. (a) Ukhwazo lwamsindisa kwizikrelemnqa.
(The shouting saved him from hooligans).
- (b) Ukhwazo lomzali lwamenza umntwana waliva ilizwi lomzali.
(The shouting of the parent made the child to hear the voice of his mother).

xela (tell, reveal)

A. [Person]:

Class 1: umxeli (an informant)

1. Umxeli wachaza konke akubonileyo.
(The informer told everything he saw).

Class 7: isixeli (a regular informant)

2. (a) Isixeli safuna imali yaso.
(The regular informant looked for his money).
- (b) Isixeli sendoda santama amasela.
(The regular informant man exposed the thieves).
- (c) Isixeli samadoda sahlawulwa imali emfihlakalweni.
(The group of regular informant men were paid money in secret).
(The informant of the men was paid money in secret).

xela (tell, reveal)

B. [Action, Result]:

Class 9: ingxelo (report)

3. (a) Ingxelo yengozi yenziwe ngabaqhubi.
(The report of the accident was made by the drivers).
- (b) Ingxelo yonyaka yombutho yabonisa imeko embi yezimali.
(The annual report of the association showed a dire financial situation).

xela (tell, reveal)

C. [Event]:

Class 11: uxelo (reporting)

4. (a) Uxelo lwamasela lukhokelele kubanjo lwawo.
(The reporting of the thieves led to their arrest).
- (b) Uxelo lokulahleka kwabantwana lwenziwa msinyane.
(The reporting of the disappearance of the children was done promptly).

xela (tell, reveal)

D. [Quality]:

Class 14: ubuxelo (quality of reporting)

5. (a) Ubuxelo benza lula umsebenzi wamapolisa ekubambeni aboni.
(Quality reporting makes the police work easy in arresting criminals).
- (b) Ubuxelo benkanyamba ezayo boyikisa abantu.
(The quality reporting of the oncoming tornado frightened the people).

bika (make known, reveal, tell)

A. [Person]

Class 1: umbiki (a person who tells, reports, bearer)

1. Umbiki wendaba ezimbi umke izolo.
(The bearer of bad news left yesterday).

bika (make known, reveal, tell)

B. [Event]:

Class 3: umbiko (revelation)

2. (a) Umbiko wokubhubha kwakhe wothusa abantu.
(The revelation of his death shocked the people).
- (b) Umbiko wokutshona kwakhe wavakala kunomathotholo.
(The revelation of his drowning was heard over the radio).

bika (make known, reveal, tell)

C. [Result]:

Class 9: imbiko (revelation)

3. (a) Imbiko yokuzika kwabalobi yenziwa ngovelwano.
(The revelation of the drowning by the fisherman was done with empathy).
- (b) Imbiko yeziphumo zabafundi yabhengezwa kusasa.
(The revelation of the students' results was published in the morning).

bika (make known, reveal, tell)

D. [Event]:

Class 11: ubiko (announcement)

4. (a) Ubiko lwesichotho esizayo loyikisa.
(The announcement of an incoming storm was frightening).
- (b) Ubiko lwengozi lwalumkisa abaqhubi zimoto.
(The announcement of the accident warned motorists).

bika (make known, reveal, tell)

E. [Quality]:

Class 14: ububiko (quality of revelation)

5. (a) Ububiko bokutsha kwebhasi nabantwana besikolo bothusa isizwe
(The revelation quality of aburning bus with school children shocked the people).
- (b) Ububiko bokuza kwakhe ezilalini bavuyisa abantu abaninzi.
(The quality revelation of his visit to the village made a lot of people happy).

buza (ask, investigate, inquire)

A. [Person]:

Class 1: umbuzi (a person who inquires)

1. Umbuzi waphakamisa isandla efuna ukuthetha.
(The inquiring person raised his hand wanting to speak).

Class 7: isibuzi (a person who frequently asks a question)

2. (a) Isibuzi saikwa ithuba lokubuzisa umbuzo.
(The frequently inquiring person was given a chance to ask a question).
- (b) Isibuzi sendoda sabuzisa imibuzo emininzi.
(The frequently inquiring man asked a lot of questions).
- (c) Isibuzi samadoda zange sifumane mpendulo.
(The group of frequently inquiring men did not get an answer).
(The inquiring person from a group of men did not get an answer).

buza (ask, investigate, inquire)

B. [Result]:

Class 3: umbuzo (question)

3. (a) Umbuzo ngokufa kwebanjwa zange ube namphenduli.
(The question about the prisoner's death did not have a reply).
- (b) Umbuzo kamongameli wombutho wombhoxo wafumana impendulo.
(The question of the president of the ruby association received an answer).

buza (ask, investigate, inquire)

C. [Event, Action]:

Class 9: imbuzo (questioning, interrogation)

4. (a) Imbuzo zaqhubeka imini yonke kubagqatswa.
(The questioning occurred the whole day to the candidates).

- (b) Imbuzo zabenzi bobubi zenzeka intsasa yonke.
(The interrogation of bad guys occurred the whole morning).

Class 11: ubuzo (questioning)

5. (a) Ubuzo kumaphepha emviwo belungelula.
(The questioning in examination papers was not easy).
(b) Ubuzo kumaphepha emviwo belunzima.
(The questioning in examination papers was difficult).

buza (ask, investigate, inquire)

D. [Quality]:

Class 14: ububuzo (quality of questionnaire)

6. (a) Ububuzo baveza unobangela wobundlobongela.
(The quality questionnaire revealed the reasons of crime).
(b) Ububuzo bobalo luntu buthatha ixesha elide ukubugqiba.
(The quality census questionnaire took a long time to complete).

cela (ask for, apply)

A. [Person]

Class 1: umceli (a person who asks, begs)

1. Umceli wafuna imali ebantwini.
(The beggar asked for money from the people).

cela (ask for, apply)

B. [Action, Result]:

Class 7: isicelo (act of requesting, request)

2. (a) Isicelo sokuphangela emva komngcwabo siye samkelwa.
(The request to come to work after the funeral was accepted).

- (b) Isicelo sokufunda samkelwa yidyunivesithi.
(The application to study was accepted by the university).

cela (ask for, apply)

C [Result]:

Class 9: ingcelo (act of requesting)

3. (a) Ingcelo yoncedo lweencwadi yaba nempumelelo kwisikolo.
(The request for help with books yielded success to the school).
- (b) Ingcelo yokurhoxiswa kovavanyo yamkelwa ngutitshala.
(The request to postpone the tests was accepted by the teacher).

cela (ask for, apply)

D. [Event]:

Class 11: ucelo (request)

4. (a) Ucelo lokuhlangana noMphathiswa lwenziwa ngomngcelele.
(The request to meet with the Minister was done with a march).
- (b) Ucelo lokugoduka lomsebenzi lwavunyelwa ngabaqeshi.
(The request by the employee to go home was allowed by the employer).

cela (ask for, apply)

E. [Quality]:

Class 14: ubucelo (quality of requesting)

5. (a) Ubucelo boncedo ngesakhiwo senkonzo baxhaswa nguMfundisi.
(The quality request about the church building was supported by the Reverend).

- (b) Ubucelo bolungiso ndlela bamkeleka kurhulumente.
(The quality request to fix the road was accepted by the government).

In summary, it is evident from the above lexical schematic representation that the deverbal nominals derived from the communication verbs can be found in almost all the noun classes with the exception of the noun class 3 as only the verb **thetha**, **khwaza**, **bika** and **buza** can be derived from this noun class. The lexical semantic type for the deverbal nominals derived from noun class 1, 7 and 9 of the transitive contact verbs denotes person where the suffix is – i. The deverbatives in noun class 1, 7 and 9 have the interpretation of an individual-level nominals (ILNs). In noun class 7 denoting person the interpretation may be that of a stage-level nominals (SLNs) depending on how the deverbal noun is used. The semantic type for the deverbative nominals derived from noun class 14 denotes Quality for all derived nominals derived from this verb class.

4.3.9 Put verbs with a locative argument

Levin (1993 :112) claims that the verbs of putting refer to putting an entity at some location. The lexical schematic representation below demonstrates various deverbatives from the noun classes 1, 3, 7, 9, 11 and 14 that are derived from various transitive put verbs.

	Class 1	class 3	class 7	class 9	class 11	class 14
beka	umbeki	umbeko	isibeko	imbeki	ubeko	ububeko
qaba	umqabi	umqabo	isiqabi	inkqabi	uqabo	ubuqaba
tshayela	umtshayeli	umtshayelo	isitshayeli	intshayelo	utshayelo	ubuntshayelo
xhoma	umxhomi	umxhomo	Isixhomi	inkxomo	uxhomo	ubuxhomo
tshiza	umtshizi	umtshizo	isitshizi	intshizo	utshizo	ubutshizo
galela	umgaleli				ugalelo	
faka	umfaki				ufako	
thwala	umthwali	umthwalo	isithwalo	intwalo	uthwalo	
layisha	umlayishi	umlayisho	isilayisho		ulayisho	

In the lexical schematic representation below the various classes of the deverbal nominals derived from the put verbs are classified in terms of semantic type, such as Person, Event, Event, Manner of event, Action, Action, Result, Instrument, Food, Feelings, Artefact and Quality. The categorization of each deverbal nominal class is specified by means of a binary feature (+) for the various semantic types.

Class	beka	qaba	tshayela	xhoma	tshiza	galela	faka	thwala	layisha
Person									
1	+	+	+	+	+	+	+	+	+
7		+	+	+					
9	+	+							
Event									
11	+	+	+	+	+	+	+	+	+
3		+							
Event, Manner of event									
3				+					+
Result									
3	+							+	
7	+								
Action									
9			+					+	
Action, Result									
9				+	+				
Instrument									
3			+						
7					+				+
Food									
3	+								
Feelings									
7	+								
Quality									
14	+	+	+	+	+				
Artefact									
7								+	

beka (put)

A. [Person]:

Class 1: umbeki (a person who situates)

1. Umbeki nkokheli wafumana inkxaso ebantwini abadala.
(The installer of the leader received support from the old people).

Class 9: imbeki (a person who expertly puts, drafter)

2. (a) Imbeki nkokheli yagxekwa ngokungaqhakamshelani nabantu.
(The installer of the leader was villified for not consulting the people).
- (b) Imbeki mthetho yeza nemithetho emininzi.

(The legislation drafter brought a number of laws).

beka (put)

B. [Action]:

Class 3: umbeko (packing, placement).

3. (a) Umbeko weenkokheli wacaphukisa abantu.
(The placement of leaders aggrieved the people).
- (b) Umbeko wamaqanda ufanele ukwenziwa ngenyameko.
(The packing of eggs ought to be done carefully).

beka (put)

B. [Result]

Class 3: umbeko (placement, laying down, left overs)

4. (a) Umbeko watyiwa ngabantwana kusasa.
(The left overs were eaten by the children in the morning).
- (b) Umbeko phantsi wezigalo wazisa uxolo
(The laying down of weapons brought peace).

C. [Result]

Class 7: isibeko (setting aside, giving)

5. (a) Isibeko somhla womgwebo asinakujika.
(The setting aside of the day of judgment will not change).
- (b) Isibeko sengxelo yonyaka savumbulula ubuqhetseba.
(The giving of the annual report exposed a lot of corruption).

beka (put)

D. [Event]:

Class 11: ubeko (inauguration, enthronement, laying down)

6. (a) Ubeko lwenkosi esihlalweni lwaqhubeka ngendlela.
(The inauguration of the chief on the throne occurred properly).

- (b) Ubeko phantsi lwezixhobo lwaxhaswa ngabantu abaninzi.
(The laying down of arms was supported by many people).

beka (put)

E. [Quality]:

Class 14: ububeko (quality of enthronement)

7. (a) Ububeko beKumkani bathatha imini yonke.
(The enthronement of the King took the whole day).
(b) Ububeko benqununu bathandwa ngabahlali.
(The inauguration of the principal was liked by the people).

The deverbatives derived from the put verb **beka** can be found in all the noun classes that are shown above. The lexical semantic type interpretations for the deverbal nominals derived from noun classes 1, 7 and 9 denotes person where the suffix is **-i**.

qaba (smear)

A. [Person]:

Class 1: umqabi (a person who smears)

1. (a) Umqabi wembola wenza umhombiso omhle ebusweni.
(The person who applied clay on the face made a beautiful sign on the face).

Class 7: isiqabi (a person who regularly smears)

2. (a) Isiqabi sasinda umgangatho ngobulongwe.
(The regularly smearing person polished the house with cow dung).
(b) Isiqabi somfazi sashiya ubuso obuhonjisiweyo.
(The frequent clay smearing woman left a decorated face).
(c) Isiqabi sabafazi sanxiba imibhaco.

(The group of frequent clay smearing women wore traditional dresses).

Class 9: inkqabi (a person who smears expertly)

3. (a) Inkqabi yabakhwetha yaqala ngokubayala ngobudoda.
(The expert smearing the initiates with fat began by advising them about manhood).
- (b) Inkqabi bulongwe yenza igumbi lanuka kamnandi.
(The expert smearing dung person made the room smell nice).

qaba (smear)

B. [Action]:

Class 3: umqabo (smearing)

4. (a) Umqabo webhotolo wenziwa kubakhwetha abagoduswayo.
(The smearing of butter is done to initiates who are going home).
- (b) Umqabo webhotolo kubakhwetha wenziwa ngokukhawuleza.
(The smearing of butter to the initiates happened quickly).

Class 11: uqabo (smearing)

5. (a) Uqabo lwembola ebusweni luthandwa ngomama.
(The smearing of the clay on the face is liked by women).
- (b) Uqabo lwamafutha entloko lwenza iinwele zibukeke.
(The smearing of ointment on the head makes hair beautiful).

qaba (smear)

C. [State]:

Class 14: ubuqaba (traditional mode of life (idiomatic))

6. (a) Ubuqaba ububonakalise kwisinxibo sakhe.
(The traditional way of life showed in his attire).
- (b) Ubuqaba bamenza akakhathalela kunxiba zihlangu.
(The traditional way of life made him not to bother in wearing shoes).

tshayela (sweep)

A. [Person]:

Class 1: umtshayeli (a person who sweeps)

1. Umtshayeli washiya umgangatho ucocekile.
(The sweeper left the floor clean).

Class 7: isitshayeli (a frequently sweeping person)

2. (a) Isitshayeli sathatha umtshayelo egumbini.
(The frequent sweeper took a broom in the room).
- (b) Isitshayeli sendoda sachola amaphepha esitratweni.
(The frequent sweeping man picked up papers in the street).
- (c) Isitshayeli samadoda satshayela igaraji emva kwemini.
(The group of frequent sweeping men swept the garage in the afternoon).

tshayela (sweep)

B. [Instrument]:

Class 3: umtshayelo (instrument for sweeping, broom)

3. (a) Umtshayelo wanyathelwa yimoto esitratweni.
(The broom was crushed in the street by the car).
- (b) Umtshayelo othengiweyo sele ulahlekile.
(The broom that has been bought has disappeared).

tshayela (sweep)

C. [Action]

Class 9: intshayelo (act of sweeping)

4. (a) Intshayelo yegumbi imele ukwenzeka yonke imihla esikolweni.

(The sweeping of the room ought to occur on a daily basis at school).

- (b) Intshayelo esikolweni yenziwa ngamantombazana.

(The sweeping at school was done by the girls).

tshayela (sweep)

D. [Event]:

Class 11: utshayelo (sweeping)

5. (a) Utshayelo lomgangatho lwenziwa rhoqo ngabantwana besikolo.

(The sweeping of the floor is done frequently by the school children).

- (b) Utshayelo lwendlu lwayenza yacoceka.

(The sweeping of the house left it clean).

tshayela (sweep)

E. [Quality]:

Class 14: ubuntshayelo (quality of sweeping)

6. (a) Ubuntshayelo sisenzo esifuna ucocelelo.

(The quality sweeping is an act that requires care).

- (b) Ubuntshayelo bagcina igumbi licocekile esikolweni.

(The quality sweeping kept the room clean at school).

xhoma (hang)

A. [Person]:

Class 1: umxhomi (a person who hangs)

1. Umxhomi-mpahla waneka impahla phandle.

(The person hanging the clothes hung up the clothes outside).

Class 7: isixhomi (a person who hangs regularly / frequently)

2. (a) Isixhomi sabakhuphela bucala abantu abaza kuxhonywa.

(The hang man put aside the people who were going to be hanged).

(b) Isixhomi sendoda saxhoma igusha emthini.

(The hanging man hung the sheep on the tree).

(c) Isixhomi samadoda saqokelela amabanjwa aza kuxhonywa.

(The group of hanging men gathered the prisoners who are going to be hanged).

xhoma (hang)

B. [Event, Manner]:

Class 3: umxhomo (way of hanging, hanging)

3. (a) Umxhomo wamabanjwa wapheliswa eMzantsi Afrika.

(The hanging of prisoners was abolished in South Africa).

(b) Umxhomo wempahla wacina abafazi emizini.

(The hanging of the clothes kept the women in the houses).

xhoma (hang)

C. [Action, Result]

Class 9: inkxomo (act of hanging)

4. (a) Inkxomo yempahla yathatha ixesha elifutshane.

(The hanging of clothes took a short time).

(b) Inkxomo ingabangela ukubethana kwezimvo.

(The hanging may cause a clash of ideas).

xhoma (hang)

D. [Event]:

Class 11: uxhomo (hanging)

5. (a) Uxhomo lwempahla kufuneka lwenziwe ngendlela.

(The hanging of clothes ought to be done properly).

- (b) Uxhomo lwabantu lwenziwa esidlangalaleni kwamanye amazwe.
(The hanging of the people is done in public in other countries).

xhoma (hang)

E. [State]:

Class 14: ubuxhomi (quality of hanging)

6. (a) Ubuxhomi bufanele umntu owomeleleyo.
(The quality of hanging requires a strong person).
(b) Ubuxhomi bempahla bungcono xa ilanga lishushu.
(The hanging quality is better when the sun is hot).

tshiza (spray)

A. [Person]:

Class 1: umtshizi (a person who sprays)

1. Umtshizi wemoto wafaka umbala obomvu.
(The car sprayer sprayed a red colour).

tshiza (spray)

B. [Instrument]

Class 7: isitshizi (spraying instrument)

2. (a) Isitshizi sawukhupha kakuhle umbala ofunekayo.
(The spraying instrument discharged the appropriate colour perfectly).
(b) Isitshizi kwasetyenzwa ngaso imini yonke.
(The spraying instrument was utilised the whole day).

tshiza (spray)

C. [Action, Result]

Class 9: intshizo (act of spraying, pouring, splattering)

3. (a) Intshizo yemvula yaqininisa kakhulu.
(The drizzling of rain became heavier indeed).
(b) Intshizo yamanzi amdaka yachana abantwana.
(The splattering of dirty water hit the children)

tshiza (spray)

D. [Event]:

Class 11: utshizo (splatter, pouring water, drizzling)

4. (a) Utshizo lwemvula lwabangela abantu bawushiya umdlalo.
(The drizzling of rain made the people leave the game).
- (b) Utshizo lodaka lwachana imoto esecaleni kwendlela.
(The splattering of mud fell on the car next to the road).

tshiza (spray)

E. [Quality]:

Class 14: ubutshizo (quality of drizzling)

5. (a) Ubutshizo bemvula bushiye abantu bemanzi.
(The rain drizzle left people wet).
- (b) Ubutshizo bamkeleka kumafana.
(The quality drizzling was welcomed by the farmers).

galela (pour)

A. [Person]:

Class 1: umgaleli (a person who pours)

1. Umgaleli wagalela de yazala imbodlela.
(The pouring person poured into the bottle until it was full).

galela (pour)

B. [Event]:

Class 11: ugalelo (pouring, filling)

2. (a) Ugalelo lotywala lwathatha ixesha elifutshane.
(The pouring of alcohol took a short time).
- (b) Ugalelo lwamafutha lwayigcalisa imoto.
(The filling of petrol filled up the car).

faka (put inside)

A. [Person]:

Class 1: umfaki (a person who puts inside)

1. Umfaki-mavili wakhupha onke amavili amadala.
(The wheel installer took out all the old wheels).

faka (put inside)

B. [Event]:

Class 11: ufako (putting inside, spreading)

2. (a) Ufako lwemoto egaraji lwathatha ixesha elifutshane.
(The driving of the car inside the garage took a short time).
- (b) Ufako lwebhotolo esonkeni lwamvuyisa umntwana.
(The spreading of butter on the bread made the child happy).

thwala (carry on the head)

A. [Person]:

Class 1: umthwali (a person who carries on the head)

1. Umthwali nyanda wakhala ngentloko ebuhlungu.
(The wood carrier complained about a headache).

thwala (carry on the head)

B. [Action]:

Class 9: intwalo (act of carrying)

2. (a) Intwalo yenyanda yenziwa ngabantu ababhinqileyo.
(The carrying of the firewood is done by females).
- (b) Intwalo yomntuinzima kakhulu.
(The carrying of a person is very difficult).

thwala (carry on the head)

C. [Result]:

Class 3: umthwalo (load carried on head, vehicle, burden)

3. (a) Umthwalo wesithuthi wawungaphaya komlinganiselo.

(The load of the car was more than the requirement).

- (b) Umthwalo wokungezi kwabantwana esikolweni wabekwa phezu kwamagxa akhe.

(The burden of children bunking school was thrown at his shoulders).

thwala (carry on the head)

D. [Artifact]

Class 7: isithwalo (cloth carried on the head)

4. (a) Isithwalo sentombi saphetshethekiswa ngumoya.
(The girl's cloth was blown away by the wind).
(b) Isithwalo sagquma iinwele zomfazi.
(The head cloth covered the woman's hair).

thwala (carry on the head)

E. [Event]:

Class 11 uthwalo (carrying)

5. (a) Uthwalo losana emqolo luyathandwa ngomama.
(The carrying on the back of babies is liked by mothers).
(b) Uthwalo lwempahla lwamsinda umfazi.
(The carrying of clothes was heavy for the woman).

Class 11: uthwalo (abduction of a girl (cultural / tradition)

6. (a) Uthwalo lwentombi lwenzeka ebusuku.
(The abduction of the girl occurred in the evening).
(b) Uthwalo luphelisiwe ngumthetho omtsha.
(The abduction of woman has been abolished by the new legislation).

layisha (load)

A. [Person]:

Class 1: umlayishi (a person who loads)

1. Umlayishi walayisha intlabathi emotweni.
(The loading person loaded sand into the bakkie).

layisha (load)

B. [Event, Manner]:

Class 3: umlayisho (way of loading)

2. (a) Umlayisho weegusha wenziwa ngocoselelo.
(The loading of sheep was handled with care).
- (b) Umlayisho wempahla wasinda imoto.
(The loading of the clothes sagged the car).

layisha (load)

C. [Instrument]

Class 7: isilayisho (instrument for loading)

3. (a) Isilayisho salayisha impahla ibhokisi ngokukhawuleza
(The loading instrument loaded the boxes very quickly).
- (b) Isilayisho sasetyenziswa imini yonke ngabasebenzi.
(The loading instrument was used the whole day by the workers).

layisha (load)

D. [Event]:

Class 11: ulayisho (loading)

4. (a) Ulayisho lwempahla lwaqhubeka imini yonke.
(The loading of clothes took the whole day).
- (b) Ulayisho lomthwalo lwenziwa ngabasebenzi enqanaweni.
(The loading of the load is done by the workers in the ship).

In summary, it is clear from the above lexical schematic representation that the deverbal nominals derived from the put verbs can be found in almost all the noun classes with the exception of the noun class 3, 7, 9 and 14 for the verb **galela** and **faka** as they cannot be derived from these noun classes. The lexical semantic type for the deverbal nominals derived in noun class 1, 7 and 9 of the put verbs denotes person where the suffix is **-i**. The deverbatives in noun class 1, 7 and 9 with the suffix **-i** denoting person have the interpretation of an individual-level nominals (ILNs). In noun class 7 denoting person the interpretation may

be that of a stage-level nominals (SLNs) depending on how the deverbal noun is used. The semantic type for the deverbative nominals derived from noun class 14 denotes Quality for all derived nominals derived from this verb class.

4.3.10 Remove verbs with a locative argument

These verbs relate to verbs denoting the removal of an entity from a location. One of their arguments is expressed in a prepositional phrase headed by the preposition *from* in English, according to Levin (1993 : 123). The lexical schematic representation below demonstrates various deverbatives from the following noun classes 1, 3, 7, 9, 11 and 14 that are derived from various remove verbs with a locative argument.

	Class 1	class 3	class 7	class 9	class 11	class 14
xhwitha	umxhwithi	umxhwitho	isixhwithi	inkxwitho	uxhwitho	ubuxhwitho
gxotha	umgxothi		isigxothi	ingxothi	ugxotho	ubugxotho
susa	umsusi	umsuso	isisusi	intsuso	ususo	ubususo
khama	umkhami	umkhamo	isikhami	inkamo	ukhamo	
thatha	umthathi		isithathi	intatho	uthatho	
xhwila	umxhwili	umxhwilo	isixhwili	inkxwilo	uxhwilo	

In the lexical schematic representation below the various classes of the deverbal nominals derived from the remove verbs with a locative argument have been classified in terms of semantic type, such as Person, Event, Event, Manner of event, Action, Action, Result and Quality. The categorization of each deverbal nominal class is specified by means of a binary feature (+) for the various semantic types.

Class	thatha	gxotha	susa	khama	xhwitha	xhwila
Person						
1	+	+	+	+	+	+
7	+	+	+	+	+	+
9		+				
Event						
11	+	+	+	+	+	+
Event, Manner of event						
3			+	+	+	+
Action, Result						
9	+		+			
Action						
9				+	+	+
Quality						
14	+		+		+	

xhwitha (pluck)

A. [Person]:

Class 1: umxhwithi (a person who plucks)

1. Umxhwithi waxhwitha ii ntsiba zesikhwenene.
(The plucking person plucked the feathers of a parrot).

Class 7: isixhwithi (a person who plucks regularly / always)

2. (a) Isixhwithi sazilahla iintsiba zesikhwenene.
(The plucking person threw away the parrot's feathers).
- (b) Isixhwithi sendoda satyisa iinkuku.
(The plucking man fed the chickens).
- (c) Isixhwithi samadoda saqokelela zonke iinkuku).
(The group of plucking men gathered all the chickens)

xhwitha (pluck)

B. [Event, Manner]:

Class 3: umxhwitho (way of plucking, plucking)

3. (a) Umxhwitho wentsiba zenciniba unengeniso mali.
(The plucking of the ostrich feathers generates income).
- (b) Umxhwitho wenciniba wathatha ixesha elide).
(The plucking of the ostrich took a long time).

xhwitha (pluck)

C. [Event]:

Class 11: uxhwitho (plucking)

4. (a) Uxhwitho lwediliya lwenziwa ngabasenzi.
(The plucking of grapes was done by the workers).
- (b) Uxhwitho lweentsiba lushiya izandla zibuhlungu.
(The plucking of feathers leaves painful hands).

xhwitha (pluck)

D. [Action]

Class 9: inkxwitho (act of plucking)

5. (a) Inkxwitho yentsiba zenkuku yenziwa ngomatshini.

(The plucking of the chicken's feathers is done by a machine).

- (b) Inkxwitho boya bentaka benziwa yikati.

(The plucking of the bird's feathers was done by the cat).

xhwitha (pluck)

E. [Quality]:

Class 14: ubuxhwitho (quality of plucking, siphon)

6. (a) Ubuxhwitho bentsiba zenciniba bufanele inkcutshe.

(The quality plucking of ostrich feathers requires experts).

- (b) Ubuxhwitho bentsiba zenkuku bayenza yalungela ukuphekwa.

(The quality plucking of the chicken's feathers made it ready to be cooked).

The deverbatives derived from the remove verb with a locative argument **xhwitha** can be found in all the noun classes that are specified above. The lexical semantic type interpretations for the deverbal nominals derived from noun classes 1, 7 and 9 denotes person where the suffix is **-i**.

thatha (take away)

A. [Person]:

Class 1: umthathi (a person who takes, steal)

1. Umthathi-mali ubaleke amapolisa.

(The money taker ran away from the police).

Class 7: isithathi (a person who frequently takes)

2. (a) Isithathi-bantwana sibe umntwana.

(The frequent child stealer stole a child).

- (b) Isithathi sendoda sivalelwe esiseleni ngamapolisa.

(The frequent stealing man has been locked up in a cell by the police).

- (c) Isithathi samadoda sazithathela inyama.

(The group of frequent taking men took the meat by themselves).

thatha (take away)

B. [Event]:

Class 11: uthatho (taking away, removal)

3. (a) Uthatho lwebhotile yomntwana lumtsho wakhala.
(The taking of the child's bottle made her to cry).
- (b) Uthatho moto lwenzeka ebusuku.
(The removal of the car took place at night).

thatha (take away)

C. [Action]

Class 9: intatho (act of taking)

4. (a) Intatho mali yabangela umsindo kumzali.
(The taking of the money caused anger to the parent).
- (b) Intatho bantwana yamkhathaza umzali.
(The taking of the children worried the parent).

gxotha (expel)

A. [Person]:

Class 1: umgxothi (a person who expels)

1. Umgxothi-mntwana yaba yinqununu.
(The person expelling the child was the principal).

Class 7: isigxothi (a person who expels frequently /regularly)

2. (a) Isigxothi sakhuphela ngaphandle impahla zomhlali.
(The expelling person took the tenant's clothes outside).
- (b) Isigxothi sendoda samnika inyanga umhlali abe nokuhamba.
(The expelling man gave the tenant a month to leave).
- (c) Isigxothi samadoda sabiza intlanganiso kunye nabahlali.
(The expelling men called a meeting with the tenants).

Class 9: ingxothi (a person who expels)

3. (a) Ingxothi zange abanike thuba lakuthetha abahlali.
 (The expelling expert did not give the tenants a
 chance to explain themselves).
- (b) Ingxothi yafuna yonke imali yayo kubahlali.
 (The expelling expert wanted all his money from the
 tenants).

gxotha (expel)

B. [Event]:

Class 11: ugxotho (expulsion, dismissal)

4. (a) Ugxotho lwabangcuchalazi zange lwabonakalisa
 velwano.
 (The expulsion of the squatters never showed mercy).
- (b) Ugxotho lwabasebenzi lwabangela ugwayimbo.
 (The dismissal of the workers led to a strike).

gxotha (expel)

B. [Quality]:

Class 14: ubugxotho (expulsion, dismissal)

5. (a) Ubugxotho babasebenzi babangela indlala.
 (The quality dismissal of workers caused poverty).
- (b) Ubugxotho babantwan esikolweni banqunyanyiswa
 yinqununu.
 (The quality expulsion of children at school was
 suspended by the principal).

susa (remove)

A. [Person]:

Class 1: umsusi (a person who removes)

1. Umsusi moto yaba nguye onetyala.
 (The person removing the car is the one who was guilty).

Class 7: isisusi (a person who regularly removes)

2. (a) Isisusi kungcola sakhalimela abantu abangcolisayo.
(The regular dirt removing person admonished the people causing the dirt).
- (b) Isisusi sendoda sabiyela ibala ngocingo.
(The regular removal man encircled the field with a fence).
- (c) Isisusi samadoda saxelela abahlali ngendawo yokulahla inkukuma.
(The group of regular removal men showed the residents the place to dump their rubble).

susa (remove

B. [Action, Manner]

Class 3: umsuso (act of removal)

3. (a) Umsuso wabantu ematyotyombeni uhambe kakuhle.
(The removal of people from the shacks went well).
- (b) Umsuso wemiqobo wakhokelela ekubeni umfundi aqwalasele iincwadi zakhe.
(The removal of obstacles led to the student focusing on his books).

susa (remove

C. [Action, Result]

Class 9: intsuso (act of removing, removal)

4. (a) Intsuso yabantu kula ndawo idale umbhodamo.
(The removal of the people in that place caused chaos).
- (b) Intsuso yamatshontsho ekati yabangela ingxaki.
(The removal of the kittens caused a problem).

susa (remove)

D. [Event]:

Class 11: ususo (removing, removal)

5. (a) Ususo lwabantu lumele ukwenziwa sele kukho enye indawo.
(The removal of the people ought to be done when there is alternative place).
- (b) Ususo- nkxaso mali kwimbaleki ludale ukuthetha.
(The withdrawal of sponsorship to athletes has caused a lot of row).

susa (remove)

E. [Quality]:

Class 14: ubususo (quality of removal)

6. (a) Ubususo bezinto ezimdaka endleleni lwakhawuleza.
(The quality removal of rubble on the road was quick).
- (b) Ubususo bamaphepha benza isixeko sabukeka.
(The quality removal of papers made the village beautiful).

khama (wring)

A. [Person]:

Class 1: umkhami (a person who wrings)

1. Umkhami woneka impahla phandle.
(The wringing person hung the clothes outside).

Class 7: isikhami (a person who frequently wrings)

2. (a) Isikhami sahlamba impahla ngomashini.
(The frequent wringing person washed clothes with a machine).
- (b) Isikhami somfazi sakhama impahla emva kwendlu.
(The group of frequent wringing woman wrung the clothes in the backyard).

khama (wring)

B. [Event, Manner]:

Class 3: umkhamo, inkamo (wringing)

3. (a) Umkhamo wempahla wenziwa yintombi.
(The wringing of the clothes was done by the girl).
- (b) Umkhamo weengubo wathatha ixesha elide.
(The wringing of the blankets took a long time).

khama (wring)

C. [Action]:

Class 9: inkamo (act of wringing)

4. (a) Inkamo yempahla sisenzo esimele ukwenziwa ngobunono.
(The wringing of clothes ought to be done with care).
- (b) Inkamo yempahla iyadinisa emntwini.
(The wringing of clothes tires a person).

khama (wring)

D. [Event]:

Class 11: ukhamo (wringing)

5. (a) Ukhamo lwempahla lunceda impahla yome msinyane.
(The wringing of the clothes helps the clothes to dry up quickly).
- (b) Ukhamo lwempahla lwathatha imini yonke.
(The wringing of the clothes took a whole day).

xhwila (steal from someone, snatch)

A. [Person]:

Class 1: umxhwili (a person who snatches)

1. Umxhwili wabaleka nesipaji somfazi.
(The snatcher ran away with the woman's purse).

Class 7: isixhwili (a person who regularly snatches)

2. (a) Isixhwili saleqwa ngamapolisa.

(The regular snatcher was chased by the police).

- (b) Isixhwili sendoda sazimela amapolisa phantsi kwebhedi.

(The regular snatching man hid from the police under the bed).

- (c) Isixhwili samadoda saleqwa ngabahlali.

(The group of regular snatching men was chased by the community).

xhwila (steal from someone, snatch)

B. [Event, Manner]:

Class 3: umxhwilo (way of snatching)

3. (a) Umxhwilo wempahla zabantu awufuneki.

(The snatching of people's possessions is not right).

- (b) Umxhwilo nyama wenziwa yingonyama.

(The snatching of meat was done by the lion).

xhwila (steal from someone, snatch)

C. [Action]

Class 9: inkxwilo (act of stealing, snatching)

4. (a) Inkxwilo sisenzo esibi kakhulu.

(The snatching is an ugly act indeed).

- (b) Inkxwilo sipaji yabethisa umguvela ngabantu.

(The snatching of a purse led to a beating of the thug by the people).

xhwila (steal from someone, snatch)

D. [Event]:

Class 11: uxhwilo (snatching, stealing)

5. (a) Uxhwilo lwezinto zabantu lamkhokelela entolongweni.

(The snatching of people's things led him to jail).

- (b) Uxhwilo lokutya kwabantu lwabenza banomsindo.

(The snatching of the peoples' food made them angry).

In summary, it is evident from the above lexical semantic representation that only two deverbal nominals derived from the remove verbs with a locative argument can be found in almost all the noun classes, particularly those that are derived from the verb **xhwitha** and **susa** respectively. The lexical semantic type for the deverbal nominals derived from noun classes 1, 7 and 9 of remove verbs with a locative argument denotes person where the suffix is **-i**. These deverbatives have the interpretation of an individual-level nominals (ILNs). In noun class 7 denoting person the interpretation may be that of a stage-level nominals (SLNs) depending on how the deverbal noun is used. The semantic type for the deverbative nominals derived from noun class 14 denotes Quality for all derived nominals derived from this verb class.

4.4 DITRANSITIVE VERBS

4.4.1 Change of possession verbs

Levin (1993 : 138) states that change of possession verbs display the dative alternation and that the prepositional phrase is optional with some of these verbs, when it does appear, it must be headed by the preposition *to* in English.. The lexical schematic representation below demonstrates various deverbatives from the following noun classes 1, 3, 7, 9, 11 and 14 that are derived from various change of possession verbs.

	Class 1	class 3	class 7	class 9	class 11	class 14
nika	umniki					
boleka	umboleki	umboleko	isiboleki	imboleki/o	uboleko	ububoleko
ondla	umondli		isondlo			
pha	umpho	umpho	isipho		uphiwo	
thuma	umthumi	umthumo	isithumi	intumo	uthumo	ubuthumo

In the lexical schematic representation below the various classes of the deverbal nominals derived from the change of possession verbs have been classified in terms of semantic type, such as Person, Event, Event, Manner of event, Action, Result and Quality. The categorization of each deverbal nominal class is specified by means of a binary feature (+) for the various semantic types.

Class	nika	boleka	ondla	pha	thuma
Person					
1	+	+	+	+	+
7		+			+
9		+			
Event					
11		+		+	+
Event, Manner of Event					
3		+		+	+
Action					
7		+			
9		+			+
Result					
7				+	
Quality					
14		+			+

nika (give)

A. [Person]:

Class 1: umniki (a person who gives)

1. Umniki waphathela abantwana iingubo.
(The giver gave the children blankets).

boleka (borrow)

A. [Person]:

Class 1: umboleki (a person who borrows)

1. (a) Umboleki akazibuyisi izinto zabantu.
(The borrower does not return other people's things).
- (b) Umboleki wasebenza iminyaka emithathu evenkileni.
(The borrower worked for three years in the shop).

Class 7: isiboleki (a person who regularly borrows)

2. (a) Isiboleki semka nemhlakulo yam.
(The regular borrower left with my spade).
- (b) Isiboleki sendoda saboleka umhlakulo kuThemba.
(The regular borrowing man borrowed a spade from Themba).
- (c) Isiboleki samadoda zange sihlawule ibhanki.

(The group of regular borrowing men did not pay the bank).

Class 9: imboleki (expert borrower)

3. (a) Imboleki yathenga impahla eninzi kwa-Edgars.
(The expert borrower bought a lot of clothes from Edgars).
- (b) Imboleki yendoda zange ikwazi ukuyibuyisa imali yebhanki.
(The expert borrowing man was unable to repay the bank's money).

boleka (borrow)

B. [Event, Manner]

Class 3: umboleko (way of borrowing, lending)

4. (a) Umboleko wemali owenziwa ngoMatshonisa awulunganga.
(The lending of money done by the Matshonisa's is not right).
- (b) Umboleko wabamelwane wamenza walahlekelwa zizitya zakhe.
(The borrowing by the neighbours of he dishes made her to lose them).

boleka (borrow)

C. [Action]:

Class 9: imboleko (act of borrowing)

5. (a) Imboleko yadala ubutshaba phakathi kwabo.
(The borrowing created enmity between them).
- (b) Imboleko kutya yamsindisa endlaleni.
(The borrowing salvaged him from poverty).

boleka (borrow)

D. [Event]:

Class 11: uboleko (borrowing, lending)

6. (a) Uboleko lwemali lumele ukwenziwa ngendlela.
(The lending of money ought to be done properly).
- (b) Uboleko lweencwadi zange luvumeleke phakathi kwabafundi.
(The borrowing of books was not allowed amongst the students).

boleka (borrow)

E. [Quality]:

Class 14: ububoleko (quality of borrowing)

7. (a) Ububoleko bekhuba balenza laphela kubamelwane.
(The borrowing quality led to the hoe ending up with the neighbours).
- (b) Ububoleko bemali bulawulwa yimithetho yeebhanki.
(The borrowing quality is being regulated by bank legislation).

The deverbatives derived from the change of possession verb **boleka** can be found in all the noun classes that are shown above. The lexical semantic type interpretations for the deverbal nominals derived from noun classes 1, 7 and 9 denote person where the suffix is **-i**.

ondla (feed)

A. [Person]:

Class 1: umondli (a person who feeds)

1. Umondli watyisa usana ekuseni.
(The feeding person fed the child in the morning).

ondla (feed)

B. [Action]

Class 7: isondlo (act of feeding, maintenance)

2. (a) Isondlo sahlawulwa kwamantyi ngumzali.
(The maintenance was paid in court by the parent).
- (b) Isondlo wasikhupha rhoqo ngenyanga.
(The maintenance was paid every month).

pha (give)

A. [Person]:

Class 1: umphi (a person who gives)

1. Umphi wathyumela bonke abantwana kumzi wezilwanyana.
(The giver sent all the children to the Zoo).

pha (give)

B. [Event, Manner]:

Class 3: umpho (way of giving, offering)

2. (a) Umpho wesipho wenzeka eholweni.
(The giving of the gift happened in the hall).
- (b) Umpho wempahla wahanjelwa zindwendwe ezibekekileyo.
(The giving of clothing was graced by respected visitors).

pha (give)

C. [Result]:

Class 7: isipho (gift)

3. (a) Isipho wasithumela ngeposi phambi kweKrisimesi.
(The gift was sent by post before Christmas).
- (b) Isipho asifumanayo kumalume wakhe sasithandeka.
(The gift he received from his uncle was likeable).

pha (give)

D. [Event]:

Class 11: uphiwo (way of giving)

4. (a) Uphiwo lwabantwana ukutya lwabavuyisa.
(The giving of children food made them happy).
- (b) Uphiwo lwabantu izindlu luhamba kade.
(The giving of people houses takes a long time).

thuma (send)

A. [Person]:

Class 1: umthumi (a person who sends)

1. Umthumi wathuma abantwana icuba evenkileni.
(The sender sent children to the shop for tobacco).

Class 7: isithumi (a person who regularly sends)

2. (a) Isithumi sathuma intombi isonka.
(The regular sender sent the girl for bread).
- (b) Isithumi sendoda sathuma abantwana ubisi evenkileni.
(The regular sending man sent children to the shop for milk).
- (c) Isithumi samadoda sathumela iileta emakhaya.
(The group of regular sending men sent letters for home).

thuma (send)

B. [Event]

Class 3: umthumo (sending)

3. (a) Umthumo wabantwana evenkileni uyingozi kwezi mini.
(The sending of children to the shop is dangerous these days).
- (b) Umthumo evenkileni wakhokelela kulahleko lomntwana.
(The sending of the child to the shop led to his disappearance).

thuma (send)

C. [Action]:

Class 9: intumo (act of sending)

4. (a) Intumo edolophini yenziwa ngumntu omdala.
(The sending to town was done by an old person).
- (b) Intumo ebusuku yamfaka ezingozini Usivuyile.
(The sending at night led Sivuyile to trouble).

thuma (send)

D. [Event]:

Class 11: uthumo (sending)

5. (a) Uthumo lwenkwenkwe evenkileni lwenzeka kusasa.
(The sending of the boy to the shop happened in the morning).
- (b) Uthumo lomntwana inyama lwenziwa ngumzali.
(The sending of the child was done by the parent).

thuma (send)

E. [Quality]:

Class 14: ubuthumo (quality of the directive, sending)

6. (a) Ubuthumo bendoda edolophini benziwa ngokukhawuleza.
(The sending of the man to town was done with haste).
- (b) Ubuthumo bomfana ebukhweni bagxekwa ngamaxhego.
(The sending of the young man to the in laws was criticised by the old men).

In summary, it is evident from the above lexical semantic representation that only two deverbal nominals derived from the change of possession verbs can be found in almost all the noun classes, particularly those that are derived from the verbs **boleka** and **thuma** respectively. The lexical semantic type for the deverbal nominals derived from noun classes 1, 7 and 9 of these verbs denote person where the suffix is **-i**. These deverbatives with the suffix **-i** denoting person have the interpretation of an individual-level nominals (ILNs). In noun class 7 denoting person the interpretation may be that of a stage-level nominals (SLNs)

depending on how the deverbal noun is used. The semantic type for the deverbative nominals derived from noun class 14 denotes Quality for this verb class.

4.5 CONCLUSION

This chapter has explored the systematic representation of deverbal nominals in Xhosa derived from intransitive, transitive and ditransitive verb classes. A lexical schematic representation for each verb class has demonstrated the derivation or lack thereof of the deverbal nominal for the different noun classes specified. In state verbs the noun classes that illustrate an adequate representation of the derived deverbal nominals are noun classes 1 and 7/8 respectively.

It seems that state verbs mostly derive deverbal nominals that display the semantic type person. The least noun class that is derived across the intransitive and transitive verb classes is noun class 5. The deverbal nominals derived from noun class 5 denotes person with a derogatory interpretation. It is evident that the deverbatives in noun class 1, 7/8 and 9 with the suffix *-i* denoting person have the interpretation of an individual-level nominals (ILNs). In noun class 7 denoting person the interpretation may be that of a stage-level nominals (SLNs) depending on how the deverbal noun is used. The deverbatives in noun class 5 denoting person have an interpretation of a stage-level nominals (SLNs).

It has also been shown in this chapter that there is a sizeable data of deverbal nominals derived from noun class 11 and 14 across all verb classes. The general semantic interpretation for these noun classes are [event, manner] and [quality] respectively. The verbal class which displayed the least deverbal nominal derivation is the motion verb class where the locative refers to direction. Weather verbs showed that their deverbal nominals can mostly be derived in noun class 11 with an [event, manner] interpretation. Deverbal nominals derived from verbs relating to the body (bodily processes) are the most evenly represented across all noun classes except for noun class 5 which is the noun class represented.

CHAPTER 5

A GENERATIVE LEXICON THEORETICAL ANALYSIS OF DEVERBAL NOMINALS

5.1 INTRODUCTION

This chapter 5 provides a detailed analysis of various deverbal nouns derived from different verb classes. This chapter is situated against the theoretical paradigm of the Generative Lexicon Theory. The present analysis on deverbal nouns is vested on the foundations laid in recent years by Pustejovsky (1995, 1996) and Busa (1996), as discussed in chapter 2. The first part of this chapter focuses on the analysis of deverbal nominals derived from intransitive verbs classes followed by an analysis on the deverbal nominals derived from transitive verb classes.

The analysis presented here in chapter 5 follows from Pustejovsky's (1996) GLT, particularly, his analysis of the semantics of nominals. This chapter also investigates the distinction in complement taking behaviour of various deverbal nouns derived from various verb classes. The first part looks at the lexical semantic representation of a particular verb class wherein the argument structure, event structure and qualia structure of the selected verb are analyzed. The second part focuses on the deverbal nouns as derived from the selected verb class in a specific noun class. The method employed here is to investigate the similarities and differences as regards to the lexical semantic representations of the various deverbal nouns with regard to their different noun classes.

In these deverbal nouns the focus is on the lexical semantic representation wherein the argument structure is explored so as to determine how these arguments are realized syntactically, the event structure is examined to establish what these deverbal nouns denote, and the qualia structure is explored so as to ascertain the set of properties or events linked with these deverbal nouns. The derived deverbal nominals will be illustrated in phrase markers in the form of a noun phrase (NP) dominated by a determiner phrase (DP) projection. Visser (2008: 16) specifies that the vowels **i-** and **u-** may occur as the preprefix of the nouns in isiXhosa and can be viewed as allomorphic realizations of the determiner category.

The organisation of this chapter is as follows: Section 5.1 is the general introduction detailing the general contents of this chapter. Section 5.2 contains the analysis of one deverbative for each intransitive verb classes. In section 5.3 the various sub-areas of the deverbatives under transitive verb classes are analysed. Section 5.4 presents an analysis of a deverbative that has been derived from change of possession verb class. Section 5.5 concludes the chapter.

One of the most prolific areas of research in Generative syntax since the mid 1980's has been in the area of functional categories. Functional categories, in contrast with lexical categories like nouns, verbs, adjectives etc. lack referential or descriptive content (cf. Cinque 1994, Cook and Newson 1996:186, Van Gelderen 1993). Functional categories are specified for grammatical features. The clausal category I(inflection) has been postulated by Pollock (1989) to be decomposed into a number of functional category heads, Agr(eement), subject, Neg(ative), T(ense), each projecting a phrase, i.e. AgrS Phrase, Neg Phrase, and Tense Phrase respectively, which has an internal structure conforming to X-bar structure, containing a specific and complement. For example, AgrS is complement of the Specifier AgrS¹ and takes the complement Neg Phrase. Through a movement process of head-to-head movement the verb attaches to each functional head successively to derive a complex (zero-level) lexical category.

Luigi Rizzi (1997, 2001b, 2003) postulated a similar split (or decomposed) structure for the complementizer Phrase (cf Radford 2004) consisting of Force Phrase, Focus Phrase and Topic Phrase.

The rationale for introducing functional categories in a split (or decomposed) Inflection Phrase and Complementiser Phrase has been invoked by Abney (1987) for positing functional category projections for the Noun Phrase. Specifically, Abney has argued that NP is dominated by a D(eterminer) Phrase headed by the functional category D(eterminer). Determiners can be articles (**the, a** in English), demonstratives and quantifiers (cf. Guisti 1997).

Abney (1987:64f) characterizes functional categories in terms of the following properties:

- a. They constitute closed lexical classes.
- b. They are generally phonologically and morphologically dependent. They are generally stressless, often clitics or affixes, and sometimes even phonologically null.
- c. They permit only one complement, which is in general not an argument.

- d. They are usually inseparable from their complement.
- e. They lack 'descriptive content'. Their semantic contribution, regulating or contributing to the interpretation of their complement. They mark grammatical or relational features, rather than picking out a class of objects.

For some languages, the head of a noun phrase merges with the D(eterminer) head of the DP by which it is dominated to form a complex zero-level category (cf. Haegeman 1997).

Visser (2008) argues that this kind of movement of N-to-D is argued to take place in the Xhosa D(eterminer) Phrase, where the initial vowel of the noun, i.e. the preprefix (or augment) is posited to be a functional category Determiner. In the DP structures presented below for the various deverbatives it is assumed, following Visser (2008) that N-to-D (i.e. head-to-head) movement takes place to derive a complex zero-level category D(eterminer).

5.2 INTRANSITIVE VERBS

5.2.1 State verbs

In section 4.2 sub-section 4.2.1 the state verbs were analysed in terms of their deverbatives, and Levin (1993) described these verb classes in sub-section 4.2.1. In the following section 5.2 sub-section 5.2.1 the deverbatives from the verb **lamba** are examined in terms of their use. The various deverbatives derived from the intransitive state verb **lamba** demonstrate a semantic type such as Person, Inchoative state, State, Feelings, Result and Quality as is illustrated below.

Nominalisation from the verb **-lamba** (hungry)

-lamba (hungry)

1. Umntwana ulambile.
(The child is hungry).

-lamba	
ARGSTR	= ARG 1 = x : phys. obj
EVSTR	= E 1 = e ₁ : state
QUALIA	= FORMAL = X
	AGENTIVE -lamba (e ₁ , x, y)

Hierarchy of semantic concepts

Verb - **lamba** : Hungry - State

The lexical semantic representation of the state verb **-lamba** can be explained as having one argument in its argument structure (ARGSTR), which is a physical object, specifically a human. The event structure (EVSTR) of the verb **-lamba** specifies the state of being hungry. The qualia features include the formal quale which specifies the identity of the physical object (X), and the agent quale specifies the state of being hungry of the person (X).

Class 1

Prefix: **um-**

Suffix: **-i**

umlambi (a hungry person)

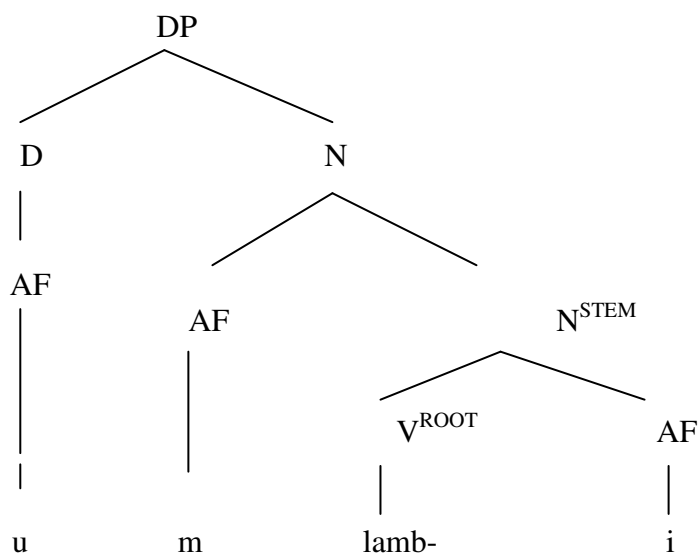

Nominalisation in class 1

umlambi (habitually / chronically hungry person)

2. Umlambi uyakhalaza.
(The hungry person is complaining).

umlambi	
ARGSTR	= ARG 1 = x : human
EVSTR	= E 1 = e ₁ : state
QUALIA	= FORMAL = (e _r , x)
	AGENTIVE = -lamba _state (e ₁ , x)

Hierarchy of semantic concepts

Be hungry : State - Human

The lexical semantic representation of the deverbative noun **umlambi** demonstrates in its argument structure (ARGSTR), only one argument. The event structure exhibits a default event representing the state of being hungry. The qualia structure specifies the formal quale expressing the identity of the human argument (X) and the agentive quale displays the state (e₁) of being hungry of a person.

Class 3

Prefix: **um -**

Suffix: **- o**

umlambo ((way of) becoming hungry)

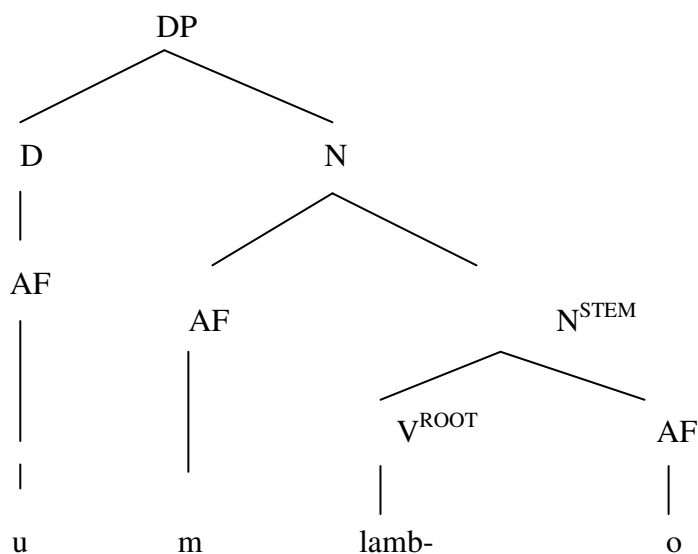

Nominalisation in class 3

umlambo (becoming hungry – inchoative state)

3. Umlambo wakhalisa umntwana.
(The becoming hungry made the child cry).

umlambo	
ARGSTR	= ARG 1 = e : r D – ARG 1 = x : phys. obj
EVSTR	= D - E 1 = e ₁ : state : inchoative
QUALIA	= FORMAL = (e _r , x, y) AGENTIVE = -lamba_ (e ₁ , x)

Hierarchy of semantic concepts

Hunger : State - Inchoative

The lexical semantic representation of **umlambo** in (2) above demonstrates that there are two arguments in its argument structure (ARGSTR), one of which is a default argument (i.e, the physical object). The first argument ARG 1, displays the reference (r) of the event (e) of getting hungry by itself. The event structure (EVSTR) demonstrates the default argument which is an inchoative state of a physical object becoming hungry. The qualia structure specifies the formal quale expressing the identity of the human argument (X) and the agentive quale displays the inchoative state (e₁) of being hungry of a person. The noun **umlambo** in (2) above, refers to an individual-level nominal which is defined with respect to a particular event.

Nominalisation in class 3

umlambo (way of becoming hungry)

4. Umlambo uyabothusa abantu.
(The way of becoming hungry scares the people).

umlambo	
ARGSTR	= ARG 1 = e : r D - ARG 1 = x : phys. obj
EVSTR	= D - E 1 = e ₁ : state : inchoative
QUALIA	= FORMAL = (e _r , x, y) AGENTIVE = -lamba _manner (e ₁ , x)

Hierarchy of semantic concepts

Hunger : Manner - Human

The lexical semantic representation of **umlambo** in (4) above can be explained in a similar way to (3) above, with the only difference specified in the formal quale in which the feature [Manner] is present. The deverbative noun **umlambo** in (4) above refers to a stage level nominal which is defined in relation to a particular event.

Class 5

Prefix: **i (li)**

Suffix: **- a**

ilamba (hungry man)

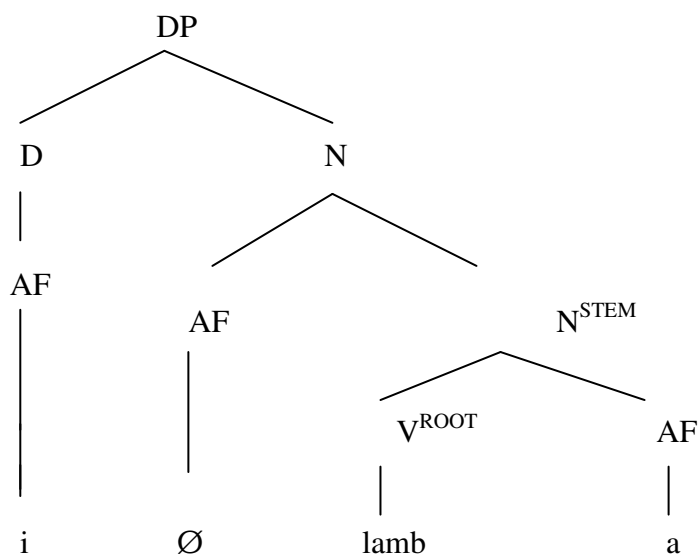

Nominalisation in class 5**ilamba** (chronically hungry person)

5. Ilamba lilele.
(The chronically hungry person is asleep).

ilamba	
ARGSTR	= ARG 1 = x : human
EVSTR	= D - E 1 = e ₁ : state
QUALIA	= FORMAL = x [derogatory]
	AGENTIVE = -lamba _state (e ₁ , x)

Hierarchy of semantic concepts

Hungry - State - Human

The lexical semantic representation of the deverbative noun **ilamba** displays in its argument structure (ARGSTR) that only a human being is capable of being hungry. The event structure (EVSTR) exhibits a default event which represents the state of being hungry. The qualia structure specifies the formal quale expressing the identity of the human argument (X) and the agentive quale displays the state (e₁) of being hungry of a person. The formal quale has a feature [derogatory], which is absent in (1) above.

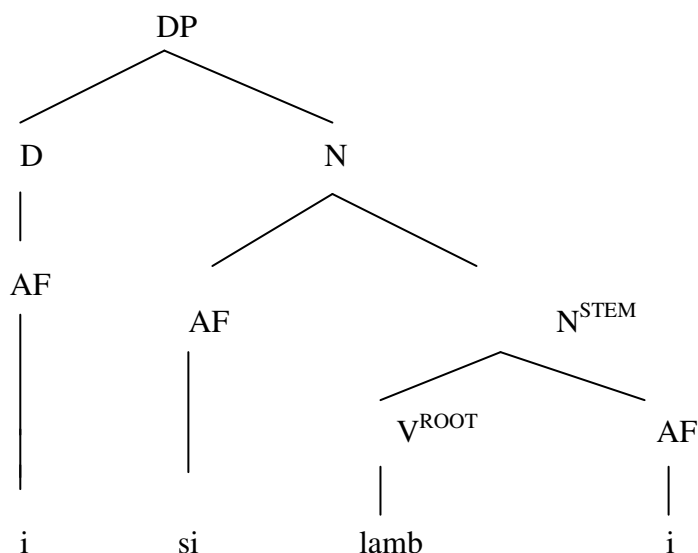
Class 7Prefix: **isi**Suffix: **-i****isilambi** (hungry man)**Nominalisation in class 7****isilambi** (severely hungry person)

6. Isilambi sendoda siyaphumla.
(The severely hungry person is resting).

isilambi	
ARGSTR	= ARG 1 = x : human
EVSTR	= D - E 1 = e ₁ : state
QUALIA	= FORMAL = (e _r , x)
	AGENTIVE = -lamba _intensive (e ₁ , x)

The lexical semantic representation of **isilambi** in (6) above can be explained similarly to (1) and (2) above. The only difference is specified in the formal quale, which bears the feature [intensive], not present in (1) and (2). The singular form of the deverbative noun **isilambi** in class 7 can appear with a genitive NP which is a cognate noun in the form of a descriptive possessive as is illustrated in (6).

Class 11Prefix: **u(lu)**

Suffix: -o

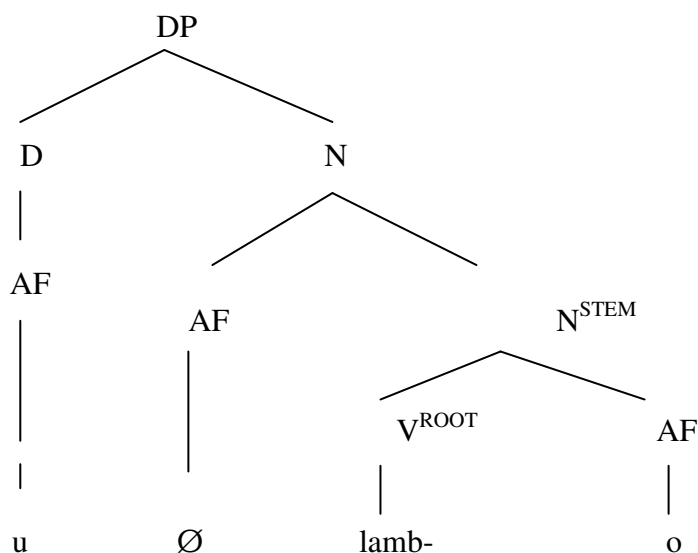
ulambo (hunger)**Nominalisation in class 11****ulambo** (hunger)

7. Ulambo lubakhokelele ebuseleni.
(The hunger led them to criminality)

ulambo	
ARGSTR	= ARG 1 = e : r D – ARG 1 = x : phys. obj
EVSTR	= D - E 1 = e ₁ : state
QUALIA	= FORMAL = -lamba _ state (e ₁ , x) AGENTIVE = -lamba _ Result (e _r , x)

Hierarchy of semantic concepts

Hunger - State - Result

The lexical semantic representation of **ulambo** in (7) above can be explained similarly to (4) above, with the difference that in the event structure of (7) the event structure is not inchoative as in (4). The absence of this feature of inchoative therefore indicates that **ulambo** is a full state, not a becoming state, in which the semantic feature of [Result] is prominent.

Class 14

Prefix: **ubu**

Suffix: **-o**

ubulambo (quality of hunger)

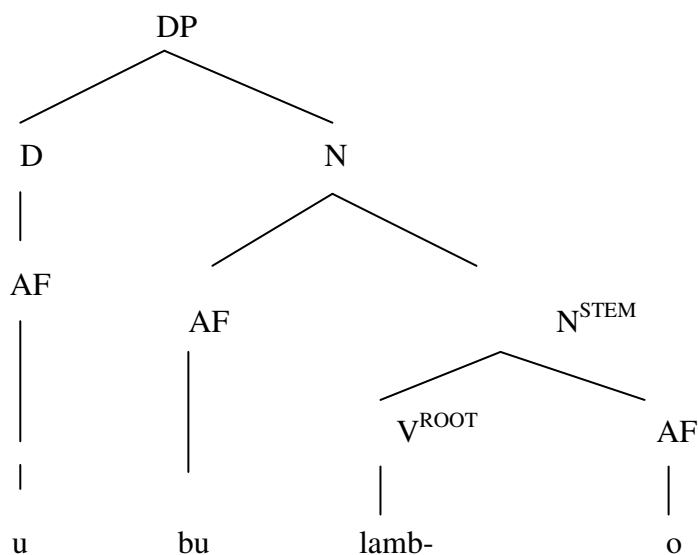

Nominalisation in class 14

ubulambo (quality of hunger)

8. Ubulambo babulala imfuyo.
(The quality hunger killed livestock).

ubulambo	
ARGSTR	= ARG 1 = e : r
	D – ARG 1 = x : phys. obj
EVSTR	= D - E 1 = e ₁ : state
QUALIA	= FORMAL = -lamba _ state (e ₁ , x)
	AGENTIVE -lamba _ quality_ animate (e ₁ , x)

Hierarchy of semantic concepts

Hunger - State - Quality

The lexical semantic representation of **ubulambo** (quality of hunger) in (8) can be explained similarly to (7) above, with the only difference specified in the formal quale in which the feature [quality] is added. This feature specifies the quality of a hungry state of the animate noun.

Observation regarding the analysis of state verbs:

The above analysis of deverbatives derived from the state verb **-lamba** can be illustrated as shown below:

- A. All intransitive state verbs take an animate argument, and one formal quale in term of which the animate argument is in a state of (hunger) (e₁, x).
- B. **Nominalisation in class 1**

The analysis reflects the verb **-lamba** in (1), except that the argument is human, hence the semantic concept refers to the feature [Human]. The presence of the prefix **-um** and the suffix **-i** compositionally realize an interpretation of human for **umlambi**.

Nominalisation in class 5

The class 5 deverbative **ilamba** in (5) above can be analysed in a similar way to class 1, the only difference relates to the agentive quale which displays the feature [state]

introduced by the prefix **-i** in class 5. In addition the formal quale display the feature [derogatory].

C. **Nominalisation in class 7**

The class 7 deverbative with the suffix **-i** denotes the feature human. The analysis of class 7 deverbative is similar to that of class 1 nominalisation, the only difference relates to the agentive quale which displays the feature [intensive] introduced by the prefix **isi-** in class 7. The deverbative nominal **isilambi** can appear as a head in an NP taking a descriptive possessive realized as a cognate noun.

D. **Nominalisation in class 3**

The argument **umlambo** in class 3 in (4) above, refers to the process of getting hungry. The argument is shown in the formal quale (x) to refer to the act of being hungry. In addition the feature [Manner] appears in the agentive.

E. **Nominalisation in class 11**

The argument **ulambo** in class 11 can be analysed in a similar way to (4) above. The only difference relates to the agentive quale which demonstrates the feature [Manner] introduced by the prefix **-u(lu)**. In class 11 the deverbative noun **ulambo** refers to an individual level nominal which is defined to a particular event.

F. **Nominalisation in class 14**

The argument **ubulambo** in class 14 can be analysed in a similar way to class 11 in (7) above. The only difference relates to the agentive quale which exhibits the feature [Quality] introduced by the prefix **ubu**. In class 14 the deverbative noun **ubulambo** refers to the stage level nominal.

In summary, the examples of deverbatives derived from intransitive state verbs demonstrate that these deverbatives are most prevalent in class 7. These deverbatives denote count nouns where the nominal suffix is **-i**. There is a small number of deverbatives in class 5, in section 4.2 sub-section 4.2.1, which also denote count nouns and have a nominal suffix **-a** or **o**. In this group of deverbatives the verb **lunga** has only one deverbative **ilunga** in class 5, it does not have any other corresponding deverbal nominal in other noun classes.

A small number of deverbatives appear in class 9, and these nominals mostly denote count nouns where the nominal suffix is **-i**, in section 4.2 subsection 4.2.1. There are two deverbatives in class 9 where the nominal suffix is **-o**, **inkuthalo** and **impakamo** which denote state and feelings, respectively. The deverbatives denoting humans have corresponding plurals, however, the nouns in class 9 denoting state and feeling are not readily associated with corresponding plural forms, as can be illustrated with the uncharacteristic deverbatives ***iinkuthalo** and ***iimpakamo**, respectively. It is evident that the set of lexical semantic representations of the range of nominals derived from the intransitive state verbs in subsection 4.2.1 of chapter 4 can be analysed in terms of a similar lexical semantic representations presented in sub-section 5.2.1 of chapter 5 as is demonstrated in the analysis of the state verb **lamba** in sub-section 5.2.1 above.

5.2.2 Motion verbs

In sub-section 4.2.2 of chapter 4 the motion verbs were analysed in terms of their deverbatives, and Levin (1993) described these verb classes in sub-section 4.2.2. The motion verbs as explained in sub-section 5.2.2 of chapter 5 display the lexical schematic representation below which demonstrates various deverbatives from the following noun classes 1, 3, 5, 7, 8, 9 and 11. In the following section 5.2 sub-section 5.2.2 the deverbatives from the verb **hamba** are examined in terms of their use. The various deverbatives derived from the intransitive motion verb **hamba** demonstrate a semantic type such as Person, Event, Action/Result and Cognition as specified in sub-section 5.2.2 of chapter 5.

Nominalisation with the verb **-hamba** (go)

-hamba (go)

1. Abantwana bahamba endleleni.
(The children walk on the road).

-hamba	
ARGSTR	= ARG 1 = x : phys(ical) object D – ARG 1 = y : location
EVSTR	= E 1 = e_1 : process
QUALIA	= FORMAL = X AGENTIVE = -hamba _ act (e_1 , x , y)

Hierarchy of semantic concepts

Walk - motion

The lexical semantic representation of the motion verb **-hamba** can be explained as displaying two arguments in its argument structure (ARGSTR), one argument is the physical object denoting the entity performing the process, and the other argument is the default argument (i.e. the location where (to) the walking is taking place). The event structure (EVSTR) shows that the verb expresses a process. The qualia properties display the formal quale, which denotes the identity of the physical object (X) and the agentive quale which denotes the act (process) of walking (e_1) of a physical object (X) in a certain location (y).

Class 1

Prefix: **um-**

Suffix: **-i**

umhambi (traveller)

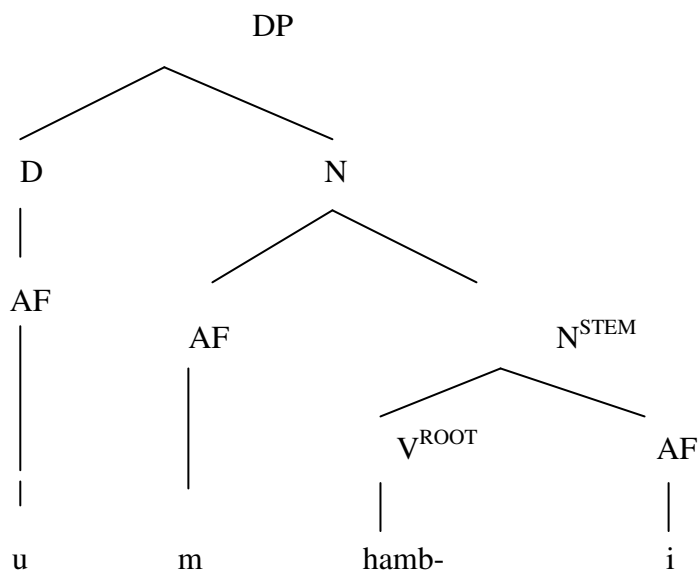

Nominalisation in class 1

umhambi (habitually travelling person)

2. Umhambi unxaniwe.
(The traveller is thirsty).

umhambi	
ARGSTR	= ARG 1 = x : phys(ical) object D – ARG 1 = y : location
EVSTR	= E 1 = e ₁ : process
QUALIA	= FORMAL = X
	AGENTIVE = -hamba _ act (e ₁ , x, y)

Hierarchy of semantic concepts

Traveller - habitual - motion - Actor - Human

The lexical semantic representation of the deverbative noun **umhambi** (traveller) in (2) demonstrates that in its argument structure (ARGSTR) it has two arguments; the one argument is human who travels, and the other argument is a default argument, (i.e. the location where the walking is taking place). The event structure (EVSTR) represents the default process event of walking. The qualia features display the formal quale denoting the identity of the human argument (X), and the agentive quale, which denotes the act (process) of walking / travelling (e₁) of a person (X).

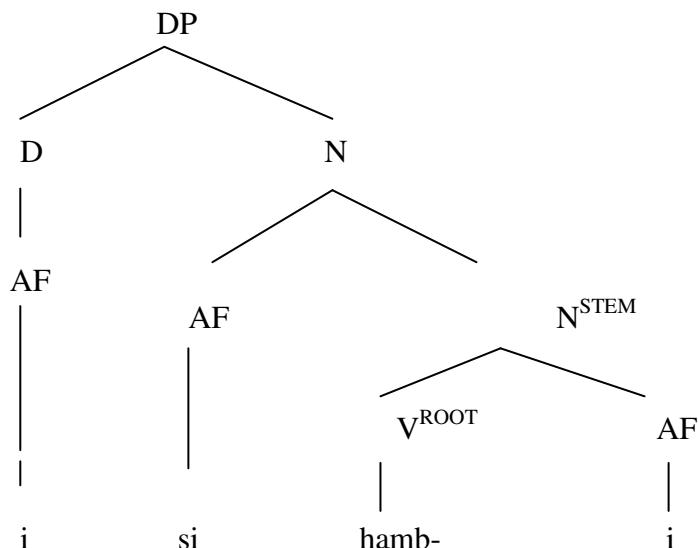
Class 7Prefix: **isi-**Suffix: **-i****isihambi** (traveller)**Nominalisation in class 7****isihambi** (a habitually travelling / walking person)

3. Isihambi sindulukile.
(The habitual traveller has left).

isihambi	
ARGSTR	= ARG 1 = human D – ARG 1 = y : location
EVSTR	= D - E 1 = e ₁ : process
QUALIA	= FORMAL = X AGENTIVE = hamba_ act_intensive (e ₁ , x, y)

Hierarchy of semantic concepts

Walk - Intensive - Motion Actor – Human

The lexical semantic representation of the deverbative noun **isihambi** in (3) above, can be explained in a similar way to the representation of **umhambi** in (2) above. The only difference relates to the agentive quale which in addition has the feature [Intensive] to the act of walking, hence some person is intensively / habitually walking / travelling to a certain

location. The deverbative noun **isihambi** can appear as a head in a NP taking a descriptive possessive realized as a cognate noun.

Class 5

Prefix: **i (li)-**

Suffix: **-i**

ihambi (traveller)

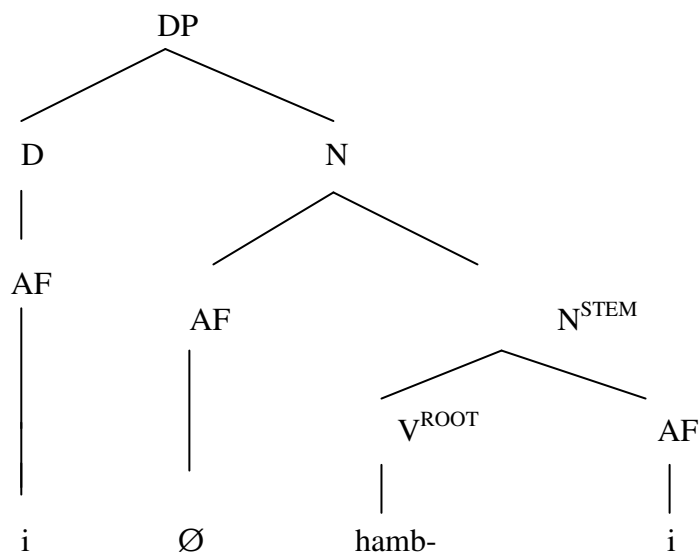

Nominalisation in class 5 with suffix – i

ihambi (a person who walks / travels (derogatory))

4. Ihambi alithethi.

(The habitual traveller does not talk).

ihambi	
ARGSTR	= ARG 1 = x : human
	D – ARG 1 = y : location
EVSTR	= D - E 1 = e ₁ : process
QUALIA	= FORMAL = X (derogatory)
	AGENTIVE = hamba _ act (e ₁ , x, y)

Hierarchy of semantic concepts

Traveller - Process - Actor-Human

The lexical semantic representation of the deverbative noun **ihambi** (traveller) can be explained similarly to the explanation for **isihambi** in (4) above. The only difference is that the feature intensive is absent here and the formal quale bears the feature [derogatory]. Thus a

traveller with [derogatory] denotation is travelling to a certain location. The deverbative noun **ihambi** can appear as a head in an NP taking a descriptive possessive realized as a cognate noun.

Class 5

Prefix: **i (li)-**

Suffix: **-o**

ihambo (walking / travelling)

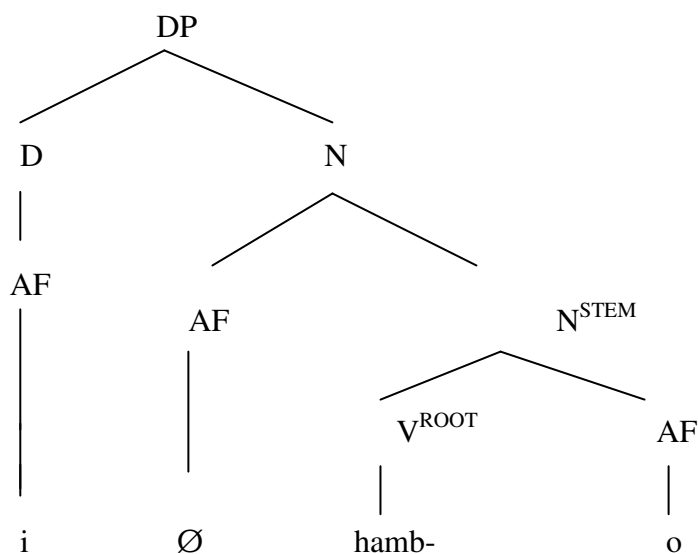

Nominalisation in class 5 with suffix –o

ihambo (journey / walk, act of travelling / walking) [derogatory]

5. Ihambo iyathandwa ngabantu.

(The act of travelling / walking is liked by the people).

ihambo

ARGSTR = ARG 1 = $x : e : r$

D – ARG 1 = x : phys(ical) object)

D – ARG 2 = y : location

EVSTR = D - E 1 = e_1 : process

QUALIA = FORMAL = (e_r, x, y)

AGENTIVE = **hamba**_act (e_1, x)

Hierarchy of semantic concepts

Walk - Motion - Act - Event

The lexical semantic representation of **ihambo** in (5) above displays three arguments in its argument structure, of which two arguments are default arguments, namely the physical object that exhibits movement, and the location at / in which this entity is walking. The other argument is the reference of the act of walking / travelling by itself. The noun **ihambo** in (5) above, refers to a stage level nominal which is defined with respect to a particular event.

Class 3

Prefix: **um-**

Suffix: **-o**

umhambo (manner of travelling)

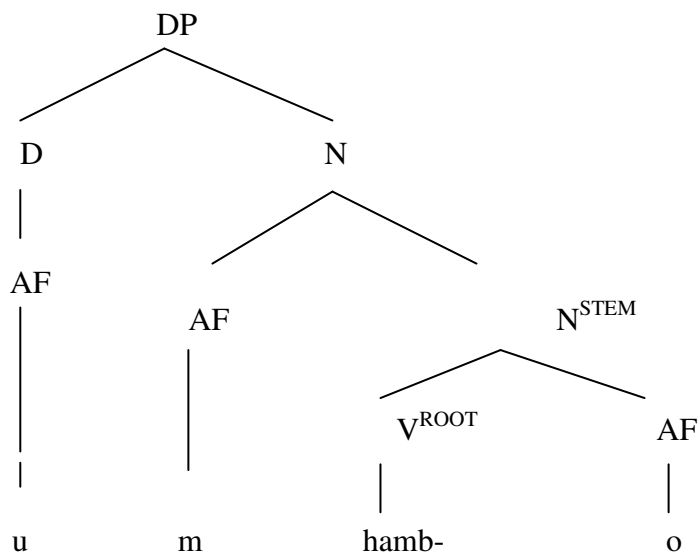

Nominalisation in class 3 [Manner]

umhambo (manner of travelling)

6. Ndiwubonile umhambo wabo.
(I saw their manner of walking / travelling).

umhambo

ARGSTR = ARG 1 = $x : e : r$

D – ARG 1 = x : phys(ical) object)

D – ARG 2 = y : location

EVSTR = D - E 1 = e_1 : process

QUALIA = FORMAL = (e_r, x, y)

AGENTIVE = **hamba_ act_ Manner** (e_1, x)

Hierarchy of semantic concepts

Walk - Manner - Motion - Event

The lexical semantic representation of **umhambo** (travelling) in (6) above can be explained similarly to **ihambo** in (5), the only difference being that the feature of [derogatory] in the reference to the event is absent, and the feature of [Manner] occurs. Thus, the nominalisation **umhambo** has three arguments in its argument structure (ARGSTR), of which two are default arguments, representing the physical object that moves, and the location at / in which the movement takes place respectively. The other argument is the reference of the event of walking by itself.

Class 11

Prefix: **u(lu)-**

Suffix: **-o**

umhambo ((event of) travel)

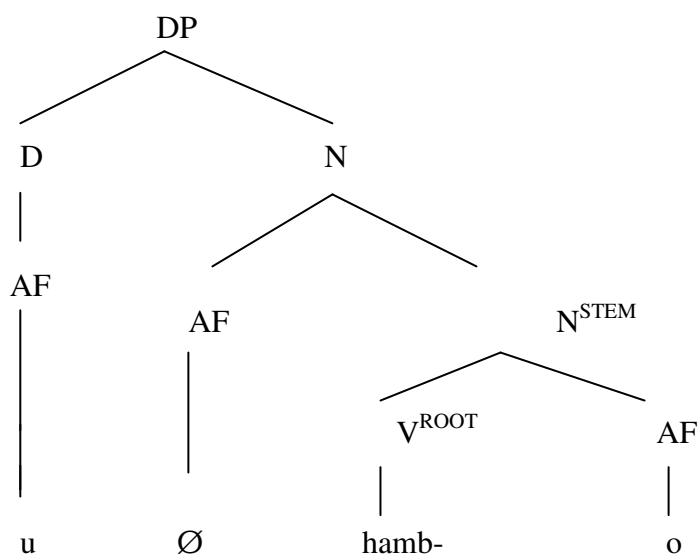

Nominalisation in class 11

uhambo ((event of) travel)

7. Uhambo lwabo luyathandwa ngabantu.
(Their travel is liked by the people).

uhambo	
ARGSTR	= ARG 1 = $x : e : r$ D – ARG 1 = $x : \text{phys(ical) object}$ D – ARG 2 = $y : \text{location}$
EVSTR	= D - E 1 = $e_1 : \text{process}$
QUALIA	= FORMAL = hamba _ event (e_r , x, y) AGENTIVE = hamba _ act (e_1 , x)

Hierarchy of semantic concepts

Walk - Motion - Event

The lexical semantic representation of **uhambo** in (7) above can be explained in a similar way to **ihambo** in (5) above, with the only difference specified in the formal quale in which the event of walking is presented. The noun **uhambo** in (7) above, refers to a stage level nominal which is defined with respect to a particular event.

Observation regarding the analysis of motion verbs

- A. All the motion verbs from IsiXhosa in the table above can be analysed analogously to the analysis presented for the verb **-hamba** above, except for the argument denoting a physical object in (1), with other motion verbs this argument may be only animate, for example the motion verbs in the table may all have a default argument which expresses location. The event structure (EVSTR) specification of these motion verbs is a process event. The qualia features exhibit a formal and an agentive feature which is the same for all nominals derived from motion verbs.

B. **Nominalisation in class 1 :**

The presence of the prefix **um-** and the suffix **-i** compositionally realise an interpretation of human for **umhambi**. The analysis is the same as that for (1) in other respects.

C. **Nominalisation in class 5** with the suffix **-i**

The analysis resembles that of the deverbative in class 1 presented in (2) above. The prefix **i(li-)** of class 5 introduces a semantic feature of [derogatory] and the suffix **-i** denotes human.

D. **Nominalisation in class 7** with suffix **-i**

The class 7 deverbative with the suffix **-i** also realises the semantics of a human. The analysis of class 7 deverbative is similar to that of class 1 nominalisation with the difference relating to the agentive quale which exhibits the feature [intensive] introduced by the prefix **isi-** of class 7.

E. **Nominalisation in class 3**

The argument of **umhambo** in class 3 in (8) above refers to the manner of walking or travelling. This argument is reflected in the formal quale as (e_r, x, y) to refer to the event of walking. In addition, the feature [Manner] appears in the agentive quale.

F. **Nominalisation in class 5** with the suffix **-o**

The argument of **ihambo** refers to the event or act of walking ($r =$ reference, $e =$ event). This argument is specified in the formal quale as (e_r, x, y) . The analysis in (7) is similar to that of class 3 **umhambo** in (8) above, with the exception that the feature of [Manner] specified for the latter does not occur with the former deverbative, i.e. class 5 **ihambo** in its agentive quale.

G. **Nominalisation in class 11** with the suffix **-o**

The class 11 nominalisation **uhambo** can be compared with the analysis of in (7) and (8) above. The agentive quale feature for **uhambo** specifies the feature [act] and the formal quale specifies the feature event.

- H. For nominals derived from motion verbs, there is no difference in terms of interpretation in regards to class 1 and class 7, as all deverbative nouns derived from these classes denote [Human] where the nominal suffix is **-i**. The only difference can be found in class 5 where different nominal suffixes **-i** or **-o** can be found. The deverbatives derived from motion verbs in class 5 have different interpretations if the suffixes are different. A deverbative noun with the suffix **-i**, **ihambi**, in class 5 denotes [Human] with a derogatory interpretation, as is illustrated in (4) above, whereas **ihambo** with the suffix **-o** denotes an act of travelling.

In summary, the examples of deverbatives derived from intransitive motion verbs show that there are very few deverbatives in class 5 derived from intransitive motion verbs, only two deverbatives **ihambi** and **ihambo** are found as can be observed in the schematic semantic representation in sub-section 4.2.2 of chapter 4. The deverbative where the nominal suffix is **-i** denotes count nouns whereas the deverbative whose nominal suffix is **-o** denotes cognition. In this group of intransitive motion verbs only two deverbatives in class 5 are derived from the intransitive motion verb **hamba**. There seems to be some regularity on the prevalence of deverbatives in class 7 and class 9 derived from intransitive motion verbs. The deverbatives in class 7 and class 9 denote count nouns where the nominal suffix is **-i**.

The deverbatives denoting humans can readily be associated with corresponding plurals, however, the deverbatives in class 9 which have other semantic features do not readily take a plural, as can be illustrated with the irregular deverbative ***iinkxumo**. It is evident that the set of lexical semantic representations of the range of nominals derived from the transitive put verbs with a locative argument in sub-section 4.2.2 of chapter 4 can be analysed in terms of a similar lexical semantic representations presented in sub-section 5.2.2 of chapter 5 as is demonstrated in the analysis of the motion verb **hamba** in sub-section 5.2.2 above.

5.2.3 Verbs relating to the body (Bodily processes)

In section 4.2 sub-section 4.2.3 the verbs relating to the body were analysed in terms of their deverbatives, and Levin (1993) described these verb classes in chapter 4. The verbs relating to the body (bodily processes) as explained in sub-section 4.2.3 of chapter 4 display the lexical schematic representation below which demonstrates various deverbatives from the following noun classes 1, 3, 5 7/8, 9 and 11. In the following section 5.2 sub-section 5.2.3 the deverbatives from the verbs **thimla** and **gula** are examined in terms of their use. The various deverbatives derived from the intransitive verbs relating to the body **thimla** and **gula** demonstrate a semantic type such as Person, Event, Action/Result and Manner as specified in sub-section 5.2.3 of chapter 5.

Nominalisation with the verb **-thimla** (sneeze)

The verb **-thimla** (sneeze)

1. Umfundi uyathimla.
(The student sneezes).

<p>-thimla</p> <p>ARGSTR = ARG 1 = x : sneeze</p> <p>EVSTR = E 1 = e₁ : process</p> <p>QUALIA = FORMAL = X</p> <p style="text-align: right;">AGENTIVE = -thimla _ sneeze (e₁, x) _</p>
--

Hierarchy of semantic concepts

Sneeze - Process

The lexical semantic representation of the verb relating to the bodily process **-thimla** can be explained as displaying only one argument in its argument structure (AGRSTR). This argument denotes the entity performing the sneezing. The event structure shows that the verb expresses a process of sneezing. The formal quale signifies the identity of the physical object (X) and the agentive quale which denotes the process of sneezing (e₁) of a person (X).

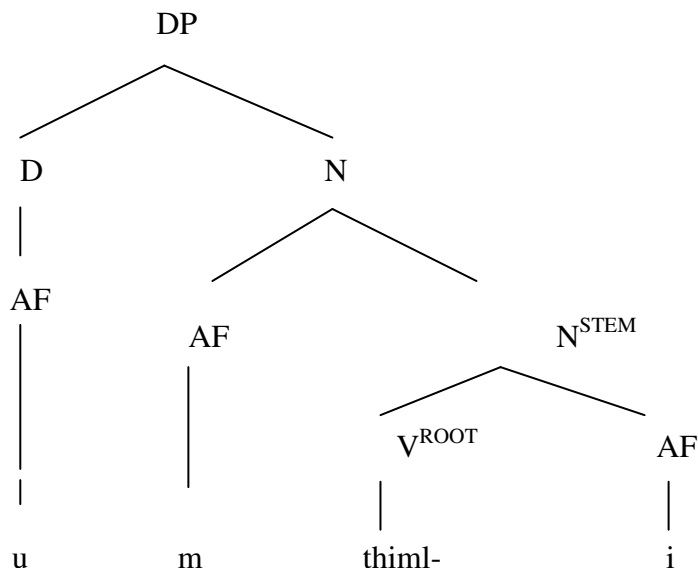
Class 1Prefix: **um-**Suffix: **-i****umthimli** (a person who sneezes)**Nominalisation in class 1****umthimli** (a sneezing person)

2. Umthimli ulele.
(The sneezing person is asleep).

umthimli	
ARGSTR	= ARG 1 = x : human
EVSTR	= D E 1 = e ₁ : process
QUALIA	= FORMAL = X
	AGENTIVE = -thimla _ act (e ₁ , x)

Hierarchy of semantic concepts

Sneeze - Process - Actor - Human

The lexical semantic representation of the deverbative noun **umthimli** (sneezing person) in (2) demonstrates that there is only one argument in its argument structure (ARGSTR), the one argument is the human who sneezes. The event structure (EVSTR) represents the default process event of sneezing. The qualia features display the formal quale denoting the identity

of the human argument (X), and the agentive quale, which denotes the act (process) of sneezing (e_1) of a person (X).

Class 3

Prefix: **um-**

Suffix: **-o**

umthimlo (manner of sneezing)

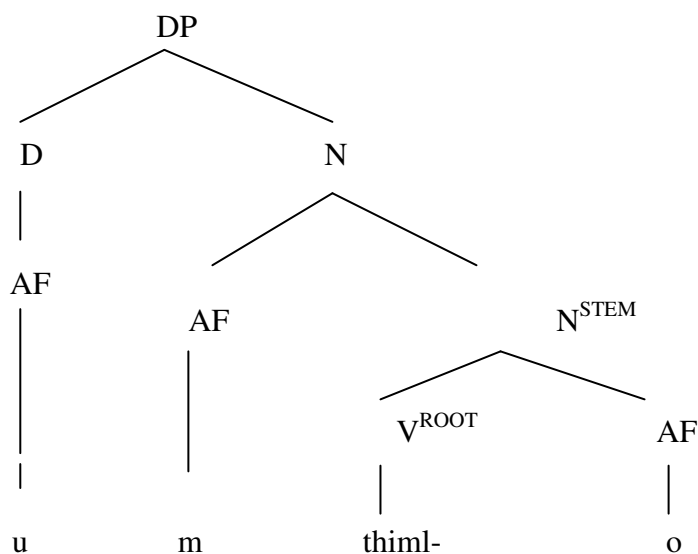

Nominalisation in class 3 [Manner]

umthimlo (manner of sneezing)

3. Umthimlo womntwana uphelile.

(The sneezing of the child has stopped).

umthimlo

ARGSTR = ARG 1 = $x : e : r$

D – ARG 1 = $x : \text{phys(ical) object}$

EVSTR = D - E 1 = $e_1 : \text{process}$

QUALIA = FORMAL = X

AGENTIVE = **thimla**_Manner (e_1, x)

Hierarchy of semantic concepts

Sneeze - Manner - Process - Event

The lexical semantic representation of **umthimlo** (sneezing) in (3) above demonstrates that there are two arguments in its argument structure (ARGSTR), one of which is a default argument, denoting the physical object that performs the act of sneezing. The other argument is the reference (r) of the event of sneezing. The qualia feature displays the formal quale denoting the identity of the human argument (X), and the agentive quale bears the feature [Manner] of sneezing (e_1) of a person (X). The deverbative noun **umthimlo** in class 3 can appear with a genitive NP, as is shown in (3) above.

Prefix: **isi-**

Suffix: **-i**

isithimli (sneezing person)

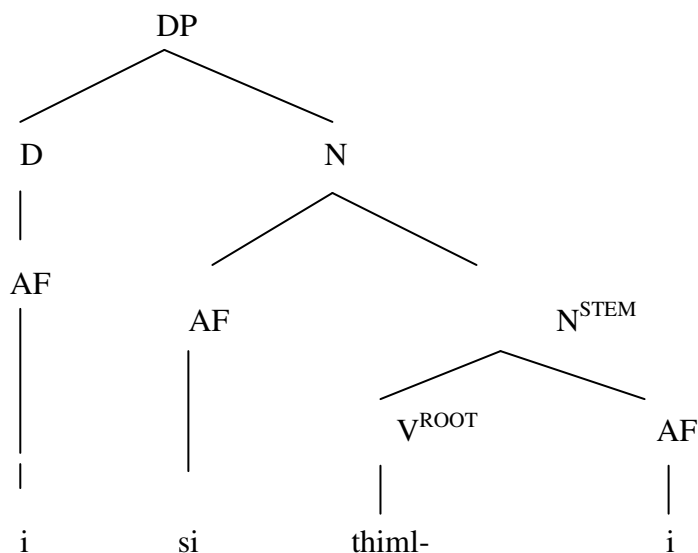

Nominalisation in class 7

isithimli (a habitually sneezing person)

4. Isithimli sendoda silele.

(The habitual sneezing person is sleeping).

isithimli	
ARGSTR	= ARG 1 = human
EVSTR	= D - E 1 = e_1 : process
QUALIA	= FORMAL = X
	AGENTIVE = thimla _act_intensive (e_1 , x, y)

Hierarchy of semantic concepts

Walk - Intensive - Motion Actor – Human

The lexical semantic representation of the deverbative noun **isithimli** in (3) above, can be explained in a similar way to the representation of **umthimli** in (2) above. The only difference relates to the agentive quale which in addition has the feature [Intensive] to the act of sneezing. The event structure (EVSTR) represents the default process event of sneezing. The deverbative noun **isithimli** can appear as a head in a NP, cognate noun as is illustrated in (4) above.

Class 9

Prefix: **in**

Suffix: **- o**

intimlo (sneezing)

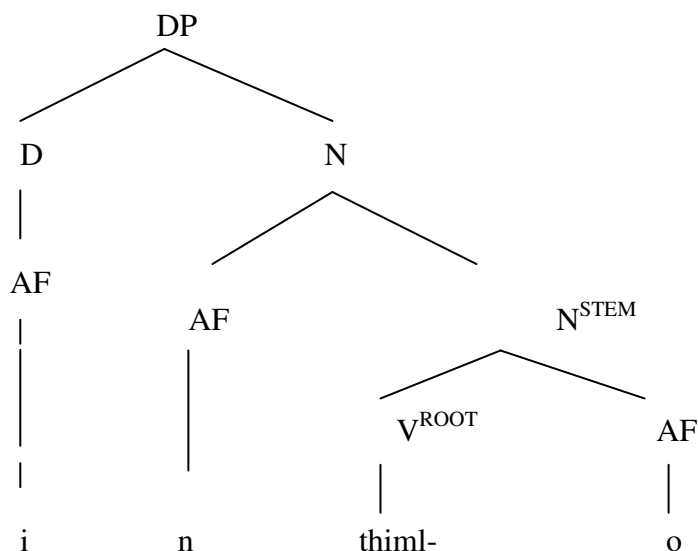

Nominalisation in class 9

intimlo (sneezing)

5. Intimlo yenja iphelile.

(The sneezing of the dog has ended).

intimlo	
ARGSTR	= ARG 1 = e : r D - ARG 1 = x : phys(ical) object)
EVSTR	= D - E 1 = e ₁ : process
QUALIA	= FORMAL = X
	AGENTIVE = -thimla _ Result (e ₁ , x)

Hierarchy of semantic concepts

Sneezing - Process - Result

The lexical semantic representation of **intimlo** in (5) above can be explained in a similar way to (3) above, with the only difference specified in the formal quale in which the feature [Result] is present. The deverbative **intimlo** in (5) above, refers to an individual level nominal which is defined with respect to a particular event.

Class 11

Prefix: **u (lu)**

Suffix: **-o**

uthimlo (sneezing)

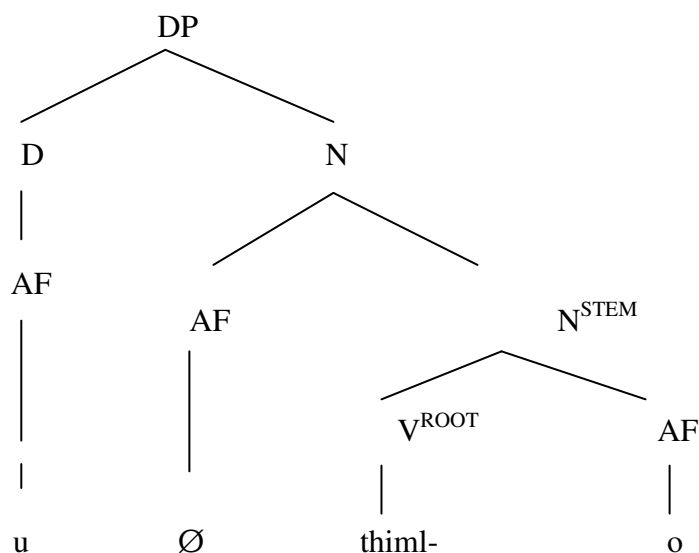

Nominalisation in class 11

uthimlo sneezing

6. Uthimlo luphelile.
(The sneezing has ended).

<p>uthimlo</p> <p>ARGSTR = ARG 1 = e : r</p> <p>EVSTR = D - E 1 = e₁ : process</p> <p>QUALIA = FORMAL = X</p> <p style="text-align: right;">AGENTIVE = -thimla _ Event (e₁ , x)</p>

Hierarchy of semantic concepts

Sneeze - Process - Event

The lexical semantic representation of **uthimlo** in (6) above exhibits only one argument in its argument structure, of which the reference (r) of the event of sneezing is that argument. The event structure represents the default process of sneezing. In the formal quale the event (process) of sneezing is presented.

Observation regarding the analysis of verbs relating to the body:

The above analysis of deverbatives derived from verbs relating to the body demonstrate that:

- A. Verbs relating to the body take an animate argument, the event is a process, and one formal quale occurs in terms of which the animate argument is in a process (of sneezing) (e₁ , x).

B. Nominalisation in class 1

The analysis reflects the analysis of the verb **thimla** in (1) above, except that the argument is only human, hence the semantic concept refers to this feature, that is [human]. The presence of the prefix **um-** and the suffix **-i** compositionally realise an interpretation of human for **umthimli**.

C. **Nominalisation in class 3**

The argument **umthimlo** in class 3 in (3) above refers to the process of sneezing. The argument is reflected in the formal quale (x) to refer to the event of sneezing. In addition the feature [Manner] appears in the agentive quale.

D. **Nominalisation in class 7**

The class 7 deverbative with the suffix **-i** denotes the feature human. The analysis of class 7 deverbative is similar to that of the class 1 nominalisation, but the only difference relates to the agentive quale which displays the feature [Intensive] introduced by the prefix **isi-** in class 7.

E. **Nominalisation in class 9**

The class 9 deverbative **intimlo** can be compared with the analysis in (3) above. The only difference pertains to the fact the class 9 deverbative is specified for the feature [Result] introduced by the prefix **in-** in class 9. The deverbative noun **intimlo** refers to an individual level nominal which is defined to a particular event.

F. **Nominalisation in class 11**

The argument **uthimlo** in class 11 can be analysed in a similar way to (3) above. The only difference relates to the agentive quale which exhibits the feature [Event] introduced by the prefix **u(lu-)**. In class 11 the deverbative noun **uthimlo** refers to a stage level nominal which is defined to a particular event.

G. The deverbatives derived from verbs relating to the bodily process can be interpreted in the same way when they are compositionally derived in the same manner in their respective classes. The only difference can be found in circumstances where a different nominal suffix is found within the same noun class, as in class 7 **isikhohlela** (phlegm) and class 11 **intimlo** respectively. Most deverbative nouns derived from class 7 denote a (habitual) person where the nominal suffix is **-i**. Where the nominal suffix is **-a**, a different interpretation which is not human is exhibited, as can be illustrated in the lexical semantic representation of **isikhohlela** (phlegm) below:

isikhohlela	
ARGSTR	= ARG 1 = x : e : r D – ARG 1 = x : human
EVSTR	= D - E 1 = e ₁ : process
QUALIA	= FORMAL = X AGENTIVE = khohlela _ Result (e ₁ , x)

The deverbative nouns in class 9 denote an expert person where the nominal suffix is –**i**, but in circumstances where the nominal suffix is –**o**, a different interpretation is exhibited, as can be illustrated in the lexical semantic representation of **intimlo** (sneezing) below:

intimlo	
ARGSTR	= ARG 1 = x : e : r D – ARG 1 = x : human
EVSTR	= D - E 1 = e ₁ : process
QUALIA	= FORMAL = X AGENTIVE = thimla _ Result (e ₁ , x)

ugulo	
ARGSTR	= ARG 1 = e : r D – ARG 1 = x : phys. obj.
EVSTR	= D E 1 = e ₁ : state
QUALIA	= FORMAL = X AGENTIVE = -gula _ result (e ₁ , x)

The lexical semantic representation of **ugulo** in (6) above can be explained similarly to **ingulo** in (5), the only difference being that the feature [state] in reference to the event is absent and the feature of [Result] occurs. Thus, the nominalisation **ugulo** has two arguments in its argument structure; the first argument illustrates the reference (r) of the result of sickness by itself. The other argument represents a default argument appearing as a physical object in the form of a descriptive possessive **lomntwana**. The event structure represents the default state event of the sickness. The qualia features display the formal quale denoting the identity of the

human argument (X), and the agentive quale, which denotes the result (state) of the sickness (e_1) of a person (X).

Observation regarding the analysis of verbs relating to bodily damage

The above analysis of deverbatives derived from verbs relating to bodily damage from IsiXhosa can be analysed analogously in the following way:

A. All verbs relating to bodily damage take an animate argument, the verb is a state, and one formal quale occurs in terms of which the animate argument is in a state (of sickness) (e_1, x).

B. Nominalisation in class 1

The analysis demonstrates the verb **gula** in (1), except that the argument is human, hence the semantic concept refers to this feature, that is [Human]. The presence of the prefix **-um** and the suffix **-i** compositionally realise an interpretation of human for **umguli**.

C. Nominalisation in class 7

The **class 7** deverbative with the suffix **-i** denotes the feature human, whereas the one with the suffix **-o** exhibits an argument that illustrates the reference (r) of the manner of sickness by itself. The analysis of class 7 deverbative is similar to that of class 1 nominalisation, but the only difference relates to the agentive quale which displays the feature [Intensive] for **isiguli** and the [Manner] feature for **isigulo** respectively.

D. Nominalisation in class 9

The **class 9** deverbative **ingulo** can be compared with the analysis in (3) above. The only difference relates to the agentive quale which displays the feature [State] for **ingulo**.

E. Nominalisation in class 11

The argument **ugulo** in class 11 can be analysed in a similar way to (5) above. The only difference relates to the agentive quale which displays the feature [Result] introduced by the prefix **u(lu-)** which is absent in (5) above.

It can be observed as is shown in the lexical semantic representation in sub-section 4.2.3 of chapter 4 that the examples of deverbatives derived from intransitive verbs relating to bodily processes demonstrate that deverbatives that are most prevalent are in class 1 and class 7/8. These deverbatives denote humans where the nominal suffix is **-i**, and if the nominal suffix is **-a**, very few deverbative nouns are able to exhibit a human denotation except for class 5 deverbal noun **idangala** and **isiqhwala / iziqhwala** in classes 7/8 respectively. In instances where the nominal suffix is **-o** in class 7 such deverbatives do not have a human denotation, as can be illustrated in the lexical semantic representation of **isigulo** (sickness).

isigulo	
ARGSTR	= ARG 1 = e : r D - ARG 1 = animate
EVSTR	= D - E 1 = e ₁ : state
QUALIA	= FORMAL = X AGENTIVE = gula_ manner (e ₁ , x, y)

In summary, this group of intransitive verbs relating to bodily processes has only one deverbative **ilila** in class 5 which is derived from the verb **lila** as is illustrated in the lexical schematic representation in sub-section 4.2.3 of chapter 4.. This deverbative denotes human where the nominal suffix is **-a**. There seems to be some regularity on the prevalence of deverbatives derived from class 7 and class 9 in intransitive verbs relating to bodily processes. The deverbatives in class 7 and class 9 denote count nouns where the nominal suffix is **-i**.

There is a small number of deverbatives in class 7 and class 9 where the nominal suffix is **-o**, and these deverbatives denote action or result. The number of deverbatives in class 7 and class 9 where the nominal suffix is **-a** is very low, and the meaning denoted is action or result. The deverbatives denoting humans where the nominal suffix is **-i** can readily be associated with corresponding plural nouns, however, the deverbatives in class 9 which have

other semantic features do not readily take a corresponding plural form, as can be shown with atypical deverbatives ***iintsico** and ***iintsuzo**, respectively. In most cases the deverbatives that are derived in class 11 have an event denotation.

It is evident that the set of lexical semantic representations of the range of nominals derived from the transitive put verbs with a locative argument in sub-section 4.2.3 of chapter 4 can be analysed in terms of a similar lexical semantic representations presented in sub-section 5.2.3 of chapter 5 as is demonstrated in the analysis of the put verb **gula** in sub-section 5.2.3 above.

5.2.4 Experiencer verbs

In section 4.2 sub-section 4.2.1 the experiencer verbs were analysed in terms of their deverbatives, and Áfarli (2002) described these verb classes in sub-section 4.2.4 of chapter 4. The experiencer verbs as explained in section 4.2.4 of chapter 4 display the lexical schematic representation below which demonstrates various deverbatives from the following noun classes 1, 3, 5, 7/8, 9 and 11. In the following section 5.2 sub-section 5.2.2 the deverbatives from the verb **qumba** are examined in terms of their use. The various deverbatives derived from the intransitive state verb **qumba** demonstrate a semantic type such as Person, Event, Action/Result and Cognition as specified in sub-section 5.2.4 of chapter 5.

nominalisation with the verb –qumba (be angry / annoyed)

qumba (be angry / annoyed)

1. Ootata baqumbile.
(The fathers are angry).

<p>-qumba ARGSTR = ARG 1 = x : phys. obj. EVSTR = D E 1 = e₁ : state QUALIA = FORMAL = X AGENTIVE = -qumba _ state (e₁ , x, y)</p>
--

Hierarchy of semantic concepts

qumba - angry - experiencer

The lexical representation of **qumba** can be explained as having one argument, which is a physical object, specifically a human. The event structure of the verb **qumba** specifies the state of being angry. The qualia features include the formal quale which specifies the identity of the physical object (X), and the agent quale specifies the state of being angry of the person (X).

Class 1

Prefix: **um-**

Suffix: **-i**

umqumbi (a person who is angry)

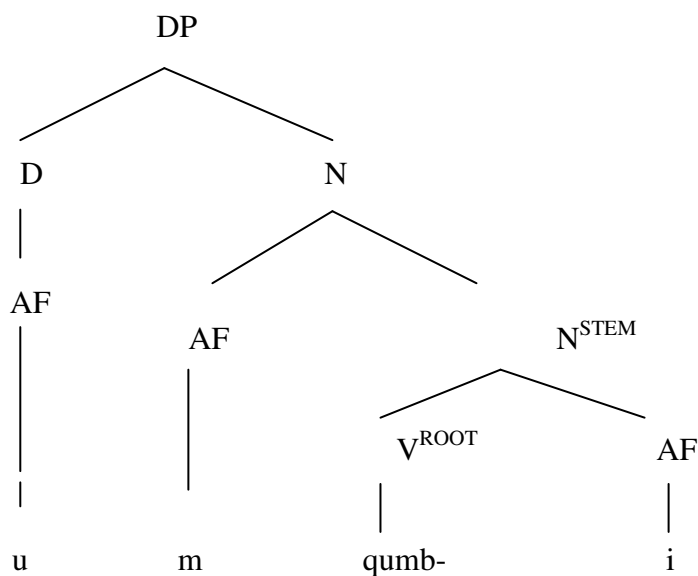

Nominalisation in class 1

umqumbi (person who is angry)

2. Umqumbi uyoyika.
(The angry person is scared).

umqumbi	
ARGSTR	= ARG 1 = x : human
EVSTR	= D E 1 = e ₁ : state
QUALIA	= FORMAL = (er, x)
	AGENTIVE = -qumba _ state (e ₁ , x)

Hierarchy of semantic concepts

Be angry - Experiencer - Human

The lexical semantic representation of **umqumbi** displays one argument in its argument structure. The event structure specifies the default event (or situation) of state. The qualia structure specifies the formal quale expressing the identity of the human argument (x) and the agentive quale which represents the state of being angry of a person.

Class 5

Prefix: **i(li-)**

Suffix: **-a**

iqumba (an angry person)

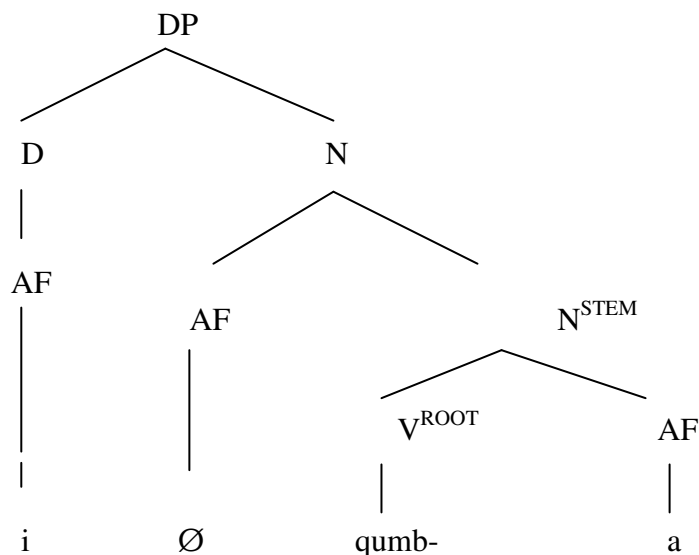

Nominalisation in class 5

iqumba (person who is angry - derogatory)

3. Iqumba libalekile.
(The angry person ran away)

iqumba	
ARGSTR	= ARG 1 = x : human
EVSTR	= D E 1 = e ₁ : state
QUALIA	= FORMAL = x (derogatory)
	AGENTIVE = -qumba _ state (e ₁ , x)

Hierarchy of semantic concepts

Be angry - Experiencer - Human (derogatory)

The lexical semantic representation of **iqumba** displays one argument in its argument structure (ARGSTR). The event structure represents the default event of the state of being angry. The qualia features include the formal quale, specifying the identity of the human argument (x), and the agentive quale specifying the state of being angry of a person. The formal quale has the feature [derogatory], which is absent in (1) above.

Class 7

Prefix: **isi-**

Suffix: **-i**

isiqumbi (an intensely angry person)

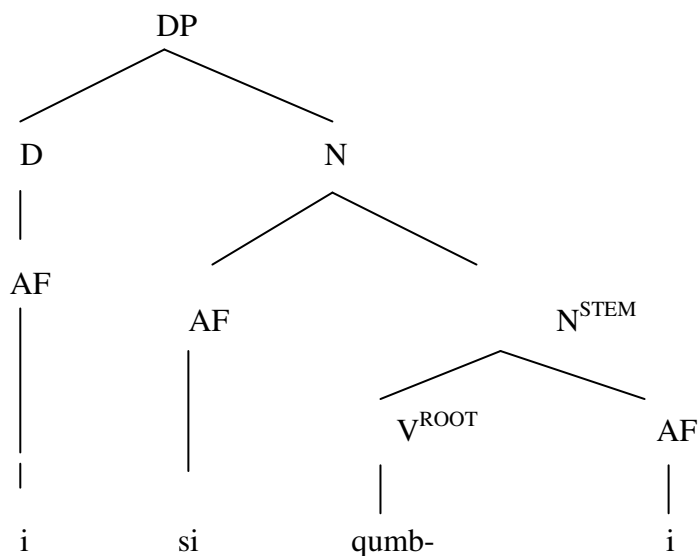

Nominalisation in class 7

isiqumbi (an intensely angry person)

4. isiqumbi siyaboyikisa abantu.
(The intensely angry person scares people).

isiqumbi	
ARGSTR	= ARG 1 = x : human
EVSTR	= D E 1 = e ₁ : state
QUALIA	= FORMAL = x (intensely)
	AGENTIVE = -qumba _ state (e ₁ , x)

Hierarchy of semantic concepts

Be angry - Experiencer - Human (Intensive)

The lexical semantic representation of **isiqumbi** in (4) above can be compared similarly with the analysis in (1) and (2) respectively. The only difference pertains to the fact that the class 7 deverbative **isiqumbi** is specified in the formal quale with the feature [intensive] which is absent in (1) and (2) respectively. Thus, the qualia structure specifies the formal quale expressing the identity of intensely angry person (x) and the agentive quale which represents the state of being angry of a person.

Class 9

Prefix: **in-**

Suffix: **-o**

ingqumbo (extreme anger, wrath)

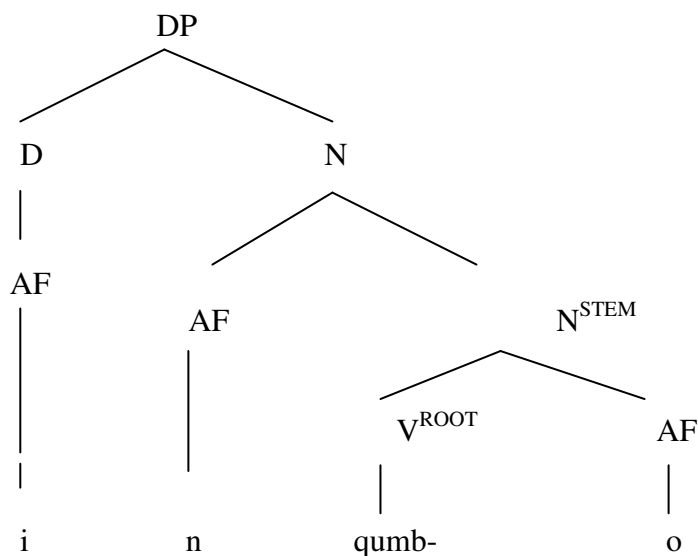

Nominalisation in class 9

ingqumbo (extreme anger, wrath)

5. Ingqumbo yabantu iyoyikeka.

(The wrath / anger of the people is fearful).

ingqumbo	
ARGSTR	= ARG 1 = e : r D - = x : phys. obj.
EVSTR	= D E 1 = e ₁ : state
QUALIA	= FORMAL = qumba _ result (e _r , x) AGENTIVE = -qumba _ state (e ₁ , x)

Hierarchy of semantic concepts

Be angry - Experiencer - Result

The lexical semantic representation of **ingqumbo** (anger, wrath) in (5) above can be explained with reference to two arguments, of which one is a default argument, namely the physical object that displays anger. The other argument is the reference of the state event of being angry, and the agentive quale represents the state of being angry of a person (x).

Class 11

Prefix: **u(lu-)**

Suffix: **-o**

uqumbo (anger)

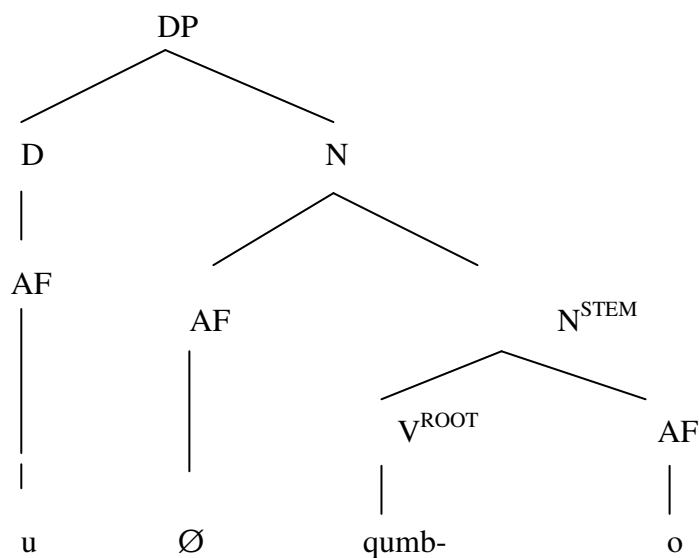

Nominalisation in class 11

uqumbo (anger)

6. Uqumbo lwabantu lwamangalisa umfundisi.
(The anger of the people surprised the minister).

uqumbo	
ARGSTR	= ARG 1 = e : r D - = x : phys. obj.
EVSTR	= D E 1 = e ₁ : state
QUALIA	= FORMAL = qumba _ state (e _r , x)
	AGENTIVE = - qumba _ state (e ₁ , x)

Hierarchy of semantic concepts

Be angry - Experiencer - State

The lexical semantic representation of **uqumbo** in (6) above resembles that of (5). The only difference relates to (5) representing a result of the state while (6) represents the state only.

Viewed as a whole, the semantic concepts of the nominalisations of the verb **qumba** are as follows:

- A. All verbs relating to experiencer verbs take an animate argument, and one formal quale occurs in terms of which the animate argument is in a state (of anger) (e₁, x).
- B. **Nominalisation in class 1**

The analysis shows the verb **qumba** in (1), except that the argument is human, hence the semantic concept refers to this feature, that is [Human]. The presence of the prefix **-um** and the suffix **-i** compositionally realise an interpretation of human for **umqumbi**.

C. **Nominalisation in class 7**

The analysis of class 7 deverbative is similar to that of class 1 nominalisation, but the only difference relates to the agentive quale which displays the feature [Intensive] for **isiqumbi** in class 7 but that is not the case in class 1.

D. **Nominalisation in class 9**

The **class 9** deverbative **ingqumbo** demonstrates in its agentive quale the feature [Result]..

E. **Nominalisation in class 11**

The argument **uqumbo** in class 11 can be analysed in a similar way to class 9 above. The only difference relates to the agentive quale which displays the feature [State] which absent in class 9.

F. The examples of deverbatives derived from intransitive experiencer verbs show that deverbatives that are most prevalent are in class 1 and class 7/8. These deverbatives denote humans where the nominal suffix is **-i**, and if the nominal suffix is **-a** only class 5 deverbative nouns are able to exhibit a human denotation, as can be illustrated in the lexical semantic representation of **iqumba** (angry person).

iqumba	
ARGSTR	= ARG 1 = e : r
EVSTR	= D - E 1 = e ₁ : state
QUALIA	= FORMAL = X
	AGENTIVE = qumba _ derogatory (e ₁ , x, y)

In summary, the examples of deverbatives derived from intransitive experiencer verbs demonstrate that these deverbatives are most prevalent in class 7. These deverbatives denote count nouns where the nominal suffix is **-i**. There is a small number of deverbatives in class 5 **iqumba**, **ivuya**, **idana** which also denote count nouns but have a nominal suffix **-a** as is

illustrated in the lexical schematic representation in sub-section 4.2.4 of chapter 4. There is a small number of deverbatives in class 9 where the nominal suffix is **-o**, and these deverbatives denote state. The deverbatives in this group of intransitive experiencer verbs seem to show that these verbs are more prevalent in class 7 and class 9.

The deverbatives denoting humans where the nominal suffix is **-i** can readily be associated with corresponding plural nouns, however, the deverbatives in class 9 which have other semantic features do not readily take a corresponding plural form, as can be shown with irregular deverbatives ***iingqumbo** and ***iimvuyo**, respectively. In most cases the deverbatives that are derived in class 11 have an event denotation. It is evident that the set of lexical semantic representations of the range of nominals derived from the transitive put verbs with a locative argument in sub-section 4.2.4 of chapter 4 can be analysed in terms of a similar lexical semantic representations presented in sub-section 5.2.4 of chapter 5 as is demonstrated in the analysis of the put verb **qumba** in sub-section 5.2.4 above.

5.2.5 Weather verbs

In the following section 5.2 sub-section 5.2.5 the deverbatives from the verb **vuthuza** are examined in terms of their use. The various deverbatives derived from the intransitive weather verb **vuthuza** demonstrate a semantic type such as Event, Action/Result, Instrument and Manner as specified in sub-section 5.2.5 of chapter 5. In section 4.2 sub-section 4.2.3 the verbs relating to the body were analysed in terms of their deverbatives, and Levin (1993) described these verb classes in chapter 4. The weather verbs as explained in sub-section 4.2.5 of chapter 4 display the lexical schematic representation below which demonstrates various deverbatives from the following noun classes 3, 7, 9 and 11.

Nominalisation with the verb **-vuthuza** (blow (of wind))

-vuthuza (blow (of wind))

with inanimate subjects

1. Umoya uyavuthuza.
(The wind is blowing).

-vuthuza	
ARGSTR	= ARG 1 = x : wind
EVSTR	= E 1 = e ₁ : process
QUALIA	= FORMAL = x
	AGENTIVE = -vuthuza _ act (e ₁ , x)

Hierarchy of semantic concepts

Blow (of wind) - weather

The lexical semantic representation of the weather verb **-vuthuza** demonstrates that **vuthuza** has only one argument in its argument structure (ARGSTR). This argument represents the blowing wind. The event structure (EVSTR) displays the process event of blowing. The formal quale represents the identity of the wind while the agentive quale represents the act (i.e process) of blowing the wind (x).

Class 3

Prefix: **um -**

Suffix: **- o**

umvuthuzo (manner of) blowing))

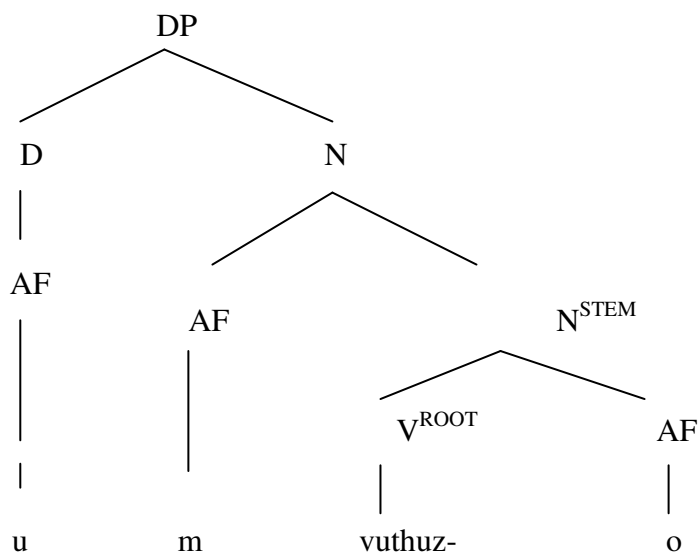

Nominalisation in class 3

Umvuthuzo (manner of (blowing))

2. Umvuthuzo wawisa imithi.

(The blowing of the wind fell trees).

umvuthuzo	
ARGSTR	= ARG 1 = e : r D – ARG 1 = x : inanimate
EVSTR	= E 1 = e ₁ : process
QUALIA	= FORMAL : x
	AGENTIVE = -vuthuza _act_manner (e ₁ , x)

Hierarchy of semantic concepts

Blowing - Process - Action

The lexical semantic representation of the deverbative noun **umvuthuzo** has two arguments in its argument structure, one of which is a default argument (i.e inanimate). The first argument displays reference (r) of the event or process of blowing. The formal quale represents the identity of the wind while the agentive quale represents the act (i.e process) of the blowing wind (wind (x)).

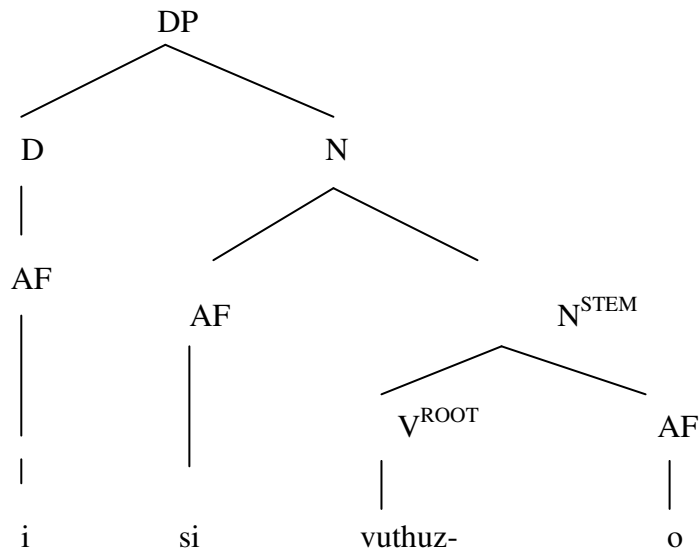
Class 7Prefix: **isi**Suffix: **-i****isivuthuzi** (a blowing instrument)**Nominalisation in class 7****isivuthuzi** (a blowing instrument)

3. Isivuthuzi sadala uthuli.

(The blowing instrument caused dust).

isivuthuzi	
ARGSTR	= ARG 1 = e : r
	D - ARG 1 = x : inanimate
EVSTR	= D - E 1 = e ₁ : process
QUALIA	= FORMAL = -vuthuza _ Instrument (e ₁ , x)

Hierarchy of semantic concepts

Blowing - Process - Instrument

The lexical semantic representation of **isivuthuzi** in (3) above can be explained in a similar way to (2) in regard to its argument structure (ARGSTR), with the only differences specified in the argument structure where the default argument is inanimate. The first argument ARG1, displays the reference (r) of the event (e) of a blowing instrument by itself. The event structure (EVSTR) demonstrates the default argument which is a process of an inanimate blowing instrument. The other difference specified in the formal quale relates to the presence

of the feature [Instrument]. The deverbative **isivuthuzi** in (3) above, refers to a stage level nominal which is defined with respect to a particular event.

Class 9

Prefix: **im**

Suffix: **-o**

imvuthuzo (blowing wind)

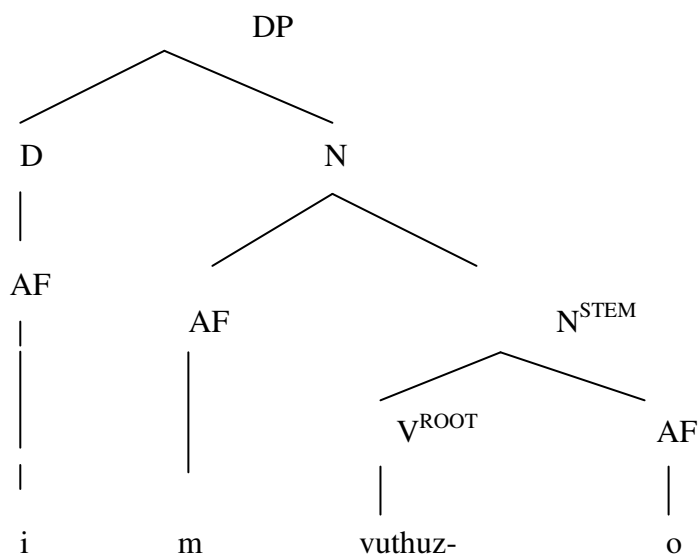

Nominalisation in class 9

imvuthuzo (a blowing wind)

4. Imvuthuzo yomoya yadala umonakalo.
(The blowing wind caused damages).

imvuthuzo	
ARGSTR	= ARG 1 = e : r
	D - ARG 1 = x : inanimate
EVSTR	= D - E 1 = e ₁ : process
QUALIA	= FORMAL = -vuthuza _ Result (e ₁ , x)

Hierarchy of semantic concepts

Blowing (wind) - Process - Result

The lexical semantic representation of **imvuthuzo** in (4) above can be explained in a similar way to (2) above, with the only difference specified in the formal quale in which the feature [Result] is present. The deverbative **imvuthuzo** in (4) above, refers to an individual level nominal which is defined with respect to a particular event.

Class 11

Prefix: **u (lu)**

Suffix: **-o**

uvuthuzo (blowing)

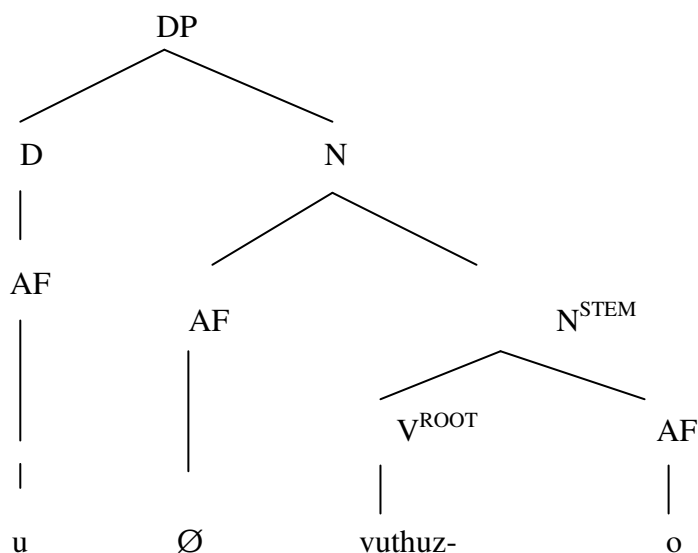

Nominalisation in class 11

uvuthuzo blowing (wind)

5. Uvuthuzo ludilize izindlu.

(The blowing wind has destroyed houses).

uvuthuzo	
ARGSTR	= ARG 1 = e : r
	D – ARG 1 = x : inanimate
EVSTR	= D - E 1 = e ₁ : process
QUALIA	= FORMAL = -vuthuza _ Event (e ₁ , x)

Hierarchy of semantic concepts

Blowing (wind) - Process - Event

The lexical semantic representation of **uvuthuzo** in (5) above can be explained in a similar way to (2) above, with the only difference specified in the formal quale in which the feature [Event] is present. The deverbative **uvuthuzo** in (4) above, refers to a stage level nominal which is defined with respect to a particular event.

Class 11

Prefix: **u (lu)**

Suffix: **-o**

ufefo (drizzling)

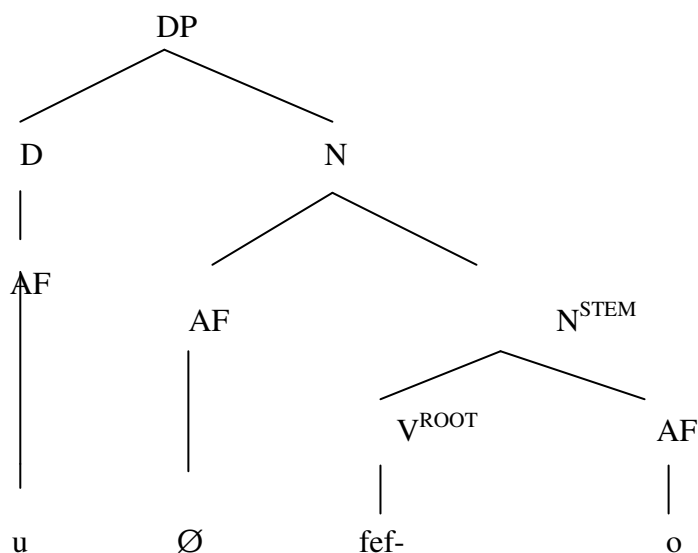

Nominalisation in class 11

ufefo (drizzling)

6. Ufefo lwabangela udaka.
(The drizzling caused mud).

ufefo	
ARGSTR	= ARG 1 = e : r
	D - ARG 1 = x : inanimate
EVSTR	= D - E 1 = e ₁ : process
QUALIA	= FORMAL = -fefa _ Event (e ₁ , x)

Hierarchy of semantic concepts

Drizzle - Process - Event

The lexical semantic representation of the deverbative noun **ufefo** in (4) above can be explained in a similar way to (3) above, with the only difference specified in the formal quale in which the feature [Event] is present. The noun **ufefo** in (3) above, refers to a stage level nominal which is defined with respect to a particular event.

Observation regarding the analysis of weather verbs:

The above analysis of deverbatives derived from weather verbs taking an inanimate subject demonstrate that:

A. Weather verbs take an inanimate argument, the event is a process, and one formal quale occurs in terms of which the inanimate argument is in a process (of blowing the wind) (e_1, x).

B. Nominalisation in class 3

The argument **umvuthuzo** in class 3 in (2) above refers to the process of blowing. The argument is reflected in the formal quale (x) to refer to the event of blowing. In addition the feature [act] appears in the agentive quale.

C. Nominalisation in class 7

The class 7 deverbative with the suffix **-i** denotes the feature inanimate. The analysis of class 7 deverbative is similar to that of class 3 nominalisation the only difference relates to the agentive quale which displays the feature [Instrument] introduced by the prefix **isi-** in class 7.

D. Nominalisation in class 9

The class 9 deverbative **imvuthuzo** can be compared with the analysis in (2) above. The only difference pertains to the fact the class 9 deverbative is specified for the

feature [Result] introduced by the prefix **im-** in class 9. The deverbative noun **imvuthuzo** refers to an individual level nominal which is defined to a particular event.

E. Nominalisation in class 11

The argument **uvuthuzo** in class 11 can be analysed in a similar way to (2) above. The only difference relates to the agentive quale which exhibits the feature [Event] introduced by the prefix **u(lu-)**. In class 11. The deverbative noun **uvuthuzo** refers to a stage level nominal which is defined to a particular event.

F. The examples of deverbatives derived from intransitive weather verbs demonstrate that most deverbatives are prevalent in class 9 and class 11 respectively. The deverbatives that are derived from class 9 denote [result] whereas those are derived from class 11 denote [Event, Manner]. In class 7 *isikhithizo* and *isivuthuzi* denote an [instrument] though they have a nominal suffix **-o** and **-i** respectively. Only one deverbative noun **umvuthuzo** in class 3 denotes manner. There are no deverbatives derived from class 1, class 5 and class 14 from weather verbs.

In summary, the examples of deverbatives derived from weather verbs demonstrate that these deverbatives are most prevalent in class 9 as is illustrated in sub-section 4.2.5 of chapter 4. These deverbatives have a nominal suffix **-o**, and they denote results. There is only one deverbative in class 7 **isivuthuzi** with the nominal suffix **-i**, and it denotes instrument. There are only two deverbatives in class 11, **ufefo** and **ugxigxizo**, with the nominal suffix **-o** and they denote event and manner of event, respectively. It is evident that the set of lexical semantic representations of the range of nominals derived from the intransitive weather verbs in sub-section 4.2.5 of chapter 4 can be analysed in terms of a similar lexical semantic representations presented in sub-section 5.2.5 of chapter 5 as is demonstrated in the analysis of the put verb **vuthuza** in sub-section 5.2.5 above.

5.2.6 Motion verbs with a locative argument

5.2.6.1 The locative refers to a location

In sub-section 4.2.2 of chapter 4 the motion verbs were analysed in terms of their deverbatives, and Levin (1993) described these verb classes. The motion verbs as explained in

sub-section 5.2.6 of chapter 5 display the lexical schematic representation below which demonstrates various deverbatives from the following noun classes 1, 3, 6, 7, 9, 11 and 14. In the following section 5.2 sub-section 5.2.6 the deverbatives from the verb **fika** are examined in terms of their use. The various deverbatives derived from the intransitive motion verb with a locative argument **fika** demonstrate a semantic type such as Person, Event, Action/Result, Artefact and Quality as specified in sub-section 5.2.6 of chapter 5.

Nominalisation from **-fika** (arrive)

The verb **fika** (arrive)

1. Umfundi ufikile esikolweni.
(The student arrived at school).

-fika	
ARGSTR	= ARG 1 = x : phys(ical) object D – ARG 1 = y : location
EVSTR	= E 1 = e ₁ : process E 2 = e ₂ : state Restr(ucturing) = Temporally ordered Head = e ₂
QUALIA	= FORMAL = at (e ₂ , x, y) AGENTIVE = -fika _ act (e ₁ , x)

Hierarchy of semantic concepts

Arrive - Location - Motion

The lexical semantic representation of **-fika** above displays two arguments in its argument structure (ARGSTR). One argument is the physical object that performs (or undergoes) the act of arriving and the other argument is a default argument representing the location at which the act of arriving takes place. The event structure (EVSTR) displays two events of which the state event (e₂) is the head. The qualia features display the formal quale, which specifies the state of arrival of a physical object at a location, and the agentive quale, which specifies the act (process) of arriving by the physical object(e.g. individual).

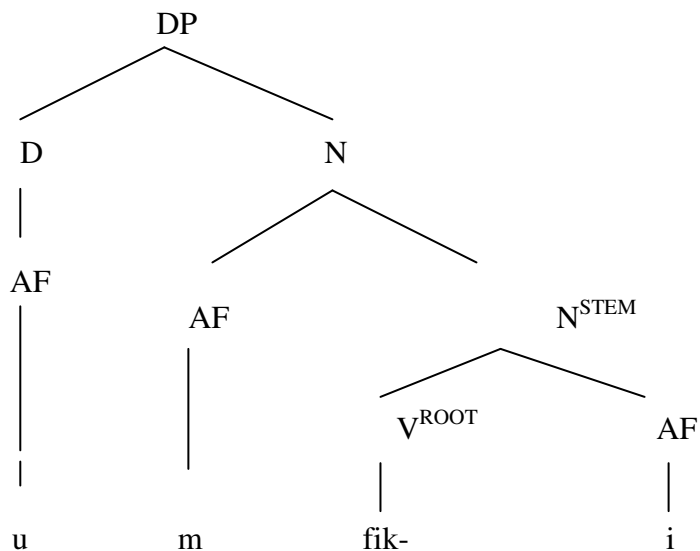
Class 1Prefix: **um-**Suffix: **-i****umfiki** (person who arrives)**Nominalisation in class 1****umfiki** (person who arrives)

2. Umfiki ulambile.
(The person who arrives is hungry).

-umfiki	
ARGSTR	= ARG 1 = x : phys(ical) object D – ARG 1 = y : location
EVSTR	= E 1 = e ₁ : process E 2 = e ₂ : state Restr = Temporally ordered Head = e ₂
QUALIA	= FORMAL = at (e ₂ , x, y) AGENTIVE = -fika _ act (e ₁ , x)

Hierarchy of semantic concepts

Arrive - Location - Motion - Human

The lexical semantic representation of the deverbative **umfiki** displays an argument structure (AGRSTR) containing two arguments. The one argument represents the person who arrives, and the other argument, a default argument, represents the location where the arriving takes place. The event structure exemplifies two default events, namely the process of arriving, and the resulting state. These events are temporally ordered and the state event (e_2) occurs as the head of the event structure. The qualia structure displays the formal quale, which represents the state of arriving of a human at a location. The agentive quale specifies the act (i.e process) of arriving by an individual.

Class 7

Prefix: **isi-**

Suffix: **-i**

Isifiki (a person who arrives)

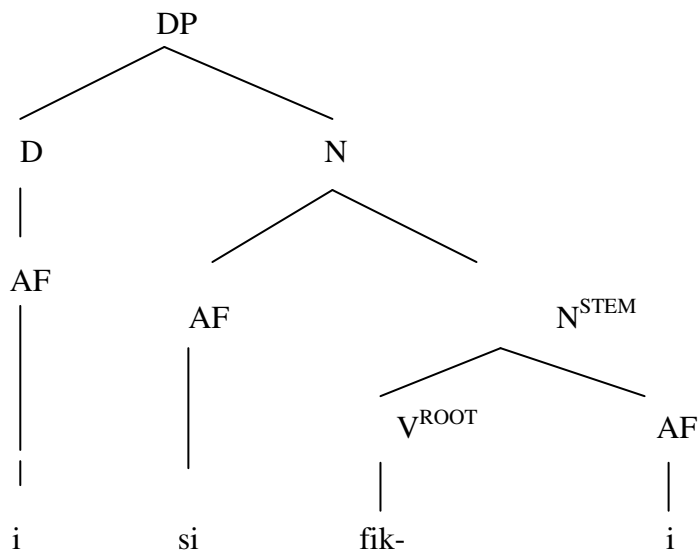

Nominalisation in class 7

isifiki (person who arrives)

3. Isifiki sinxaniwe.
(The person who arrives is thirsty).

isifiki	
ARGSTR	= ARG 1 = x : phys(ical) object D – ARG 1 = y : location
EVSTR	= E 1 = e ₁ : process E 2 = e ₂ : state Restr = Temporally ordered Head = e ₂
QUALIA	= FORMAL = at (e ₂ , x, y) AGENTIVE = -fika _ act_ intensive (e ₁ , x)

Hierarchy of semantic concepts

Arrive - Location - Intensive - Motion - Human

The explanation of the lexical semantic representation of **isifiki** is similar to that of **umfiki** in (2) above. The distinguishing difference is found in the formal quale which specifies the feature [Intensive] in (3), which is absent in (2).

Class 3

Prefix: **um-**
Suffix: **-o**
umfiko (arrival)

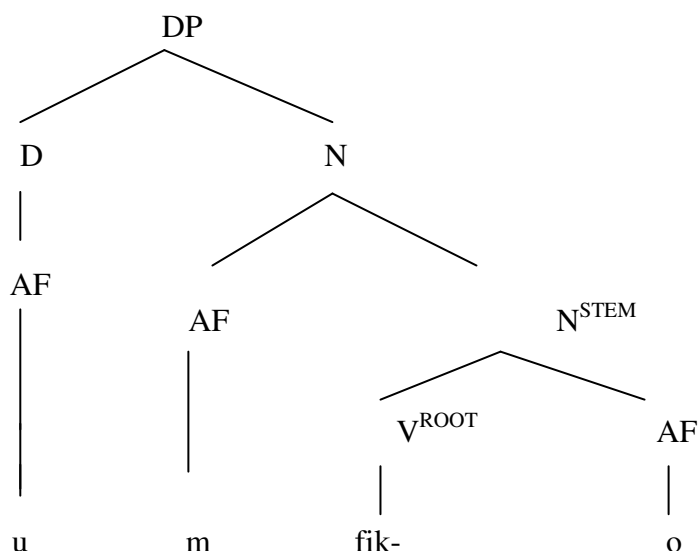

Nominalisation in class 3: Act / Event

umfiko (arrival)

4. Umfiko wabafundi esikolweni unconyiwe.
(The arrival of students at school is praised).

umfiko	
ARGSTR	= ARG 1 = e : r D – ARG 1 = X : phys. object) D – ARG 2 = y : location
EVSTR	= D - E 1 = e ₁ : process D - E 2 = e ₂ : state Restr = Temporally ordered Head = e ₂
QUALIA	= FORMAL = (e _r , x, y) AGENTIVE = -fika _ at (e ₁ , x)

Hierarchy of semantic concepts

Arrive - Location - Motion - Event

The lexical semantic representation of **-umfiko** above displays three arguments in its argument structure. Two of these arguments are default arguments. These are the physical object that arrives and the location at which the arrival occurs. The other argument is the reference (r) of the event of arriving by itself. The event structure (EVSTR) displays two default events, namely the process of arriving and the resulting state. These events are

temporally ordered and is headed by the state (e_2) event. The formal role in the qualia structure represents the act of arriving.

Nominalisation in class 3: Manner

umfiko (Manner of arriving)

5. Abantu bancoma umfiko wabadlali besoka.
(The people praised the way of arriving of the soccer players).

umfiko	
ARGSTR	= ARG 1 = $e : r$ D – ARG 1 = X : phys. object) D – ARG 2 = y : location
EVSTR	= D - E 1 = e_1 : process D - E 2 = e_2 : state Restr = Temporally ordered Head = e_2
QUALIA	= FORMAL = (e_r, x, y) AGENTIVE = -fika _ Manner (e_1, x) _

Hierarchy of semantic concepts

Arrive - Manner - Location - Motion - Event

The lexical semantic representation of **umfiko** (manner of arriving) has an explanation similar to that in (4) above. The distinguishing difference relates to the agentive quale, where in (5), the agentive quale is specified for the feature [Manner], which is absent in (4).

Class 9

Prefix: **im**

Suffix: **-o**

imfiko (arrival)

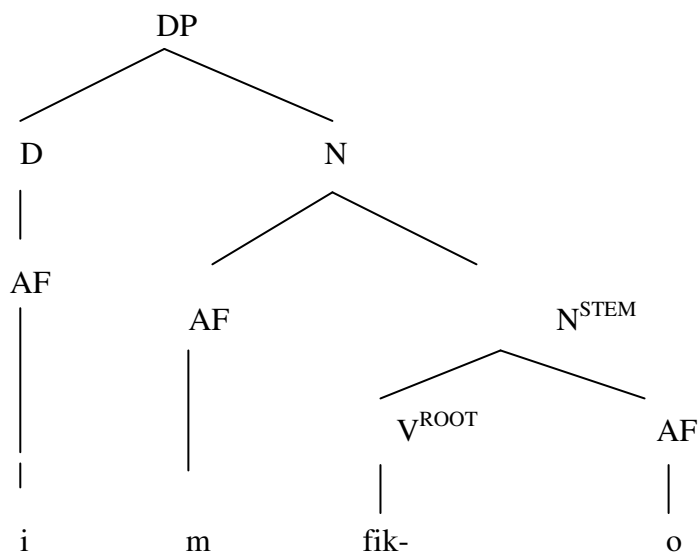

Nominalisation in class 9

imfiko (arrival)

6. Bonke abantu bathanda imfiko katitshala.
(All the people like the arrival of the teacher).

imfiko	
ARGSTR	= ARG 1 = e : r D – ARG 1 = X : phys. object) D – ARG 2 = y : location
EVSTR	= D - E 1 = e ₁ : process D - E 2 = e ₂ : state Restr = Temporally ordered Head = e ₂
QUALIA	= FORMAL = fika_ result (e ₁ , x, y) AGENTIVE = -fika_ act (e ₁ , x)

Hierarchy of semantic concepts

Arrive - Location - Motion - Result

The lexical semantic representation of **imfiko** in (6) above has an explanation similar to that in (4) above. The distinguishing difference relates to the formal quale, whereas the formal quale in (6) specifies the result of the event, the formal quale in (4) represents the event only.

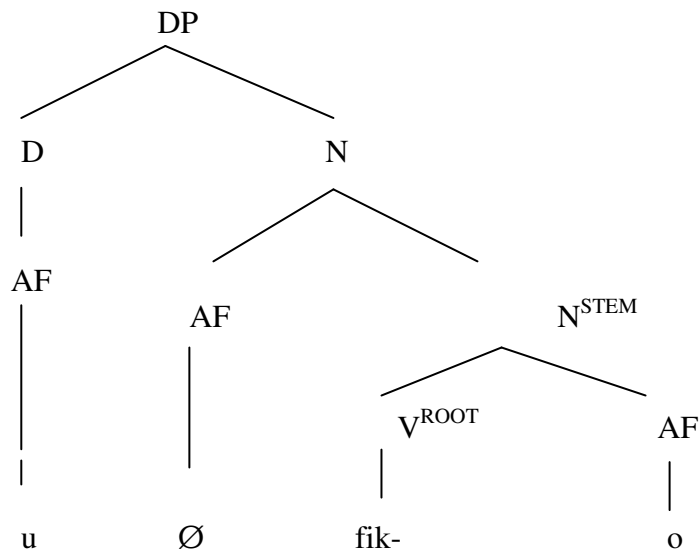
Class 11Prefix: **u(lu-)**Suffix: **-o****ufiko** (arrival)**Nominalisation in class 11****ufiko** (arrival)

7. Ufiko lomfana lwavuyisa abazali bakhe.
(The arrival of the young man made his parents happy).

ufiko	
ARGSTR	= ARG 1 = e : r D – ARG 1 = X : phys. object) D – ARG 2 = y : location
EVSTR	= D - E 1 = e ₁ : process D - E 2 = e ₂ : state Restr = Temporally ordered Head = e ₂
QUALIA	= FORMAL = fika _ result (e ₁ , x, y) AGENTIVE = -fika _ act _ Event (e ₁ , x)

Hierarchy of semantic concepts

Arrive - Location - Motion - Result - Event

The lexical semantic representation of the deverbative **-ufiko** in (7) above has an explanation similar to that in (4) above. The distinguishing difference relates to the agentive quale, where in (7), the agentive quale is specified for the feature [Event] which is absent in (4).

Class 14

Prefix: **ubu-**

Suffix: **-o**

ubufiko (quality of arrival)

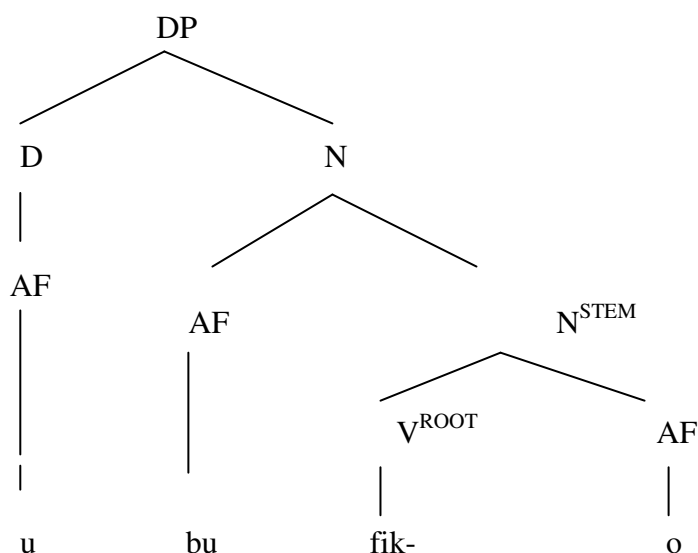

Nominalisation in class 14

ubufiko (quality of arrival)

8. Abantwana bavuyela ubufiko bomzali.
(The children like the quality arrival of the parent).

ufiko	
ARGSTR	= ARG 1 = e : r D – ARG 1 = X : phys. object) D – ARG 2 = y : location
EVSTR	= D - E 1 = e ₁ : process D - E 2 = e ₂ : state Restr = Temporally ordered Head = e ₂
QUALIA	= FORMAL = fika _ result (e ₁ , x, y) AGENTIVE = -fika _ act_ Quality (e ₁ , x)

Hierarchy of semantic concepts

Arrive - Location - Motion - Result - Quality

The lexical semantic representation of **-ubufiko** in (8) above has an explanation similar to that in (7) above. The distinguishing difference relates to the agentive quale, where in (8), the agentive quale is specified for the feature [Quality] which is absent in (7).

In recapitulation, the lexical semantic representation of nominalisations from motion verbs with locative argument can be captured as shown below:

A. The motion verbs where the locative refers to a location take an animate argument, the event is a process, and one formal quale occurs in terms of which the animate argument is in a process (of arriving) (e₁, x).

B. Nominalisation in class 1

The analysis reflects the analysis of the verb **fika** in (1) above, except that the argument is only human, hence the semantic concept refers to this feature, that is [human]. The presence of the prefix **um-** and the suffix **-i** compositionally realise an interpretation of human for **umfiki**.

B. Nominalisation in class 3

The deverbative **umfiko** in class 3 in (2) above refers to the way of arriving. The argument is reflected in the formal quale (x) to refer to the manner of arrival. In addition the feature [Manner] appears in the agentive quale.

C. Nominalisation in class 7

The class 7 deverbative with the suffix **-i** denotes the feature human. The analysis of class 7 deverbative is similar to that of class 1 nominalisation the only difference relates to the agentive quale which displays the feature [Intensive] introduced by the prefix **isi-** in class 7.

D. Nominalisation in class 9

The class 9 deverbative **imfiki** can be compared with the analysis in (3) above. The only difference pertains to the fact the class 9 deverbative is specified for the feature [expert] introduced by the prefix **im-** in class 9. The deverbative noun **imfiki** refers to an individual level nominal which is defined to a particular event.

E. Nominalisation in class 11

The deverbative **ufiko** in class 11 can be analysed in a similar way to class 3 above. The only difference relates to the agentive quale which exhibits the feature [Event] introduced by the prefix **u(lu-)** in class 11. The deverbative noun **ufiko** refers to a stage level nominal which is defined to a particular event.

F. Nominalisation in class 14

The argument **ubufiko** in class 14 can be analysed in a similar way to class 11 above. The only difference relates to the agentive quale which exhibits the feature [Quality] introduced by the prefix **ubu-** in class 14, which is absent in class 11. The examples of deverbatives derived from intransitive motion verbs with a locative argument demonstrate that most deverbatives are prevalent in class 1, class 3, class 11, class 14,

and to a lesser extent class 7 and class 9 respectively. The deverbatives that are derived from class 1, class 7 and class 9 denote [human] where the nominal suffix is **-i**. In class 5, where the nominal suffix is **-a** the deverbative noun **ingena** denotes a person (who enters). This class 5 deverbative can be analysed in a similar way to the class 1 deverbative.

The derogatory notion that is normally attributed to deverbatives in class 5 does not apply in the case of **ingena** (a person who enters). Most deverbatives in class 14 denote a feature [Quality].

In summary, the examples of deverbatives derived from intransitive motion verbs with locative argument demonstrate that these deverbatives are most prevalent in class 1 and class 14 as is shown in the lexical schematic representation in sub-section 4.2.5 of chapter 4. In class 1 these deverbatives denote count nouns where the nominal suffix is **-i**. There is only one deverbative in class 9 **ingena** where the nominal suffix is **-a**, and this deverbative denotes human. There is a group of deverbatives in class 3, class 9, and class 11 with the nominal suffix **-o**, denoting manner of event.

There is only one deverbative in class 6 **amangeno** with the nominal suffix **-o**, denoting artifact. There is group of deverbatives in class 14 with the nominal suffix **-i** or **-o**, denoting quality. Only one deverbative in class 7 **isihlalo** with the nominal suffix **-o**, denoting artifact. The deverbatives denoting humans where the nominal suffix is **-i** can readily be associated with corresponding plural nouns, however, the deverbatives in class 9 which have other semantic features do not readily take a corresponding plural form, as can be shown with the irregular deverbatives ***iintlalo** and ***iimo**, respectively. It is evident that the set of lexical semantic representations of the range of nominals derived from the intransitive motion verbs with a locative argument in sub-section 4.2.6 of chapter 4 can be analysed in terms of a similar lexical semantic representations presented in sub-section 5.2.6 of chapter 5 as is demonstrated in the analysis of the motion verb **fika** in sub-section 5.2.6 above.

5.2.6.2 The locative refers to source

The various deverbatives derived from the intransitive motion verb **phuma** where the locative refers to source demonstrate a semantic type such as Person, Event, Manner of event

Action/Result, Cognition and Quality as specified in sub-section 5.2.6 of chapter 5. The motion verbs as explained in sub-section 4.2.6 of chapter 4 display the lexical schematic representation below which demonstrates various deverbatives from the following noun classes 1, 3, 5,7, 9, 11 and 14.

Nominalisation from – **phuma** (go out, exit)

The verb **phuma** (go out, exit)

1. Umntwana uphumile endlwini.
(The child exited from the house).

-phuma	
ARGSTR	= ARG 1 = x : phys(ical) object D – ARG 1 = y : location
EVSTR	= E 1 = e ₁ : process E 2 = e ₂ : state Restr(ucturing) = Temporally ordered Head = e ₂
QUALIA	= FORMAL = from (e ₂ , x, y) AGENTIVE = -phuma _ act (e ₁ , x)

Hierarchy of semantic concepts

Exit - Location - Motion

The lexical semantic representation of **-phuma** above displays two arguments in its argument structure (AGRSTR). One argument is the physical object that performs (or undergoes) the act of exiting / going out and the other argument is a default argument representing the location from which the act of exiting / going out takes place. The event structure (EVSTR) displays two events of which the state event (e₂) is the head. The qualia features display the formal quale, which specifies the state of arrival of a physical object at a location, and the agentive quale, which specifies the act (process) of exiting / going out of the physical object (e.g. individual).

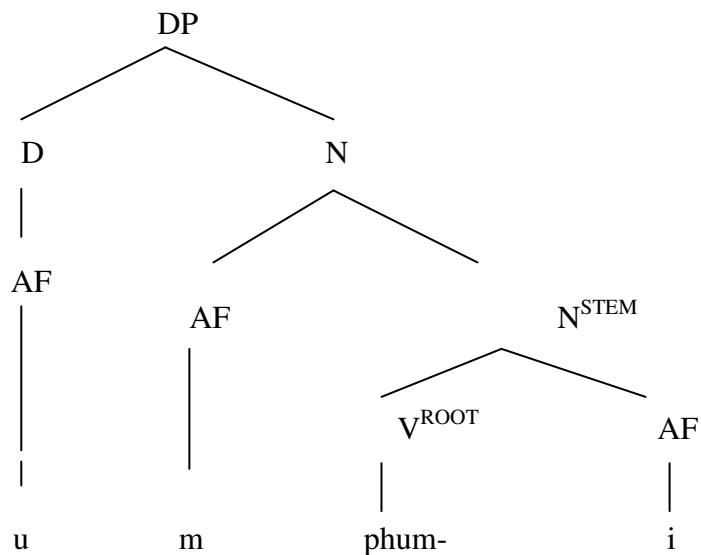
Class 1Prefix: **um-**Suffix: **-i****umphumi** (person who goes out)**Nominalisation in class 1****umphumi** (person who goes out)

2. Umphumi uhambile.
(The person who goes out has left).

-umphumi	
ARGSTR	= ARG 1 = x : phys(ical) object D – ARG 1 = y : location
EVSTR	= E 1 = e ₁ : process E 2 = e ₂ : state Restr = Temporally ordered Head = e ₂
QUALIA	= FORMAL = from (e ₂ , x, y) AGENTIVE = -phuma _ act (e ₁ , x)

Hierarchy of semantic concepts

Go out - Location - Motion - Human

The lexical semantic representation of the deverbative **umphumi** displays an argument structure containing two arguments. The one argument represents the person who goes out, and the other argument, a default argument, represents the location where the going out takes place. The event structure exemplifies two default events, namely the process of going out, and the resulting state. These events are temporally ordered and the state event (e_2) occurs as the head of the event structure. The qualia structure displays the formal quale, which represents the state of going out of a human at a location. The agentive quale specifies the act (i.e process) of going out by an individual.

Class 5

Prefix: **iphuma-**

Suffix: **-a**

iphuma (a person who always goes out)

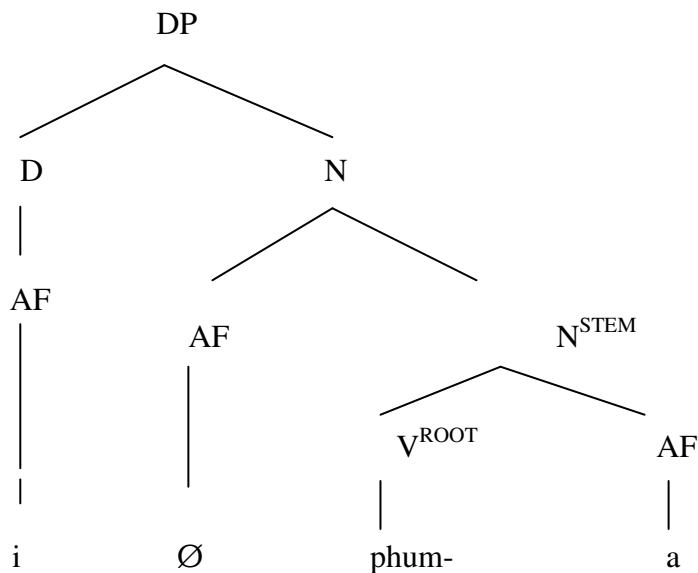

3. Iphuma lidiniwe.
(The person who habitually goes out is tired).

iphuma	
ARGSTR	= ARG 1 = x : phys(ical) object D – ARG 1 = y : location
EVSTR	= E 1 = e ₁ : process E 2 = e ₂ : state Restr = Temporally ordered Head = e ₂
QUALIA	= FORMAL = from (e ₂ , x, y)
	AGENTIVE = -phuma _ act_ derogatory (e ₁ , x)

Hierarchy of semantic concepts

Go out - Location - Motion - Human [derogatory]

The explanation of the lexical semantic representation of the deverbative noun **iphuma** is similar to that of **umphumi** in (2) above. The distinguishing difference relates to the formal quale which exhibits the feature [derogatory] in (3), which is absent in (2).

Class 3

Prefix: **um-**

Suffix: **-o**

umphumo (arrival)

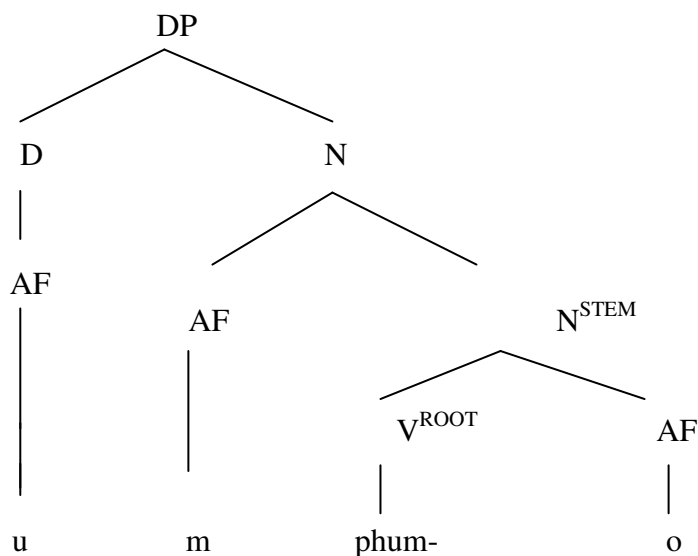

Nominalisation in class 3: Act / Event**umphumo** (act of coming out)

4. Umphumo wamajoni enkampini ulibazisekile.
(The coming out of soldiers from the camp has been delayed).

umphumo	
ARGSTR	= ARG 1 = e : r D – ARG 1 = X : physical object D – ARG 2 = y : location
EVSTR	= D - E 1 = e ₁ : process D - E 2 = e ₂ : state Restr = Temporally ordered Head = e ₂
QUALIA	= FORMAL = (e _r , x, y) AGENTIVE = -phuma _ at (e ₁ , x)

Hierarchy of semantic concepts

Coming out - Location - Motion - Event

The lexical semantic representation of the deverbative **-umphumo** in (4) above, displays three arguments in its argument structure. Two of these arguments are default arguments. These are the physical object that comes out and the location from which the coming out occurs. The other argument is the reference (r) of the event of coming out by itself. The event structure (EVSTR) displays two default events, namely the process of coming out and the resulting state. These events are temporally ordered and is headed by the state (e₂) event. The formal role in the qualia structure represents the act of coming out.

Nominalisation in class 3: Manner**umphumo** (Manner of coming out)

5. Abafazi bavuyela umphumo wabantwana babo.
(The women rejoiced the way of coming out of their children).

umphumo	
ARGSTR	= ARG 1 = e : r D – ARG 1 = X : physical object D – ARG 2 = y : location
EVSTR	= D - E 1 = e ₁ : process D - E 2 = e ₂ : state Restr = Temporally ordered Head = e ₂
QUALIA	= FORMAL = (e _r , x, y) AGENTIVE = -phuma _ Manner (e ₁ , x)

Hierarchy of semantic concepts

Coming out - Manner - Location - Motion - Event

The lexical semantic representation of **umphumo** (manner of arriving) has an explanation similar to that in (4) above. The distinguishing difference relates to the agentive quale, where in (5), the agentive quale is specified for the feature [Manner], which is absent in (4).

Class 11

Prefix: **u(lu-)**

Suffix: **-o**

umphumo (coming out)

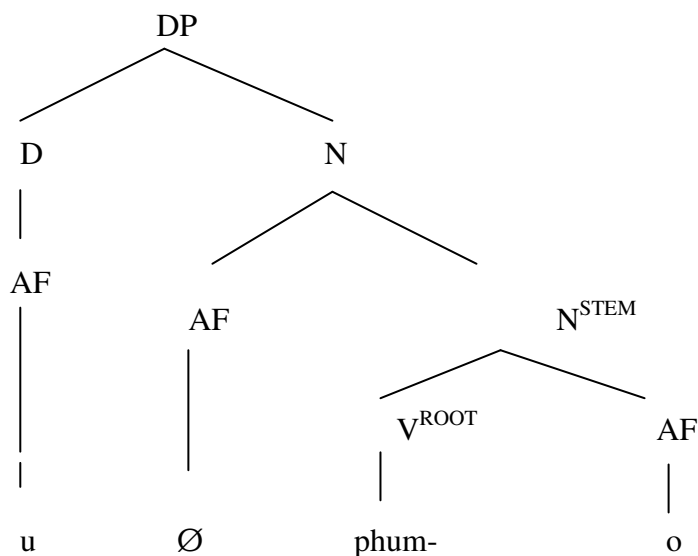

Nominalisation in class 11

uphumo (coming out)

6. Uphumo entolongweni lwavuyisa ibanjwa.
(The coming out from jail made the prisoner happy).

uphumo	
ARGSTR	= ARG 1 = e : r D – ARG 1 = X : phys. object) D – ARG 2 = y : location
EVSTR	= D - E 1 = e ₁ : process D - E 2 = e ₂ : state Restr = Temporally ordered Head = e ₂
QUALIA	= FORMAL = phuma _ result (e ₁ , x, y) AGENTIVE = -phuma _ act _ Event (e ₁ , x)

Hierarchy of semantic concepts

Coming out - Location - Motion - Result - Event

The lexical semantic representation of the deverbative **-uphumo** in (6) above has an explanation similar to that in (4) above. The distinguishing difference relates to the agentive quale, where in (6), the agentive quale is specified for the feature [Event] which is absent in (4).

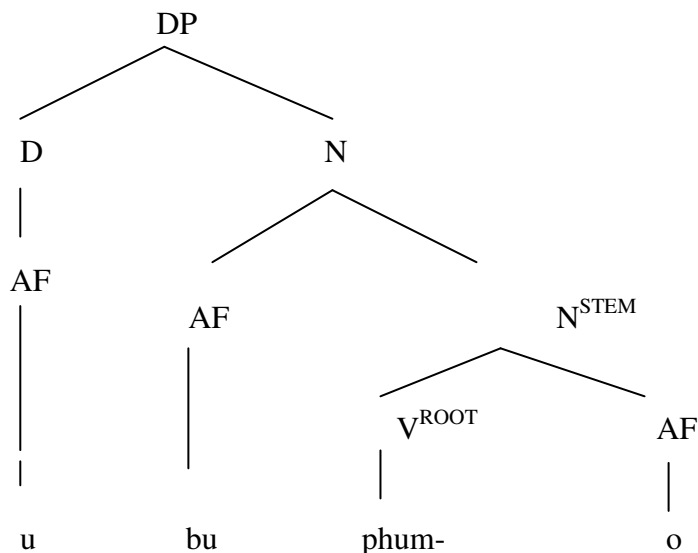
Class 14Prefix: **ubu-**Suffix: **-o****ubuphumo** (quality of coming out)**Nominalisation in class 14****ubuphumo** (quality of coming out)

7. Ubuphumo benja esangweni boyikisa abantwana.
(The quality coming out of the dog from the gate made the children afraid).

ubuphumo

ARGSTR = ARG 1 = e : r

D – ARG 1 = X : phys. object)

D – ARG 2 = y : location

EVSTR = D - E 1 = e₁ : processD - E 2 = e₂ : state

Restr = Temporally ordered

Head = e₂QUALIA = FORMAL = **phuma**_ result (e₁, x, y)AGENTIVE = **-phuma**_ act_ Quality (e₁, x)

Hierarchy of semantic concepts

Coming out - Location - Motion - Result - Quality

The lexical semantic representation of **-ubuphumo** in (7) above has an explanation similar to that in (6) above. The distinguishing difference relates to the agentive quale, where in (7), the agentive quale is specified for the feature [Quality] which is absent

Observation regarding the analysis of motion verbs where the locative refers a source:

The lexical semantic representation of nominalisations from motion verbs where the locative argument refers to a source can be illustrated as shown below:

A. The motion verbs where the locative refers to a source can take an animate argument, the event is a process, and one formal quale occurs in terms of which the animate argument is in a process (of exiting) (e_1, x).

B. Nominalisation in class 1

The analysis reflects the analysis of the verb **phuma** in (1) above, except that the argument is only human, hence the semantic concept refers to this feature, that is [human]. The presence of the prefix **um-** and the suffix **-i** compositionally realise an interpretation of human for **umphumi**.

C. Nominalisation in class 3

The argument **umphumo** in class 3 in (4) above refers to the way of going out. The argument is reflected in the formal quale (x) to refer to the manner of going out. In addition the feature [Manner] appears in the agentive quale.

D. Nominalisation in class 7

The class 7 deverbative with the suffix **-i** denotes the feature human. The analysis of class 7 deverbative is similar to that of class 1 nominalisation the only difference relates to the agentive quale which displays the feature [Intensive] introduced by the prefix **isi-** in class 7.

E. **Nominalisation in class 11**

The argument **ufiko** in class 11 can be analysed in a similar way to class 3 above. The only difference relates to the agentive quale which exhibits the feature [Event] introduced by the prefix **u(lu-)** in class 11. The deverbative noun **uphumo** refers to a stage level nominal which is defined to a particular event.

F. **Nominalisation in class 14**

The argument **ubuphumo** in class 14 can be analysed in a similar way to class 11 above. The only difference relates to the agentive quale which exhibits the feature [Qualityt] introduced by the prefix **ubu-** in class 11, which is absent in class 11.

G. The examples of deverbatives derived from intransitive motion verbs where the locative argument refers to a source demonstrate that most deverbatives are prevalent in almost all the noun classes with the exception of class 5, where only the deverbative noun **iphuma** denoting a person (who fequently goes out) occurs. This class 5 deverbative can be analysed in a similar way to the class 1 deverbative the only difference pertains to the fact that **iphuma** has the feature derogatory in its agentive quale.

Most deverbative nouns derived from class 7 denote a (habitual) person where the nominal suffix is **-i**, however, where the nominal suffix is **-o**, a result interpretation is exhibited, as can be illustrated in the lexical semantic representation of **isiphumo** (outcome) below:

isiphumo	
ARGSTR	= ARG 1 = e : r D – ARG 1 = X : phys. object) D – ARG 2 = y : location
EVSTR	= D - E 1 = e ₁ : process D - E 2 = e ₂ : state Restr = Temporally ordered Head = e ₂
QUALIA	= FORMAL = (e _r , x, y) AGENTIVE = -phuma_ Result (e ₁ , x)

The deverbative nouns in class 9 denote an expert person where the nominal suffix is **-i**, but in circumstances where the nominal suffix is **-o**, an [Action] interpretation obtains. Most deverbatives in class 11 denote a feature [Event] whereas class 14 deverbatives denote a feature [Quality].

In summary, the examples of deverbatives derived from intransitive motion verbs with locative referring to a source demonstrate that these deverbatives are mostly prevalent in class 1 and class 11. The deverbatives in class 1 have a nominal suffix **-i** and they denote count nouns. The deverbatives in class 9 denote count nouns where the nominal suffix is **-i**. There is only one deverbative in class 5 **iphuma** denoting human with the nominal suffix is **-a**. Most of the deverbatives in class 3 denote manner of event where the nominal suffix is **-o**.

In class 14 the all the deverbatives from the group of intransitive motion verbs with locative referring to a source denote quality with the nominal suffix **-o** except for the deverbative **ububhaci** which has a nominal suffix **-i**. The deverbatives denoting humans where the nominal suffix is **-i** can readily be associated with corresponding plural nouns, however, the deverbatives in class 9 which have other semantic features do not readily take a corresponding plural form, as can be shown with an uncharacteristic deverbative **iimbuyo**. It is evident that the set of lexical semantic representations of the range of nominals derived from the intransitive motion verbs with a locative argument in sub-section 4.26 of chapter 4 can be analysed in terms of a similar lexical semantic representations presented in sub-section 5.2.6 of chapter 5 as is demonstrated in the analysis of the motion verb **phuma** in sub-section 5.2.6 above.

5.2.6.3 Motion verbs location refers to direction

The various deverbatives derived from the intransitive motion verb **nyuka** where the locative refers to direction demonstrate a semantic type such as Person, Event, Manner of event Action/Result, Cognition and Quality as specified in sub-section 5.2.6 of chapter 5. The motion verbs as explained in sub-section 4.2.6 of chapter 4 display the lexical schematic representation below which demonstrates various deverbatives from the following noun classes 1, 3, 5, 7, 9, 11 and 14.

Nominalisation from – nyuka (go up, climb)

The verb **nyuka** (go up, climb)

1. Indoda inyuke intaba.
(The man climbed up the mountain).

-nyuka	
ARGSTR	= ARG 1 = x : phys(ical) object
	D – ARG 1 = y : location
EVSTR	= E 1 = e_1 : process
	E 2 = e_2 : state
	Restr(ucturing) = Temporally ordered
	Head = e_2
QUALIA	= FORMAL = up (e_2 , x , y)
	AGENTIVE = -nyuka _ act (e_1 , x)

Hierarchy of semantic concepts

Climb - Location - Motion

The lexical semantic representation of the motion verb **-nyuka** above displays two arguments in its argument structure (ARGSTR). One argument is the physical object that performs act of climbing and the other argument is a default argument representing the location from which the act of climbing takes place. The event structure displays two events of which the state event (e_2) is the head. The qualia features display the formal quale, which specifies the state of climbing of a physical object at a location, and the agentive quale, which specifies the act (process) of climbing of the physical object(e.g. individual).

Class 1

Prefix: **um-**

Suffix: **-i**

umnyuki (person who goes up)

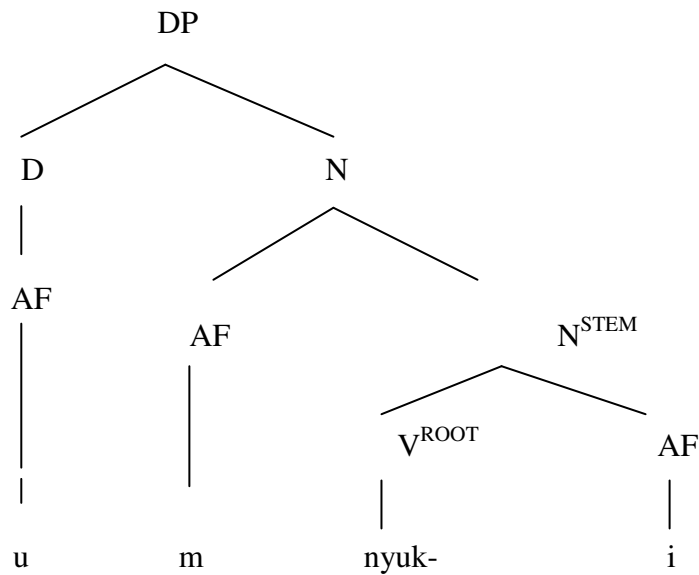

Nominalisation in class 1

umnyuki (person who goes up)

2. Umnyuki uphumlile.
(The going up person is resting).

-umnyuki	
ARGSTR	= ARG 1 = x : phys(ical) object D – ARG 1 = y : location
EVSTR	= E 1 = e ₁ : process E 2 = e ₂ : state Restr = Temporally ordered Head = e ₂
QUALIA	= FORMAL = to (e ₂ , x, y) AGENTIVE = -nyuka _ act (e ₁ , x)

Hierarchy of semantic concepts

Go up - Location - Motion - Human

The lexical semantic representation of the deverbative **umnyuki** displays an argument structure (ARGSTR) containing two arguments. The one argument represents the person who goes up, and the other argument, a default argument, represents the location where the going takes place. The event structure (EVSTR) exemplifies two default events, namely the

process of going up, and the resulting state. These events are temporally ordered and the state event (e_2) occurs as the head of the event structure. The qualia structure displays the formal quale, which represents the state of going up of a human at a location. The agentive quale specifies the act (i.e process) of going up by an individual.

Class 3

Prefix: **um-**

Suffix: **-o**

umnyuko (climbing up)

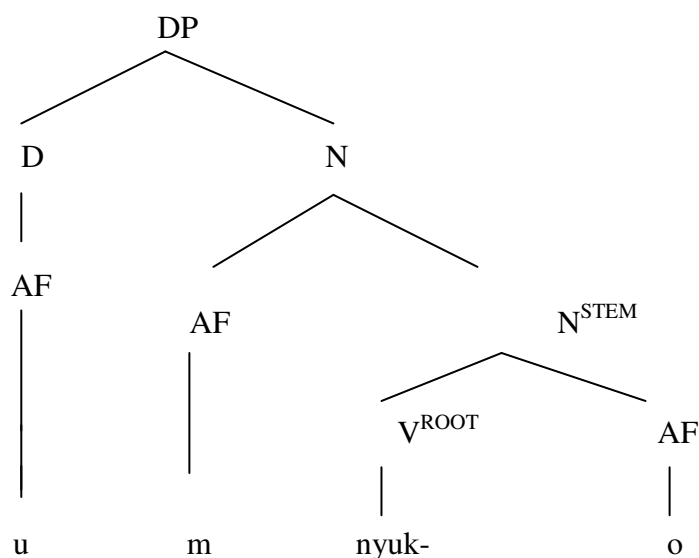

Nominalisation in class 3: Act / Event

umnyuko (act of climbing up)

3. Umnyuko wentaba urhoxisiwe.
(The climbing up of the mountain has been postponed).

umnyuko	
ARGSTR	= ARG 1 = e : r D – ARG 1 = X : phys. object) D – ARG 2 = y : location
EVSTR	= D - E 1 = e ₁ : process D - E 2 = e ₂ : state Restr = Temporally ordered Head = e ₂
QUALIA	= FORMAL = (e _r , x, y) AGENTIVE = -nyuka _ at (e ₁ , x) _

Hierarchy of semantic concepts

Climb up - Location - Motion - Event

The lexical semantic representation of the deverbative **-umnyuko** in (3) above, displays three arguments in its argument structure (ARGSTR). Two of these arguments are default arguments. These are the physical object that climbs up and the location from which the climbing up occurs. The other argument is the reference (r) of the event of climbing up by itself. The event structure (EVSTR) displays two default events, namely the process of climbing up and the resulting state. These events are temporally ordered and is headed by the state (e₂) event. The formal role in the qualia structure represents the act of climbing up.

Nominalisation in class 3: Manner

umnyuko (Manner of climbing)

4. Abafana balungiselela umnyuko wentaba.
(The young men prepared for the climbing of the mountaing).

umnyuko	
ARGSTR	= ARG 1 = e : r D – ARG 1 = X : phys. object) D – ARG 2 = y : location
EVSTR	= D - E 1 = e ₁ : process D - E 2 = e ₂ : state Restr = Temporally ordered Head = e ₂
QUALIA	= FORMAL = (e _r , x, y) AGENTIVE = -nyuka _ Manner (e ₁ , x)

Hierarchy of semantic concepts

Climbing - Manner - Location - Motion - Event

The lexical semantic representation of **umnyuko** (manner of climbing) has an explanation similar to that in (3) above. The distinguishing difference relates to the agentive quale, where in (4), the agentive quale is specified for the feature [Manner], which is absent in (3).

Class 11

Prefix: **u(lu-)**

Suffix: **-o**

unyuko (climbing up)

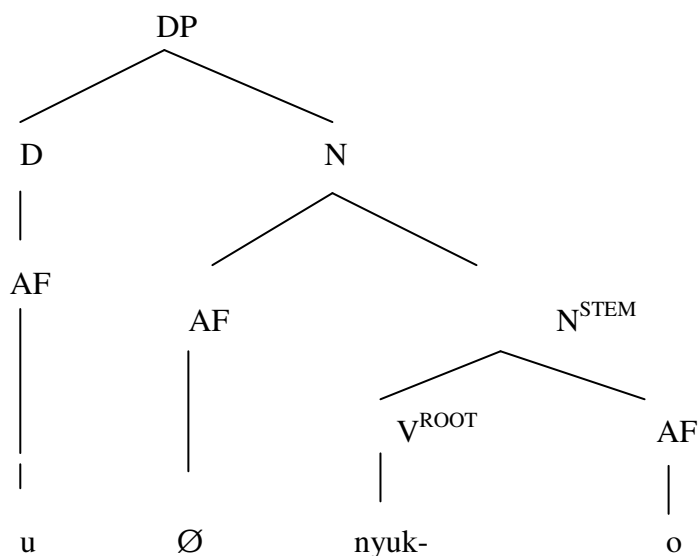

Nominalisation in class 11

unyuko (climbing up)

5. Unyuko lweqhina lwadinisa abadlali.
(The climbing of the hill made the players tired).

unyuko	
ARGSTR	= ARG 1 = e : r D – ARG 1 = X : phys. object) D – ARG 2 = y : location
EVSTR	= D - E 1 = e ₁ : process D - E 2 = e ₂ : state Restr = Temporally ordered Head = e ₂
QUALIA	= FORMAL = nyuka _ result (e ₁ , x, y) AGENTIVE = -nyuka _ act _ Event (e ₁ , x)

Hierarchy of semantic concepts

Climbing up - Location - Motion - Result - Event

The lexical semantic representation of the deverbative **-unyuko** in (5) above has an explanation similar to that in (3) above. The distinguishing difference relates to the agentive quale, where in (6), the agentive quale is specified for the feature [Event] which is absent in (3).

Class 9

Prefix: **in**

Suffix: **-o**

inyuko (arrival)

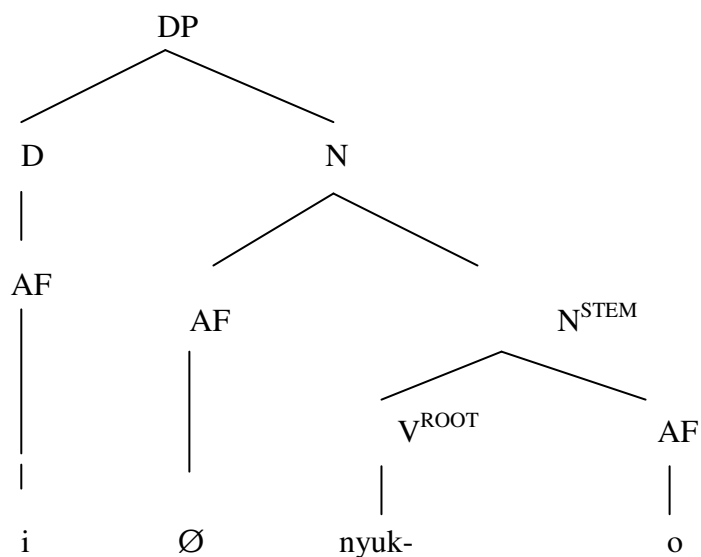

Nominalisation in class 9

inyuko (act of climbing up)

6. Inyuko yentaba yadinisa amakwenkwe.
 (The act of climbing the mountain made the boys tired).

inyuko	
ARGSTR	= ARG 1 = e : r D – ARG 1 = X : phys. object) D – ARG 2 = y : location
EVSTR	= D - E 1 = e ₁ : process D - E 2 = e ₂ : state Restr = Temporally ordered Head = e ₂
QUALIA	= FORMAL = nyuka _ result (e ₁ , x, y) AGENTIVE = -nyuka _ act (e ₁ , x)

Hierarchy of semantic concepts

Climb up - Location - Motion - Result

The lexical semantic representation of **-inyuko** in (6) above has an explanation similar to that in (4) above. The distinguishing difference relates to the formal quale, whereas the formal quale in (6) specifies the result of the event, the formal quale in (4) represents the event only.

Class 14

Prefix: **ubu-**

Suffix: **-o**

ubunyuko (quality of climbing)

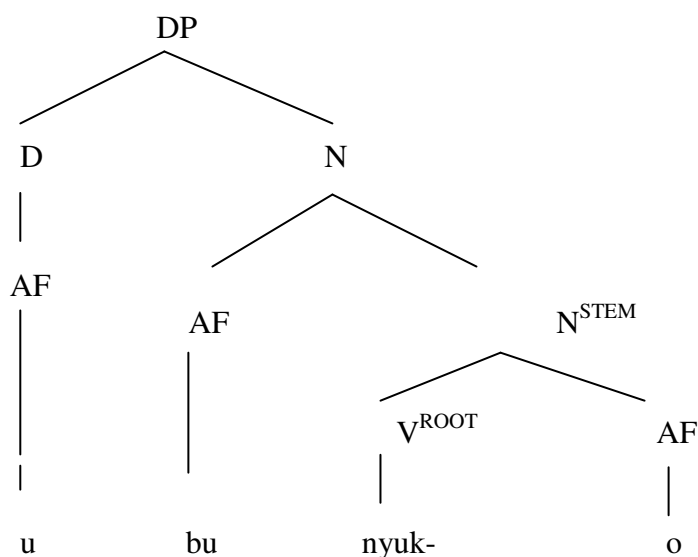

Nominalisation in class 14

ubunyuko (quality of climbing)

7. Ubunyuko bentaba baphazanyiswa yimvula.
(The quality climbing of the mountain was delayed by rain)

ubunyuko	
ARGSTR	= ARG 1 = e : r D – ARG 1 = X : phys. object) D – ARG 2 = y : location
EVSTR	= D - E 1 = e ₁ : process D - E 2 = e ₂ : state Restr = Temporally ordered Head = e ₂
QUALIA	= FORMAL = nyuka _ result (e ₁ , x, y) AGENTIVE = -nyuka _ Quality (e ₁ , x)

Hierarchy of semantic concepts

Climbing - Location - Motion - Result - Quality

The lexical semantic representation of **-ubunyuko** in (7) above has an explanation similar to that in (6) above. The distinguishing difference relates to the agentive quale, where in (7), the agentive quale is specified for the feature [Quality] which is absent in (6).

Observation regarding the analysis of motion verbs where the locative refers to direction:

The above analysis of deverbatives derived from the motion verb **-nyuka** where the locative argument refers to direction can be illustrated as follows:

- A. The motion verbs where the locative refers to direction can take an animate argument, the event is a process, and one formal quale occurs in terms of which the animate argument is in a process (of climbing) (e₁, x).

B. Nominalisation in class 1

The analysis reflects the analysis of the verb **nyuka** in (1) above, except that the argument is only human, hence the semantic concept refers to this feature, that is [human]. The presence of the prefix **um-** and the suffix **-i** compositionally realise an interpretation of human for **umnyuki**.

C. Nominalisation in class 3

The argument **umnyuko** in class 3 in (4) above refers to the way of climbing. The argument is reflected in the formal quale (x) to refer to the manner of climbing. In addition the feature [Manner] appears in the agentive quale.

D. Nominalisation in class 7

The class 7 deverbative with the suffix **-i** denotes the feature human. The analysis of class 7 deverbative is similar to that of class 1 nominalisation the only difference relates to the agentive quale which displays the feature [Intensive] introduced by the prefix **isi-** in class 7, which is absent in class 1.

E. Nominalisation in class 11

The argument **unyuko** in class 11 can be analysed in a similar way to class 3 above. The only difference relates to the agentive quale which exhibits the feature [Event] introduced by the prefix **u(lu-)** in class 11. The deverbative noun **unyuko** refers to a stage level nominal which is defined to a particular event.

F. Nominalisation in class 14

The argument **ubunyuko** in class 14 can be analysed in a similar way to class 11 above. The only difference relates to the agentive quale which exhibits the feature [Quality] introduced by the prefix **ubu-** in class 14, which is absent in class 11.

- G. The examples of deverbatives derived from intransitive motion verbs where the locative argument refers to direction demonstrate that only the verb **nyuka** (climb) can at least have all the noun class variations. The other deverbatives derived from this group can only denote a human for class 1 and class 7 respectively.

In summary, there seems to be some regularity on the prevalence of deverbatives derived from class 1 in intransitive motion where the locative refers to direction. The deverbatives in class 1 and 7 denote count nouns where the nominal suffix is **-i**. There is only one deverbative in class 7, **isinyuko**, denoting instrument with the nominal suffix **-o**. In class 3 only one deverbative **umnyuko** with the nominal suffix **-o**, denoting manner of event can be derived. Only one deverbative **inyuko** with the nominal suffix **-o**, denoting action can be derived in class 9.

In class 11 only one deverbative **unyuko** with the nominal suffix **-o**, denoting result can be derived. Only one deverbative derived from from class 14, **ubunyuko**, has the nominal suffix **-o** denoting quality 14. The deverbatives denoting humans where the nominal suffix is **-i** can readily be associated with corresponding plural nouns, however, the deverbatives in class 9 which have other semantic features do not readily take a corresponding plural form, as can be shown with the uncharacteristic deverbative ***iinyuko**.

It is evident that the set of lexical semantic representations of the range of nominals derived from the intransitive motion verbs with a locative referring to a source in sub-section 4.2.6 of chapter 4 can be analysed in terms of a similar lexical semantic representations presented in sub-section 5.2.6 of chapter 5 as is demonstrated in the analysis of the motion verb **nyuka** in sub-section 5.2.6 above.

5.3 TRANSITIVE VERBS

5.3.1 Verbs of change of state

Levin (1993) described these verb classes in sub-section 4.3.1 of chapter 4. In section 4.2 sub-section 4.2.3 the transitive verbs of change of state were analysed in terms of their deverbatives in noun classes 1, 3, 5, 7, 9, 11 and 14. In the following section 5.3 sub-section 5.3.1 the deverbatives from the verb **goba** are examined in terms of their use. The various

deverbatives derived from the transitive verbs of change of state **goba** demonstrate a semantic type such as Person, Event/ Manner of event, Action/Result, Instrument and Quality as specified in sub-section 5.3.1 of chapter 5.

Nominalisation from – **goba** (bend)

The verb **goba** (bend)

1. Inkwenkwe igobe imela.
(The boy bent the knife).

-goba	
ARGSTR	= ARG 1 = x : animate ARG 2 = y : phys(ical) object)
EVSTR	= E 1 = e ₁ : process E 2 = e ₂ : state Restr(ucturing) = Temporally ordered Head = e ₂
QUALIA	= FORMAL = goba _ result (e ₂ , y) AGENTIVE = -goba _ act (e ₁ , x, y)

Hierarchy of semantic concepts

Bend - Location - Motion

The lexical semantic representation of the transitive verb of change of state **-goba** can be explained as displaying two arguments in its argument structure (AGRSTR). One argument denotes the entity (individual) performing the bending, and the other argument represents the physical object from which the act of bending takes place. The event structure (EVSTR) displays two events of which the state event (e₂) is the head. The qualia features display the formal quale, which specifies the state of bending of a physical object, and the agentive quale, which specifies the act (process) of bending of the physical object.

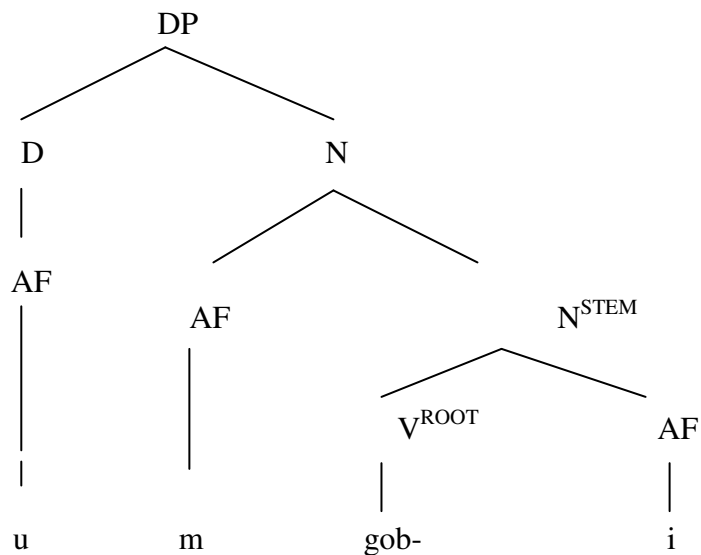
Class 1Prefix: **um-**Suffix: **-i****umgobi** (person who bends (something))**Nominalisation in class 1****umgobi** (person who bends something))

2. Umgobi wemela usike inyama.
(The person who bends the knife cut the meat).

umgobi	
ARGSTR	= ARG 1 = x : human D - ARG 1 = y : phys. object)
EVSTR	= D - E 1 = e ₁ : process D - E 2 = e ₂ : state Restr = Temporally ordered Head = e ₂
QUALIA	= FORMAL = goba _result (e _r , x, y) AGENTIVE = -goba _act (e ₁ , x)

Hierarchy of semantic concepts

Bend - Process - Actor - Human

The lexical semantic representation of the deverbative **–umgobi** in (2) above displays that in its argument structure it has two arguments; the one argument is the human who bends something, and the other argument is the default srgument (i.e. the physical object). The presence of the prefix **um** and the suffix **–i** compositionally realise an interpretation of human for **umgobi**. The event structure displays two default events, namely the process of bending and the resulting state. These events are temporally ordered and is headed by the state (e_2) event. The formal role in the qualia structure represents the act of bending.

Class 7

Prefix: **isi-**

Suffix: **-i**

isigobi (person who bends (something))

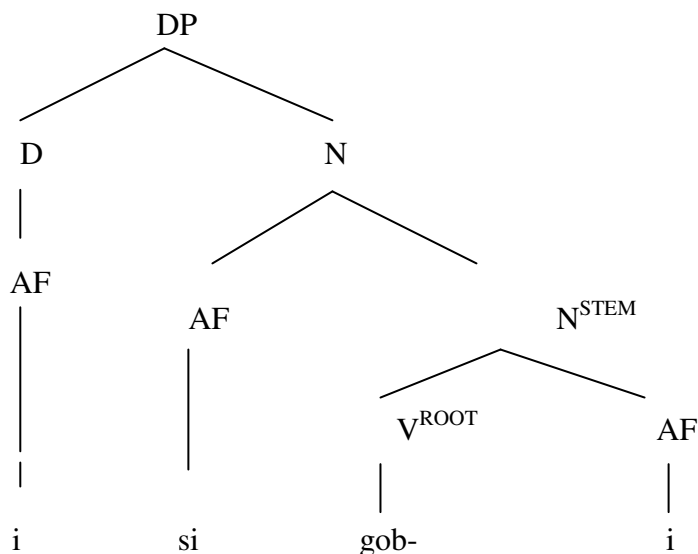

Nominalisation in class 7

isigobi (person who bends (frequently))

3. Isigobi sendoda saphule ucango.
(The frequently bending person broke the door).

isigobi	
ARGSTR	= ARG 1 = x : human D – ARG 1 = y : phys. object)
EVSTR	= D - E 1 = e ₁ : process D - E 2 = e ₂ : state Restr = Temporally ordered Head = e ₂
QUALIA	= FORMAL = goba _result (e _r , x, y) AGENTIVE = -goba _act_ intensity (e ₁ , x)

Hierarchy of semantic concepts

Bend - Intensive - Actor – Human

The lexical semantic representation of the deverbative noun **isigobi** in (3) above, can be explained in a similar way to the representation of **umgobi** in (2) above. The only difference relates to the agentive quale which in addition has the feature [intensive] to the notion of bending. The event structure displays two default events, namely the process of bending and the resulting state. These events are temporally ordered and is headed by the state (e₂) event. The formal role in the qualia structure represents the act of bending. The deverbative noun **isigobi** can appear as a head in a NP taking a descriptive possessive realized as a cognate noun as is illustrated in (3) above.

Class 9

Prefix: **in-**

Suffix: **-i**

ingobi (an expert person who bends (something))

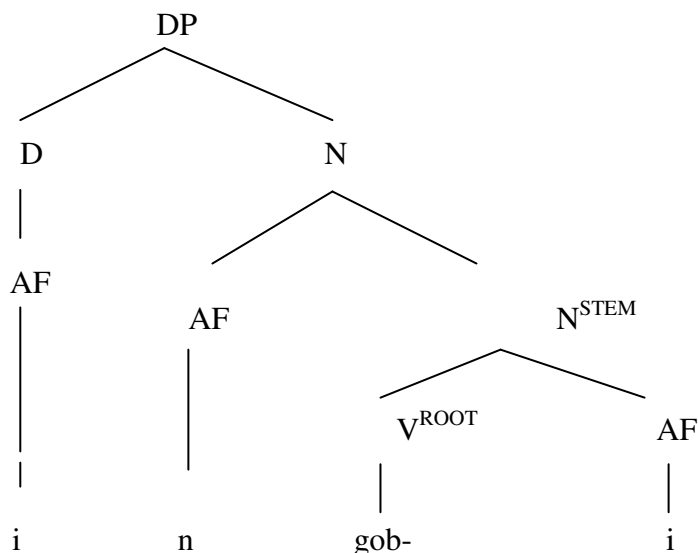

Nominalisation in class 9

ingobi (person who bends (something))

4. Ingobi yathunga ilokwe.
(The expert bending person sew a dress).

ingobi	
ARGSTR	= ARG 1 = x : human D - ARG 1 = y : phys. object)
EVSTR	= D - E 1 = e ₁ : process D - E 2 = e ₂ : state Restr = Temporally ordered Head = e ₂
QUALIA	= FORMAL = goba _result (e _r , x, y) AGENTIVE = -goba _act_expert (e ₁ , x)

Hierarchy of semantic concepts

Bend - Intensive - Actor – Human

The lexical semantic representation of **ingobi** in (4) above, can be explained in a similar way to the representation of **isigobi** in (3) above. The only difference relates to the agentive quale which in addition has the feature [expert] to the notion of bending. The event structure displays two default events, namely the process of bending and the resulting state. These

events are temporally ordered and is headed by the state (e_2) event. The formal role in the qualia structure represents the act of bending.

Class 3

Prefix: **um-**

Suffix: **-o**

umgobo (turn up / over))

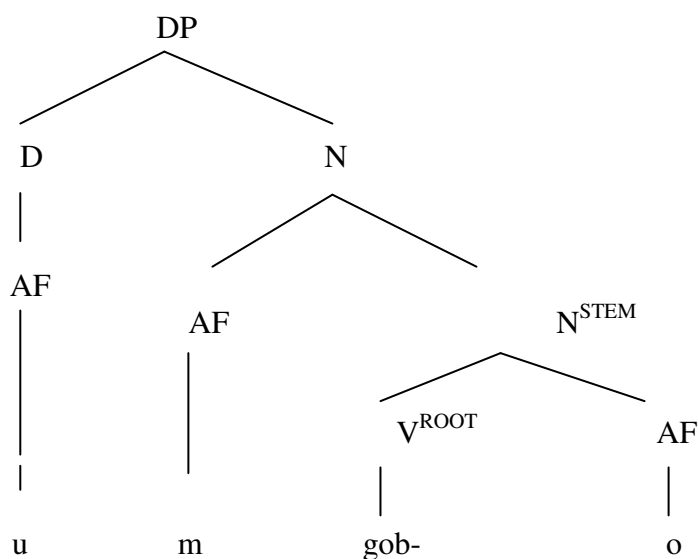

Nominalisation in class 3

umgobo (turn up)

5. Umfazi wenza umgobo welokhwe.

(The woman made a turn up of a dress).

umgobo

ARGSTR = ARG 1 = x : human

D – ARG 1 = X : phys. object)

EVSTR = D - E 1 = e_1 : process

D - E 2 = e_2 : state

Restr = Temporally ordered

Head = e_2

QUALIA = FORMAL = (e_r , x , y)

AGENTIVE = **-goba** _ act [Result] (e_1 , x)

Hierarchy of semantic concepts

Turn - Process - Act

The lexical semantic representation of the deverbative **-umgobo** above displays two arguments in its argument structure; the one argument represents the person who is doing the turn up, and the other argument, a default argument, represents the physical object undergoing the turning up. The event structure displays two default events, namely the process of turning up and the resulting state. These events are temporally ordered and is headed by the state (e_2) event. The formal role in the qualia structure represents the act of turning.

Class 11

Prefix: **u(lu-)**

Suffix: **-o**

ugobo (bending, turning)

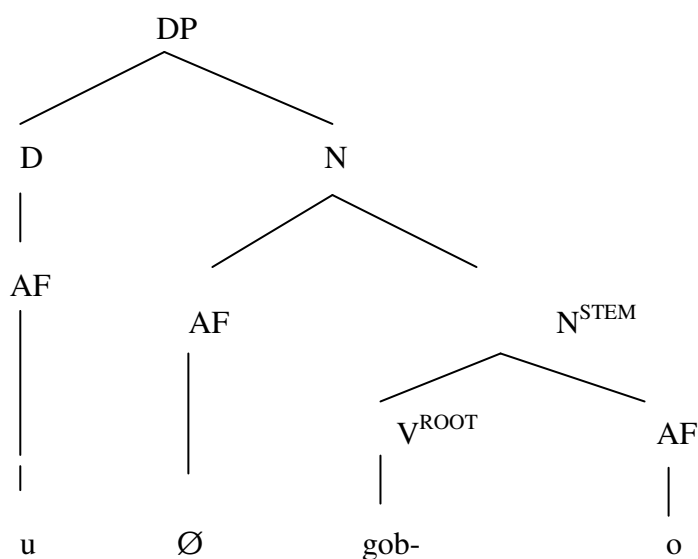

Nominalisation in class 11

ugobo (bending, turning)

6. Ugobo Iwangelwa bubushushu belanga.
(The bending was caused by the heat of the sun).

ugobo	
ARGSTR	= ARG 1 = e : r D – ARG 1 = X : phys. object)
EVSTR	= D - E 1 = e ₁ : process D - E 2 = e ₂ : state Restr = Temporally ordered Head = e ₂
QUALIA	= FORMAL = goba _ result (e ₁ , x, y) AGENTIVE = -goba _ act _ Event (e ₁ , x)

Hierarchy of semantic concepts

Bend - Result - Event

The lexical semantic representation of the deverbative **-ugobo** in (6) above displays two arguments in its argument structure; the one argument represents the reference (r) of the event of bending by itself. The other argument, a default argument, represents the physical object undergoing the bending. The event structure displays two default events, namely the process of bending and the resulting state. These events are temporally ordered and is headed by the state (e₂) event. The formal role in the qualia structure represents the act of bending.

Class 14

Prefix: **ubu**

Suffix: **-o**

ubugobo (quality of bend / turn)

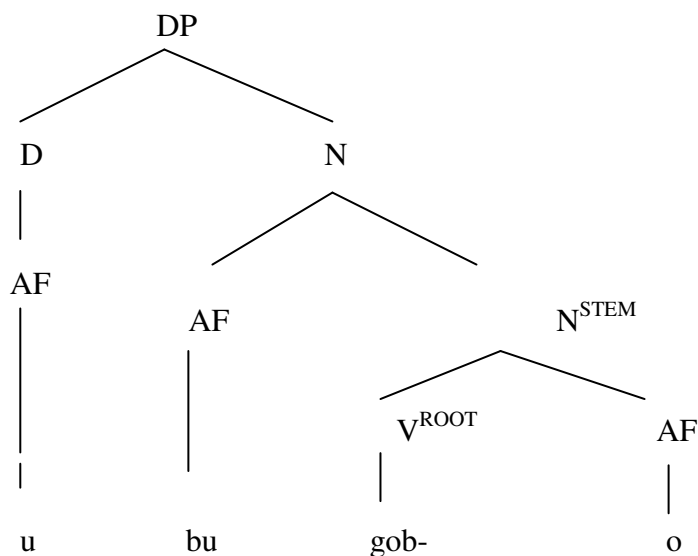

Nominalisation in class 14

ubugobo (quality turn up)

7. Umfazi wenze ubugobo belokwe.

(The woman made a quality turn up of the dress).

ubugobo	
ARGSTR	= ARG 1 = e : r D - ARG 1 = X : phys. object)
EVSTR	= D - E 1 = e ₁ : process D - E 2 = e ₂ : state Restr = Temporally ordered Head = e ₂
QUALIA	= FORMAL = goba _ result (e ₁ , x, y) AGENTIVE = -goba _ act _ Quality (e ₁ , x)

Hierarchy of semantic concepts

Turn up - Result - Quality

The lexical semantic representation of **-ubugobo** in (7) above has an explanation similar to that in (6) above. The distinguishing difference relates to the formal quale, whereas the formal quale in (6) specifies the result of the event, the formal quale in (7) has the feature [Quality] which is absent in (6).

Observation regarding the analysis of transitive verbs of change:

The above analysis of deverbatives derived from the transitive verb of change **-goba** can be illustrated as shown below:

- A. Transitive verbs of change take an animate argument, the event is process and one formal quale occurs in terms of which the animate argument is in a process (of bending) (e₁, x).

B. Nominalisation in class 1

The analysis reflects the analysis of the transitive verb of change **goba** in (2) above, except that the argument is only human, hence the semantic concepts refers to this feature, that is, [Human]. The presence of the prefix **um** and the suffix **-i** compositionally realise an interpretation of human for **umgobi**.

C. Nominalisation in class 7

The class 7 deverbative noun **isigobi** with the suffix **-i** denotes the feature human. The analysis of class 7 **isigobi** in (3) above, is similar to that of class 1 nominalisation in (2). The only difference relates to the agentive quale which displays the feature [intensive] introduced by the prefix **isi-** in class 7.

D. Nominalisation in class 9

The class 9 deverbative **ingobi** in (4) above can be analysed in a similar way to class 7, the only difference relates to the agentive quale which displays the feature [expert] introduced by the prefix **-in** in class 9.

E. Nominalisation in class 3

The argument **umgobo** in class 3 in (5) above, refers to the process of turning up. The argument is shown in the formal quale (x) to refer to the act of turning up. In addition the feature [Result] appears in the agentive quale.

F. Nominalisation in class 11

The argument **ugobo** in class 11 can be analysed in a similar way to (3) above. The only difference relates to the agentive quale which demonstrates the feature [Event] introduced by the prefix **u(lu-)**. In class 11 the deverbative noun **ugobo**, refers to an individual level nominal which is defined to a particular event.

G. Nominalisation in class 14

The argument **ubugobo** in class 14 can be analysed in a similar way to class 11 in (6) above. The only difference relates to the agentive quale which exhibits the feature

[Quality] introduced by the prefix **ubu**. In class 14 the deverbative noun **ubugobo** refers to the individual level nominal which is defined to a particular event.

The other deverbatives derived from transitive verbs of change can be analysed in a similar manner. The only exception in respect of deverbatives derived from transitive verbs of change relates to the class 5 deverbative noun **iphula**, which displays a distinct feature [Derogatory] introduced by the prefix **i(li-)** and the suffix **-a** in its agentive quale.

In summary, the examples of deverbatives derived from transitive verbs of change of state demonstrate that these deverbatives are mostly prevalent in class 1 and class 7 and to a lesser degree in class 11 and class 14 as is demonstrated in the lexical schematic representation in sub-section 4.3.1 of chapter 4. The deverbatives in class 1 have a nominal suffix **-i** and they denote count nouns. There is only one deverbative in class 5, **iphula**, which denotes count nouns but has a nominal suffix **-a**. There are only two deverbatives in class 9, **ingobi** and **imvuli**, with the nominal suffix **-i**, and they denote count nouns. The deverbative **imvalo** in class 9 has a nominal suffix **-o** and denotes action.

The deverbatives in class 14 have a nominal suffix **-o** and they denote quality. In class 7 the deverbatives (*isivuli* and *isivalo*) have a nominal suffix **-i** or **-o** and they denote instrument. The deverbatives denoting humans where the nominal suffix is **-i** can readily be associated with corresponding plural nouns, however, the deverbatives in class 9 which have other semantic features do not readily take a corresponding plural form, as can be shown with the uncharacteristic deverbative ***imvuli**. It is evident that the set of lexical semantic representations of the range of nominals derived from the transitive verbs of change of state in sub-section 4.3.1 of chapter 4 can be analysed in terms of a similar lexical semantic representations presented in sub-section 5.3.1 of chapter 5 as is demonstrated in the analysis of the verbs of change of state **goba** in sub-section 5.3.1 above.

5.3.2 Verbs of creation

Levin (1993) described the verbs of creation classes in sub-section 4.3.2 of chapter 4. In section 4.3 sub-section 4.3.2 the transitive verbs of creation were analysed in terms of their deverbatives in noun classes 1, 3, 5, 7, 9, 11 and 14. In the following section 5.3 sub-section 5.3.1 the deverbatives from the verb **cula** are examined in terms of their use. The various

deverbatives derived from the transitive verbs of creation **cula** demonstrate a semantic type such as Person, Event/ Manner of event, Action/Result, Instrument and Quality as specified in sub-section 5.3.2 of chapter 5.

Nominalisation from – cula (sing)

The verb **cula** (sing)

1. Intombi icula iculo.
(The girl is singing a song)

-cula	
ARGSTR	= ARG 1 = x : human D - ARG 1 = inanimate
EVSTR	= E 1 = e ₁ : process E 2 = e ₂ : state Restr(ucturing) = Temporally ordered Head = e ₂
QUALIA	= FORMAL = cula _ result (e ₂ , y) AGENTIVE = -cula _ act (e ₁ , x, y)

Hierarchy of semantic concepts

Take away - Act

The lexical semantic representation of **cula** can be explained as displaying two arguments in its argument structure. One argument denotes the entity (individual) performing the singing and the other arguments is a default argument. The events are temporally ordered and is headed by the state (e₂) event. The formal role in the qualia structure represents the act of singing.

Class 1

Prefix: **um-**

Suffix: **-i**

umculi (person who sings)

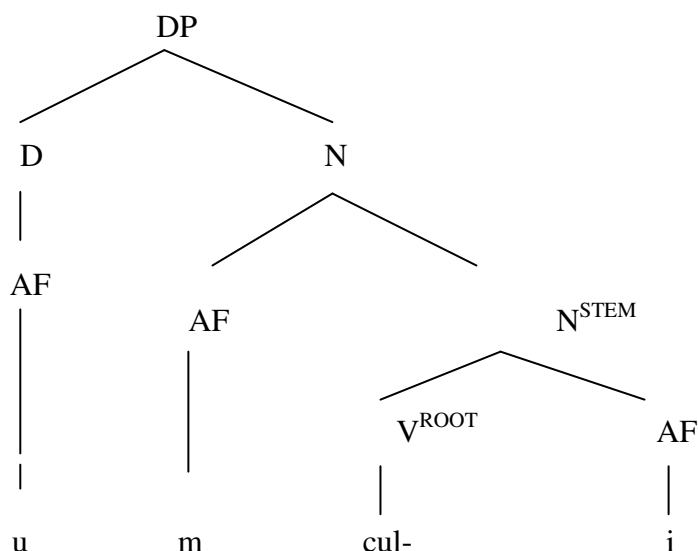

Nominalisation in class 1

umculi (person who sings / singer)

2. Umculi uculile ingoma.
(The singer sang a song).

-umculi	
ARGSTR	= ARG 1 = x : human D - ARG 1 = y : inanimate
EVSTR	= E 1 = e ₁ : process E 2 = e ₂ : state Restr(ucturing) = Temporally ordered Head = e ₂
QUALIA	= FORMAL = cula _ result (e ₂ , y) AGENTIVE = -cula _ act (e ₁ , x, y)

Hierarchy of semantic concepts

Sing - Process - Actor - Human

The lexical semantic representation of the deverbative noun **-umculi** in (2) above displays that in its argument structure it has two arguments; the one argument is the human who sings, and the other argument is the default argument (i.e. the inanimate). The presence of the prefix **um** and the suffix **-i** compositionally realise an interpretation of human for **umculi**. The event structure displays two default events, namely the process of singing and the resulting state.

These events are temporally ordered and is headed by the state (e_2) event. The formal role in the qualia structure represents the act of singing.

Class 5

Prefix: **i(li-)**

Suffix: **-a**

icula (person who sings expertly / singer)

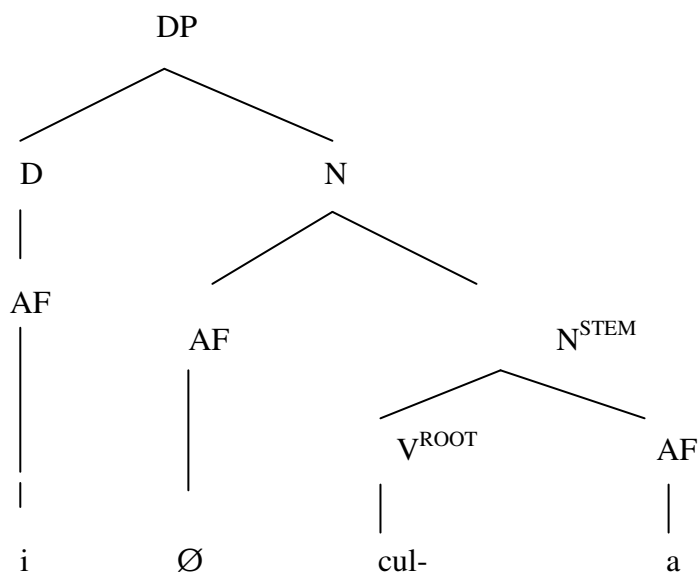

Nominalisation in class 5

icula (person who sings / singer)

3. Icula licule imini yonke.
(The expert singer sang the whole day).

-icula

ARGSTR = ARG 1 = x : human

D - ARG 1 = y : inanimate

EVSTR = E 1 = e_1 : process

E 2 = e_2 : state

Restr(ucturing) = Temporally ordered

Head = e_2

QUALIA = FORMAL = **cula**_result (e_2 , y)

AGENTIVE = **-cula**_act [expert] (e_1 , x , y)

Hierarchy of semantic concepts

Sing - Process - Actor - Human

The explanation of the lexical semantic representation of the deverbative noun **icula** is similar to that of **umculi** in (2) above. The distinguishing difference relates to the formal quale which exhibits the feature [expert] in (3), which is absent in (2).

Class 7

Prefix: **isi-**

Suffix: **-i**

isiculi (person who frequently sings)

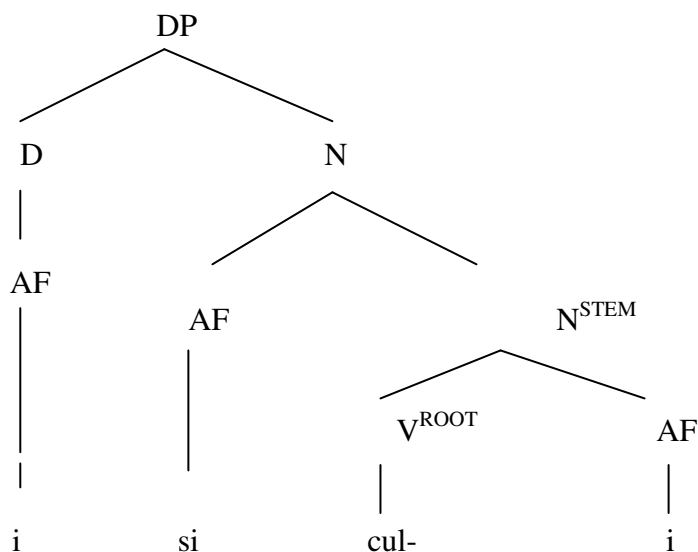

Nominalisation in class 7

isiculi (person who frequently sings / singer)

4. Isiculi sacula Umhobe weSizwe.
(The frequent singer sang the National Anthem).

isiculi

ARGSTR = ARG 1 = x : human

D - ARG 1 = y: animate

EVSTR = D - E 1 = e₁ : process

D - E 2 = e₂ : state

Restr = Temporally ordered

Head = e₂

QUALIA = FORMAL = **cula**_result (e_r, x, y)

AGENTIVE = **-cula**_act_intensity (e₁, x)

Hierarchy of semantic concepts

Sing - Intensive - Actor – Human

The lexical semantic representation of the deverbative noun **isiculi** in (4) above, can be explained in a similar way to the representation of **umculi** in (2) above. The only difference relates to the agentive quale which in addition has the feature [intensive] to the notion of singing. The event structure displays two default events, namely the process of taking away and the resulting state. These events are temporally ordered and is headed by the state (e_2) event. The formal role in the qualia structure represents the act of singing. The deverbative noun **isiculi** can appear as a head in a NP taking a descriptive possessive realized as a cognate noun .

Class 9

Prefix: **in-**

Suffix: **-i**

inkculi (expert singer)

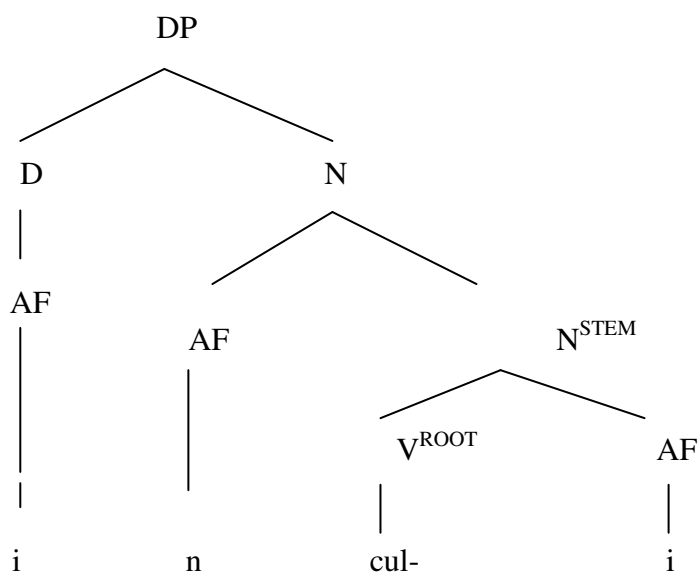

Nominalisation in class 9

inkculi (expert singer)

5. Inkculi yonwabise abantu.
(The expert singer entertained the people).

inkculi	
ARGSTR	= ARG 1 = x : human D - ARG 1 = y: animate
EVSTR	= D - E 1 = e ₁ : process D - E 2 = e ₂ : state Restr = Temporally ordered Head = e ₂
QUALIA	= FORMAL = cula _result (e _r , x, y) AGENTIVE = -cula _act_expert (e ₁ , x)

Hierarchy of semantic concepts

Sing - Expert - Actor – Human

The lexical semantic representation of the deverbative noun **inkculi** in (5) above, can be explained in a similar way to the representation of **umculi** in (2) above. The only difference relates to the agentive quale which in addition has the feature [expert] to the notion of singing

Class 3

Prefix: **um-**

Suffix: **-o**

umculo (singing, way of singing snatching)

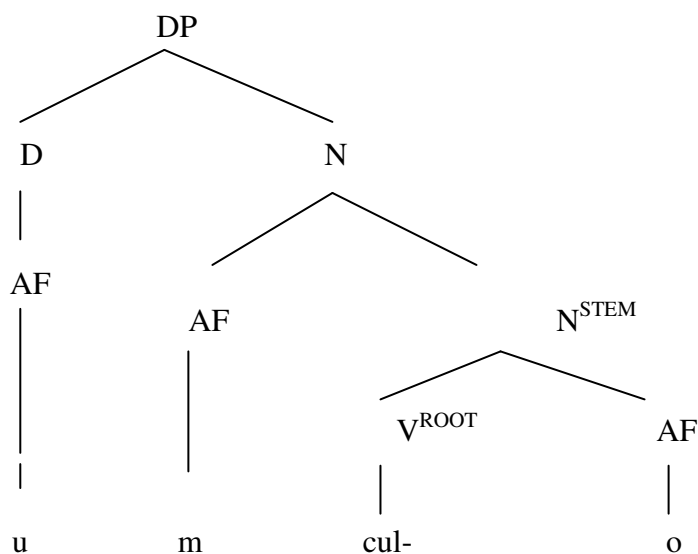

Nominalisation in class 3

umculo (singing, way of singing)

6. Umculo wavakala ubusuku bonke.
(The singing was audible the whole night).

umculo	
ARGSTR	= ARG 1 = e : r D - ARG 1 = inanimate
EVSTR	= D - E 1 = e ₁ : process D - E 2 = e ₂ : state Restr = Temporally ordered Head = e ₂
QUALIA	= FORMAL = (e _r , x, y) AGENTIVE = -cula _ act [Manner] (e ₁ , x)

Hierarchy of semantic concepts

Sing - Process - Act - Manner

The lexical semantic representation of the deverbative **-umculo** in (6) above displays two arguments in its argument structure; one of which is a default argument (i.e. the inanimate argument). The first argument ARG 1, displays the reference (r) of the event of singing by itself. The event structure displays two default events, namely the process of singing up and the resulting state. These events are temporally ordered and is headed by the state (e₂) event. The formal role in the qualia structure represents the act of singing.

Class 5

Prefix: **i(li-)**

Suffix: **-o**

iculo (a song)

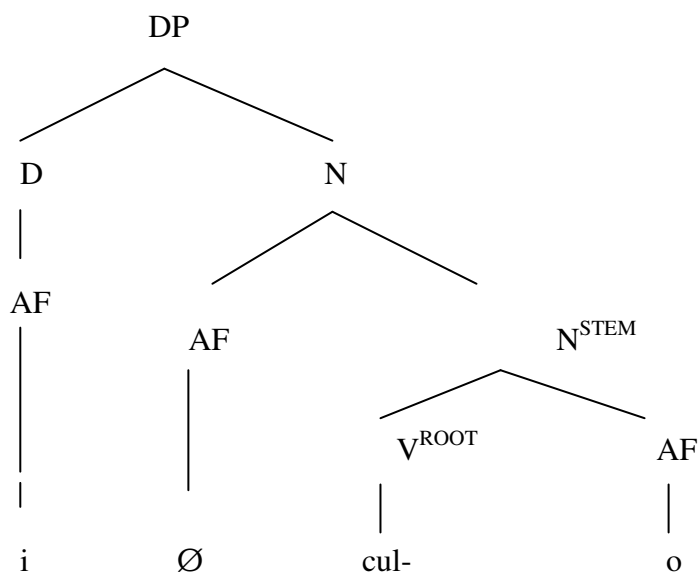

Nominalisation in class 5

iculo (a song)

7. Umfazi wacula iculo.
(The woman sang a song).

iculo	
ARGSTR	= ARG 1 = e : r D - ARG 1 = animate
EVSTR	= D - E 1 = e ₁ : process D - E 2 = e ₂ : state Restr = Temporally ordered Head = e ₂
QUALIA	= FORMAL = (e _r , x, y) AGENTIVE = -cula _ act_ [Result] (e ₁ , x)

The explanation of the lexical semantic representation of the deverbative noun **iculo** in (7) above is similar to that of **umculo** in (6) above. The distinguishing difference relates to the formal quale which exhibits the feature [Result] in (7), which is absent in (6).

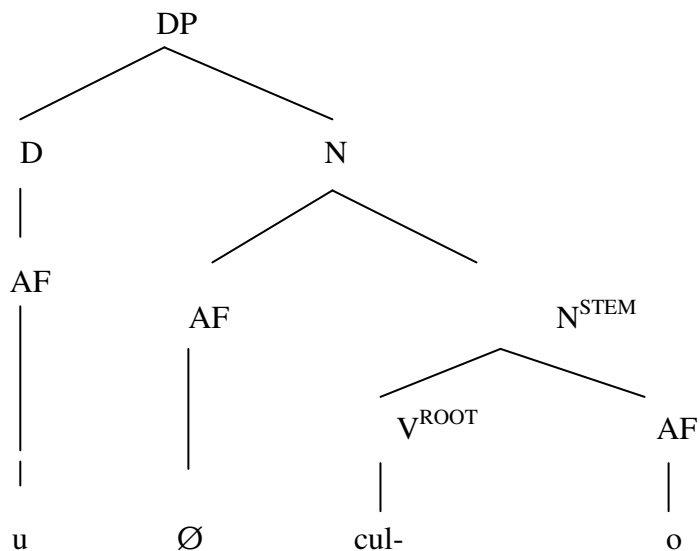
Class 11Prefix: **u(lu-)**Suffix: **-o****uculo** (singing, act of singing)**Nominalisation in class 11****uculo** (singing, act of singing)

8. Uculo lwekayala lwavuyisa abantu.

(The singing of the choir entertained the people).

uculo	
ARGSTR	= ARG 1 = e : r D - ARG 1 = animate
EVSTR	= D - E 1 = e ₁ : process D - E 2 = e ₂ : state Restr = Temporally ordered Head = e ₂
QUALIA	= FORMAL = (e _r , x, y) AGENTIVE = -cula _ act [Action] (e ₁ , x)

Hierarchy of semantic concepts

Sing - Process - Action

The explanation of the lexical semantic representation of the deverbative noun **uculo** in (8) above is similar to that of **umculo** in (7) above. The distinguishing difference relates to the formal quale which exhibits the feature [Action] in (8), which is absent in (7).

Class 14

Prefix: **ubu**

Suffix: **-o**

ubuculo (quality of singing)

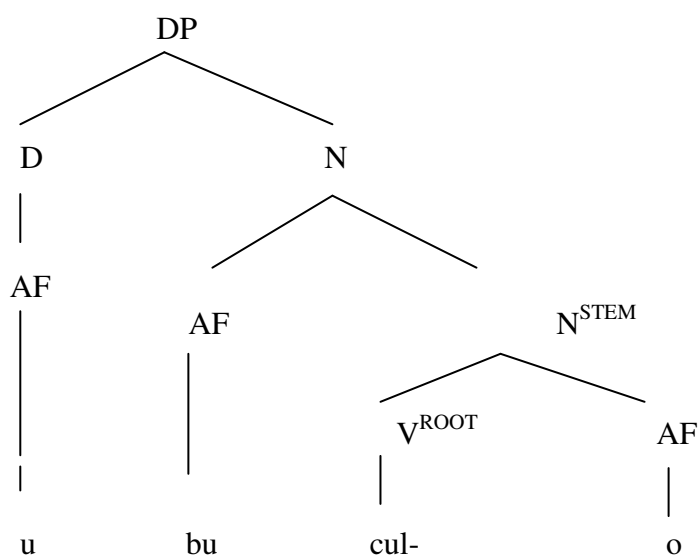

Nominalisation in class 14

ubuculo (quality of singing)

9. Ubuculo bomzali balalisa usana.
(The quality singing of the parent caused the baby to sleep).

ubuculo	
ARGSTR	= ARG 1 = e : r D - ARG 1 = X : phys. object) D - ARG 2 = animate
EVSTR	= D - E 1 = e ₁ : process D - E 2 = e ₂ : state Restr = Temporally ordered Head = e ₂
QUALIA	= FORMAL = cula _ result (e ₁ , x, y) AGENTIVE = -cula _ act _ Quality (e ₁ , x)

Hierarchy of semantic concepts

Sing - Result - Quality

The lexical semantic representation of **-ubuculo** in (9) above has an explanation similar to that in (8) above. The distinguishing difference relates to the formal quale, whereas the formal quale in (8) specifies the result of the event, the formal quale in (9) has the feature [Quality] which is absent in (8).

Observation regarding the analysis of transitive verbs of change of possession:

The above analysis of deverbatives derived from the transitive verb of creation can be illustrated as shown below:

A. Transitive verbs of creation take an animate argument, the event is process and one formal quale occurs in terms of which the animate argument is in a process (of creation) (e₁, x).

B. Nominalisation in class 1

The analysis reflects the analysis of the transitive verb of creation **cula** in (1) above, except that the argument is only human, hence the semantic concepts refers to this feature, that is, [Human]. The presence of the prefix **um** and the suffix **-i** compositionally realise an interpretation of human for **umculi**.

C. **Nominalisation in class 7**

The class 7 deverbative noun **isiculi** with the suffix **-i** denotes the feature human. The analysis of class 7 **isiculi** in (3) above, is similar to that of class 1 nominalisation in (2). The only difference relates to the agentive quale which displays the feature [intensive] introduced by the prefix **isi-** in class 7.

D. **Nominalisation in class 9**

The class 9 deverbative **inkculi** in (5) above can be analysed in a similar way to class 7, the only difference relates to the agentive quale which displays the feature [expert] introduced by the prefix **-in** in class 9.

E. **Nominalisation in class 3**

The argument **umculo** in class 3 in (6) above, refers to the process of singing. The argument is shown in the formal quale (x) to refer to the act of singing. In addition the feature [Manner] appears in the agentive quale.

F. **Nominalisation in class 11**

The argument **uculo** in class 11 can be analysed in a similar way to (6) above. The only difference relates to the agentive quale which demonstrates the feature [Result] introduced by the prefix **u(lu-)**. In class 11 the deverbative noun **uculo**, refers to an individual level nominal which is defined to a particular event.

G. **Nominalisation in class 5**

The argument **icula** in class 5 can be analysed in a similar way to class 1, the only difference relates to the agentive quale which displays the feature [derogatory] introduced by the prefix **-i(li-)** in class 5.

H. **Nominalisation in class 14**

The argument **ubuculo** in class 14 can be analysed in a similar way to class 11 in (8) above. The only difference relates to the agentive quale which exhibits the feature [Quality] introduced by the prefix **ubu**. In class 14 the deverbative noun **ubuculo** refers to the stage level nominal which is defined to a particular event.

The other deverbatives derived from transitive verbs of creation can be derived and analysed in the same manner. These deverbatives are mostly specified for all classes of nouns with the exception of the noun class 5, denoting [derogatory]. Only one deverbative noun **icula**, is derived from the creation verbs.

In summary, the examples of deverbatives derived from transitive verbs of creation demonstrate that these deverbatives are mostly prevalent in class 1, class 7, class 9, and class 14 as is illustrated in sub-section 4.3.2 of chapter 4. The deverbatives in class 1 and class 7 denote count nouns and have a nominal suffix **-i**. There is only one deverbative in class 5, **icula**, which denotes count nouns and has a nominal suffix **-a**. Only one deverbative in class 5, **iculo**, denotes action or result and has the nominal suffix **-o**. The deverbatives in class 9 denote count nouns where the nominal suffix is **-i**.

There is only one deverbative in class 9, **imbaso**, denoting manner of event where the nominal suffix is **-o**. The deverbatives in class 14 denote quality where the nominal suffix is **-i** or **-o**. There is only one deverbative in class 11, **usilo**, denoting action where the nominal suffix is **-o**. The deverbatives denoting humans where the nominal suffix is **-i** can readily be associated with corresponding plural nouns, however, the deverbatives in class 9 which have other semantic features do not readily take a corresponding plural form, as can be shown with the uncharacteristic deverbative ***iimbaso**. It is evident that the set of lexical semantic representations of the range of nominals derived from the transitive verbs of creation in sub-section 4.3.2 of chapter 4 can be analysed in terms of a similar lexical semantic representations presented in sub-section 5.3.2 of chapter 5 as is demonstrated in the analysis of the creation verb **cula** in sub-section 5.3.2 above.

5.3.3 Verbs of perception

Levin (1993) described the verbs of perception classes in sub-section 4.3.3 of chapter 4. In section 4.3 sub-section 4.3.3 the transitive verbs of perception were analysed in terms of their deverbatives in noun classes 1, 3, 7, 9, 11 and 14. In the following section 5.3 sub-section 5.3.3 the deverbatives from the verb **bona** are examined in terms of their use. The various deverbatives derived from the transitive verbs of perception **bona** demonstrate a semantic type such as Person, State, Event/ Manner of event, Action/Result, Artefact and Quality as specified in sub-section 5.3.3 of chapter 5.

Nominalisation from – bona (see)The verb **bona** (see)

1. Indoda ibona inyoka.
(The man sees a snake).

-bona	
ARGSTR	= ARG 1 = x : human D - ARG 1 = animate
EVSTR	= E 1 = e ₁ : process E 2 = e ₂ : state Restr(ucturing) = Temporally ordered Head = e ₂
QUALIA	= FORMAL = bona _ result (e ₂ , y) AGENTIVE = -bona _ act (e ₁ , x, y)

Hierarchy of semantic concepts

See - Process - Act

The lexical semantic representation of **bona** can be explained as displaying two arguments in its argument structure. One argument denotes the entity (individual) seeing (something) and the other arguments is a default argument. The events are temporally ordered and is headed by the state (e₂) event. The formal role in the qualia structure represents the act of seeing.

Class 1Prefix: **um-**Suffix: **-i****umboni** (person who sees)

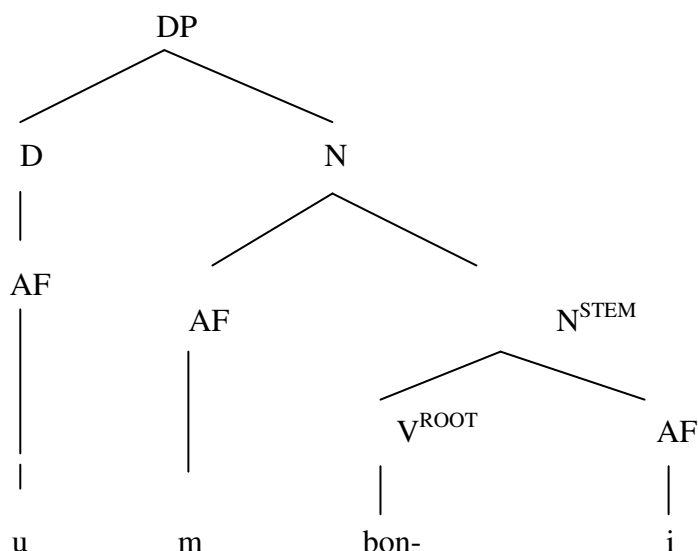

Nominalisation in class 1

umboni (person who sees)

2. Umboni wathenga imoto entle.
(The seeing person bought a beautiful car).

umboni	
ARGSTR	= ARG 1 = x : human D - ARG 1 = y : inanimate
EVSTR	= E 1 = e ₁ : process E 2 = e ₂ : state Restr(ucturing) = Temporally ordered Head = e ₂
QUALIA	= FORMAL = bona _ result (e ₂ , y) AGENTIVE = -bona _ act (e ₁ , x, y)

Hierarchy of semantic concepts

See - Process - Actor - Human

The lexical semantic representation of **-umboni** in (2) above displays that in its argument structure it has two arguments; the one argument is the human who sees (something), and the other argument is the default argument (i.e. the inanimate). The presence of the prefix **um** and the suffix **-i** compositionally realise an interpretation of human for **umboni**. The event structure displays two default events, namely the process of seeing and the resulting state.

These events are temporally ordered and is headed by the state (e_2) event. The formal role in the qualia structure represents the act of seeing.

Class 7

Prefix: **isi-**

Suffix: **-i**

isiboni (person who frequently sees (something))

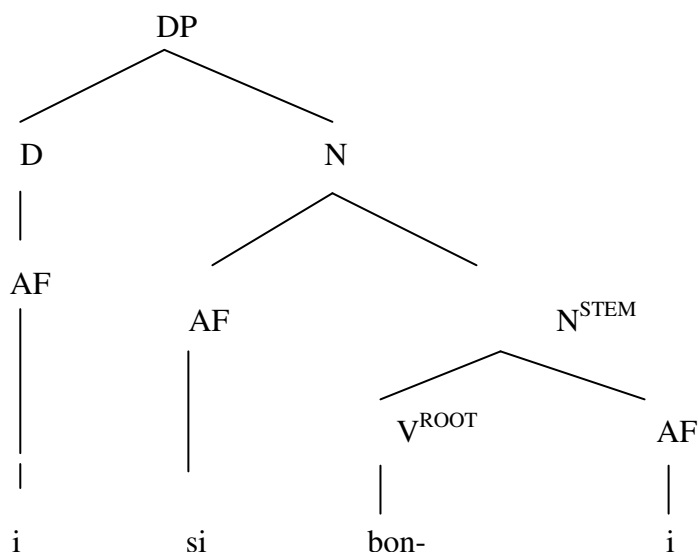

Nominalisation in class 7

isiboni (person who frequently sees (something))

3. Isiboni sabhaqa amasela.
(The frequently seeing person discovered the thieves).

isiboni	
ARGSTR	= ARG 1 = x : human D - ARG 1 = y: animate
EVSTR	= D - E 1 = e_1 : process D - E 2 = e_2 : state Restr = Temporally ordered Head = e_2
QUALIA	= FORMAL = bona_result (e_r , x, y) AGENTIVE = -bona_act_intensity (e_1 , x)

Hierarchy of semantic concepts

See - Intensive - Actor – Human

The lexical semantic representation of the deverbative noun **isiboni** in (4) above, can be explained in a similar way to the representation of **umboni** in (2) above. The only difference relates to the agentive quale which in addition has the feature [intensive] to the notion of seeing. The event structure displays two default events, namely the process of seeing and the resulting state. These events are temporally ordered and is headed by the state (e_2) event. The formal role in the qualia structure represents the act of seeing.

Class 9

Prefix: **im-**

Suffix: **-i**

imboni (a person who is an expert in seeing)

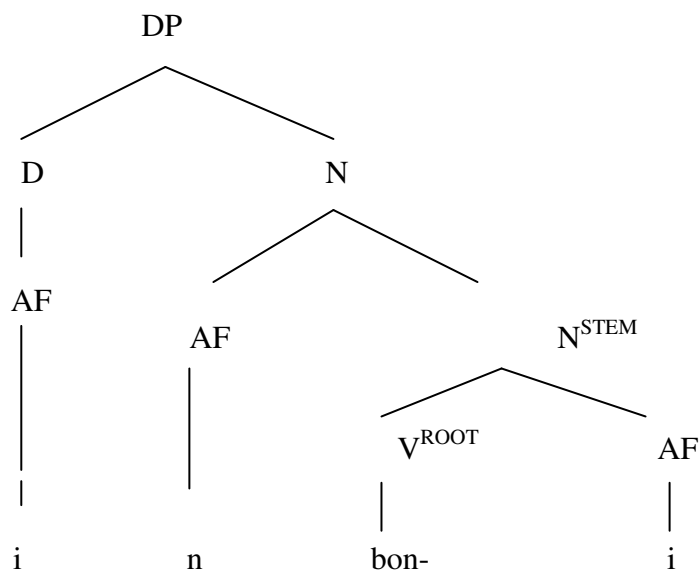

Nominalisation in class 9

imboni (a person who is an expert in seeing)

4. Imboni yalungisa ingxaki yemoto.
(The expert seeing person fixed the problem of the car).

imboni	
ARGSTR	= ARG 1 = x : human D – ARG 1 = y : phys. object
EVSTR	= D - E 1 = e ₁ : process D - E 2 = e ₂ : state Restr = Temporally ordered Head = e ₂
QUALIA	= FORMAL = bona _result (e _r , x, y) AGENTIVE = -bona _act_expert (e ₁ , x)

Hierarchy of semantic concepts

See - Expert - Actor – Human

The lexical semantic representation of the deverbative noun **imboni** in (4) above, can be explained in a similar way to the representation of **umboni** in (2) above. The only difference relates to the agentive quale which in addition has the feature [expert] to the notion of seeing.

Class 3

Prefix: **um-**

Suffix: **-o**

umbono (vision, sight)

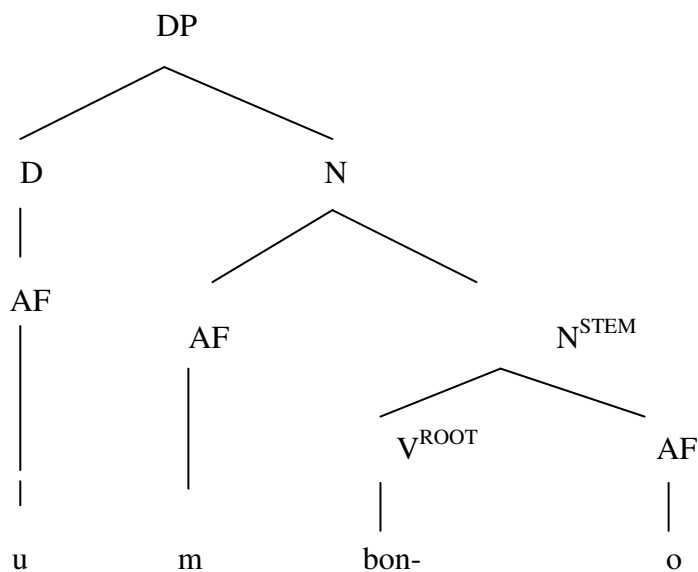

Nominalisation in class 3**umbono** (vision, sight)

5. Umbono weKumkani luxolo.
(The vision of the King is peace).

umbono	
ARGSTR	= ARG 1 = e : r D - ARG 1 = inanimate
EVSTR	= D - E 1 = e ₁ : process D - E 2 = e ₂ : state Restr = Temporally ordered Head = e ₂
QUALIA	= FORMAL = (e _r , x, y) AGENTIVE = -bona _ act [Manner] (e ₁ , x)

Hierarchy of semantic concepts

See - Process - Act - Manner

The lexical semantic representation of the deverbative **-umbono** in (5) above displays two arguments in its argument structure; one of which is a default argument (i.e. the inanimate argument). The first argument ARG 1, displays the reference (r) of the event of visualization by itself. The event structure displays two default events, namely the process of visualization and the resulting state. These events are temporally ordered and is headed by the state (e₂) event. The formal role in the qualia structure represents the act of visualization. The deverbative noun **umbono** can appear as a head in a NP taking a descriptive possessive realized as a cognate noun as is illustrated in (5) .

Class 11Prefix: **u(lu-)**Suffix: **-o****ubono** (seeing, sight)

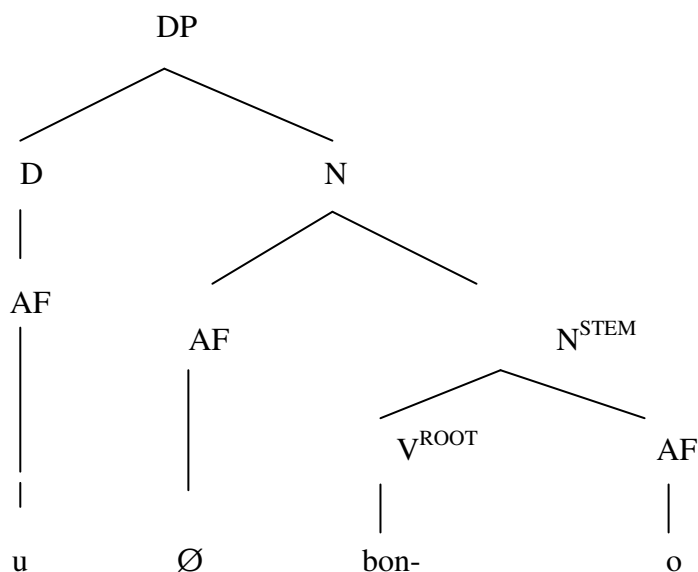

Nominalisation in class 11

ubono (seeing, sight)

6. Ubono lwenyoka loyikise abantwana.
(The sight of the snake frightened the children).

ubono	
ARGSTR	= ARG 1 = e : r D – ARG 1 = animate
EVSTR	= D - E 1 = e ₁ : process D - E 2 = e ₂ : state Restr = Temporally ordered Head = e ₂
QUALIA	= FORMAL = (e _r , x, y) AGENTIVE = -bona _ act [Event] (e ₁ , x)

Hierarchy of semantic concepts

See - Process - Act - Event

The lexical semantic representation of the deverbative **-ubono** in (6) above displays two arguments in its argument structure; one of which is a default argument (i.e. the animate argument). The first argument ARG 1, displays the reference (r) of the event of visualization by itself. The event structure displays two default events, namely the process of visualization

and the resulting state. These events are temporally ordered and is headed by the state (e_2) event. The formal role in the qualia structure represents the act of visualization. The agentive quale is specified for the feature [Event] to the notion of seeing.

Class 14

Prefix: **ubu**

Suffix: **-o**

ububono (quality of seeing)

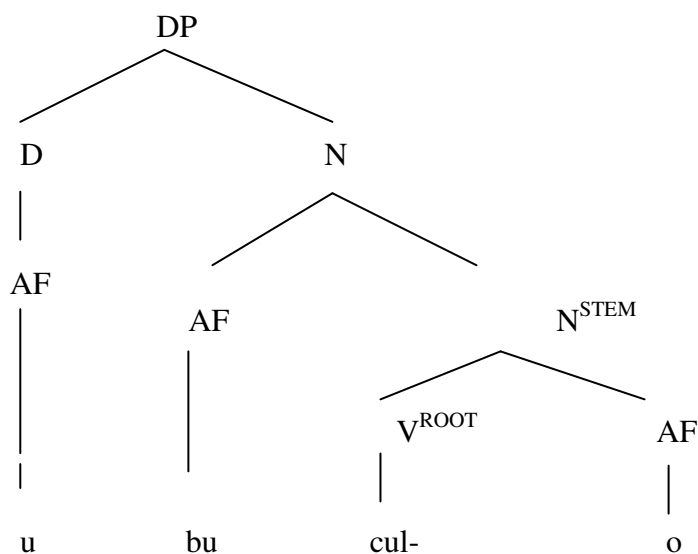

Nominalisation in class 14

ububono (quality of vision)

7. Ububono begqwetha basindisa indoda enkundleni.

(The quality vision of the attorney saved the man in court).

ububono

ARGSTR = ARG 1 = $e : r$

D - ARG 1 = X : phys. object)

D - ARG 2 = location

EVSTR = D - E 1 = e_1 : process

D - E 2 = e_2 : state

Restr = Temporally ordered

Head = e_2

QUALIA = FORMAL = **bona**_result (e_1 , x, y)

AGENTIVE = **-bona**_act_Quality (e_1 , x)

Hierarchy of semantic concepts

Arrive - Location - Motion - Event

The lexical semantic representation of **-ububono** above displays three arguments in its argument structure. Two of these arguments are default arguments. These are the physical object that is saved and the location at which the saving occurs. The other argument is the reference (r) of the event of visualization by itself. The event structure displays two default events, namely the process of visualizing and the resulting state. These events are temporally ordered and is headed by the state (e₂) event. The formal role in the qualia structure represents the act of visualization.

Observation regarding the analysis of transitive verbs of perception:

The above analysis of deverbatives derived from transitive perception verbs demonstrate that:

A. Transitive perception verbs take an animate argument, the event is a process and one formal quale occurs in terms of which the animate argument is in a process of being seen (e₁, x).

B. Nominalisation in class 1

The analysis reflects the analysis of the transitive verb **bona** in (1) above except that the argument is only human, hence the semantic concepts refers to this feature, that is, [human]. The presence of the prefix **um-** and the suffix **-i** compositionally realize an interpretation of human for **umboni**.

C. Nominalisation in class 7

The class 7 deverbative noun **isiboni** with the suffix **-i** denotes the feature human. The analysis of class 7 **isiboni** in (3) above, is similar to that of class 1 nominalisation in (2). The only difference relates to the agentive quale which displays the feature [intensive] introduced by the prefix **isi-** in class 7. The deverbative noun **isiboni** can appear as a head in a NP taking a descriptive possessive realized as a cognate noun .

D. **Nominalisation in class 9**

The class 9 deverbative **imboni** in (5) above can be analysed in a similar way to class 7, the only difference relates to the agentive quale which displays the feature [expert] introduced by the prefix **-im** in class 9.

E. **Nominalisation in class 3**

The argument **umbono** in class 3 in (5) above, refers to the process of seeing. The argument is shown in the formal quale (x) to refer to the act of seeing. In addition the feature [Manner] appears in the agentive quale.

F. **Nominalisation in class 11**

The argument **ubono** in class 11 can be analysed in a similar way to (5) above. The only difference relates to the agentive quale which demonstrates the feature [Event] introduced by the prefix **u(lu-)**. In class 11 the deverbative noun **ubono**, refers to an individual level nominal which is defined to a particular event.

G. **Nominalisation in class 14**

The argument **ububono** in class 14 can be analysed in a similar way to class 11 in (6) above. The only difference relates to the agentive quale which exhibits the feature [Quality] introduced by the prefix **ubu**. In class 14 the deverbative noun **ububono** refers to the stage level nominal which is defined to a particular event.

The other deverbatives derived from transitive verbs of perception can be derived and analysed in a similar way. These deverbatives are mostly specified for all classes of nouns with the exception of the noun class 5, which is denotes [derogatory].

Most deverbative nouns derived from class 9 denote an (expert) person where the nominal suffix is **-i**, however, where the nominal suffix is **-o**, a result interpretation is exhibited, as can be illustrated in the lexical semantic representation of **injongo** (intention) below:

injongo	
ARGSTR	= ARG 1 = e : r D – ARG 1 = X : phys. object)
EVSTR	= D - E 1 = e ₁ : process D - E 2 = e ₂ : state Restr = Temporally ordered Head = e ₂
QUALIA	= FORMAL = (e _r , x, y) AGENTIVE = -jonga_ Result (e ₁ , x)

The deverbative nouns in class 9 denote an expert person where the nominal suffix is **-i**, but in circumstances where the nominal suffix is **-o**, a [Result] interpretation is shown. Most deverbatives in class 11 denote a feature [Event] whereas class 14 deverbatives denote a feature [Quality].

In summary, the examples of deverbatives derived from transitive verbs of perception demonstrate that these deverbatives are mostly prevalent in class 1, class 7, class 11 and to a lesser degree class 14 as is illustrated in sub-section 4.3.3 of chapter 4. The deverbatives in class 1 and class 7 denote count nouns where the nominal suffix is **-i**. There is only one deverbative in class 7, **isiva** which denotes state where the nominal suffix is **-a**. Only one deverbative in class 7, **isijongo**, denotes artefact where the nominal suffix is **-o**. In class 9 only one deverbative **ingqwalasela** denotes action where the nominal suffix is **-a**.

The deverbative in class 11, **uqwalaselo**, denotes action where the nominal suffix is **-o**. The deverbatives in class 14 denote quality where the nominal suffix is **-i**, **-o** or **-a**, respectively. The deverbatives denoting humans where the nominal suffix is **-i** can readily be associated with corresponding plural nouns, however, the deverbatives in class 9 which have other semantic features do not readily take a corresponding plural form. It is evident that the set of lexical semantic representations of the range of nominals derived from the transitive perception verbs in sub-section 4.3.3 of chapter 4 can be analysed in terms of a similar lexical semantic representations presented in sub-section 5.3.3 of chapter 5 as is demonstrated in the analysis of the perception verb **jonga** in sub-section 5.3.3 above.

5.3.4 Search verbs

In section 4.3 sub-section 4.3.4 the transitive search verbs were analysed in terms of their deverbatives in noun classes 1, 3, 7, 9, 11 and 14. In the following section 5.3 sub-section 5.3.4 the deverbatives from the verb **funa** are examined in terms of their use. The various deverbatives derived from the transitive search verb **funa** demonstrate a semantic type such as Person, Event/ Manner of event, Action/Result, Instrument and Quality as specified in sub-section 5.3.4 of chapter 5.

Nominalisation from – funa (want, search, look)

The verb **funa** (want, search, look)

1. Inkwenkwe ifuna inkomo.
(The boy is searching for a cow).

-funa	
ARGSTR	= ARG 1 = x : human D - ARG 1 = animate
EVSTR	= E 1 = e ₁ : process E 2 = e ₂ : state Restr(ucturing) = Temporally ordered Head = e ₂
QUALIA	= FORMAL = funa _result (e ₂ , y) AGENTIVE = -funa _act (e ₁ , x, y)

Hierarchy of semantic concepts

Search - Process - Act

The lexical semantic representation of **funa** can be explained as displaying two arguments in its argument structure. One argument denotes the entity (individual) searching (for something) and the other arguments is a default argument. The events are temporally ordered and is headed by the state (e₂) event. The formal role in the qualia structure represents the act of seeing.

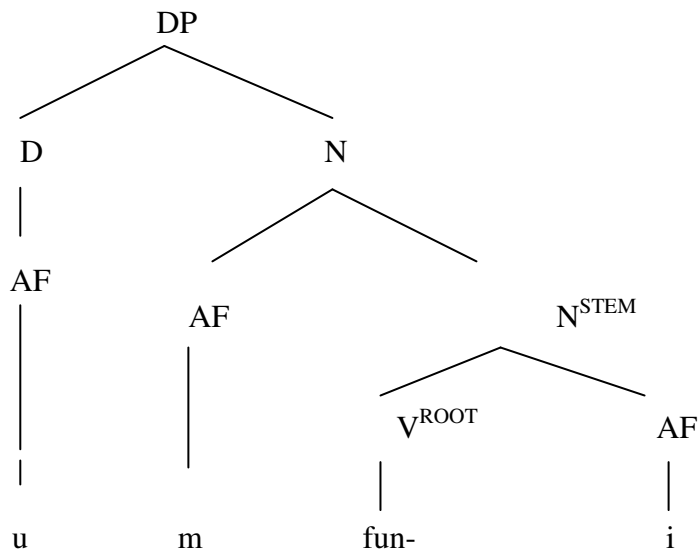
Class 1Prefix: **um-**Suffix: **-i****umfuni** (person who searches)**Nominalisation in class 1****umfuni** (person who searches)

2. Umfuni wafumana imali.
(The searching person found money).

umfuni

ARGSTR = ARG 1 = x : human

D - ARG 1 = y : phys. obj

EVSTR = E 1 = e₁ : processE 2 = e₂ : state

Restr(ucturing) = Temporally ordered

Head = e₂QUALIA = FORMAL = **bona_** result (e₂, y)AGENTIVE = **-bona_** act (e₁, x, y)

Hierarchy of semantic concepts

Search - Process - Actor - Human

The lexical semantic representation of **-umfuni** in (2) above displays that in its argument structure it has two arguments; the one argument is the human who finds (something), and the other argument is the default argument (i.e. the inanimate). The presence of the prefix **um** and the suffix **-i** compositionally realise an interpretation of human for **umfuni**. The event structure displays two default events, namely the process of seeing and the resulting state. These events are temporally ordered and is headed by the state (e_2) event. The formal role in the qualia structure represents the act of seeing.

Class 7

Prefix: **isi-**

Suffix: **-i**

isifuni (person who frequently searches (for something))

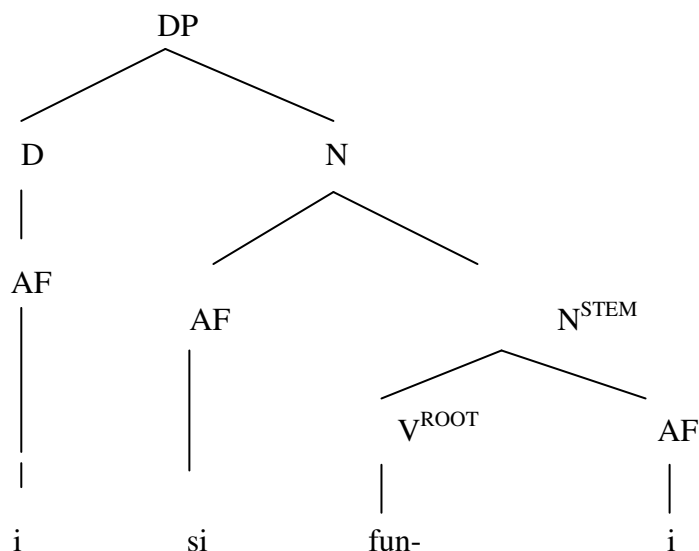

Nominalisation in class 7

isifuni (person who frequently searches (for something))

3. Isifuni sakhangelela abantwana.
(The frequently seeking person looked for the children).

isifuni	
ARGSTR	= ARG 1 = x : human D - ARG 1 = y: animate
EVSTR	= D - E 1 = e ₁ : process D - E 2 = e ₂ : state Restr = Temporally ordered Head = e ₂
QUALIA	= FORMAL = funa _result (e _r , x, y) AGENTIVE = -funa _act_intensity (e ₁ , x)

Hierarchy of semantic concepts

Search - Intensive - Actor – Human

The lexical semantic representation of the deverbative noun **isifuni** in (3) above, can be explained in a similar way to the representation of **umfuni** in (2) above. The only difference relates to the agentive quale which in addition has the feature [intensive] to the notion of searching. The event structure displays two default events, namely the process of searching and the resulting state. These events are temporally ordered and is headed by the state (e₂) event. The formal role in the qualia structure represents the act of searching.

Class 9

Prefix: **im-**

Suffix: **-i**

imfuni (a person who is an expert in searching)

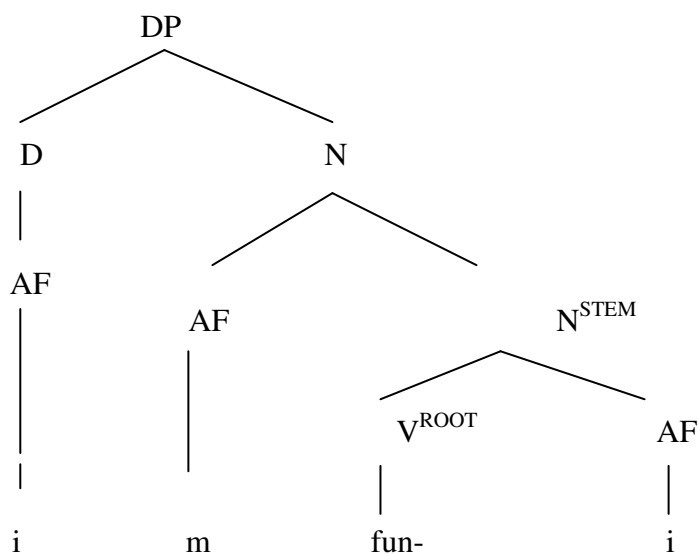

Nominalisation in class 9

imfuni (a person who is an expert in searching)

4. Imfuni yabhaqa amasela.
(The expert searching person found the thieves).

imfuni	
ARGSTR	= ARG 1 = x : human D – ARG 1 = y : animate
EVSTR	= D - E 1 = e ₁ : process D - E 2 = e ₂ : state Restr = Temporally ordered Head = e ₂
QUALIA	= FORMAL = funa _result (e _r , x, y) AGENTIVE = -funa _act_expert (e ₁ , x)

Hierarchy of semantic concepts

Search - Expert - Actor – Human

The lexical semantic representation of the deverbative noun **imfuni** in (4) above, can be explained in a similar way to the representation of **umfuni** in (2) above. The only difference relates to the agentive quale which in addition has the feature [expert] to the notion of searching.

Class 3

Prefix: **um-**

Suffix: **-o**

umfuno (way of (searching))

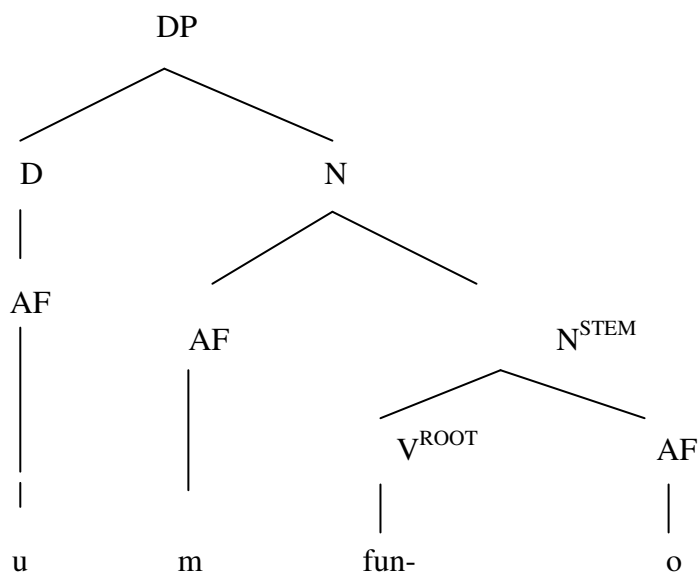

Nominalisation in class 3

umfuno (way of (searching))

5. Umfuno wemoto wenziwa ngamapolisa.
(The searching for the car was done by the police).

umfuno	
ARGSTR	= ARG 1 = e : r D - ARG 1 = animate
EVSTR	= D - E 1 = e ₁ : process D - E 2 = e ₂ : state Restr = Temporally ordered Head = e ₂
QUALIA	= FORMAL = (e _r , x, y) AGENTIVE = -funa _ act [Manner] (e ₁ , x)

Hierarchy of semantic concepts

Search - Process - Act - Manner

The lexical semantic representation of the deverbative **-umfuno** in (5) above displays two arguments in its argument structure; one of which is a default argument (i.e. the animate argument). The first argument ARG 1, displays the reference (r) of the event of searching by itself. The event structure displays two default events, namely the process of searching and the resulting state. These events are temporally ordered and is headed by the state (e₂) event.

The formal role in the qualia structure represents the act of searching. The deverbative noun **umfuno** can appear as a head in a NP taking a descriptive possessive realized as a cognate noun as is illustrated in (5) .

Class 11

Prefix: **u(lu-)**

Suffix: **-o**

umfuno (searching)

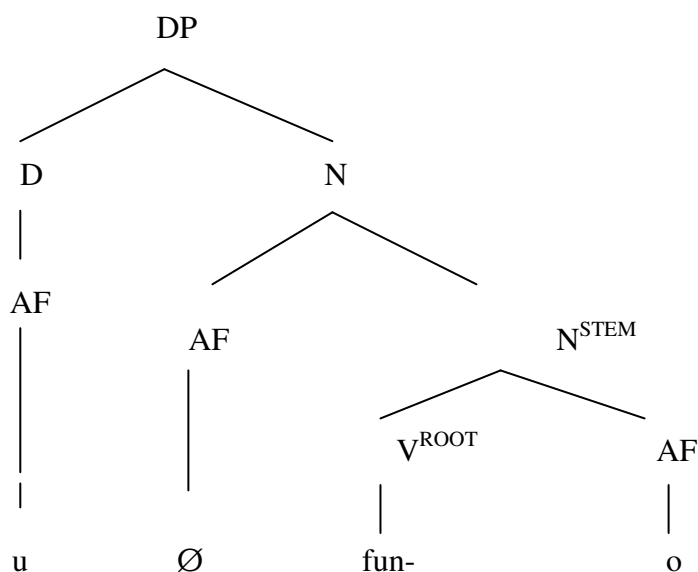

Nominalisation in class 11

umfuno (searching)

6. Ufuno lwenqanawa lwayekwa ngahlanguli.
 (The searching for the ship was abandoned by the rescue unit).

umfuno	
ARGSTR	= ARG 1 = e : r D - ARG 1 = y : animate
EVSTR	= D - E 1 = e ₁ : process D - E 2 = e ₂ : state Restr = Temporally ordered Head = e ₂
QUALIA	= FORMAL = funa _result(e _r , x, y) AGENTIVE = -funa _act [Event] (e ₁ , x)

Hierarchy of semantic concepts

Search - Location - Process - Result - Event

The lexical semantic representation of the deverbative **-ufuno** in (6) above has an explanation similar to that in (5) above. The distinguishing difference relates to the agentive quale, where in (6), the agentive quale is specified for the feature [Event] which is absent in (5).

Class 14

Prefix: **ubu**

Suffix: **-o**

ubufuno (quality of searching)

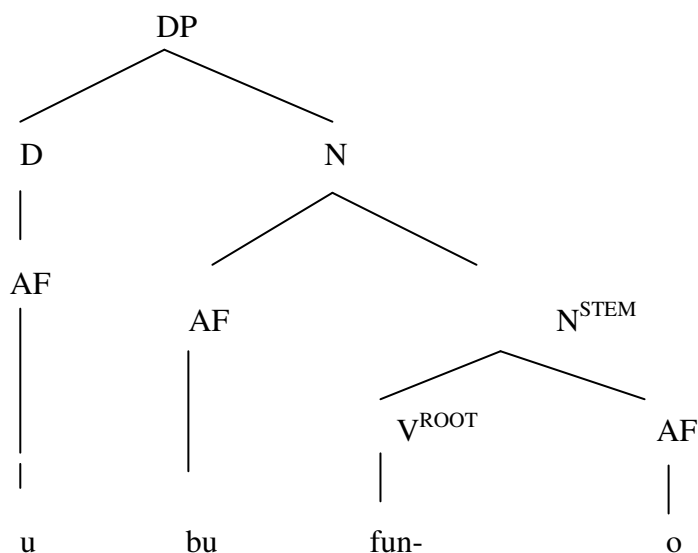

Nominalisation in class 14

ubufuno (quality of searching)

7. Ubufuno bomalusi basindisa iinkomo emaseleni.
(The quality searching of the shepherd saved the cows from the thieves).

ubufuno	
ARGSTR	= ARG 1 = e : r D – ARG 1 = X : phys. object) D - ARG 2 = location
EVSTR	= D - E 1 = e ₁ : process D - E 2 = e ₂ : state Restr = Temporally ordered Head = e ₂
QUALIA	= FORMAL = funa_result (e ₁ , x, y) AGENTIVE = -funa_act_Quality (e ₁ , x)

Hierarchy of semantic concepts

Search - Location - Process - Quality

The lexical semantic representation of **-ubufuno** above displays three arguments in its argument structure. Two of these arguments are default arguments. These are the physical object that is being searched and the location at which the searching occurs. The other argument is the reference (r) of the event of quality searching by itself. The event structure displays two default events, namely the process of searching and the resulting state. These events are temporally ordered and is headed by the state (e₂) event. The formal role in the qualia structure represents the quality of searching.

Observation regarding the analysis of transitive verbs of search:

The above analysis of deverbatives derived from transitive search verbs demonstrate that:

- A. Transitive search verbs take an animate argument, the event is a process and one formal quale occurs in terms of which the animate argument is in a process of being seen (e₁, x).

B. Nominalisation in class 1

The analysis reflects the analysis of the transitive verb **funa** in (1) above except that the argument is only human, hence the semantic concepts refers to this feature, that is, [human]. The presence of the prefix **um-** and the suffix **-i** compositionally realize an interpretation of human for **umfuni**.

C. Nominalisation in class 7

The class 7 deverbative noun **isifuni** with the suffix **-i** denotes the feature human. The analysis of class 7 **isifuni** in (3) above, is similar to that of class 1 nominalisation in (2). The only difference relates to the agentive quale which displays the feature [intensive] introduced by the prefix **isi-** in class 7. The deverbative noun **isifuni** can appear as a head in a NP taking a descriptive possessive realized as a cognate noun .

D. Nominalisation in class 9

The class 9 deverbative **imfuni** in (5) above can be analysed in a similar way to class 7, the only difference relates to the agentive quale which displays the feature [expert] introduced by the prefix **-im** in class 9.

E. Nominalisation in class 3

The argument **umfuno** in class 3 in (5) above, refers to the process of searching. The argument is shown in the formal quale (x) to refer to the act of searching. In addition the feature [Manner] appears in the agentive quale.

F. Nominalisation in class 11

The argument **ufuno** in class 11 can be analysed in a similar way to (5) above. The only difference relates to the agentive quale which demonstrates the feature [Event] introduced by the prefix **u(lu-)**. In class 11 the deverbative noun **ufuno**, refers to an individual level nominal which is defined to a particular event.

G. Nominalisation in class 14

The argument **ubufuno** in class 14 can be analysed in a similar way to class 11 in (6) above. The only difference relates to the agentive quale which exhibits the feature [Quality] introduced by the prefix **ubu**. In class 14 the deverbative noun **ubufuno** refers to the stage level nominal which is defined to a particular event.

The other deverbatives derived from transitive search verbs can be derived and analysed in a similar way. These deverbatives are mostly specified for all classes of nouns with the exception of the noun class 5, which is absent. Most deverbative nouns derived from class 9 denote an (expert) person where the nominal suffix is **-i**, however, where the nominal suffix is **-o**, a result interpretation is exhibited, as can be illustrated in the lexical semantic representation of **imfuno** (need, desire, wish) below:

imfuno	
ARGSTR	= ARG 1 = e : r D - ARG 1 = X : phys. object)
EVSTR	= D - E 1 = e ₁ : process D - E 2 = e ₂ : state Restr = Temporally ordered Head = e ₂
QUALIA	= FORMAL = (e _r , x, y) AGENTIVE = -funa_ Result (e ₁ , x)

In summary, the examples of deverbatives derived from transitive search verbs demonstrate that these deverbatives are mostly prevalent in class 1, class 7, class 11 and class 14. The deverbatives in class 1 and class 7 denote count nouns where the nominal suffix is **-i**. In class 3 and class 11, the deverbatives denote event where the nominal suffix is **-o**. There is only one deverbative in class 9, **impicotho**, denoting action where the nominal suffix is **-o**. The deverbative in class 9, **imfuno**, denotes action or result where the nominal suffix is **-o**.

The deverbatives in class 14 denote quality where the nominal suffix is **-i** or **-o**. There are only two deverbatives in class 7, **isifuni** and **isilondoloz** in class 7 denoting instrument where the nominal suffix is **-i**. The deverbatives denoting humans where the nominal suffix is **-i**

can readily be associated with corresponding plural nouns, however, the deverbatives in class 9 which have other semantic features do not readily take a corresponding plural form, as can be shown with the uncharacteristic deverbative ***iimpicotho**. It is evident that the set of lexical semantic representations of the range of nominals derived from the transitive search verbs with a locative argument in sub-section 4.3.4 of chapter 4 can be analysed in terms of a similar lexical semantic representations presented in sub-section 5.3.4 of chapter 5 as is demonstrated in the analysis of the search verb **funa** in sub-section 5.3.4 above.

5.3.5 Verbs of ingesting / consumption

In section 4.3 sub-section 4.3.5 the transitive verbs of ingesting were analysed in terms of their deverbatives in noun classes 1, 3, 5, 7, 9, 11 and 14. In the following section 5.3 sub-section 5.3.5 the deverbatives from the verb **ginya** are examined in terms of their use. The various deverbatives derived from the transitive search verb **ginya** demonstrate a semantic type such as Person, Event/ Manner of event, Action/Result, Instrument and Quality as specified in sub-section 5.3.5 of chapter 5.

Nominalisation from – **ginya** (swallow)

The verb **ginya** (swallow)

1. Inkwenkwe iginye inyama.
(The boy is swallowed the meat).

-ginya	
ARGSTR	= ARG 1 = x : human D - ARG 1 = inanimate
EVSTR	= E 1 = e ₁ : process E 2 = e ₂ : state Restr(ucturing) = Temporally ordered Head = e ₂
QUALIA	= FORMAL = ginya _result (e ₂ , y) AGENTIVE = -ginya _act (e ₁ , x, y)

Hierarchy of semantic concepts

Swallow - Process - Act

The lexical semantic representation of **ginya** can be explained as displaying two arguments in its argument structure. One argument denotes the entity (individual) swallowing (something) and the other arguments is a default argument. The events are temporally ordered and is headed by the state (e_2) event. The formal role in the qualia structure represents the act of seeing.

Class 1

Prefix: **um-**

Suffix: **-i**

umginyi (person who swallows)

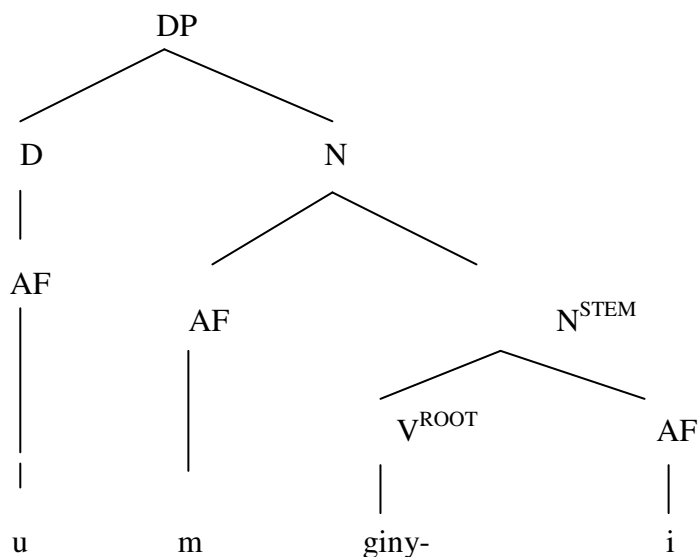

Nominalisation in class 1

umginyi (person who swallows)

2. Umginyi watya ukutya.
(The swallowing person ate food).

umginyi	
ARGSTR	= ARG 1 = x : human D - ARG 1 = y : phys. obj
EVSTR	= E 1 = e ₁ : process E 2 = e ₂ : state Restr(ucturing) = Temporally ordered Head = e ₂
QUALIA	= FORMAL = ginya _ result (e ₂ , y) AGENTIVE = -ginya _ act (e ₁ , x, y)

Hierarchy of semantic concepts

Swallow - Process - Actor - Human

The lexical semantic representation of **-umginyi** in (2) above displays that in its argument structure it has two arguments; the one argument is the human who swallows (something), and the other argument is the default argument (i.e. the inanimate). The presence of the prefix **um** and the suffix **-i** compositionally realise an interpretation of human for **umginyi**. The event structure displays two default events, namely the process of swallowing and the resulting state. These events are temporally ordered and is headed by the state (e₂) event. The formal role in the qualia structure represents the act of swallowing.

Class 7

Prefix: **isi-**

Suffix: **-i**

isiginyi (person who frequently swallows (something))

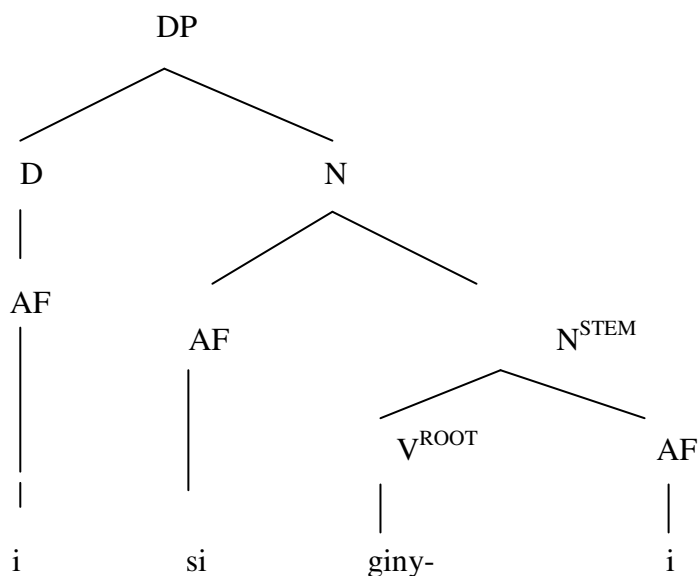

Nominalisation in class 7

isiginyi (person who frequently swallows (something))

3. Isiginyi sahlafuna ukutya.
(The frequently swallowing person chewed the food).

isiginyi	
ARGSTR	= ARG 1 = x : human D - ARG 1 = y: animate
EVSTR	= D - E 1 = e ₁ : process D - E 2 = e ₂ : state Restr = Temporally ordered Head = e ₂
QUALIA	= FORMAL = ginya _result (e _r , x, y) AGENTIVE = -ginya _act_intensity (e ₁ , x)

Hierarchy of semantic concepts

Swallow - Intensive - Actor – Human

The lexical semantic representation of the deverbative noun **isiginyi** in (3) above, can be explained in a similar way to the representation of **umfuni** in (2) above. The only difference relates to the agentive quale which in addition has the feature [intensive] to the notion of

swallowing. The event structure displays two default events, namely the process of swallowing and the resulting state. These events are temporally ordered and is headed by the state (e_2) event. The formal role in the qualia structure represents the act of swallowing.

Class 3

Prefix: **um-**

Suffix: **-o**

umginyo (way of (swallowing))

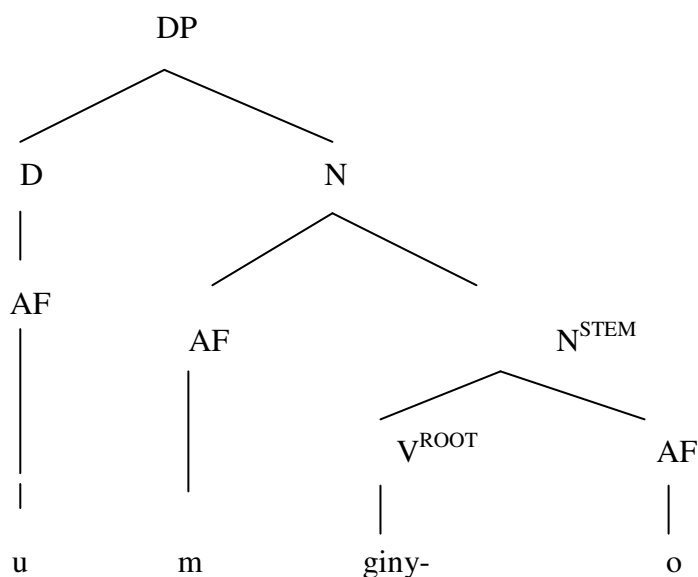

Nominalisation in class 3

umginyo (way of (swallowing))

5. Umginyo wenja mkhulu.
(The swallowing of the dog is big).

umginyo	
ARGSTR	= ARG 1 = $e:r$ D - ARG 1 = animate
EVSTR	= D - E 1 = e_1 : process D - E 2 = e_2 : state Restr = Temporally ordered Head = e_2
QUALIA	= FORMAL = (e_r, x, y) AGENTIVE = -ginya _ act [Manner] (e_1, x)

Hierarchy of semantic concepts

Swallow - Process - Act - Manner

The lexical semantic representation of the deverbative **-umginyo** in (5) above displays two arguments in its argument structure; one of which is a default argument (i.e. the animate argument). The first argument ARG 1, displays the reference (r) of the event of swallowing by itself. The event structure displays two default events, namely the process of swallowing and the resulting state. These events are temporally ordered and is headed by the state (e_2) event. The formal role in the qualia structure represents the act of swallowing. The deverbative noun **umginyo** can appear as a head in a NP taking a descriptive possessive realized as a cognate noun as is illustrated in (5) .

Class 9

Prefix: **in-**

Suffix: **-o**

inginyo (act of (swallowing))

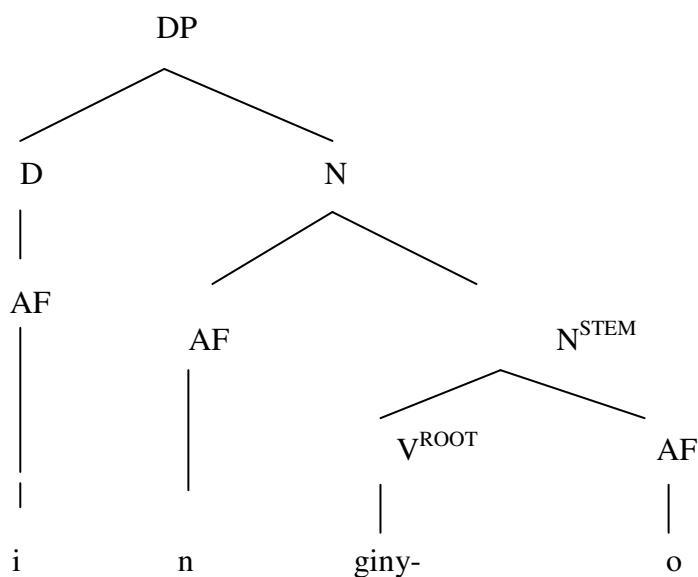

Nominalisation in class 9

inginyo (act of (swallowing))

6. Inginyo ekhawulezileyo yabangela ukomiwa komntwana.
(The sudden swallowing caused the choking of the child).

inginyo	
ARGSTR	= ARG 1 = e : r D - ARG 1 = y : animate
EVSTR	= D - E 1 = e ₁ : process D - E 2 = e ₂ : state Restr = Temporally ordered Head = e ₂
QUALIA	= FORMAL = ginya _result(e _r , x, y) AGENTIVE = -ginya _ act [Action] (e ₁ , x)

Hierarchy of semantic concepts

Swallow - Process - Result - Action

The lexical semantic representation of the deverbative **-inginyo** in (6) above has an explanation similar to that in (5) above. The distinguishing difference relates to the agentive quale, where in (6), the agentive quale is specified for the feature [Action] which is absent in (5).

Class 11

Prefix: **u(lu-)**

Suffix: **-o**

uginyo (swallowing)

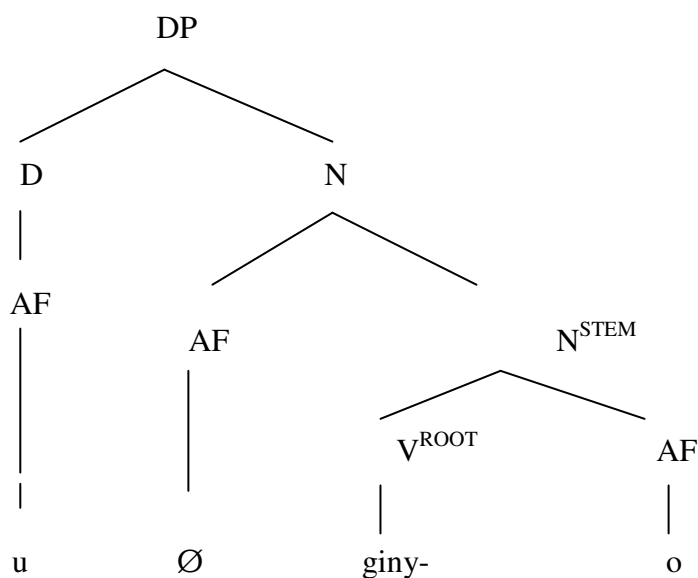

Nominalisation in class 11

uginyo (swallowing)

7. Uginyo lokutya lwenzeka ngokukhawuleza.
(The swallowing of food happened quickly).

uginyo	
ARGSTR	= ARG 1 = e : r D - ARG 1 = y : animate
EVSTR	= D - E 1 = e ₁ : process D - E 2 = e ₂ : state Restr = Temporally ordered Head = e ₂
QUALIA	= FORMAL = ginya _result(e _r , x, y) AGENTIVE = -ginya _ act [Event] (e ₁ , x)

Hierarchy of semantic concepts

Swallow - Process - Result - Event

The lexical semantic representation of the deverbative **-uginyo** in (7) above has an explanation similar to that in (6) above. The distinguishing difference relates to the agentive quale, where in (7), the agentive quale is specified for the feature [Event] which is absent in (6).

Class 14

Prefix: **ubu**

Suffix: **-o**

ubuginyo (quality of swallowing)

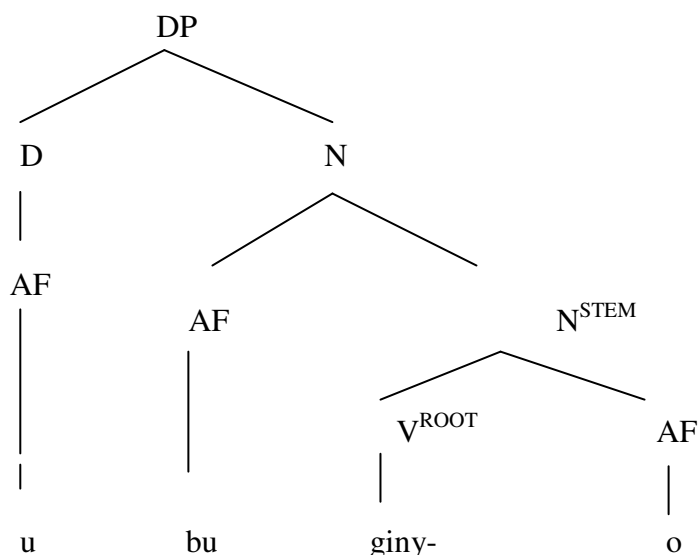

Nominalisation in class 14

ubuginyo (quality of swallowing)

8. Ubuginyo bosana bavuyisa umzali.

(The quality swallowing of the baby made the parent happy).

ubuginyo

ARGSTR = ARG 1 = e : r

D - ARG 1 = animate

EVSTR = D - E 1 = e₁ : process

D - E 2 = e₂ : state

Restr = Temporally ordered

Head = e₂

QUALIA = FORMAL = **ginya**_result (e₁, x, y)

AGENTIVE = **-ginya** _act_ Quality (e₁, x)

Hierarchy of semantic concepts

Swallow - Process - Quality

The lexical semantic representation of **-ubuginyo** above displays two arguments in its argument structure. One of these arguments is a default arguments (i.e. animate). The other argument is the reference (r) of the event of quality swallowing by itself. The event structure displays two default events, namely the process of swallowing and the resulting state. These events are temporally ordered and is headed by the state (e₂) event. The formal role in the qualia structure represents the act of swallowing.

Observation regarding the analysis of transitive verbs of ingesting / consumption:

The above analysis of deverbatives derived from transitive verbs of ingesting / consumption demonstrate that:

- A. Transitive ingesting / consumption verbs take an animate argument, the event is a process and one formal quale occurs in terms of which the animate argument is in a process of swallowing (e_1, x).

B. Nominalisation in class 1

The analysis reflects the analysis of the transitive verb **ginya** in (1) above except that the argument is only human, hence the semantic concepts refers to this feature, that is, [human]. The presence of the prefix **um-** and the suffix **-i** compositionally realize an interpretation of human for **umginyi**.

C. Nominalisation in class 7

The class 7 deverbative noun **isiginyi** with the suffix **-i** denotes the feature human. The analysis of class 7 **isiginyi** in (3) above, is similar to that of class 1 nominalisation in (2). The only difference relates to the agentive quale which displays the feature [intensive] introduced by the prefix **isi-** in class 7. The deverbative noun **isifuni** can appear as a head in a NP taking a descriptive possessive realized as a cognate noun .

D. Nominalisation in class 3

The argument **umginyo** in class 3 in (5) above, refers to the process of swallowing. The argument is shown in the formal quale (x) to refer to the act of swallowing. In addition the feature [Manner] appears in the agentive quale.

E. Nominalisation in class 9

The class 9 deverbative **inginyo** in (6) above can be analysed in a similar way to class 5, the only difference relates to the agentive quale which displays the feature [Action] introduced by the prefix **-in** in class 9.

F. Nominalisation in class 11

The argument **uginyo** in class 11 can be analysed in a similar way to (6) above. The only difference relates to the agentive quale which demonstrates the feature [Event] introduced by the prefix **u(lu-)**. In class 11 the deverbative noun **uginyo**, refers to an individual level nominal which is defined to a particular event.

G. Nominalisation in class 14

The argument **ubuginyo** in class 14 can be analysed in a similar way to class 11 in (7) above. The only difference relates to the agentive quale which exhibits the feature [Quality] introduced by the prefix **ubu**. In class 14 the deverbative noun **ubuginyo** refers to the stage level nominal which is defined to a particular event.

The other deverbatives derived from transitive ingesting verbs can be derived and analysed in a similar way. These deverbatives are mostly specified for all classes of nouns with the exception of the noun class 5, which is absent in most derived nominals. Most deverbative nouns derived from class 9 denote an (expert) person where the nominal suffix is **-i**, however, where the nominal suffix is **-o**, a result interpretation is exhibited, as can be illustrated in the lexical semantic representation of **isiselo** (soft drink) below:

imfuno	
ARGSTR	= ARG 1 = e : r D - ARG 1 = X : phys. object)
EVSTR	= D - E 1 = e ₁ : process D - E 2 = e ₂ : state Restr = Temporally ordered Head = e ₂
QUALIA	= FORMAL = (e _r , x, y) AGENTIVE = -sela_ Result (e ₁ , x)

In summary, the examples of deverbatives derived from transitive verbs of ingesting / consumption demonstrate that these deverbatives are mostly prevalent in class 1 class 7 and

class 11. The deverbatives in class 1 and class 7 denote count nouns where the nominal suffix is **-i**. The deverbatives in class 9, **intlafuno**, **umtyiso** in class 3, and **isityo** and **isiselo** in class 7, denote result where the nominal suffix is **-o**. Only one deverbative in class 9, **inginyo**, denotes result or action. Only one deverbative in class 9, **intselo**, denotes action where the nominal suffix is **-o** as is demonstrated in the lexical schematic representation in sub-section 4.3.5 of chapter 4.

The deverbative in class 7, **isitya**, is the only deverbative from this group of deverbatives which denotes instrument where the nominal suffix is **-a**. The deverbatives in class 14 denote quality where the nominal suffix is **-o**. The deverbatives denoting humans where the nominal suffix is **-i** can readily be associated with corresponding plural nouns, however, the deverbatives in class 9 which have other semantic features do not readily take a corresponding plural form, as can be illustrated with the uncharacteristic deverbatives ***izinginyo** and ***izintselo**, respectively. It is evident that the set of lexical semantic representations of the range of nominals derived from the transitive verbs of ingesting in sub-section 4.3.5 of chapter 4 can be analysed in terms of a similar lexical semantic representations presented in sub-section 5.3.5 of chapter 5 as is demonstrated in the analysis of the ingesting verb **ginya** in sub-section 5.3.5 above.

5.3.6 Verbs of cognition

Levin (1993) described these verb classes in sub-section 4.3.6 of chapter 4. In section 4.3 sub-section 4.3.6 the transitive verbs of cognition were analysed in terms of their deverbatives in noun classes 1, 3, 7, 9, 11 and 14. In the following section 5.3 sub-section 5.3.6 the deverbatives from the verb **qonda** are examined in terms of their use. The various deverbatives derived from the transitive verbs of cognition illustrate a semantic type such as Person, Event, Action/Result and Quality.

Nominalisation from – **qonda** (understand)

The verb **qonda** (understand)

1. Umfundi uyaziqonda izibalo.
(The student understands mathematics).

-qonda	
ARGSTR	= ARG 1 = x : human D - ARG 1 = inanimate
EVSTR	= E 1 = e_1 : process E 2 = e_2 : state Restr(ucturing) = Temporally ordered Head = e_2
QUALIA	= FORMAL = qonda _result (e_2 , y) AGENTIVE = -qonda _act (e_1 , x , y)

Hierarchy of semantic concepts

Swallow - Process - Act

The lexical semantic representation of **qonda** can be explained as displaying two arguments in its argument structure (ARGSTR). One argument denotes the entity (individual) understanding (something) and the other arguments is a default argument. The events are temporally ordered and is headed by the state (e_2) event. The formal role in the qualia structure represents the act of understanding.

Class 1

Prefix: **um-**

Suffix: **-i**

umqondi (a person who understands)

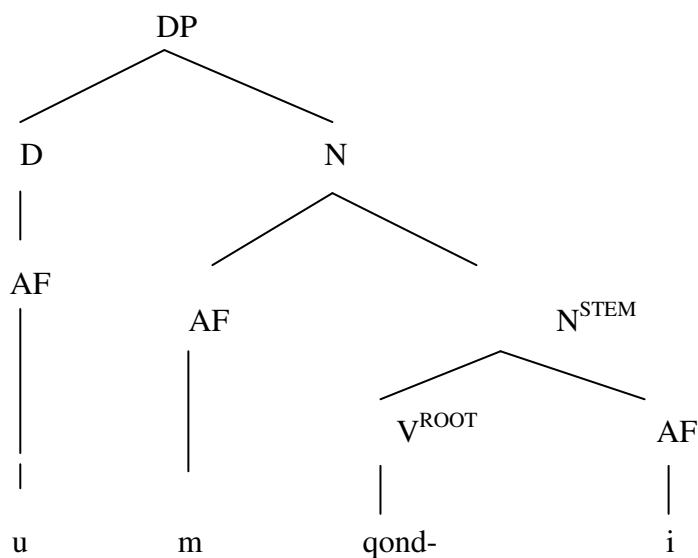

Nominalisation in class 1**umqondi** (a person who understands)

2. Umqondi uphumelele iimviwo.
(The person who understands passed his examinations).

umqondi	
ARGSTR	= ARG 1 = x : human D - ARG 1 = y : inanimate
EVSTR	= E 1 = e ₁ : process E 2 = e ₂ : state Restr(ucturing) = Temporally ordered Head = e ₂
QUALIA	= FORMAL = qonda _result (e ₂ , y) AGENTIVE = -qonda _act (e ₁ , x, y)

Hierarchy of semantic concepts

Understand - Process - Actor - Human

The lexical semantic representation of **-umqondi** in (2) above displays that in its argument structure it has two arguments; the one argument is the human who understands (something), and the other argument is the default argument (i.e. the inanimate). The presence of the prefix **um** and the suffix **-i** compositionally realise an interpretation of human for **umqondi**. The event structure displays two default events, namely the process of understanding and the resulting state. These events are temporally ordered and is headed by the state (e₂) event. The formal role in the qualia structure represents the act of understanding.

Class 7Prefix: **isi-**Suffix: **-i****isiqondi** (person who often understands (something))

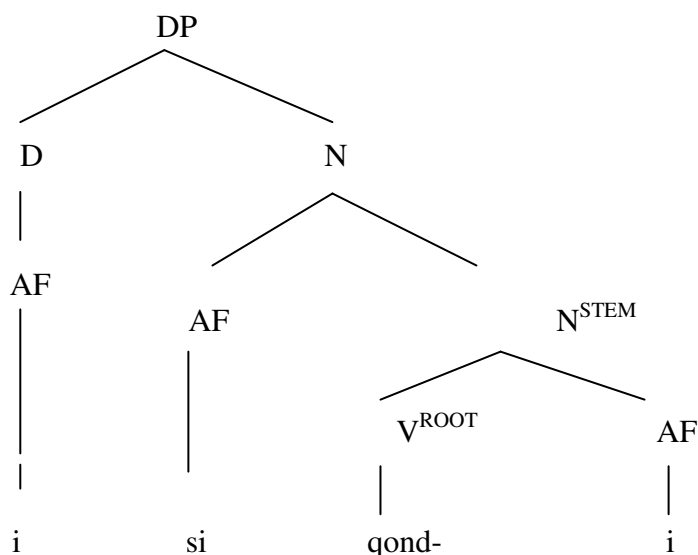

Nominalisation in class 7

isiqondi (person who often understands (something))

3. Isiqondi sasombulula ingxaki yezibalo.

(The person who often understands solved the mathematics problem).

isiqondi	
ARGSTR	= ARG 1 = x : human D - ARG 1 = y: animate
EVSTR	= D - E 1 = e ₁ : process D - E 2 = e ₂ : state Restr = Temporally ordered Head = e ₂
QUALIA	= FORMAL = qonda _result (e _r , x, y) AGENTIVE = -qonda _act_intensity (e ₁ , x)

Hierarchy of semantic concepts

Understand - Intensive - Actor – Human

The lexical semantic representation of the deverbative noun **isiqondi** in (3) above, can be explained in a similar way to the representation of **umqondi** in (2) above. The only difference relates to the agentive quale which in addition has the feature [intensive] to the notion of understanding. The event structure displays two default events, namely the process of

understanding and the resulting state. These events are temporally ordered and is headed by the state (e_2) event. The formal role in the qualia structure represents the act of understanding.

Class 9

Prefix: **in-**

Suffix: **-i**

ingqondi (a person who is an expert in understanding)

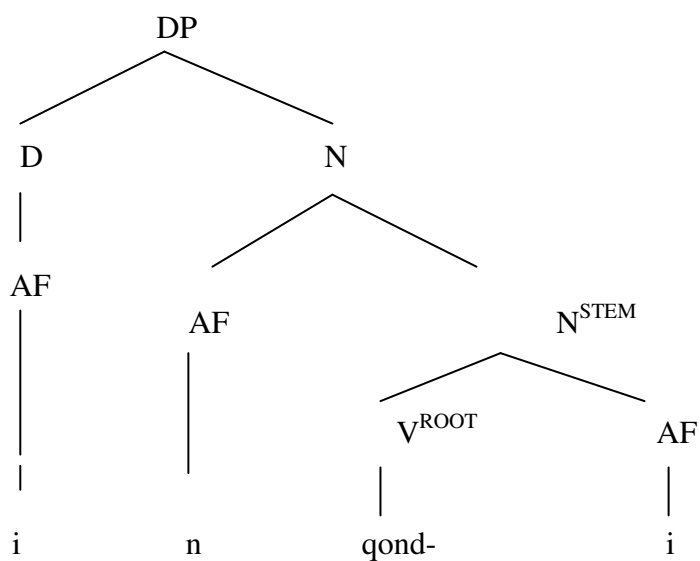

Nominalisation in class 9

ingqondi (a person who is an expert in understanding)

4. Ingqondi yafundela ubunjini.
(The expert person who understands studied engineering).

ingqondi	
ARGSTR	= ARG 1 = e : r D - ARG 1 = y : inanimate
EVSTR	= D - E 1 = e ₁ : process D - E 2 = e ₂ : state Restr = Temporally ordered Head = e ₂
QUALIA	= FORMAL = qonda _result (e _r , x, y) AGENTIVE = -qonda _act_expert (e ₁ , x)

Hierarchy of semantic concepts

Understand - Expert - Actor – Human

The lexical semantic representation of the deverbative noun **ingqondi** in (4) above, can be explained in a similar way to the representation of **umqondi** in (2) above. The only difference relates to the agentive quale which in addition has the feature [expert] to the notion of understanding.

Class 3

Prefix: **um-**

Suffix: **-o**

umqondo (way of (understanding))

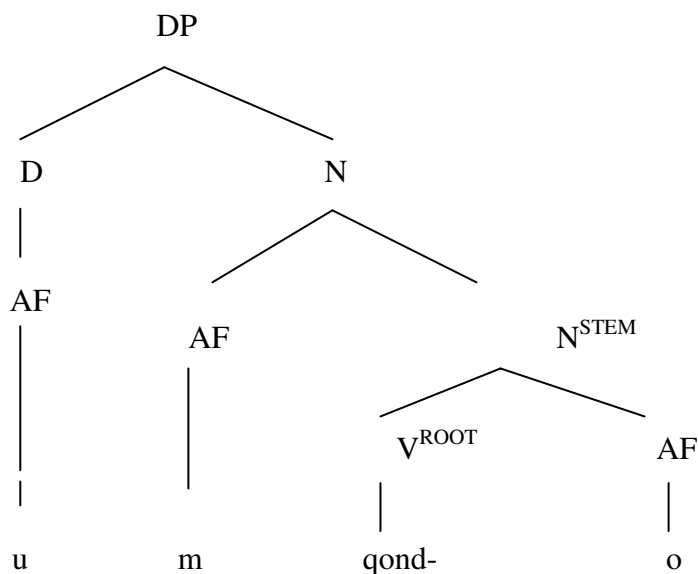

Nominalisation in class 3

umqondo (way of (understanding))

5. Umqondo wamayeza wamenza wafundela ubusokhemisi.
(The understanding of medicines made him study phamarcy).

umqondo	
ARGSTR	= ARG 1 = e : r D - ARG 1 = inanimate
EVSTR	= D - E 1 = e ₁ : process D - E 2 = e ₂ : state Restr = Temporally ordered Head = e ₂
QUALIA	= FORMAL = (e _r , x, y) AGENTIVE = -qonda _ act [Manner] (e ₁ , x)

Hierarchy of semantic concepts

Understand - Process - Act - Manner

The lexical semantic representation of the deverbative **-umqondo** in (5) above displays two arguments in its argument structure; one of which is a default argument (i.e. the animate argument). The first argument ARG 1, displays the reference (r) of the event of understanding by itself. The event structure displays two default events, namely the process of understanding and the resulting state. These events are temporally ordered and is headed by the state (e₂) event. The formal role in the qualia structure represents the act of understanding. The deverbative noun **umqondo** can appear as a head in a NP taking a descriptive possessive realized as a cognate noun as is illustrated in (5) .

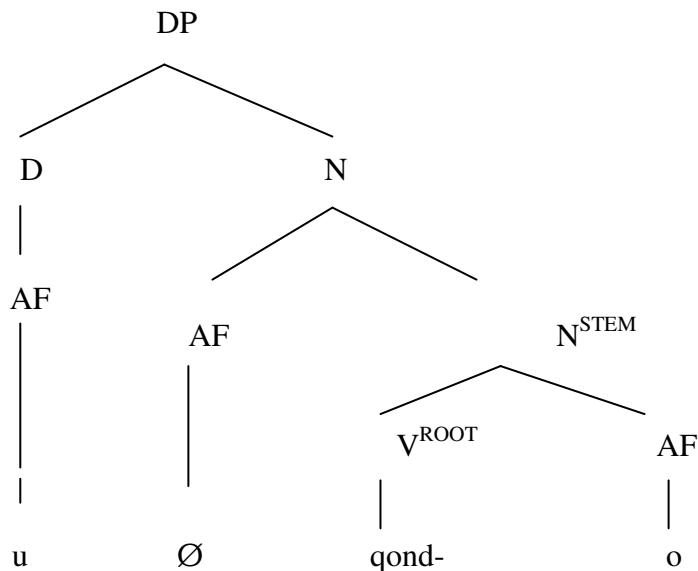
Class 11Prefix: **u(lu-)**Suffix: **-o****uqondo** (understanding)**Nominalisation in class 11****uqondo** (understanding)

6. Uqondo lwezibalo lwamnceda kubunjinieli.
(The understanding of mathematics helped him in engineering).

uqondo	
ARGSTR	= ARG 1 = e : r D - ARG 1 = y : inanimate
EVSTR	= D - E 1 = e ₁ : process D - E 2 = e ₂ : state Restr = Temporally ordered Head = e ₂
QUALIA	= FORMAL = qonda _result(e _r , x, y) AGENTIVE = -qonda _act [Event] (e ₁ , x)

Hierarchy of semantic concepts

Swallow - Process - Result - Event

The lexical semantic representation of the deverbative **-uqondo** in (6) above has an explanation similar to that in (5) above. The distinguishing difference relates to the agentive quale, where in (6), the agentive quale is specified for the feature [Event] which is absent in (5).

Class 14

Prefix: **ubu**

Suffix: **-o**

ubuqondo (quality of understanding)

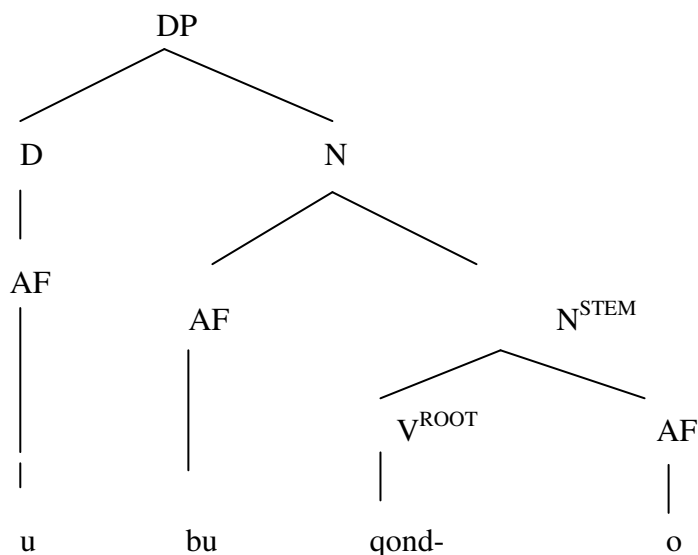

Nominalisation in class 14

ubuqondo (quality of understanding)

7. Ubuqondo bamanani bamnceda umfundi.
(The quality understanding of numbers helped the student).

ubuqondo	
ARGSTR	= ARG 1 = e : r D - ARG 1 = animate
EVSTR	= D - E 1 = e ₁ : process D - E 2 = e ₂ : state Restr = Temporally ordered Head = e ₂
QUALIA	= FORMAL = qonda _ result (e ₁ , x, y) AGENTIVE = -qonda _ act _ Quality (e ₁ , x)

Hierarchy of semantic concepts

Understand - Process - Quality

The lexical semantic representation of **-ubuqondo** above displays two arguments in its argument structure (ARGSTR). One of these arguments is a default arguments (i.e. animate). The other argument is the reference (r) of the event of quality understanding by itself. The event structure (EVSTR) displays two default events, namely the process of understanding and the resulting state. These events are temporally ordered and is headed by the state (e₂) event. The formal role in the qualia structure represents the quality of understanding.

Observation regarding the analysis of transitive verbs of cognition:

The above analysis of deverbatives derived from transitive verbs of cognition demonstrate that:

- A. Transitive cognition verbs take an animate argument, the event is a process and one formal quale occurs in terms of which the animate argument is in a process of swallowing (e₁, x).
- B. **Nominalisation in class 1**

The analysis reflects the analysis of the transitive verb **qonda** in (1) above except that the argument is only human, hence the semantic concepts refers to this feature, that is,

[human]. The presence of the prefix **um-** and the suffix **-i** compositionally realize an interpretation of human for **umqondi**.

C. **Nominalisation in class 7**

The class 7 deverbative noun **isiqondi** with the suffix **-i** denotes the feature human. The analysis of class 7 **isiqondi** in (3) above, is similar to that of class 1 nominalisation in (2). The only difference relates to the agentive quale which displays the feature [intensive] introduced by the prefix **isi-** in class 7. The deverbative noun **isiqondi** can appear as a head in a NP taking a descriptive possessive realized as a cognate noun .

D. **Nominalisation in class 3**

The argument **umqondo** in class 3 in (5) above, refers to the process of understanding. The argument is shown in the formal quale (x) to refer to the act of understanding. In addition the feature [Manner] appears in the agentive quale.

E. **Nominalisation in class 9**

The class 9 deverbative **ingqondi** in (6) above can be analysed in a similar way to class 7, the only difference relates to the agentive quale which displays the feature [expert] introduced by the prefix **-in** in class 9.

F. **Nominalisation in class 11**

The argument **uqondo** in class 11 can be analysed in a similar way to (5) above. The only difference relates to the agentive quale which demonstrates the feature [Event] introduced by the prefix **u(lu-)**. In class 11 the deverbative noun **uqondo**, refers to an individual level nominal which is defined to a particular event.

G. **Nominalisation in class 14**

The argument **ubuqondo** in class 14 can be analysed in a similar way to class 11 in (6) above. The only difference relates to the agentive quale which exhibits the feature [Quality] introduced by the prefix **ubu**. In class 14 the deverbative noun **ubuqondo** refers to the stage level nominal which is defined to a particular event.

The other deverbatives derived from transitive cognition verbs can be derived and analysed in a similar way. These deverbatives are mostly specified for all classes of nouns with the exception of the noun class 5, which is absent in most derived nominals. Most deverbative nouns derived from class 7 denote a (habitual) person where the nominal suffix is **-i**, however, where the nominal suffix is **-o**, a result interpretation is exhibited, as can be illustrated in the lexical semantic representation of **isigwebo** (punishment) below:

isigwebo	
ARGSTR	= ARG 1 = e : r D - ARG 1 = x : human
EVSTR	= D - E 1 = e ₁ : process D - E 2 = e ₂ : state Restr = Temporally ordered Head = e ₂
QUALIA	= FORMAL = (e _r , x, y) AGENTIVE = -gweba _ Result (e ₁ , x)

In summary, the examples of deverbatives derived from transitive verbs of cognition demonstrate that these deverbatives are mostly prevalent in class 1, class 7, and class 11. The deverbatives in class 1 and class 7 denote count nouns where nominal suffix is **-i**. There is only one deverbative in class 7, **isigwebo**, denoting action or result where the nominal suffix is **-o**. There are only two deverbatives class 3, **umkhumbulo** and **umqondo**, denoting results where the nominal suffix is **-o**.

The deverbatives in class 11 denote event where the nominal suffix is **-o**. The deverbatives in class 14 denote quality where the nominal suffix is **-o**. The deverbatives denoting humans where the nominal suffix is **-i** can readily be associated with corresponding plural nouns, however, the deverbatives in class 9 which have other semantic features are not readily associated with a corresponding plural form, as can be shown with the irregular deverbatives ***izinkanyelo** and ***izingqaphelo**, respectively. It is evident that the set of lexical semantic representations of the range of nominals derived from the transitive verbs of cognition in sub-

section 4.3.6 of chapter 4 can be analysed in terms of a similar lexical semantic representations presented in sub-section 5.3.6 of chapter 5 as is demonstrated in the analysis of the cognition verb **qonda** in sub-section 5.3.6 above.

5.3.7 Contact verbs

Levin (1993) described these verb classes in sub-section 4.3.7 of chapter 4. In section 4.3 sub-section 4.3.7 the transitive contact verbs were analysed in terms of their deverbatives in noun classes 1, 3, 5, 7, 9, 11 and 14. In the following section 5.3 sub-section 5.3.7 the deverbatives from the verb **bamba** are examined in terms of their use. The various deverbatives derived from the transitive contact verb demonstrate a semantic type such as Person, Event/ Manner of event, Action/Result, Instrument and Quality as specified in sub-section 5.3.7 of chapter 5.

Nominalisation from – **bamba** (hold, catch)

The verb **bamba** (hold, catch)

1. Ipolisa libamba isela.
(The policeman is catching a thief).

-bamba	
ARGSTR	= ARG 1 = x : human D - ARG 1 = animate
EVSTR	= E 1 = e ₁ : process E 2 = e ₂ : state Restr(ucturing) = Temporally ordered Head = e ₂
QUALIA	= FORMAL = bamba _result (e ₂ , y) AGENTIVE = -bamba _ act (e ₁ , x, y)

Hierarchy of semantic concepts

Catch - Act

The lexical semantic representation of the verb **bamba** can be explained as displaying two arguments in its argument structure. One argument denotes the entity (individual) doing the catching and the other arguments is a default argument. The events are temporally ordered

and is headed by the state (e_2) event. The formal role in the qualia structure represents the act of catching.

Class 1

Prefix: **um-**

Suffix: **-i**

umbambi (person who holds / catches (something))

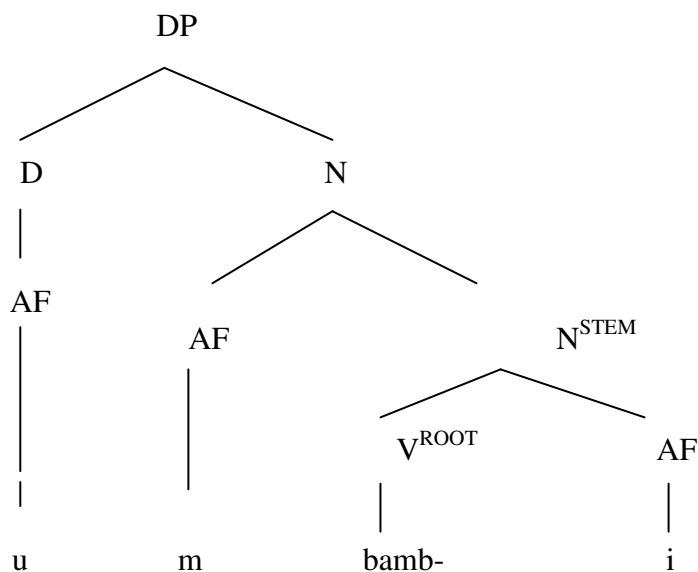

Nominalisation in class 1

umbambi (person who holds / catches (something))

2. Umbambi volovolo wadubula umhlaseli.
(The holder of the gun shot the attacker).

-umbambi

ARGSTR = ARG 1 = human

D - ARG 1 = y : animate

EVSTR = E 1 = e_1 : process

E 2 = e_2 : state

Restr(ucturing) = Temporally ordered

Head = e_2

QUALIA = FORMAL = **bamba_** result (e_2 , y)

AGENTIVE = **-bamba_** act (e_1 , x, y)

Hierarchy of semantic concepts

Hold - Process - Actor - Human

The lexical semantic representation of the deverbative noun **-umbambi** in (2) above displays that in its argument structure it has two arguments; the one argument is the human who holds onto (something), and the other argument is the default srgument (i.e. the animate). The presence of the prefix **um** and the suffix **-i** compositionally realise an interpretation of human for **umculi**. The event structure displays two default events, namely the process of holding and the resulting state. These events are temporally ordered and is headed by the state (e_2) event. The formal role in the qualia structure represents the act of holding.

Class 5

Prefix: **i(li-)**

Suffix: **-a**

ibamba (person who holds / catches (something))

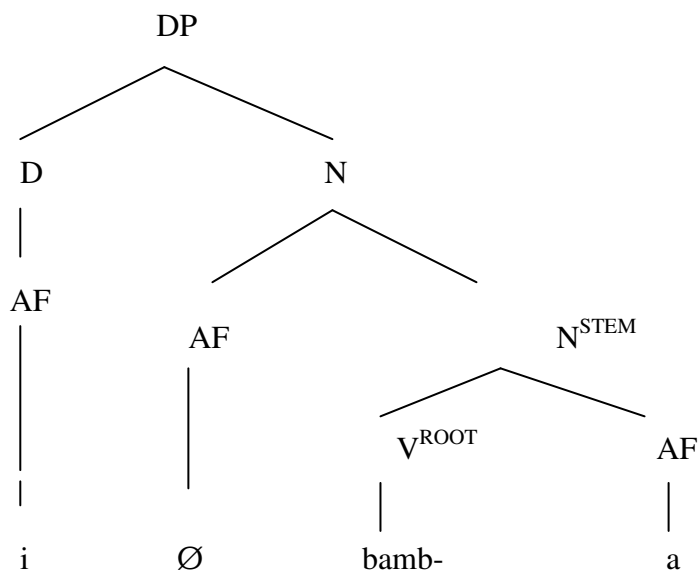

Nominalisation in class 5

ibamba (a person who holds / catches (something))

3. Ibamba layekelela intambo.
(The holder loosened the rope).

-ibamba	
ARGSTR	= ARG 1 = x : human D - ARG 1 = y : inanimate
EVSTR	= E 1 = e ₁ : process E 2 = e ₂ : state Restr(ucturing) = Temporally ordered Head = e ₂
QUALIA	= FORMAL = bamba _result (e ₂ , y) AGENTIVE = -bamba _act [expert] (e ₁ , x, y)

Hierarchy of semantic concepts

Hold - Process - Actor - Human

The explanation of the lexical semantic representation of the deverbative noun **ibamba** is similar to that of **umbambi** in (2) above. The distinguishing difference relates to the formal quale which exhibits the feature [expert] in (3), which is absent in (2).

Class 7

Prefix: **isi-**

Suffix: **-i**

isibambi (person who habitually holds (something))

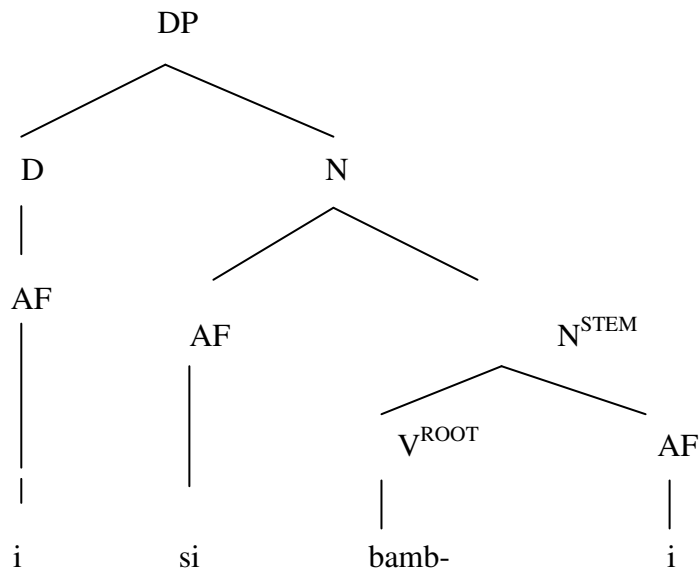

Nominalisation in class 7

isibambi (person who habitually holds (something))

4. Isibambi saleqeka emva kwamasela.
(The person who habitually holds something chased after the thieves).

isibambi	
ARGSTR	= ARG 1 = x : human D - ARG 1 = y: animate
EVSTR	= D - E 1 = e ₁ : process D - E 2 = e ₂ : state Restr = Temporally ordered Head = e ₂
QUALIA	= FORMAL = bamba_result (e _r , x, y) AGENTIVE = -bamba_act_intensity (e ₁ , x)

Hierarchy of semantic concepts

Hold - Intensive - Actor – Human

The lexical semantic representation of the deverbative noun **isibambi** in (4) above, can be explained in a similar way to the representation of **umbambi** in (2) above. The only difference relates to the agentive quale which in addition has the feature [intensive] to the notion of holding. The event structure displays two default events, namely the process of holding and the resulting state. These events are temporally ordered and is headed by the state

(e₂) event. The formal role in the qualia structure represents the act of holding. The deverbative noun **isibambi** can appear as a head in a NP taking a descriptive possessive realized as a cognate noun .

Class 3

Prefix: **um-**

Suffix: **-o**

umbambo (way of (holding / catching))

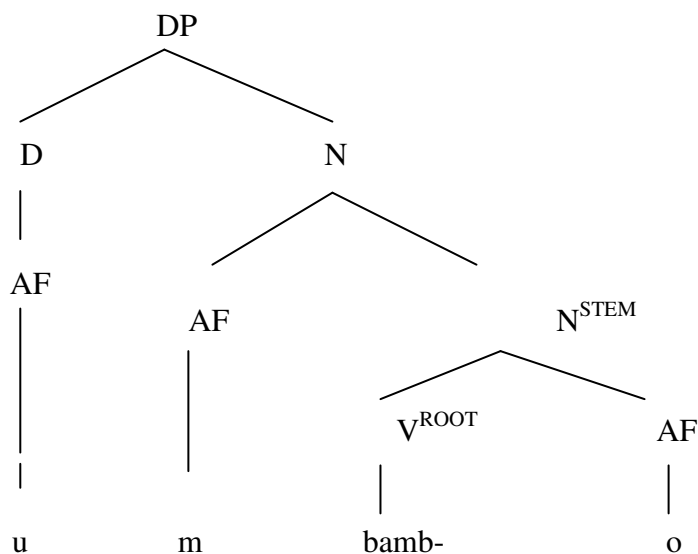

Nominalisation in class 3

umbambo (way of (holding / catching))

5. Umbambo wamasela wenziwa ngabahlali..
(The catching of the thieves was done by the community).

umbambo

ARGSTR = ARG 1 = e : r

D - ARG 1 = animate

EVSTR = D - E 1 = e₁ : process

D - E 2 = e₂ : state

Restr = Temporally ordered

Head = e₂

QUALIA = FORMAL = (e_r, x, y)

AGENTIVE = **-bamba** _ act [Manner] (e₁, x)

Hierarchy of semantic concepts

Catch - Process - Act - Manner

The lexical semantic representation of the deverbative **-umbambo** in (5) above displays two arguments in its argument structure; one of which is a default argument (i.e. the animate argument). The first argument ARG 1, displays the reference (r) of the event of catching by itself. The event structure displays two default events, namely the process of catching up and the resulting state. These events are temporally ordered and is headed by the state (e_2) event. The formal role in the qualia structure represents the act of catching.

Class 11

Prefix: **u(lu-)**

Suffix: **-o**

ubambo (act of catching / holding))

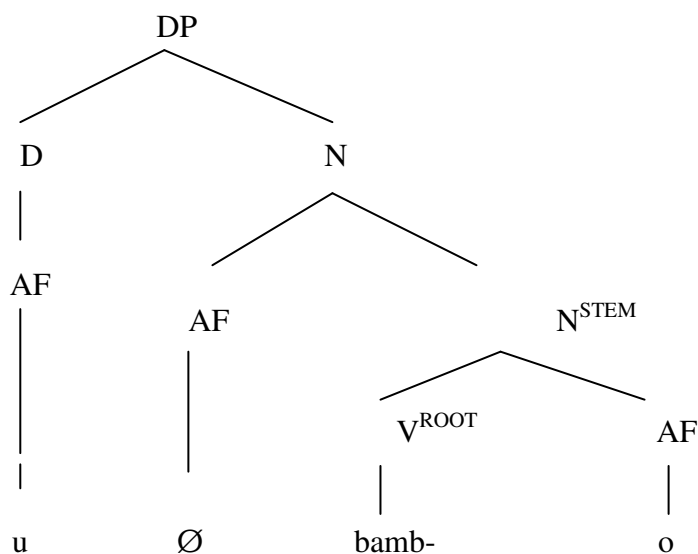

Nominalisation in class 11

ubambo (act of catching / holding)

6. Ubambo lwamasela lwathandwa ngabantu.
(The catching of the thieves was liked by the people).

ubambo	
ARGSTR	= ARG 1 = $e : r$ D - ARG 1 = animate
EVSTR	= D - E 1 = $e_1 : \text{process}$ D - E 2 = $e_2 : \text{state}$ Restr = Temporally ordered Head = e_2
QUALIA	= FORMAL = (e_r, x, y) AGENTIVE = -bamba _ act [Event] (e_1, x)

Hierarchy of semantic concepts

Catch - Process - Action

The explanation of the lexical semantic representation of the deverbative noun **ubambo** (6) above is similar to that of **umbambo** in (5) above. The distinguishing difference relates to the formal quale which exhibits the feature [Event] in (6), which is absent in (5).

Class 14

Prefix: **ubu**

Suffix: **-o**

ububambo (quality of catching)

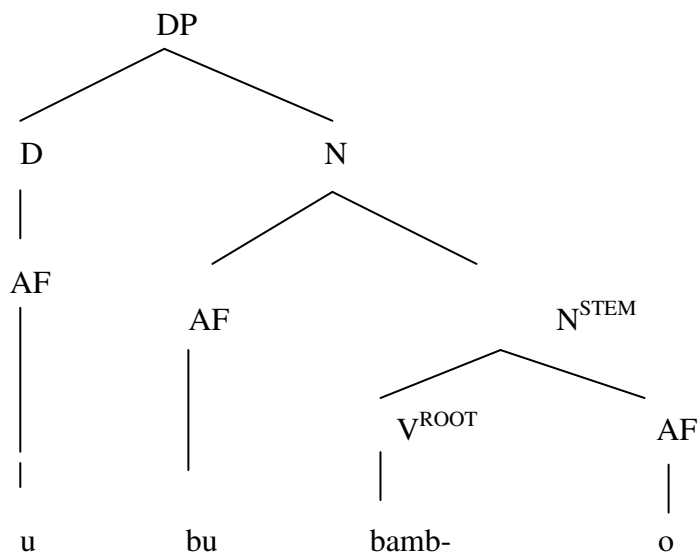

Nominalisation in class 14

ububambo (quality of the hold)

7. Ububambo besango baphulwe yinkwenkwe.

(The quality hold of the entrance has been broken by the boy).

ububambo	
ARGSTR	= ARG 1 = e : r D - ARG 1 = X : phys. object) D - ARG 2 = animate
EVSTR	= D - E 1 = e ₁ : process D - E 2 = e ₂ : state Restr = Temporally ordered Head = e ₂
QUALIA	= FORMAL = bamba result (e ₁ , x, y) AGENTIVE = -bamba _ act _ Quality (e ₁ , x)

Hierarchy of semantic concepts

Hold- Result - Quality

The lexical semantic representation of **-ububambo** in (7) above has an explanation similar to that in (6) above. The distinguishing difference relates to the formal quale, whereas the formal quale in (6) specifies the result of the event, the formal quale in (7) has the feature [Quality] which is absent in (6).

Class 7

Prefix: **isi-**

Suffix: **-o**

isibambo (holding instrument)

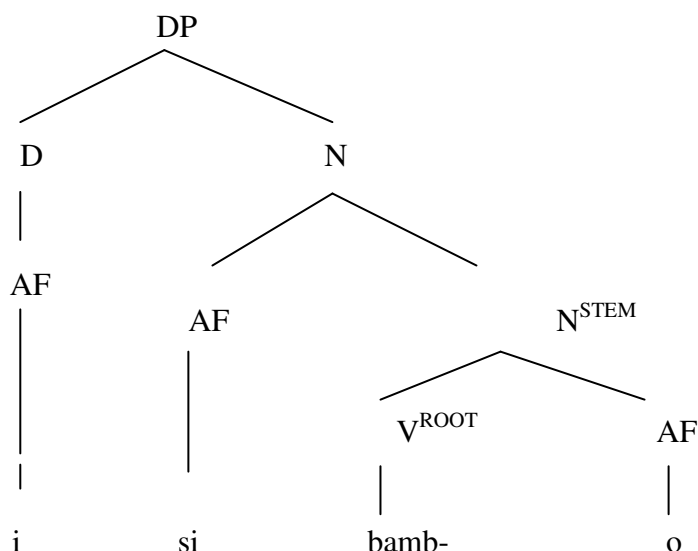

Nominalisation in class 7

isibambo (holding instrument)

8. Isibambo sembiza saphulwe yindoda.

(The handle of the pot has been broken by the man).

isibambo

ARGSTR = ARG 1 = e : r

D - ARG 1 = y: human

EVSTR = D - E 1 = e₁ : process

D - E 2 = e₂ : state

Restr = Temporally ordered

Head = e₂

QUALIA = FORMAL = (e_r, x, y)

AGENTIVE = **-bamba** _act_ instrument (e₁, x)

Hierarchy of semantic concepts

Hold – Act – Instrument

The lexical semantic representation of the deverbative **-isibambo** in (7) above displays two arguments in its argument structure; one of which is a default argument (i.e. the human argument). The first argument ARG 1, displays the reference (r) of the event of the holding instrument by itself. The event structure displays two default events, namely the process of the holding instrument and the resulting state. These events are temporally ordered and is

headed by the state (e_2) event. The formal role in the qualia structure represents the instrument for holding .

Observation regarding the analysis of contact transitive verbs:

The above analysis of deverbatives derived from the contact transitive verb can be illustrated as shown below:

- A. The transitive verb of contact can take an animate argument, the event is process and one formal quale occurs in terms of which the animate argument is in a process (of contact) (e_1, x).

B. Nominalisation in class 1

The analysis reflects the analysis of the transitive verb of contact **bamba** in (1) above, except that the argument is only human, hence the semantic concepts refers to this feature, that is, [Human]. The presence of the prefix **um** and the suffix **-i** compositionally realise an interpretation of human for **umbambi** in (2).

D. Nominalisation in class 5

The class 5 deverbative **ibamba** in (3) above can be analysed in a similar way to class 1, the only difference relates to the agentive quale which displays the feature [expert] introduced by the prefix **-i** in class 5.

C. Nominalisation in class 7

The class 7 deverbative noun **isibambi** with the suffix **-i** denotes the feature human. The analysis of class 7 **isibambi** in (4) above, is similar to that of class 5 nominalisation in (3). The only difference relates to the agentive quale which displays the feature [intensive] introduced by the prefix **isi-** in class 7. The deverbative **isibambo**, on the other hand, has an agentive quale which exhibits the feature [Instrument] introduced by the prefix **isi** and the suffix **-o** . In class 7 the deverbative

noun **isibambo** refers to a stage level nominal which is defined to a particular event in contrast to **isibambi** which refers to an individual level nominal..

D. Nominalisation in class 3

The argument **umbambo** in class 3 in (5) above, refers to the process of holding. The argument is shown in the formal quale (x) to refer to the act of holding. In addition the feature [Manner] appears in the agentive quale.

E. Nominalisation in class 11

The argument **ubambo** in class 11 can be analysed in a similar way to (5) above. The only difference relates to the agentive quale which demonstrates the feature [Event] introduced by the prefix **u(lu-)** in (6). In class 11 the deverbative noun **ubambo**, refers to an individual level nominal which is defined to a particular event.

F. Nominalisation in class 14

The argument **ububambo** in class 14 can be analysed in a similar way to class 11 in (6) above. The only difference relates to the agentive quale which exhibits the feature [Quality] introduced by the prefix **ubu** in (7). In class 14 the deverbative noun **ububambo** refers to a stage level nominal which is defined to a particular event.

The other deverbatives derived from the transitive verbs of contact can be derived and analysed in the same manner, except for cases where the deverbatives within the same class have different nominal suffixes. The example of the lexical semantic representation for **isihlabo** in class 7 demonstrates this difference, as is illustrated below:

9. Isihlabo sasika umntwana.
(The sharp instrument pierced the child).

isihlabo	
ARGSTR	= ARG 1 = phys. obj D – ARG 1 = y: human
EVSTR	= D - E 1 = e ₁ : process D - E 2 = e ₂ : state Restr = Temporally ordered Head = e ₂
QUALIA	= FORMAL = (e _r , x, y) AGENTIVE = -hlaba _act_ instrument (e ₁ , x)

In most cases the deverbatives in class 7 refer to habitual [person] in circumstances where the nominal suffix is **-i**, however in situations where the nominal suffix is **-o** the deverbative denotes an [instrument] not a human as demonstrated in the agentive quale of **isihlabo** above.

There are only two deverbative nouns that can be derived from this group of transitive contact verbs and they do not have a [derogatory] denotation.

In summary, the examples of deverbatives derived from transitive contact verbs demonstrate that these deverbatives are mostly prevalent in classes 1, class 7, class 11 and class 14. The deverbatives in class 1 and class 7 denote count nouns where the nominal suffix is **-i**. Only the deverbative in class 7, **isisiki**, denotes instrument where the nominal suffix is **-i**, whereas, the deverbatives **isibambo** and **isihlabo** have the nominal suffix **-o**. In class 3, the deverbatives denote event where the nominal suffix is **-o**. Only the deverbative **umbambo** in class 3 denotes result where the nominal suffix is **-o**. There are only two deverbatives in class 5 denoting humans where the nominal suffix is **-a**. Only one deverbative in class 11, **ubambo**, denotes action or result where the nominal suffix is **-o**.

The deverbatives in class 14 denote quality where the nominal suffix is **-o** or **-i**. The deverbatives denoting humans where the nominal suffix is **-i** can readily be associated with corresponding plural nouns, however, the deverbatives in class 9 which have other semantic features are not readily associated with a corresponding plural form, as can be illustrated with

the uncharacteristic deverbatives ***iintlakulo** and ***iintlasele**, respectively. It is evident that the set of lexical semantic representations of the range of nominals derived from the transitive contact verbs sub-section 4.3.7 of chapter 4 can be analysed in terms of a similar lexical semantic representations presented in sub-section 5.3.7 of chapter 5 as is demonstrated in the analysis of the contact verb **bamba** in sub-section 5.3.7 above.

5.3.8 Communication verbs

Levin (1993) cites Gropen et al (1989) in describing these verb classes in sub-section 4.3.8 of chapter 4. In section 4.3 sub-section 4.3.8 the communication verbs were analysed in terms of their deverbatives in noun classes 1, 3, 7, 9, 11 and 14. In the following section 5.3 sub-section 5.3.8 the deverbatives from the verb **khwaza** are examined in terms of their use. The various deverbatives derived from the communication verb **khwaza** demonstrate a semantic type such as Person, Event/ Manner of event, Action/Result, Instrument and Quality as specified in sub-section 5.3.8 of chapter 5.

Nominalisation from – **khwaza** (shout, call)

The verb **khwaza** (shout, call)

1. Umama ukhwaza umntwana.
(The mother is calling the child).

-khwaza	
ARGSTR	= ARG 1 = x : human D - ARG 1 = animate
EVSTR	= E 1 = e ₁ : process E 2 = e ₂ : state Restr(ucturing) = Temporally ordered Head = e ₂
QUALIA	= FORMAL = khwaza _result (e ₂ , y) AGENTIVE = -khwaza _act (e ₁ , x, y)

Hierarchy of semantic concepts

Call - Process - Act

The lexical semantic representation of the verb **khwaza** can be explained as displaying two arguments in its argument structure. One argument denotes the entity (human) doing the calling and the other argument is a default argument. The events are temporally ordered and is headed by the state (e_2) event. The formal role in the qualia structure represents the act of catching.

Class 1

Prefix: **um-**

Suffix: **-i**

umkhwazi (person who calls through shouting, wailer)

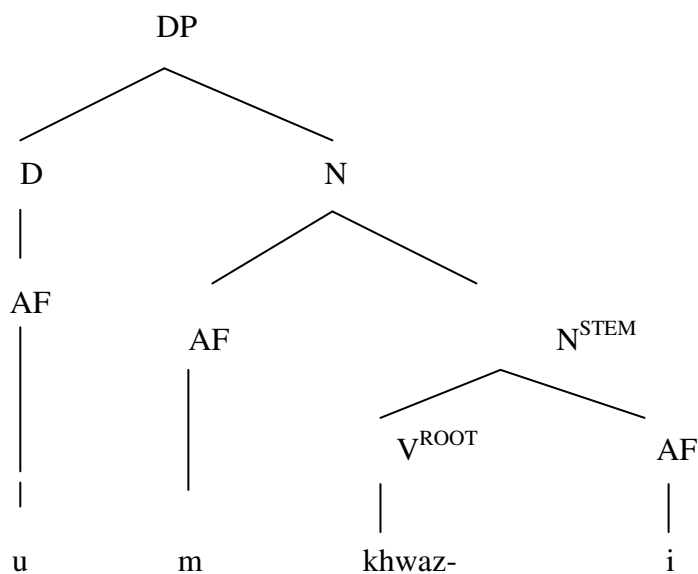

Nominalisation in class 1

umkhwazi (person who calls through shouting, wailer)

2. Umkhwazi wabiza amakwenkwe.
(The calling person called the boys).

umkhwazi	
ARGSTR	= ARG 1 = human D - ARG 1 = y : animate
EVSTR	= E 1 = e ₁ : process E 2 = e ₂ : state Restr(ucturing) = Temporally ordered Head = e ₂
QUALIA	= FORMAL = khwaza _ result (e ₂ , y) AGENTIVE = -khwaza _ act (e ₁ , x, y)

Hierarchy of semantic concepts

Call - Process - Actor - Human

The lexical semantic representation of **-umkhwazi** in (2) above displays that in its argument structure (ARGSTR) it has two arguments; the one argument is the human who calls (something), and the other argument is the default srgument (i.e. the animate). The presence of the prefix **um** and the suffix **-i** compositionally realise an interpretation of human for **umkhwazi**. The event structure (EVSTR) displays two default events, namely the process of calling and the resulting state. These events are temporally ordered and is headed by the state (e₂) event. The formal role in the qualia structure represents the act of calling.

Class 7

Prefix: **isi-**

Suffix: **-i**

isikhwazi (person who regularly calls through shouting)

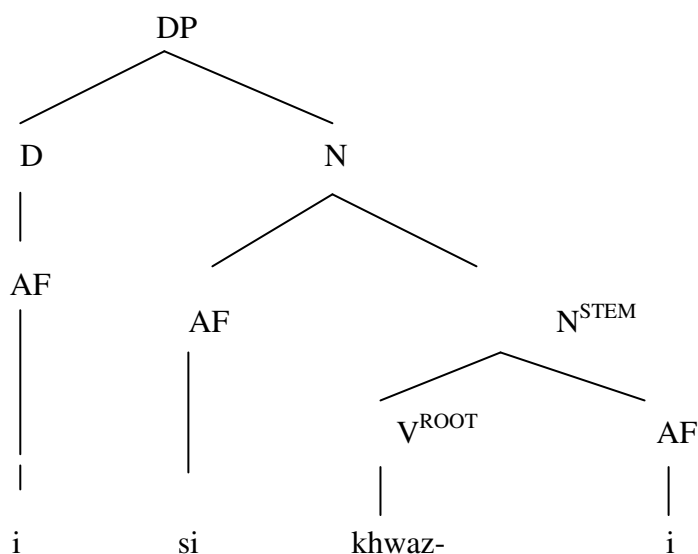

Nominalisation in class 7

isikhwazi (person who regularly calls through shouting)

3. Isikhwazi sabiza abantu.

(The person who regularly calls through shouting called the people).

isikhwazi	
ARGSTR	= ARG 1 = x : human D – ARG 1 = y: animate
EVSTR	= D - E 1 = e ₁ : process D - E 2 = e ₂ : state Restr = Temporally ordered Head = e ₂
QUALIA	= FORMAL = khwaza _result (e _r , x, y) AGENTIVE = -khwaza _act_intensity (e ₁ , x)

Hierarchy of semantic concepts

Call - Intensive - Actor – Human

The lexical semantic representation of **isikhwazi** in (3) above, can be explained in a similar way to the representation of **umkhwazi** in (2) above. The only difference relates to the agentive quale which in addition has the feature [intensive] to the notion of calling. The event structure displays two default events, namely the process of calling and the resulting state. These events are temporally ordered and is headed by the state (e₂) event. The formal role in the qualia structure represents the act of calling. The deverbative noun **isikhwazi** can appear as a head in a NP taking a descriptive possessive realized as a cognate noun .

Prefix: **isi-**

Suffix: **-o**

isikhwazo (calling instrument)

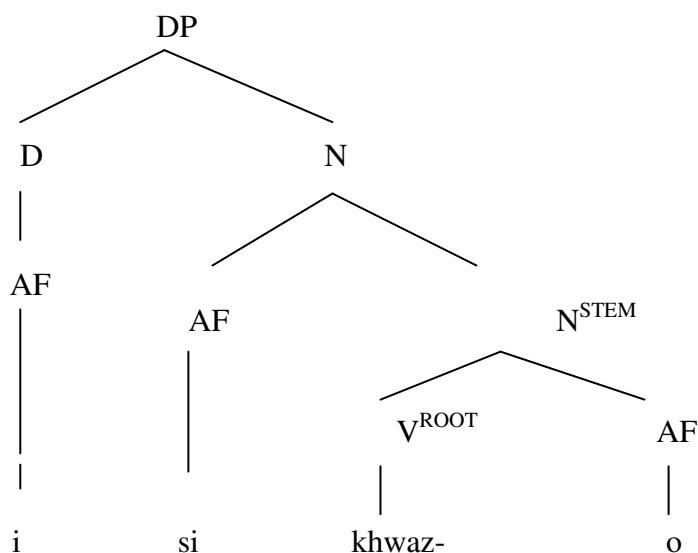

Nominalisation in class 7

isikhwazo (calling instrument)

4. Amadoda eva isikhwazo.
(The men heard the calling instrument).

isikhwazo	
ARGSTR	= ARG 1 = $e : r$ D - ARG 1 = animate
EVSTR	= D - E 1 = $e_1 : \text{process}$ D - E 2 = $e_2 : \text{state}$ Restr = Temporally ordered Head = e_2
QUALIA	= FORMAL = (e_r, x, y) AGENTIVE = -khwaza _ act [instrument] (e_1, x)

Hierarchy of semantic concepts

Call - Process - Act - Instrument

The lexical semantic representation of the deverbative **-isikhwazo** in (4) above displays two arguments in its argument structure; one of which is a default argument (i.e. the animate argument). The first argument ARG 1, displays the reference (r) of the event of the calling instrument by itself. The event structure displays two default events, namely the process of

calling and the resulting state. These events are temporally ordered and is headed by the state (e_2) event. The formal role in the qualia structure represents the act of calling.

Class 3

Prefix: **um-**

Suffix: **-o**

umkhwazo (way of (calling, shouting))

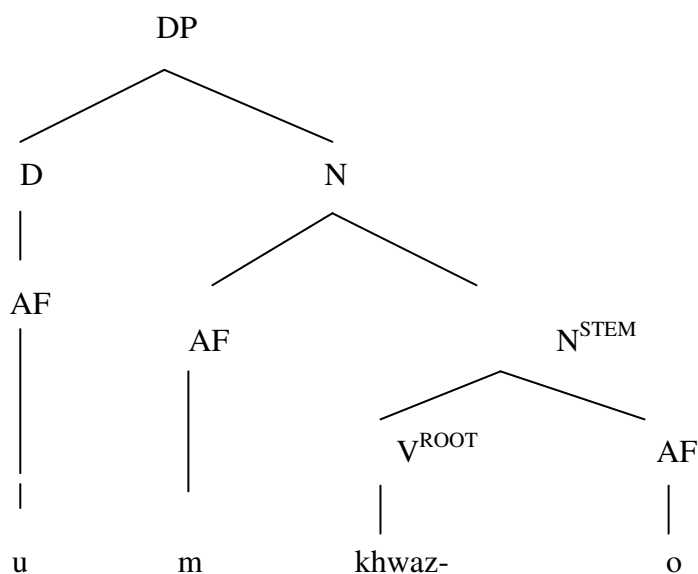

Nominalisation in class 3

umkhwazo (way of (calling, shouting))

5. Umkhwazo woyikisa izinja.
(The shouting frightened the dogs).

umkhwazo	
ARGSTR	= ARG 1 = $e : r$ D - ARG 1 = inanimate
EVSTR	= D - E 1 = $e_1 : \text{process}$ D - E 2 = $e_2 : \text{state}$ Restr = Temporally ordered Head = e_2
QUALIA	= FORMAL = (e_r, x, y) AGENTIVE = -khwaza _ act [Manner] (e_1, x)

Hierarchy of semantic concepts

Shout - Process - Act - Manner

The lexical semantic representation of the deverbative **-umkhwazo** in (5) above displays two arguments in its argument structure; one of which is a default argument (i.e. the animate argument). The first argument ARG 1, displays the reference (r) of the event of shouting by itself. The event structure displays two default events, namely the process of shouting and the resulting state. These events are temporally ordered and is headed by the state (e₂) event. The formal role in the qualia structure represents the act of shouting. The deverbative noun **umkhwazo** can appear as a head in a NP taking a descriptive possessive realized as a cognate noun.

Class 9

Prefix: **in-**

Suffix: **-i**

inkwazi (person who is an expert in calling / shouting)

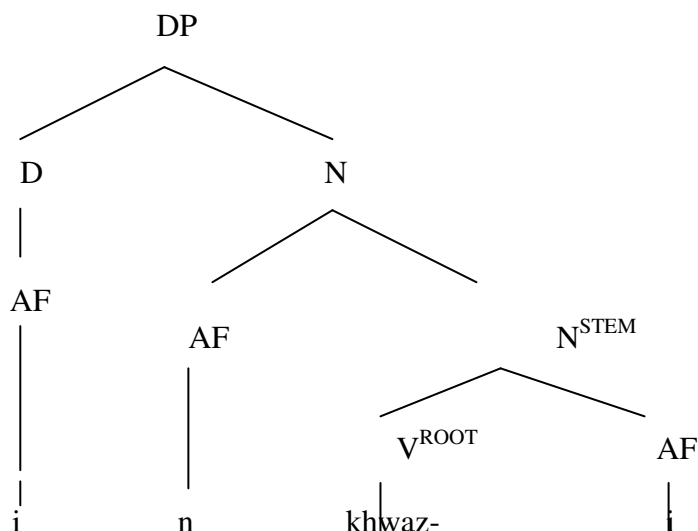

Nominalisation in class 9

inkwazi (person who is an expert in calling / shouting)

6. Inkwazi yangxolisa abafundi.
(The person who is an expert in calling shouted at the students)

inkwazi	
ARGSTR	= ARG 1 = x : human D - ARG 1 = y: animate
EVSTR	= D - E 1 = e ₁ : process D - E 2 = e ₂ : state Restr = Temporally ordered Head = e ₂
QUALIA	= FORMAL = khwaza _result (e _r , x, y) AGENTIVE = -khwaza _act_expert (e ₁ , x)

Hierarchy of semantic concepts

Call - Expert - Actor – Human

The lexical semantic representation of the deverbative noun **inkwazi** in (6) above, can be explained in a similar way to the representation of **umkhwazi** in (2) above. The only difference relates to the agentive quale which in addition has the feature [expert] to the notion of shouting.

Class 9

Prefix: **in-**

Suffix: **-o**

inkwazo (an act of calling / shouting)

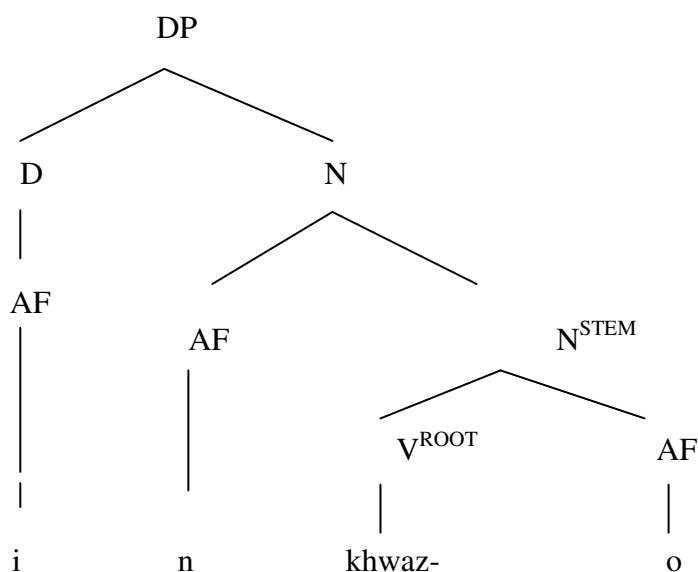

Nominalisation in class 9

inkwazo (an act of calling / shouting)

7. Inkwazo yomfundisi yawiwa libandla.

(The shouting of the reverend was heard by the congregation).

inkwazo	
ARGSTR	= ARG 1 = x : human D - ARG 1 = y : animate
EVSTR	= D - E 1 = e ₁ : process D - E 2 = e ₂ : state Restr = Temporally ordered Head = e ₂
QUALIA	= FORMAL = (e _r , x, y) AGENTIVE = -khwaza _ Result (e ₁ , x)

Hierarchy of semantic concepts

Shout - Act - Result

The lexical semantic representation of the deverbative noun **inkwazo** in (7) above, can be explained in a similar way to the representation of **umkhwazo** in (5) above. The only difference relates to the agentive quale which in addition has the feature [Result] to the notion of shouting. The deverbative **inkwazo** in (7) above, refers to an individual level nominal which is defined with respect to a particular event.

Class 11

Prefix: **u(lu-)**

Suffix: **-o**

ukhwazo (shouting)

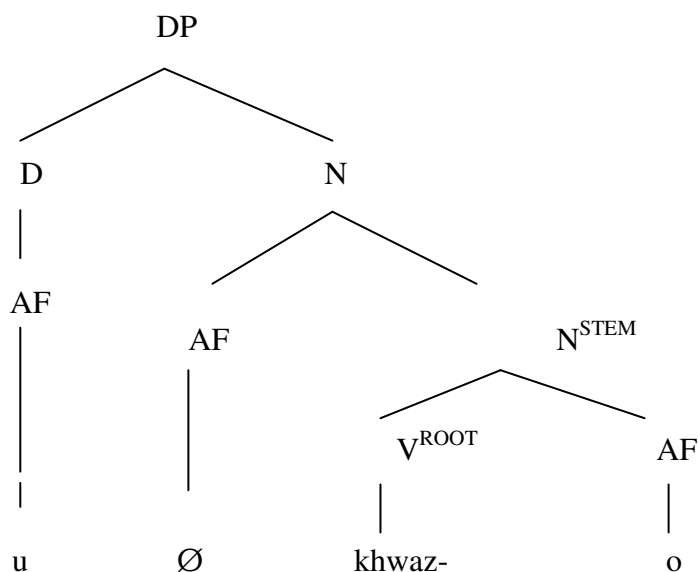

Nominalisation in class 11

ukhwazo (shouting)

8. Ukhwazo lwabantu loyikisa amasela.
(The shouting of the people frightened the thieves).

ukhwazo	
ARGSTR	= ARG 1 = e : r D - ARG 1 = y : inanimate
EVSTR	= D - E 1 = e ₁ : process D - E 2 = e ₂ : state Restr = Temporally ordered Head = e ₂
QUALIA	= FORMAL = khwaza _result(e _r , x, y) AGENTIVE = -khwaza _act [Event] (e ₁ , x)

Hierarchy of semantic concepts

Shout - Process - Result - Event

The lexical semantic representation of the deverbative **-ukhwazo** in (8) above has an explanation similar to that in (7) above. The distinguishing difference relates to the agentive quale, where in (8), the agentive quale is specified for the feature [Event] which is absent in (7).

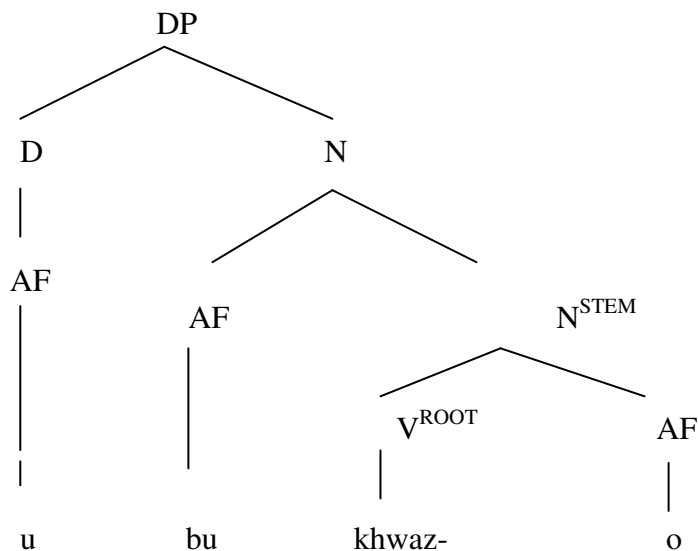
Class 14Prefix: **ubu**Suffix: **-o****ubukhwazo** (quality of shouting)**Nominalisation in class 14****ubukhwazo** (quality of shouting)

9. Ubukhwazo bengcibi baviwa ngakwenkwe.
(The quality shouting of initiate's surgeon was heard by the boys).

ubukhwazo

ARGSTR = ARG 1 = x : human

D - ARG 1 = animate

EVSTR = D - E 1 = e₁ : processD - E 2 = e₂ : state

Restr = Temporally ordered

Head = e₂QUALIA = FORMAL = **khwaza**_ result (e₁, x, y)AGENTIVE = **-khwaza** _ act _ Quality (e₁, x)

Hierarchy of semantic concepts

Shout - Process - Quality

The lexical semantic representation of **–ubukhwazo** above displays two arguments in its argument structure. One of these arguments is a default arguments (i.e. animate). The other argument is the reference (r) of the event of quality shouting by itself. The event structure displays two default events, namely the process of shouting and the resulting state. These events are temporally ordered and is headed by the state (e₂) event. The formal role in the qualia structure represents the quality act of shouting.

Observation regarding the analysis of transitive verbs of communication:

The above analysis of deverbatives derived from transitive verbs of communication demonstrate that:

A. These verbs take an animate argument, the event is a process and one formal quale occurs in terms of which the animate argument is in a process of swallowing (e₁, x).

B. Nominalisation in class 1

The analysis reflects the analysis of the transitive verb **khwaza** in (1) above except that the argument is only human, hence the semantic concepts refers to this feature, that is, [human]. The presence of the prefix **um-** and the suffix **–i** compositionally realize an interpretation of human for **umkhwazi**.

C. Nominalisation in class 7

The class 7 deverbative noun **isikhwazi** with the suffix **–i** denotes the feature human. The analysis of class 7 **isikhwazi** in (3) above, is similar to that of class 1 nominalisation in (2). The only difference relates to the agentive quale which displays the feature [intensive] introduced by the prefix **isi-** in class 7. The deverbative noun **isikhwazi** can appear as a head in a NP taking a descriptive possessive realized as a cognate noun. On the other hand, the deverbative **isikhwazo** refers to an [Instrument]for calling.

D. **Nominalisation in class 9**

The class 9 deverbative **inkwazi** in (6) above can be analysed in a similar way to class 1, the only difference relates to the agentive quale which displays the feature [expert] introduced by the prefix **-in** in class 9. On the other hand, the deverbative **inkwazo** can be analysed in a similar way to class 3 in (5), the only difference relates to the agentive quale which displays the feature [Result] introduced by the prefix **-in** in class 9, which is absent in class 3.

E. **Nominalisation in class 3**

The argument **umkhwazo** in class 3 in (5) above, refers to the process of shouting. The argument is shown in the formal quale (x) to refer to the way of shouting. In addition the feature [Manner] appears in the agentive quale.

F. **Nominalisation in class 11**

The argument **ukhwazo** in class 11 can be analysed in a similar way to (5) above. The only difference relates to the agentive quale which demonstrates the feature [Event] introduced by the prefix **u(lu-)**. In class 11 the deverbative noun **ukhwazo**, refers to an individual level nominal which is defined to a particular event.

G. **Nominalisation in class 14**

The argument **ubukhwazo** in class 14 can be analysed in a similar way to class 11 in (8) above. The only difference relates to the agentive quale which exhibits the feature [Quality] introduced by the prefix **ubu**. In class 14 the deverbative noun **ubukhwazo** refers to the stage level nominal which is defined to a particular event.

The pattern that seem to emerge from transitive communication verbs is that these verbs can be analysed in a similar way. These deverbatives are mostly specified for all classes of nouns with the exception of the noun class 5, which is absent in these derived nominals. Most deverbative nouns derived from class 9 denote an (expert) person where the nominal suffix is **-i**, however, where the nominal suffix is **-o**, a result interpretation is exhibited, as can be illustrated in the lexical semantic representation of **ingxelo** (report) below:

ingxelo	
ARGSTR	= ARG 1 = e : r D - ARG 1 = X : phys. object)
EVSTR	= D - E 1 = e ₁ : process D - E 2 = e ₂ : state Restr = Temporally ordered Head = e ₂
QUALIA	= FORMAL = (e _r , x, y) AGENTIVE = -xela_ Result (e ₁ , x)

In summary, the examples of deverbatives derived from transitive communication verbs demonstrate that these deverbatives are mostly prevalent in class 1, class 7, class 11 and class 14. The deverbatives in class 1 and class 7 denote count nouns where the nominal suffix is **-i**. In class 7, the deverbative **isikhwazo** denotes instrument where the nominal suffix is **-o**. Only the deverbative in class 7, **isifundo**, denotes results where the nominal suffix is **-o**. The deverbative in class 7, **isicelo**, is the only deverbative denoting action where the nominal suffix is **-o**. The deverbative in class 11 denote event where the nominal suffix is **-o**. Only the deverbative in class 9, **imbuzo**, denotes event where the nominal suffix is **-o**.

The deverbatives **uthetho** and **uchazo** in class 11 denote result where the nominal suffix is **-o**. The deverbatives in class 9 denote results where the nominal suffix is **-o** whereas only two deverbatives **intloli** and **inkwazi** denote humans where the nominal suffix is **-i**. Only the deverbative in class 9, **inkwazo**, denotes action where the nominal suffix is **-o**. The deverbatives in class 14 denote quality where the nominal suffix is **-o** or **-i**. The deverbatives denoting humans where the nominal suffix is **-i** can readily be associated with corresponding plural nouns, however, the deverbatives in class 9 which have other semantic features do not readily take a corresponding plural form, as can be shown with the uncharacteristic deverbatives ***iintlaselelo** and ***iimbeko**, respectively. It is evident that the set of lexical semantic representations of the range of nominals derived from the transitive communication verbs in sub-section 4.3.8 of chapter 4 can be analysed in terms of a similar lexical semantic representations presented in sub-section 5.3.8 of chapter 5 as is demonstrated in the analysis of the communication verb **khwaza** in sub-section 5.3.8 above.

5.3.9 Put verbs with a locative argument

Levin (1993) described these verb classes in sub-section 4.3.9 of chapter 4. In section 4.3 sub-section 4.3.9 the transitive put verbs with a locative argument were analysed in terms of their deverbatives in noun classes 1, 3, 7, 9, 11 and 14. In the following section 5.3 sub-section 5.3.9 the deverbatives from the verb **tshayela** are examined in terms of their use. The various deverbatives derived from the transitive put verb **tshayela** demonstrate a semantic type such as Person, Event/ Manner of event, Action/Result, Instrument and Quality as specified in sub-section 5.3.9 of chapter 5.

Nominalisation from – tshayela (sweep)

The verb **tshayela** (sweep)

1. Intombazana itshayela endlwini.
(The girl is sweeping in the house).

-tshayela	
ARGSTR	= ARG 1 = x : human D - ARG 1 = y : location
EVSTR	= E 1 = e ₁ : process E 2 = e ₂ : state Restr(ucturing) = Temporally ordered Head = e ₂
QUALIA	= FORMAL = X AGENTIVE = -tshayela _ act (e ₁ , x, y)

Hierarchy of semantic concepts

Sweep - Act

The lexical semantic representation of the put verb **-tshayela** can be explained as displaying two arguments in its argument structure, one argument is the physical object denoting the entity performing the process, and the other argument is the default argument (i.e. the location where (to) the sweeping is taking place). The event structure shows that the verb expresses a process. The qualia properties display the formal quale, which denotes the identity of the

physical object (X) and the agentive quale which denotes the act (process) of sweeping (e_1) of a physical object (X) in a certain location (y).

Class 1

Prefix: **um-**

Suffix: **-i**

umtshayeli (person who sweeps)

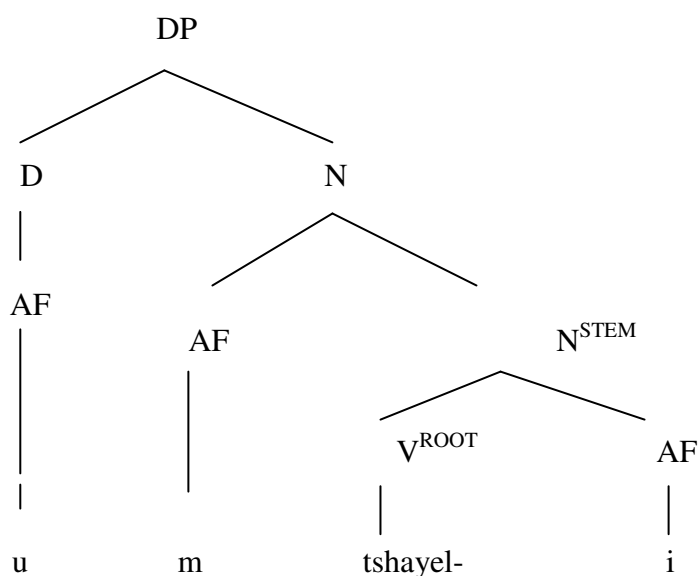

Nominalisation in class 1

umtshayeli (person who sweeps)

2. Umtshayeli walala egumbini.
(The sweeper slept in the room).

-umtshayeli

ARGSTR = ARG 1 = x : human

D - ARG 1 = y : location

EVSTR = E 1 = e_1 : process

E 2 = e_2 : state

Restr(ucturing) = Temporally ordered

Head = e_2

QUALIA = FORMAL = X

AGENTIVE = **-tshayela** _ act (e_1 , x, y)

Hierarchy of semantic concepts

Sweep - Location - Motion - Human

The lexical semantic representation of the deverbative **umtshayeli** displays an argument structure containing two arguments. The one argument represents the person who is sweeping, and the other argument, a default argument, represents the location where the sweeping person is sleeping. The event structure exemplifies two default events, namely the process of sleeping, and the resulting state. These events are temporally ordered and the state event (e_2) occurs as the head of the event structure. The qualia structure displays the formal quale, which represents the state of sleeping of a human at a location. The agentive quale specifies the act (i.e process) of sleeping by an individual.

Class 7

Prefix: **isi-**

Suffix: **-i**

isitshayeli (person who frequently sweeps)

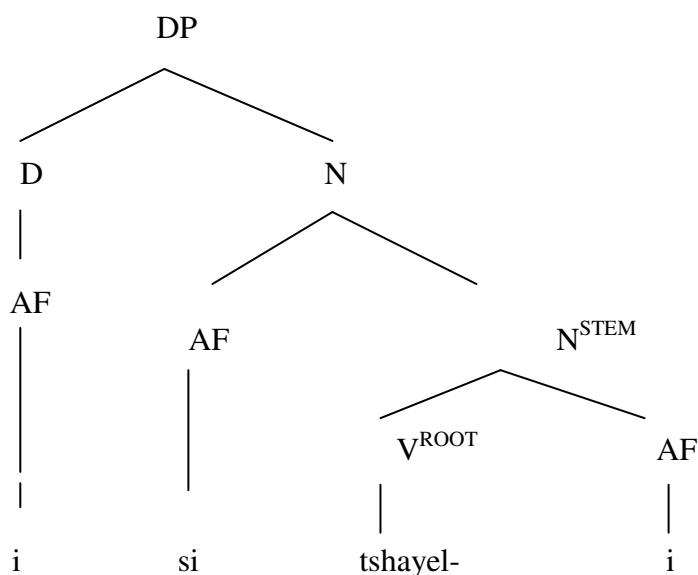

Nominalisation in class 7

isitshayeli (person who frequently sweeps)

3. Isitshayeli satshayela eholweni.
(The sweeper swept in the hall).

-isitshayeli	
ARGSTR	= ARG 1 = x : human D – ARG 1 = y : location
EVSTR	= E 1 = e ₁ : process E 2 = e ₂ : state Restr(ucturing) = Temporally ordered Head = e ₂
QUALIA	= FORMAL = X AGENTIVE = -tshayela _ act_intensive (e ₁ , x)

Hierarchy of semantic concepts

Sweep - Location - Intensive - Motion - Human

The explanation of the lexical semantic representation of **isitshayeli** is similar to that of **umtshayeli** in (2) above. The distinguishing difference is found in the formal quale which specifies the feature [Intensive] in (3), which is absent in (2).

Class 3

Prefix: **um-**

Suffix: **-o**

umtshayelo (sweeping instrument)

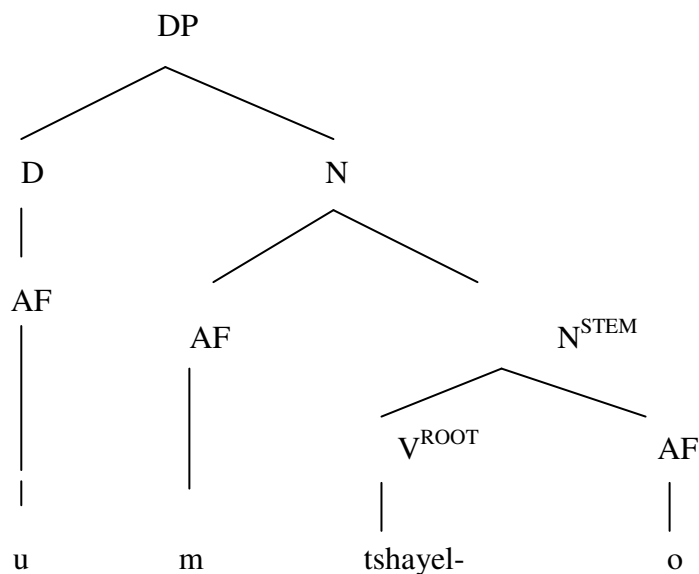

Nominalisation in class 3**umtshayelo** (sweeping instrument)

4. Umtshayelo waphuke esiqwini.
(The broom has broken in the middle).

-umtshayelo	
ARGSTR	= ARG 1 = x : phys(ical) object D – ARG 1 = y : location
EVSTR	= E 1 = e ₁ : process E 2 = e ₂ : state Restr = Temporally ordered Head = e ₂
QUALIA	= FORMAL = X AGENTIVE = -tshayela_act_instrument (e ₂ , x, y)

Hierarchy of semantic concepts

Sweep - Process - Instrument

The lexical semantic representation of the deverbative **umtshayelo** in (4) above can be explained in a similar way to (3) in regard to its argument structure, with the only differences specified in the argument structure where the default argument is locative. The first argument ARG1, displays the reference (r) of the event (e) of a sweeping instrument by itself. The event structure demonstrates the default argument which is a process of a sweeping instrument. The other difference specified in the formal quale relates to the presence of the feature [Instrument]. The deverbative **umtshayelo** in (4) above, refers to a stage level nominal which is defined with respect to a particular event.

Class 9Prefix: **in-**Suffix: **-o****intshayelo** (act of sweeping)

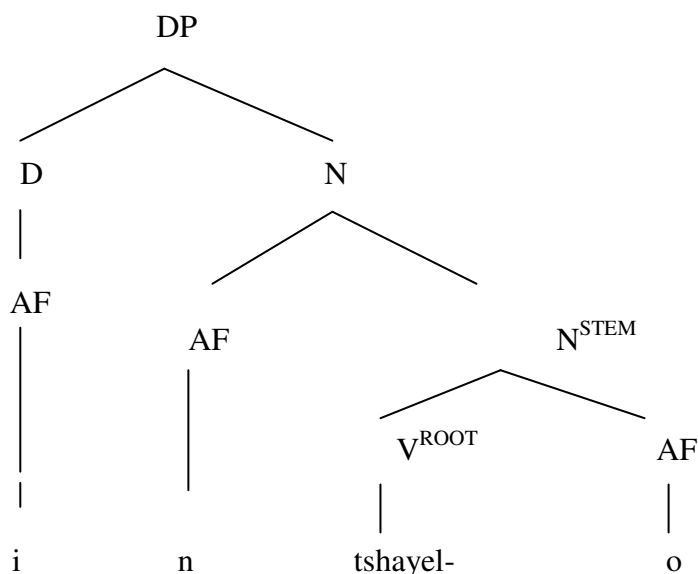

Nominalisation in class 9
intshayelo (act of sweeping)

4. Intshayelo yenziwa egumbini ngabafazi.
 (The sweeping was done in the room by the women).

intshayelo	
ARGSTR	= ARG 1 = e : r D – ARG 1 = X : phys. object) D – ARG 2 = y : location
EVSTR	= D - E 1 = e ₁ : process D - E 2 = e ₂ : state Restr = Temporally ordered Head = e ₂
QUALIA	= FORMAL = (e _r , x, y) AGENTIVE = -tshayela _ [Action] (e ₁ , x)_

The lexical semantic representation of **-intshayelo** above displays three arguments in its argument structure. Two of these arguments are default arguments. These are the physical object that performs the sweeping and the location at which the sweeping occurs. The other argument is the reference (r) of the event of sweeping by itself. The event structure displays two default events, namely the process of sweeping and the resulting state. These events are temporally ordered and is headed by the state (e₂) event. The formal role in the qualia structure represents the act of sweeping.

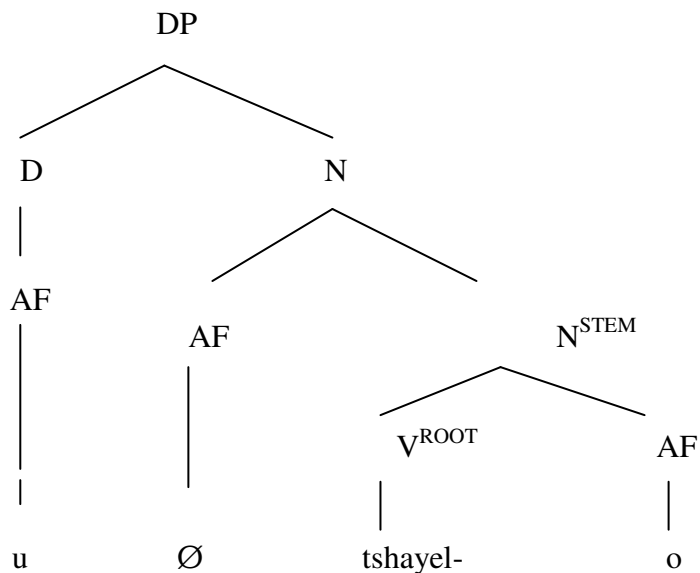
Class 11Prefix: **u(lu-)**Suffix: **-o****utshayelo** (sweeping)**Nominalisation in class 11****Utshayelo** (sweeping)

5. Utshayelo lwenziwa esikolweni ngabafundi
(The sweeping was done at school by the learners).

utshayelo

ARGSTR = ARG 1 = e : r

D – ARG 1 = X : phys. object)

D – ARG 2 = y : location

EVSTR = D - E 1 = e₁ : processD - E 2 = e₂ : state

Restr = Temporally ordered

Head = e₂QUALIA = FORMAL = (e_r, x, y)AGENTIVE = **-tshayela** _ [Event] (e₁, x)

Hierarchy of semantic concepts

Sweep - Location - Event - Motion - Human

The explanation of the lexical semantic representation of **utshayelo** is similar to that of **intshayelelo** in (4) above. The distinguishing difference is found in the formal quale which specifies the feature [Event] in (5), which is absent in (4).

Class 14

Prefix: **ubu-**

Suffix: **-o**

ubutshayelo (Quality of sweeping)

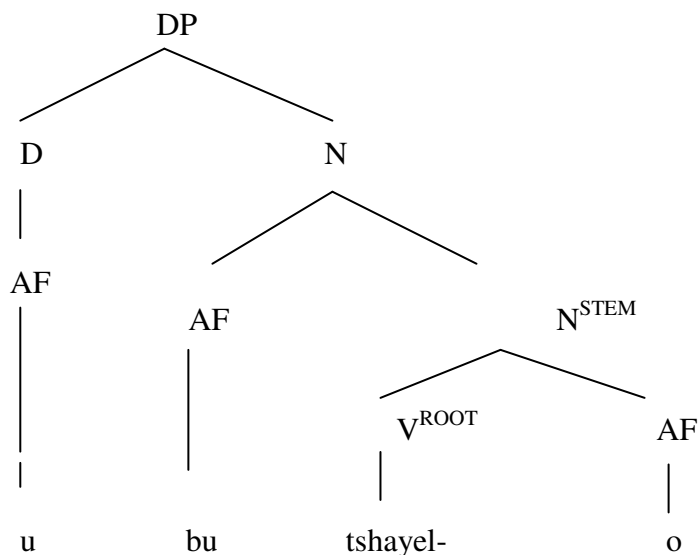

Nominalisation in class 14

ubutshayelo (quality of sweeping)

6. Ubutshayelo benziwa eholweni ngabahlali.
(The quality sweeping was done at school by the community)

ubutshayelo	
ARGSTR	= ARG 1 = e : r
	D – ARG 1 = x : human
	D – ARG 2 = y : location
EVSTR	= D - E 1 = e ₁ : process
	D - E 2 = e ₂ : state
	Restr = Temporally ordered
	Head = e ₂
QUALIA	= FORMAL = (e _r , x, y)
	AGENTIVE = -tshayela _ [Quality] (e ₁ , x)

Hierarchy of semantic concepts

Sweep - Process - Quality

The explanation of the lexical semantic representation of **ubutshayelo** is similar to that of **ushayelelo** in (5) above. The distinguishing difference is found in the formal quale which specifies the feature [Quality] in (6), which is absent in (5).

Observation regarding the analysis of transitive put verbs with a locative argument:

The above analysis of deverbatives derived from transitive put verbs with a locative argument demonstrate that:

- A. The transitive put verbs with a locative argument verbs take an animate argument, the event is a process and one formal quale occurs in terms of which the animate argument is in a process of sweeping (e₁, x).
- B. **Nominalisation in class 1**

The analysis reflects the analysis of the transitive verb **tshayela** in (1) above except that the argument is only human, hence the semantic concepts refers to this feature, that is, [human]. The presence of the prefix **um-** and the suffix **-i** compositionally realize an interpretation of human for **umtshayeli**.

C. **Nominalisation in class 7**

The class 7 deverbative noun **isitshayeli** with the suffix **-i** denotes the feature human. The analysis of class 7 **isitshayeli** in (3) above, is similar to that of class 1 nominalisation in (2). The only difference relates to the agentive quale which displays the feature [intensive] introduced by the prefix **isi-** in class 7. The deverbative noun **isitshayeli** can appear as a head in a NP taking a descriptive possessive realized as a cognate noun

D. **Nominalisation in class 3**

The class 3 deverbative **umtshayelo** with the suffix **-o** denotes the feature inanimate. The analysis of class 3 deverbative is similar to that of class 1 nominalisation the only difference relates to the agentive quale which displays the feature [Instrument] introduced by the prefix **um-** and the suffix **-o** in class 3.

E. **Nominalisation in class 9**

The class 9 deverbative **intshayelo** in (4) above can be analysed in a similar way to class 3, the only difference relates to the agentive quale which displays the feature [Action] introduced by the prefix **-in** in class 9.

F. **Nominalisation in class 11**

The argument **utshayelo** in class 11 can be analysed in a similar way to (4) above. The only difference relates to the agentive quale which demonstrates the feature [Event] introduced by the prefix **u(lu-)**. In class 11 the deverbative noun **utshayelo**, refers to an individual level nominal which is defined to a particular event.

G. **Nominalisation in class 14**

The argument **ubutshayelo** in class 14 can be analysed in a similar way to class 11 in (5) above. The only difference relates to the agentive quale which exhibits the feature [Quality] introduced by the prefix **ubu**. In class 14 the deverbative noun **ubutshayelo** refers to the stage level nominal which is defined to a particular event.

The other transitive put verbs with a locative argument can be analysed in a similar way. These deverbatives are mostly specified for all classes of nouns with the exception of the deverbatives derived from the verb **galela** and **faka** respectively. Most deverbative nouns derived from class 1 and class 7 denote a person where the nominal suffix is **-i**. In situations where the nominal suffix is **-o** a different interpretation can be exhibited as can be illustrated in the lexical semantic representation of **isithwalo** (cloth) below:

isithwalo	
ARGSTR	= ARG 1 = e : r D - ARG 1 = X : phys. object)
EVSTR	= D - E 1 = e ₁ : process D - E 2 = e ₂ : state Restr = Temporally ordered Head = e ₂
QUALIA	= FORMAL = (e _r , x, y) AGENTIVE = thwala_act_[artefact]] (e ₁ , x)

In summary, the examples of deverbatives derived from transitive put verbs with a locative argument demonstrate that these deverbatives are mostly prevalent in classes 1 and class 11 and to a lesser degree in class 3 and class 7 as has been shown in the lexical schematic representation in sub-section 4.3.9 of chapter 4. The deverbatives in class 1 and class 9 denote count nouns where the nominal suffix is **-i**. In class 11, the deverbatives denote event where the nominal suffix is **-o**. Only the deverbative **umqabo** in class 3 denotes event. There are only two deverbatives **umxhomo** and **umlayisho** in class 3 denoting manner of event where the nominal suffix is **-o**.

There are only two deverbatives in class 3, **umbeko** and **umthwalo**, and one deverbative in class 7, **isibeko**, denoting results where where the nominal suffix is **-o**. Only one deverbative in class 3, **umtshayelo**, and the deverbatives in class 7, **isitshizi** and **isilayisho**, denote instrument where the nominal suffix is **-o** or **-i**, respectively. There is only one deverbative in class 7, **isithwalo**, denoting artefact where the nominal suffix is **-o**. The deverbatives in class

14 denote quality where the nominal suffix is **-o**. Only one deverbative in class 14, **ubuqaba**, denotes state where the nominal suffix is **-a**.

The deverbatives denoting count nouns where the nominal suffix is **-i** can readily be associated with corresponding plural nouns, however, the deverbatives in class 9 which have other semantic features are not readily associated with a corresponding plural form, as can be illustrated with the uncharacteristic deverbatives ***iintshayelo** and ***iinkxomo**, respectively. It is evident that the set of lexical semantic representations of the range of nominals derived from the transitive put verbs with a locative argument in sub-section 4.3.9 of chapter 4 can be analysed in terms of a similar lexical semantic representations presented in sub-section 5.3.9 of chapter 5 as is demonstrated in the analysis of the put verb **tshayela** in sub-section 5.3.9 above.

5.3.10 Remove verbs with a locative argument

Levin (1993) described these verb classes in sub-section 4.3.10 of chapter 4. In section 4.3 sub-section 4.3.10 the transitive remove verbs with a locative argument were analysed in terms of their deverbatives in noun classes 1, 3, 7, 9, 11 and 14. In the following section 5.3 sub-section 5.3.1 the deverbatives from the verb **goba** are examined in terms of their use. The various deverbatives derived from the transitive remove verb **-xhwila** with a locative argument demonstrate a semantic type such as Person, Event/ Manner of event, Action/Result and Quality as specified in sub-section 5.3.10 of chapter 5.

Nominalisation from – **xhwila** (grab, snatch)

The verb **xhwila** (grab, snatch)

2. Inkawu ixhwile isonka endodeni.
(The monkey snatched bread from a man).

-xhwila	
ARGSTR	= ARG 1 = animate D- ARG 1= x : phys(ical) obj(ect) D - ARG 1 = y : location
EVSTR	= E 1 = e ₁ : process E 2 = e ₂ : state Restr(ucturing) = Temporally ordered Head = e ₂
QUALIA	= FORMAL = X AGENTIVE = -xhwila _ act (e ₁ , x, y)

Hierarchy of semantic concepts

Snatch - Act

The lexical semantic representation of the remove verb **-xhwila** can be explained as displaying three arguments in its argument structure (ARGSTR), one argument is the animate object denoting the entity performing the process, and the other two arguments are the default arguments (i.e. the location where (to) the snatching is taking place and the physical object subjected to the snatching). The event structure (EVSTR) shows that the verb expresses a process. The qualia properties display the formal quale, which denotes the identity of the physical object (X) and the agentive quale which denotes the act (process) of snatching (e₁) of a physical object (X) in a certain location (y).

Class 1

Prefix: **um-**

Suffix: **-i**

umxhwili (person who snatches (something))

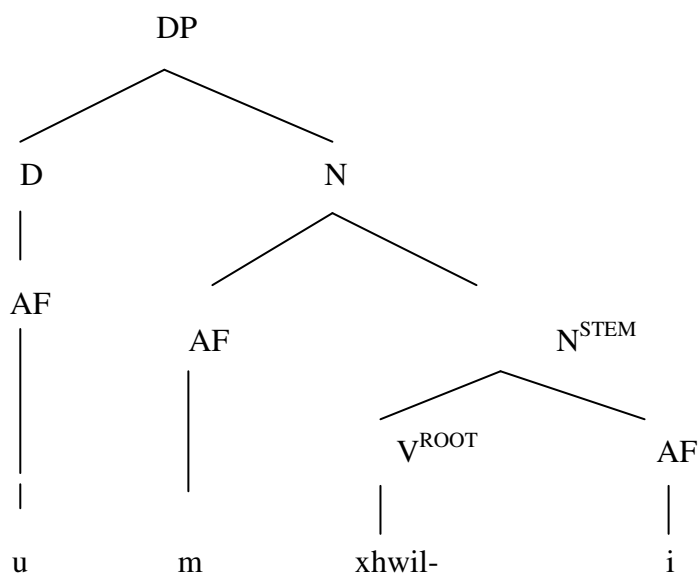

Nominalisation in class 1

umxhwili (person who snatches (something))

2. Umxhwili wabanjwa esitalatweni.
(The snatcher was arrested on the street).

-umxhwili	
ARGSTR	= ARG 1 = x : human D - ARG 1 = y : location
EVSTR	= E 1 = e ₁ : process E 2 = e ₂ : state Restr(ucturing) = Temporally ordered Head = e ₂
QUALIA	= FORMAL = X AGENTIVE = -xhwila _ act (e ₁ , x, y)

Hierarchy of semantic concepts

Snatch - Location - Motion - Human

The lexical semantic representation of the deverbative **umxhwili** displays an argument structure containing two arguments. The one argument represents the person who snatches purses, and the other argument, a default argument, represents the location where the snatching takes place. The event structure exemplifies two default events, namely the process

of snatching, and the resulting state. These events are temporally ordered and the state event (e_2) occurs as the head of the event structure. The qualia structure displays the formal quale, which represents the state of snatching of a human at a location. The agentive quale specifies the act (i.e process) of snatching by an individual.

Class 7

Prefix: **isi-**

Suffix: **-i**

isixhwili (person who frequently snatches)

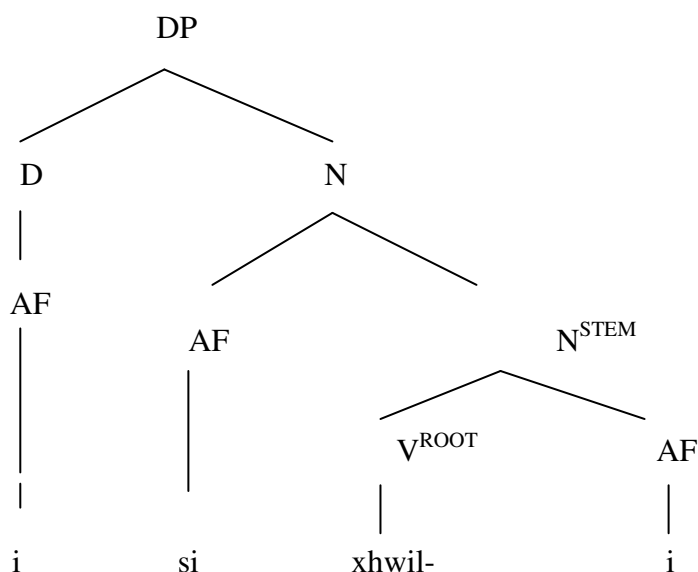

Nominalisation in class 7

isixhwili (person who frequently sweeps)

3. Isixhwili sendoda sabuyiselwa entolongweni.
(The snatching man was returned to prison).

-isixhwili	
ARGSTR	= ARG 1 = x : human D – ARG 1 = y : location
EVSTR	= E 1 = e_1 : process E 2 = e_2 : state Restr(ucturing) = Temporally ordered Head = e_2
QUALIA	= FORMAL = X AGENTIVE = -xhwila _ act_intensive (e_1 , x)

Hierarchy of semantic concepts

Snatch - Location - Intensive - Motion - Human

The explanation of the lexical semantic representation of **isixhwili** is similar to that of **umxhwili** in (2) above. The distinguishing difference is found in the formal quale which specifies the feature [Intensive] in (3), which is absent in (2).

Class 9

Prefix: **in-**

Suffix: **-i**

inkxwili (person who is an expert in snatching / grabbing)

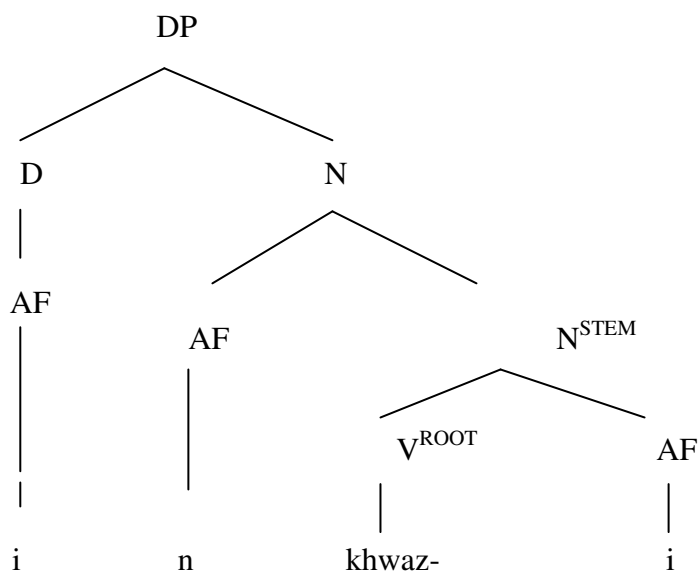

Nominalisation in class 9

inkxwili (person who is an expert in snatching / grabbing)

4. Inkxwili yabalekela ematyotyombeni.
(The person who is an expert in snatching ran into the squatter camp).

inkxwili	
ARGSTR	= ARG 1 = x : human D – ARG 1 = y: location
EVSTR	= D - E 1 = e ₁ : process D - E 2 = e ₂ : state Restr = Temporally ordered Head = e ₂
QUALIA	= FORMAL = xhwila _result (e _r , x, y) AGENTIVE = -xhwila _act_expert (e ₁ , x)

Hierarchy of semantic concepts

Snatch - Expert - Location - Actor – Human

The lexical semantic representation of the deverbative noun **inkxwili** in (4) above, can be explained in a similar way to the representation of **umxhwili** in (2) above. The only difference relates to the agentive quale which in addition has the feature [expert] to the notion of shouting.

Class 9

Prefix: **in-**

Suffix: **-o**

inkxwilo (an act of snatching / grabbing)

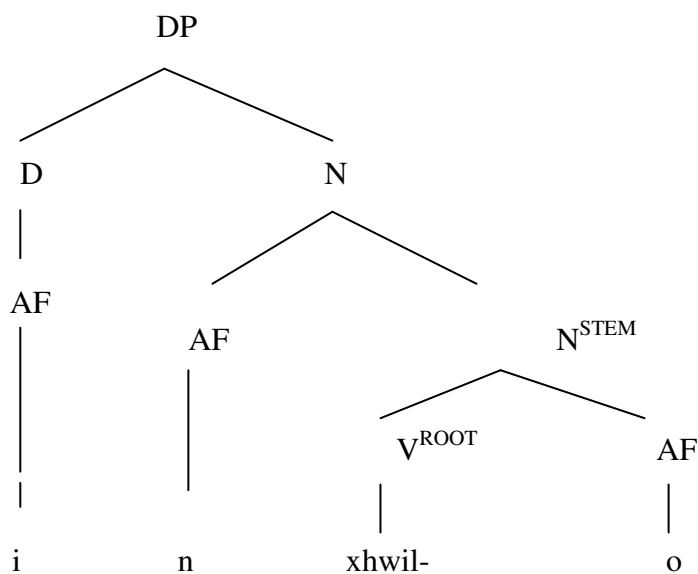

Nominalisation in class 9

inkwazo (an act of snatching / grabbing)

5. Inkxwilo mali yenzeka ebhankini.
(The snatching of money took place in the bank).

inkxwilo	
ARGSTR	= ARG 1 = e : r D - ARG 1 = y : location
EVSTR	= D - E 1 = e ₁ : process D - E 2 = e ₂ : state Restr = Temporally ordered Head = e ₂
QUALIA	= FORMAL = (e _r , x, y) AGENTIVE = -xhwila [Action] (e ₁ , x)

Hierarchy of semantic concepts

Snatch - Location - Action

The lexical semantic representation of the deverbative noun **inkxwilo** in (5) above has two arguments in its argument structure (ARGSTR). The first argument ARG1, displays the reference (r) of the event (e) of a snatching by itself, and the other argument is the default argument (i.e. the location where (to) the snatching is taking place). The event structure displays two default events, namely the process of snatching and the resulting state. These events are temporally ordered and is headed by the state (e₂) event. The formal role in the qualia structure represents the act of snatching. The deverbative **inkxwilo** in (5) above, refers to a stage level nominal which is defined with respect to a particular event.

Class 3

Prefix: **um-**

Suffix: **-o**

umxhwilo (way of (snatching))

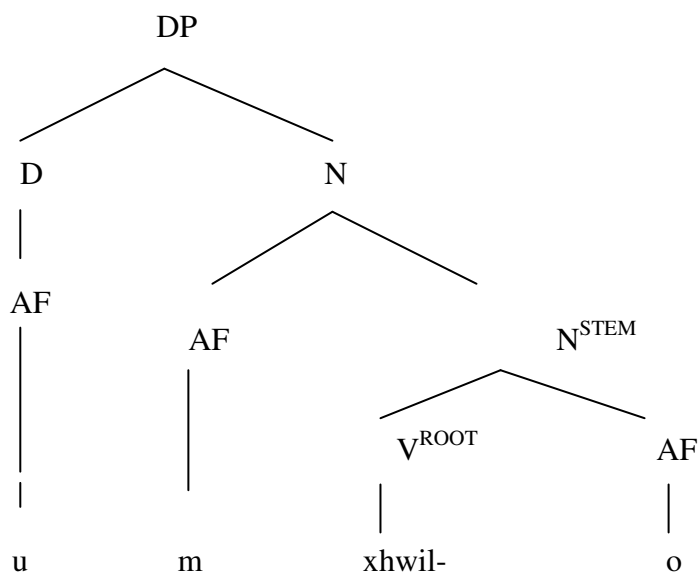

Nominalisation in class 3

umxhwilo (way of (snatching, grabbing))

6. Umxhwilo wemali wenzeke ebhulorweni.
(The snatching of the money occurred at the bridge).

umxhwilo	
ARGSTR	= ARG 1 = e : r D – ARG 1 = location
EVSTR	= D - E 1 = e ₁ : process D - E 2 = e ₂ : state Restr = Temporally ordered Head = e ₂
QUALIA	= FORMAL = (e _r , x, y) AGENTIVE = -xhwila _ act [Manner] (e ₁ , x)

Hierarchy of semantic concepts

Snatch - Process - Act - Manner

The explanation of the lexical semantic representation of **umxhwilo** is similar to that of **inkxwilo** in (5) above. The distinguishing difference is found in the formal quale which specifies the feature [Manner] in (6), which is absent in (5).

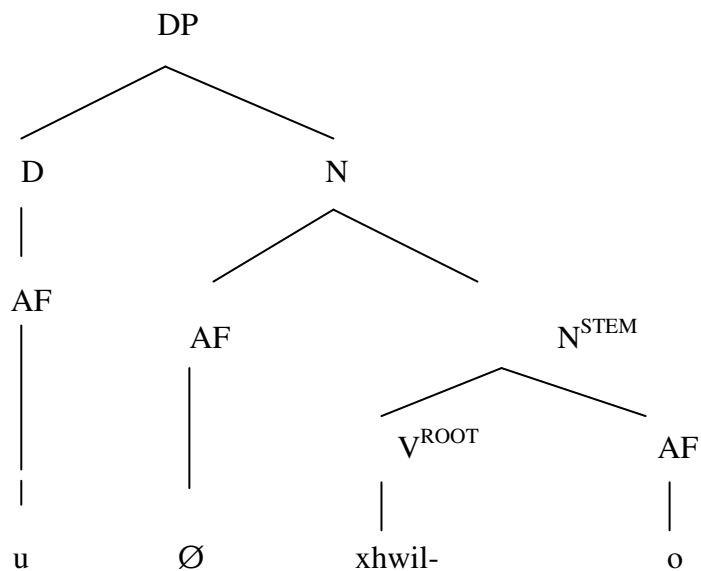
Class 11Prefix: **u(lu-)**Suffix: **-o****uxhwilo** (snatching / grabbing)**Nominalisation in class 11****uxhwilo** (snatching / hijacking / grabbing)

7. Uxhwilo lwemoto lwenzeka edolophini.
(The snatching of the car happened in town).

uxhwilo	
ARGSTR	= ARG 1 = e : r D - ARG 1 = y : location
EVSTR	= D - E 1 = e ₁ : process D - E 2 = e ₂ : state Restr = Temporally ordered Head = e ₂
QUALIA	= FORMAL = (e _r , x, y) AGENTIVE = -tshayela _ [Event] (e ₁ , x)

Hierarchy of semantic concepts

Snatch - Location - Event - Motion - Human

The explanation of the lexical semantic representation of **uxhwilo** is similar to that of **umxhwilo** in (6) above. The distinguishing difference is found in the formal quale which specifies the feature [Event] in (7), which is absent in (6).

Class 14

Prefix: **ubu-**

Suffix: **-o**

ubuxhwilo (Quality of snatching)

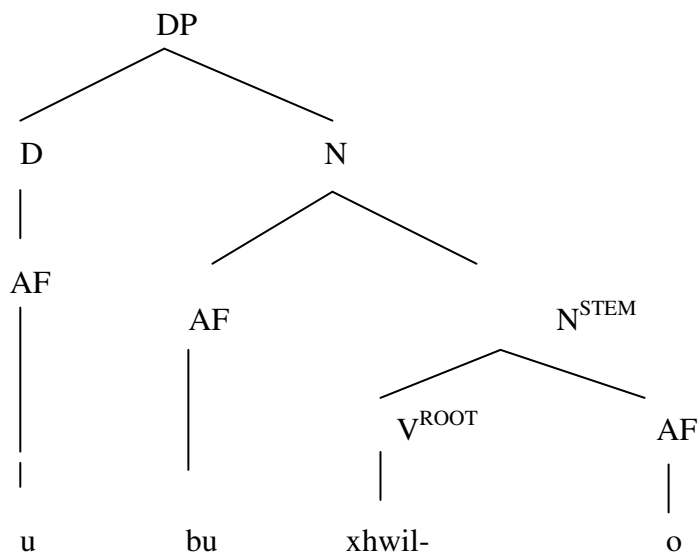

Nominalisation in class 14

ubuxhwilo (quality of snatching)

8. Ubuxhwilo bebhayisekile benzeka esitalatweni.
(The quality snatching of the bicycle occurred in the street).

ubuxhwilo	
ARGSTR	= ARG 1 = e : r D - ARG 1 = y : location
EVSTR	= D - E 1 = e ₁ : process D - E 2 = e ₂ : state Restr = Temporally ordered Head = e ₂
QUALIA	= FORMAL = (e _r , x, y) AGENTIVE = - xhwila _ [Quality] (e ₁ , x) _

Hierarchy of semantic concepts

Snatch - Process - Quality

The explanation of the lexical semantic representation of **ubuxhwilo** is similar to that of **uxhwilo** in (7) above. The distinguishing difference is found in the formal quale which specifies the feature [Quality] in (8), which is absent in (7).

Observation regarding the analysis of transitive remove verbs with a locative argument:

The above analysis of deverbatives derived from transitive remove verbs with a locative argument demonstrate that:

A. The transitive remove verbs with a locative argument verbs take an animate argument, the event is a process and one formal quale occurs in terms of which the animate argument is in a process of snatching (e₁, x).

B. Nominalisation in class 1

The analysis reflects the analysis of the transitive verb **xhwila** in (1) above except that the argument is only human, hence the semantic concepts refers to this feature, that is, [human]. The presence of the prefix **um-** and the suffix **-i** compositionally realize an interpretation of human for **umxhwili**.

C. Nominalisation in class 7

The class 7 deverbative noun **isixhwili** with the suffix **-i** denotes the feature human. The analysis of class 7 **isixhwili** in (3) above, is similar to that of class 1

nominalisation in (2). The only difference relates to the agentive quale which displays the feature [intensive] introduced by the prefix **isi-** in class 7. The deverbative noun **isixhwili** can appear as a head in a NP taking a descriptive possessive realized as a cognate noun

D. **Nominalisation in class 9**

The class 9 deverbative **inkxwili** in (4) above can be analysed in a similar way to class 7, the only difference relates to the agentive quale which displays the feature [expert] introduced by the prefix **-in** in class 9. On the other hand the deverbative **inkxwilo** has an agentive quale which displays the feature feature [Action] introduced by the suffix **-o** in class 9.

E. **Nominalisation in class 3**

The class 3 deverbative **umxhwilo** with the suffix **-o** denotes the feature inanimate. The analysis of class 3 deverbative is similar to that of **inkxwilo** in class 9 nominalisation, the only difference relates to the agentive quale which displays the feature [Manner] introduced by the prefix **um-** and the suffix **-o** in class 3.

F. **Nominalisation in class 11**

The argument **uxhwilo** in class 11 can be analysed in a similar way to (5) above. The only difference relates to the agentive quale which demonstrates the feature [Event] introduced by the prefix **u(lu-)**. In class 11 the deverbative noun **uxhwilo** , refers to an individual level nominal which is defined to a particular event.

G. **Nominalisation in class 14**

The argument **ubuxhwilo** in class 14 can be analysed in a similar way to class 11 in (7) above. The only difference relates to the agentive quale which exhibits the feature [Quality] introduced by the prefix **ubu**. In class 14 the deverbative noun **ubuxhwilo** refers to the stage level nominal which is defined to a particular event.

The transitive remove verbs with a locative argument can be analysed in a similar way, and that these deverbatives are mostly specified for all classes of nouns except

for class 5 deverbatives. Most deverbative nouns derived from class 1, class 7 and class 9 denote a person where the where the nominal suffix is **-i**. In situations where the nominal suffix is **-o**, particularly in class 9, a different interpretation can be exhibited as can be demonstrated in the lexical semantic representation of **inkxwitho** (plucking) below:

inkxwitho	
ARGSTR	= ARG 1 = e : r D - ARG 1 = X : phys. object)
EVSTR	= D - E 1 = e ₁ : process D - E 2 = e ₂ : state Restr = Temporally ordered Head = e ₂
QUALIA	= FORMAL = (e _r , x, y) AGENTIVE = xhwitha _[Action]] (e ₁ , x)

In summary, the examples of deverbatives derived from transitive remove verbs demonstrate that these deverbatives are mostly prevalent in class 1, class 7, class 9 and class 11. The deverbatives in class 1 and class 7 denote count nouns where the nominal suffix is **-i**. Only one deverbative in class 9, **ingxothi**, denotes count nouns where the nominal suffix is **-i**. The deverbatives in class 11 denote event where the nominal suffix is **-o**.

The deverbatives in class 3 denote manner of event where the nominal suffix is **-o**. In class 9, the deverbatives denote action results where the nominal suffix is **-o**. The deverbatives in class 14 denote quality where the nominal suffix is **-o**. The deverbatives denoting humans where the nominal suffix is **-i** can readily be associated with corresponding plural nouns, however, the deverbatives in class 9 which have other semantic features do not readily take a corresponding plural form, as can be illustrated with the irregular deverbatives ***iintatho** and **iinkxwilo**, respectively.

It is evident that the set of lexical semantic representations of the range of nominals derived from the transitive remove verbs with a locative argument in sub-section 4.3.10 of chapter 4 can be analysed in terms of a similar lexical semantic representations presented in sub-section

5.3.10 of chapter 5 as is demonstrated in the analysis of the remove verb **xhwila** in sub-section 5.3.10 above.

5.4 DITRANSITIVE VERBS

5.4.1 Change of possession verbs

Levin (1993) described these verb classes in sub-section 4.3.1 of chapter 4. In section 4.4 sub-section 4.4.1 the ditransitive change of possession verbs were analysed in terms of their deverbatives in noun classes 1, 3, 7, 9, 11 and 14. In the following section 5.4 sub-section 5.4.1 the deverbatives from the verb **boleka** are examined in terms of their use. The various deverbatives derived from the ditransitive change verb **boleka** demonstrate a semantic type such as Person, Event/ Manner of event, Action/Result and Quality as specified in sub-section 5.4.1 of chapter 5.

Nominalisation from – **boleka** (borrow, lend)

The verb **boleka** (borrow, lend)

1. Ibhanki iboleke indoda imali.
(The bank borrowed the man money).

-boleka	
ARGSTR	= ARG 1 = e : r D- ARG 1= x : human D - ARG 2 = y : phys(ical) obj(ect)
EVSTR	= E 1 = e ₁ : process E 2 = e ₂ : state Restr(ucturing) = Temporally ordered Head = e ₂
QUALIA	= FORMAL = X AGENTIVE = -boleka _ act (e ₁ , x, y)

Hierarchy of semantic concepts

Borrow – Process - Act

The lexical semantic representation of the remove verb **-xhwila** can be explained as displaying three arguments in its argument structure. The first argument ARG1, displays the reference (r) of the event (e) of borrowing by itself, and the other two arguments are the default arguments (i.e. the physical object subjected to the borrowing) and the individual entity (human) being borrowed the money. The event structure shows that the verb expresses a process. The qualia properties display the formal quale, which denotes the identity of the physical object (X) and the agentive quale which denotes the act (process) of borrowing (e₁) of a physical object (X) by a certain individual (x).

Class 1

Prefix: **um-**

Suffix: **-i**

umboleki (person who borrows (something))

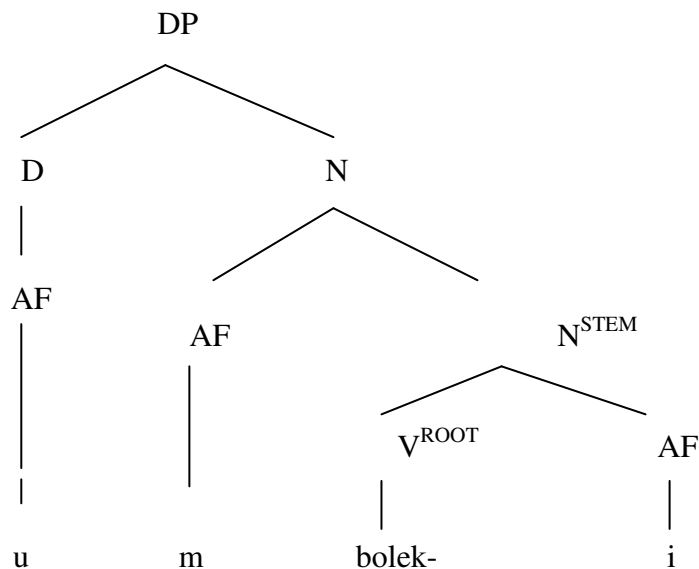

Nominalisation in class 1

umboleki (person who borrows (something))

2. Umboleki upha abantwana inyama.
(The borrower gives the children meat).

-umboleki	
ARGSTR	= ARG 1 = e : r D - ARG 1 x : human D - ARG 2 = y : phys(ical obj(ect))
EVSTR	= E 1 = e ₁ : process E 2 = e ₂ : state Restr(ucturing) = Temporally ordered Head = e ₂
QUALIA	= FORMAL = X AGENTIVE = -boleka _ act (e ₁ , x, y)

Hierarchy of semantic concepts

Snatch - Location - Motion - Human

The lexical semantic representation of the deverbative **umboleki** displays an argument structure containing three arguments. The one argument is the human who borrows (something), and the other arguments are the default arguments (i.e. the animate). The presence of the prefix **um** and the suffix **-i** compositionally realise an interpretation of human for **umboleki**. The other arguments, default arguments, represent the physical object being given away and the other the individual (human) receiving (something). The event structure exemplifies two default events, namely the process of borrowing, and the resulting state. These events are temporally ordered and the state event (e₂) occurs as the head of the event structure. The qualia structure displays the formal quale, which represents the state of giving. The agentive quale specifies the act (i.e. process) of giving by an individual.

Class 7

Prefix: **isi-**

Suffix: **-i**

isiboleki (person who frequently borrows)

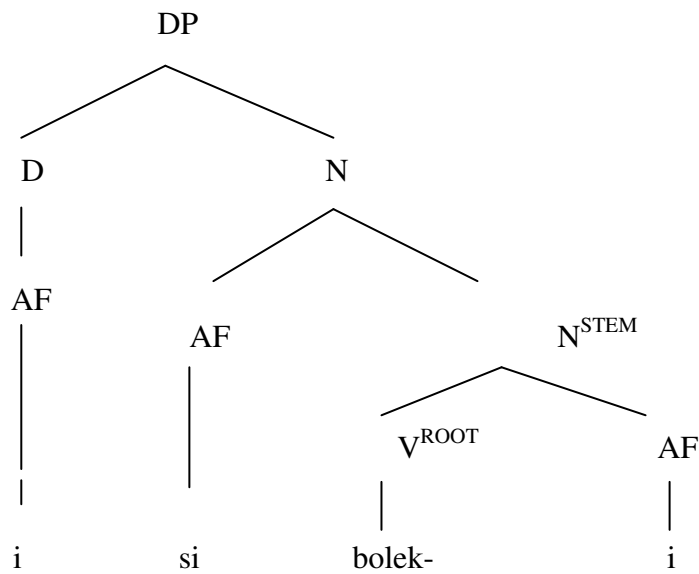

Nominalisation in class 7

isiboleki (person who frequently borrows)

3. Isiboleki sanikainja ukutya.
(The borrowing person gave the dog food).

-isiboleki	
ARGSTR	= ARG 1 = e : r D- ARG 1 x : animate D – ARG 2 = y : food
EVSTR	= E 1 = e ₁ : process E 2 = e ₂ : state Restr(ucturing) = Temporally ordered Head = e ₂
QUALIA	= FORMAL = X AGENTIVE = -boleka _ act_intensive (e ₁ , x)

Hierarchy of semantic concepts

Borrow - Intensive - Motion - Human

The explanation of the lexical semantic representation of **isiboleki** is similar to that of **umboleki** in (2) above. The distinguishing difference is found in the formal quale which specifies the feature [Intensive] in (3), which is absent in (2).

Nominalisation in class 9

imboleki (person who is an expert in borrowing)

4. Imboleki ithenge icuba evenkileni.

(The person who is an expert in borrowing bought tobacco in the shop).

-imboleki	
ARGSTR	= ARG 1 = e : r D- ARG 1 x : phys(ical obj(ect)) D – ARG 2 = y : location
EVSTR	= E 1 = e ₁ : process E 2 = e ₂ : state Restr(ucturing) = Temporally ordered Head = e ₂
QUALIA	= FORMAL = X AGENTIVE = -boleka _ act_expert (e ₁ , x)

Hierarchy of semantic concepts

Borrow - Expert - Location - Actor – Human

The lexical semantic representation of the deverbative **imboleki** displays an argument structure containing three arguments. the one argument is the human who is an expert in borrowing (something), and the other arguments are the default srguments (i.e. the physical object being bought and the other is the location where the physical object was bought). The presence of the prefix **im** and the suffix **-i** compositionally realise an interpretation of human for **imboleki**. The event structure shows that the verb expresses a process. The qualia properties display the formal quale, which denotes the identity of the physical object (X) and

the agentive quale which denotes the act (process) of buying (e_1) of a physical object (X) in a certain location (y).

Class 9

Prefix: **in-**

Suffix: **-o**

imboleko (an act of borrowing)

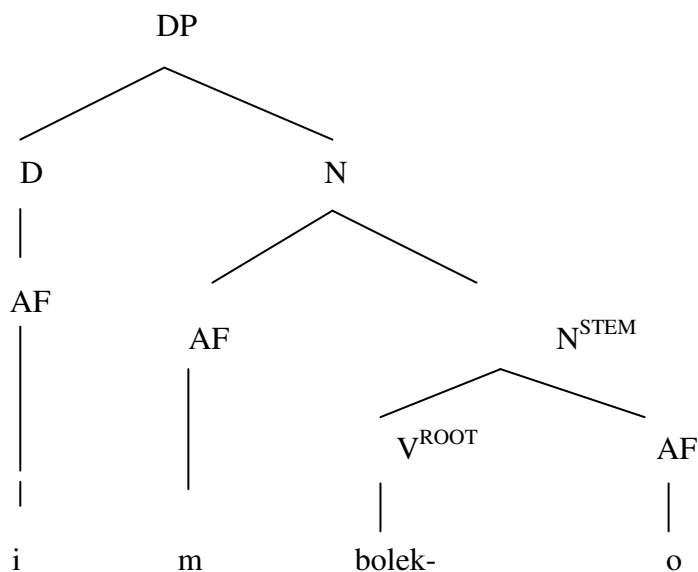

Nominalisation in class 9

imboleko (an act of borrowing)

5. Imboleko yemali yenzeka ebhankini.
(The borrowing of the money took place in the bank).

imboleko	
ARGSTR	= ARG 1 = $e : r$ D – ARG 1 = y : location
EVSTR	= D - E 1 = e_1 : process D - E 2 = e_2 : state Restr = Temporally ordered Head = e_2
QUALIA	= FORMAL = (e_r, x, y) AGENTIVE = -boleka_ [Action] (e_1, x)

Hierarchy of semantic concepts

Borrow - Location - Action

The lexical semantic representation of **imboleko** in (5) above has two arguments in its argument structure (ARGSTR). The first argument ARG1, displays the reference (r) of the event (e) of a borrowing by itself, and the other argument is the default argument (i.e. the location where (to) the borrowing is taking place). The event structure displays two default events, namely the process of borrowing and the resulting state. These events are temporally ordered and is headed by the state (e₂) event. The formal role in the qualia structure represents the act of borrowing. The deverbative **imboleko** in (5) above, refers to a stage level nominal which is defined with respect to a particular event.

Class 3

Prefix: **um-**

Suffix: **-o**

umboleko (way of (borrowing))

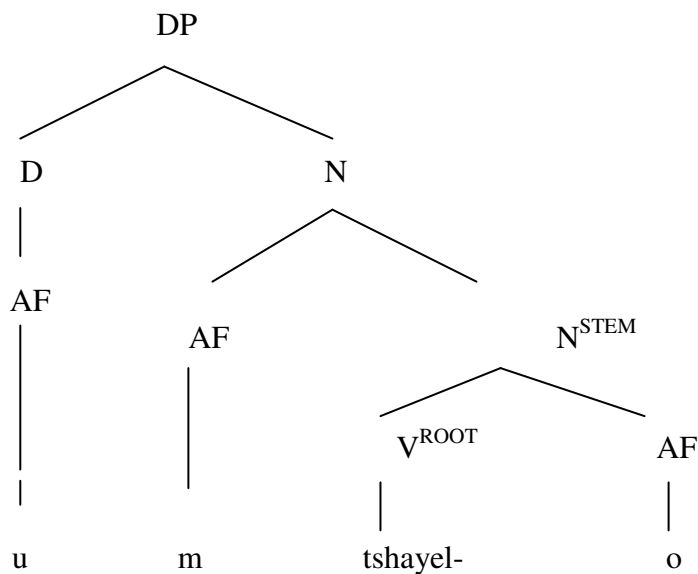

Nominalisation in class 3

umboleko (way of (borrowing, lending))

6. Umboleko wemali wenzeka emsebenzini.
(The borrowing of the money occurs at work).

umboleko	
ARGSTR	= ARG 1 = e : r D - ARG 1 = location
EVSTR	= D - E 1 = e ₁ : process D - E 2 = e ₂ : state Restr = Temporally ordered Head = e ₂
QUALIA	= FORMAL = (e _r , x, y) AGENTIVE = -boleka _ act [Manner] (e ₁ , x)

Hierarchy of semantic concepts

Borrow - Process - Act - Manner

The explanation of the lexical semantic representation of **umboleko** in (6) above has two arguments in its argument structure (ARGSTR). The first argument ARG1, displays the reference (r) of the event (e) of a borrowing by itself, and the other argument is the default argument (i.e. the location where (to) the borrowing is taking place). The event structure displays two default events, namely the process of borrowing and the resulting state. These events are temporally ordered and is headed by the state (e₂) event. The formal role in the qualia structure represents the act of borrowing. The deverbative **umboleko** in (6) above, refers to a stage level nominal which is defined with respect to a particular event.

Class 11

Prefix: **u(lu-)**

Suffix: **-o**

umboleko (borrowing)

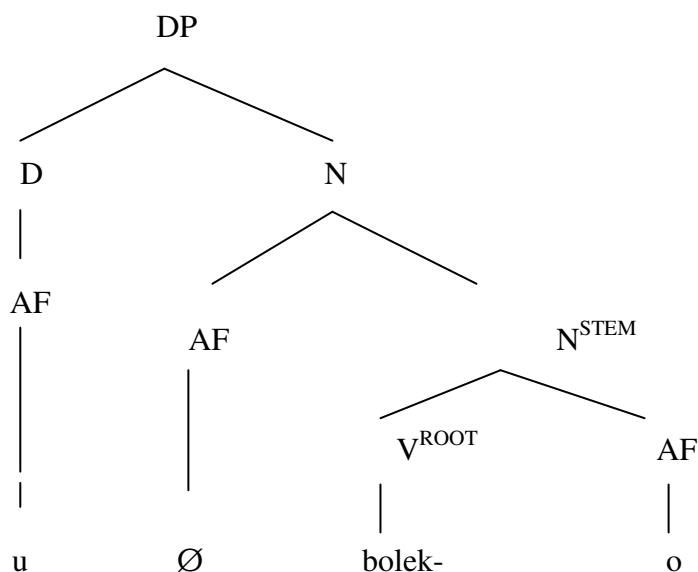

Nominalisation in class 11

uboleko (borrowing)

7. Uboleko lwencwadi lwenzeka esikolweni.
(The borrowing of the book happened at school).

uboleko	
ARGSTR	= ARG 1 = e : r D – ARG 1 = y : location
EVSTR	= D - E 1 = e ₁ : process D - E 2 = e ₂ : state Restr = Temporally ordered Head = e ₂
QUALIA	= FORMAL = (e _r , x, y) AGENTIVE = -boleka _ [Event] (e ₁ , x)

Hierarchy of semantic concepts

Borrow - Location - Event

The explanation of the lexical semantic representation of **uboleko** is similar to that of **umboleko** in (6) above. The distinguishing difference is found in the formal quale which specifies the feature [Event] in (7), which is absent in (6).

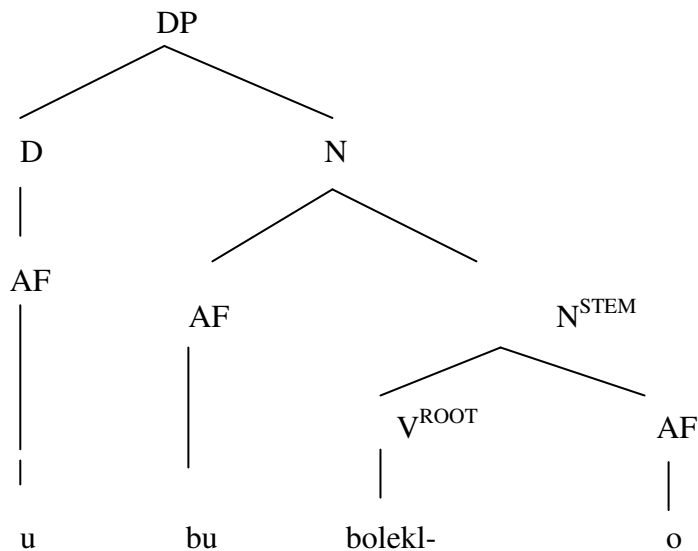
Class 14Prefix: **ubu-**Suffix: **-o****ububoleko** (Quality of borrowing)**Nominalisation in class 14****ububoleko** (quality of borrowing)

8. Ububoleko beencwadi bamnceda umfundi kwimviwo.
 (The quality borrowing of books helped the student in the examination).

ububoleko

ARGSTR = ARG 1 = e : r

D-ARG 1 = x : human

D - ARG 1 = y : location

EVSTR = D - E 1 = e₁ : processD - E 2 = e₂ : state

Restr = Temporally ordered

Head = e₂QUALIA = FORMAL = (e_r, x, y)AGENTIVE = **-boleka** _ [Quality] (e₁, x) _

Hierarchy of semantic concepts

Borrowing - Process - Quality

The lexical semantic representation of the deverbative noun **ububoleko** displays an argument structure containing three arguments. The one argument is the human who has borrowed (something), and the other arguments are the default arguments (i.e. the physical object being borrowed and the other is the location where the physical object benefitted the borrower). These events are temporally ordered and is headed by the state (e_2) event. The formal role in the qualia structure represents the quality act of borrowing.

Observation regarding the analysis of ditransitive change of possession verbs:

The above analysis of deverbatives derived from ditransitive change of possession verbs demonstrate that:

A. The ditransitive change of possession verbs take an animate argument, the event is a process and one formal quale occurs in terms of which the animate argument is in a process of borrowing (e_1, x).

B. Nominalisation in class 1

The analysis reflects the analysis of the ditransitive verb **boleka** in (1) above except that the argument is only human, hence the semantic concepts refers to this feature, that is, [human]. The presence of the prefix **um-** and the suffix **-i** compositionally realize an interpretation of human for **umboleki**.

C. Nominalisation in class 7

The class 7 deverbative noun **isiboleki** with the suffix **-i** denotes the feature human. The analysis of class 7 **isiboleki** in (3) above, is similar to that of class 1 nominalisation in (2). The only difference relates to the agentive quale which displays the feature [intensive] introduced by the prefix **isi-** in class 7. The deverbative noun **isiboleki** can appear as a head in a NP taking a descriptive possessive realized as a cognate noun

D. **Nominalisation in class 9**

The class 9 deverbative **imboleki** in (4) above can be analysed in a similar way to class 7, the only difference relates to the agentive quale which displays the feature [expert] introduced by the prefix **-in** in class 9. On the other hand the deverbative **imboleko** has an agentive quale which displays the feature feature [Action] introduced by the suffix **-o** in class 9.

E. **Nominalisation in class 3**

The class 3 deverbative **umboleko** with the suffix **-o** denotes the feature inanimate. The analysis of class 3 deverbative is similar to that of **uboleko** in class 11 nominalisation, the only difference relates to the agentive quale which displays the feature [Manner] introduced by the prefix **um-** and the suffix **-o** in class 3.

F. **Nominalisation in class 11**

The argument **uboleko** in class 11 can be analysed in a similar way to (7) above. The only difference relates to the agentive quale which demonstrates the feature [Event] introduced by the prefix **u(lu-)**. In class 11 the deverbative noun **uboleko**, refers to an individual level nominal which is defined to a particular event.

G. **Nominalisation in class 14**

The argument **ububoleko** in class 14 can be analysed in a similar way to class 11 in (8) above. The only difference relates to the agentive quale which exhibits the feature [Quality] introduced by the prefix **ubu**. In class 14 the deverbative noun **ububoleko** refers to the stage level nominal which is defined to a particular event.

The ditransitive change of possession verbs can be analysed in a similar way in those instances where there are classes of occurrence. It seems that not all these deverbatives are mostly specified for all classes of nouns, particularly in deverbal nominals derived from the verbs **nika**, **ondla**, and to a lesser extent **pha**. Most deverbative nouns derived from class 1, class 7 and class 9 denote a person where the where the nominal suffix is **-i**. In situations where the nominal suffix is **-o**,

particularly in class 9, a different interpretation can be exhibited as is the case with **imbeko** in class 9:

In summar, the examples of deverbatives derived from ditransitive put verbs demonstrate that these deverbatives are mostly prevalent in classes 1 and class 7. The deverbatives in class 1 and class 7 denote count nouns where the nominal suffix is **-i**. Only one deverbative in class 9, **imboleki**, denotes count nouns where the nominal suffix is **-i**. The deverbatives in class 11 denote event where the nominal suffix is **-o**. The deverbatives in class 3 denote manner of event where the nominal suffix is **-o**. There is only one deverbative in class 9, **imboleko** in class 9 denoting action where the nominal suffix is **-o**.

The deverbatives in class 14 denote quality where the nominal suffix is **-o**. The deverbatives denoting humans where the nominal suffix is **-i** can readily be associated with corresponding plural nouns, however, the deverbatives in class 9 which have other semantic features do not readily take a corresponding plural form, as can be illustrated with the uncharacteristic deverbative ***imboleko**. It is evident that the set of lexical semantic representations of the range of nominals derived from the transitive put verbs with a locative argument in sub-section 4.4.1 of chapter 4 can be analysed in terms of a similar lexical semantic representations presented in sub-section 5.4.1 of chapter 5 as is demonstrated in the analysis of the ditransitive verb of change **boleka** in sub-section 5.4.1 above.

5.5 CONCLUSION

In this chapter, I have shown that deverbal nominals derived from intransitive state verbs demonstrate various aspects pertaining to the compositionality and the semanticity of derived nominals. In chapter 4 and chapter 5, it is evident that deverbal nominals derived from class 1 tend to show a preponderance towards expressing an argument that is only human. It seems that the occurrence of the prefix **um-** and the suffix **-i** compositionally realise an interpretation of human for all deverbal nominals derived from class 1. This is further illustrated by the qualia structure which specifies the formal quale expressing the identity of the human argument (X), and the agentive quale displaying the state (e_1) being experienced by a human. Thus, the deverbal nominals **umlambi** and **umgodoli** in class 1 share similar semantic feature, [Human], hence, it can be concluded that class 1 is a class which specifies only human.

It is clear that in almost all the instances of class 1 where the deverbal nominals are derived from intransitive verb classes, they denote human irrespective of the verb type form from which it is derived. The only exception pertains to the deverbal nominals derived from weather verbs. Thus, weather verbs do not have a [Human] dimension in them, hence, they cannot be derived through class 1. The examples of deverbal nominals specified in sub-section 4.2.5 of chapter 4 and sub-section 5. 2.5 of chapter 5 clearly show the absence of deverbal nominals derived from class 1 in weather verbs.

In this research, it has also been found that deverbal nouns derived from class 5 are very limited. These deverbal nominals in class 5 can be analysed in a similar way as class 1, since they denote [Human] most of the time. The presence of the prefix **i** and the suffix **o / a** compositionally realize for an interpretation of [Human]. The only difference pertains to the fact that the formal quale of most deverbal nominals in class 5 display the feature [derogatory], as is illustrated by the following deverbal nominals derived from various intransitive verbs **ilamba**, **ibhityo**, **ilila**, **idangala**, **iqumba** and **iphuma**. There are very few deverbal nouns derived from transitive verbs in class 5 whose formal quale exhibit the feature [derogatory], **iphula**, **ibhimbiliza**, **icula**, **ibamba** and **inyumbaza**. This study has revealed that some transitive verb classes do not allow the derivation of deverbal nominals in class 5, particularly perception verbs, verbs of cognition, search verbs, remove verbs, change of possession verbs and put verbs with a locative argument.

The analysis of deverbal nominals in class 7 has demonstrated that these deverbal nominals can be analysed similar to class 1 nominalisation, particularly, in instances where the prefix **i** and the suffix is **i / a** compositionally realize for an interpretation of [Human]. The only difference in class 7 relates to the formal quale which displays the feature [intensive], as is indicated by the following deverbal nouns, **isilambi**, **isiluphali**, **isithimli**, **isilima**, **isikhweleti**, **isifiki**, **isijoji**, **isiginyi**, **isiqapheli**, **isirwebi**, **isixhomi**, **isikhami** and **isithumi**.

It is clear that the deverbal nominals in class 7 are a heterogeneous group in terms of their interpretation. Some deverbal nominals derived from class 7 exhibit other features particularly, in instances where the suffix is **o/i** as can be illustrated by the deverbal nominals **isililo** whose formal quale display the feature [Action / Result], **isigulo** displays the feature [state]. The deverbal nominals derived from weather verbs, change of state verbs, search

verbs, creation verbs and put verbs, have a formal quale which displays the feature [instrument] in class 7, as in **isivuthuzi, isivuli, isivalo, isifuni, isichweli, isixovulo, isitshizi** and **isilayisho**, whereas the nominals derived from motion verbs with a locative argument, **isihlalo**, has a formal quale which exhibits the feature [artifact].

The analysis of deverbal nominals derived from class 9 has shown that these deverbal nominals compositionally exhibit the interpretation of an [expert human] in circumstances where the prefix is **i** and the suffix is **i**, as displayed by these deverbal nominals, **imbaci, imvuli, inkweli, inkculi, intloli, intlafuni, ingqondi, intlabi, imbethi, ingxothi** and **imboleki**. The class 9 deverbal nominals with the suffix **o** tend to display either an [action], [action/result] or [state] interpretation, as is demonstrated by deverbal nominals such as **inkuthalo, intimlo, inkathalo, ingulo, ingqumbo, indudumo, imbuyo, injongo, impicotho, inginyo, impazamo, intlukuhlo, intwalo, inkxwitho** and **intumo**.

In class 11 most deverbal nominals have a formal quale which exhibits the feature [event] as is demonstrated by the deverbal nominals derived from verbs relating to bodily processes, experiencer verbs, search verbs, cognition verbs, contact verbs, put verbs, remove verbs with a locative argument and change of possession verbs. Some few derived nominals have a formal quale which displays the feature [event, manner] as is illustrated by the derived nominals derived from weather verbs, change of state verbs and creation verbs. The deverbal nominals that have been derived from perception verbs have a formal quale which demonstrates the feature [action result].

All the deverbal nominals that have been derived in class 14 have a formal quale which displays the feature [quality] as is shown by the deverbal nominals derived from all the verb classes indicated, except for weather verbs which do not have deverbal nominals derived in class 14.

CHAPTER 6

CONCLUSIONS

6.1 REVIEW OF THE STUDY

The concluding chapter of this dissertation shall be dedicated to providing major findings and insights arrived at in the foregoing five chapters. In the introduction, I mentioned that, the deverbal nominals in African languages are well-known from a descriptive perspective, including those in Xhosa. Descriptive grammars are more concerned only with the variations of noun class membership as derivational markers in Xhosa morphology. I highlighted that the potential theoretical and empirical insights from African languages like Xhosa remained largely unexplored in studies on deverbative nominalizations.

The fundamental question addressed in this dissertation concerns the question of how the syntactic properties of verbs from which deverbal nouns are derived and invoked in explaining the argument structure and event structure properties of deverbal nouns (Barker 1998, Brinton 1995, Di Sciullo and Williams 1987, Grimshaw 1990, Hazout 1994, Rothstein 2004, Rozwadowska 2000 and Siloni 1997).

In this study, I have examined the semantics and morpho-syntactic properties of the Xhosa deverbal nouns within the paradigm of the Generative Lexicon Theory (Pustejovsky 1996). I have looked at how the syntactic properties of verbs from which deverbal nouns are invoked in explaining the argument structure, event properties and qualia structure of deverbal nouns. The rationale for turning to Pustejovsky's Generative Lexicon Theory is because the descriptive analyses studies of deverbal nominals do not sufficiently elucidate the semantics of words. As a result, I utilized Pustejovsky, precisely because he presents a more comprehensive perspective of the lexicon by providing appropriate theoretical devices and principles to make important generalizations as regards aspects of the semantic and morpho-syntax of deverbal nouns in Xhosa. A view supported by Busa (1996) who claimed that the lexicon is an essential and coherent component of linguistic knowledge, which provides insights on how word meaning interacts with a set of generative mechanisms to account for the creative use of language. Levin (1993: 16) cites Grimshaw (1990), Rappaport and Levin (1988) who proposed lexical semantic representations that take the form of predicate decomposition, a notion dealt with in the Generative Lexicon.

In Chapter 1, I pointed out that the descriptive nature has been the hallmark of studies on deverbal nouns in African languages in general. I stated the need to look at deverbal nominalisation from a theoretical perspective so as to identify and remedy the short-comings of the descriptive analysis which seemed to have its own flaws. I suggested the Generative Lexicon Theory as it has all the required devices to systematically interpret derived deverbal nominals.

In section 2.2 chapter 2, I provided a synopsis of the definitions of important lexical terms followed by the descriptive nature of deverbal nominals in Xhosa, in section 2.3. In section 2.3, I explored the descriptive nature of deverbal nominals, focusing on various derivations of deverbatives. I mentioned that every noun belongs to a noun class by virtue of the form of its prefix (Poulos nad Msimang 1998).

The lexical interpretation of the derived nouns is arbitrary as the derivation of nouns in Zulu showed. In noun class 7 the derived nouns may denote a derived certain language or culture or behavior patterns characterizing a certain group of individuals as illustrated in **umlungu** (white person) > **isilungu** (White way of doing things). In the derivation of **ugwayi** (tobacco) > **isigwayi** (field of tobacco) the derived class 7 nouns denote plantation. The fundamental issue in the derivation of deverbal nominals in African languages relates to prefixation and suffixation onto the verb root. This is true for the morphological and semantic derivation of the deverbatives in Xhosa as is illustrated in the verbs of change of state below:

	Class 1	cl. 3	cl. 7	cl. 9	cl. 11	cl. 14
-phula 'break (something brittle into pieces)'	umphuli 'person who breaks (things)'	umphulo 'event/manner of breaking'	isiphuli 'expert person who breaks (things)'		uphulo 'act of breaking'	ubuphuli 'state of breaking'
-qhekeza 'break in/ off'	umqhekezi 'person who breaks in (burglar)'	umqhekezo 'event of breaking off'	isiqhekezi 'expert person in breaking off'	inkqhekezo 'act of breaking off'	uqhekezo 'state of breaking off'	

A prefix **um-** and a suffix **-i** occurs with the noun **umqhekezi**: [**um-**[qhekez]**[i]**] (burglar) from the verb **-qhekez-** (break). The suffix **-i** appeared with this class 1 deverbative, having an underlying verbal form with an external argument in their argument structure representation. The class 9 derived nominal [**in-**[qhekez]**[o]**] ('act of breaking/burglary') from

the same verb [-**qhekez-**] (break) has an underlying verbal form with an internal argument in its argument structure. This generalisation was, however, problematic, in that it does not fully explain the difference between the same noun interpreted as either an event, or the manner in which the event is performed.

A generalisation for the purpose of characterising the interface between morphology and syntax could be assumed to be a hypothesis that can best explain semantic interpretation. A syntactic generalisation is inadequate to account for nominals that are not derived from verbal forms. It was therefore necessary to invoke grammatical and semantic properties for certain linguistic phenomena, the event based information that was associated with the verbal stem which partially determined the availability of a derived noun. Pustejovsky's generative lexicon is capable of handling such generalisations. I have shown in chapter 5 and in section 6.3 of chapter 6 that the Generative Lexicon Theory is able to account for the derivation of these deverbatives by employing its three levels of representation as shown below:

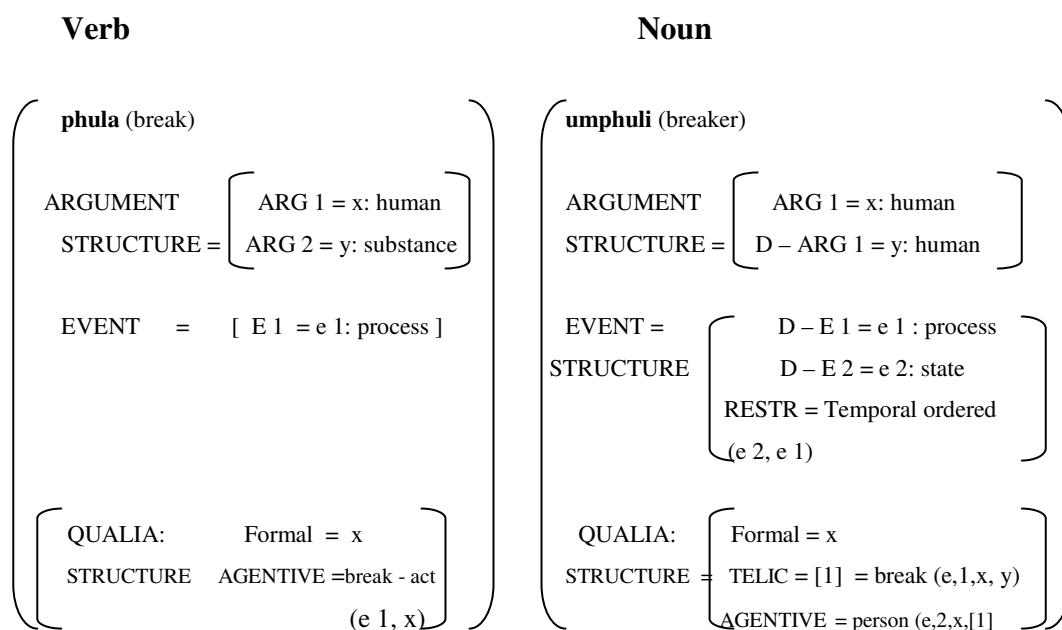

One of the pertinent virtues of deverbal nominals in African languages relate to the similar way in which personal and impersonal deverbatives are characterized. I have shown that Siswati personal deverbatives are characterized by the ending **-i** and impersonal deverbatives by the ending **-o** or **-a** to the root as explained by Ziervogel and Mabuza (1976). The examples below illustrated this similarity:

Personal deverbatives

- (a) umtsakatsi- ‘sorcerer’ < -tsakats- ‘practise sorcery’
 (b) intfombi- ‘girl’ < -tfomb- ‘reach puberty’

The Venda personal deverbatives showed similar characteristics like the Siswati deverbatives as demonstrated by Poulos (1990):

Personal deverbatives

- (a) -funz- ‘instruct’ (verb root) > mufunzi (1) ‘missionary’
 (b) -l- ‘eat’ (verb root) > muli (1) ‘eater’

I have observed in the derivation of personal and impersonal deverbatives of Northern Sotho the arbitrary nature in which the derived deverbal nominal were suffixed. There seemed to be no clear distinction between the personal and impersonal suffixation. The examples provided by Poulos and Louwrens (1994) briefly expressed this phenomenon below:

Personal deverbatives

- (a) ngwal- ‘write’ (verb root) > mongwadi (1) ‘writer’
 (b) -rat- ‘love’ (verb root) > moratiwa (1) ‘beloved’

Impersonal deverbatives

- (a) -thab- ‘be happy’ (verb root) > lethabo (5) ‘joy’
 (b) -gwap- ‘dry up’ (verb root) > mogwapa (3) ‘dried meat’

This study has shown that all nouns in African languages, including sub-Saharan African languages, are specified for a certain noun class realized through prefixes (Du Plessis 1997) a view supported by Katamba (2003). The rules governing these prefixes are regarded as concordance rules (Burton and Kirk 1976) and that noun class prefix are at the heart of an extensive system of concord (i.e agreement) in Bantu as seen in Swahili (Katamba 2003). I have shown that the derivation of nouns in Zulu also occurs within noun classes and have denotations that are determined by context in which they are used.

I have also looked at the semantic reality of syntactic category in Bantu languages and highlighted the notion that the syntactic function of Bantu noun class can be accounted for, whereas the semantic status of noun classes is obscured (Burton and Kirk 1976). It is evident

in the semantics of noun classes in Proto-Bantu that noun prefixes realize a semantic system where each prefix is associated with a characteristic meaning. We also saw the categorization of noun classes in terms of 1/2 human, 3/4 plants, 5/6 fruit, 7/8 artifact and 9/10 animals (Denny and Creider 1986). The notion of the classification of nouns in terms of a class system seemed to be the determining criteria of nouns. It is against this backdrop that prefixation is regarded as being the hallmark of Bantu nominal morphology.

In chapter 3, I surveyed Pustejovsky's (1996) Generative Lexicon Theory (henceforth GLT) wherein I explored the problem associated with the semantics of words, particularly, the problem of compositionality. We saw that Pustejovsky explored the GLT based on two important notions, co-compositionality and type coercion. Pustejovsky considered two assumptions that play an important role in a lexical semantic framework; the appreciation of syntactic structures of a language and the nonlinguistic conceptual organizing principles.

In the GLT, Pustejovsky, provided four levels of representation so as to capture the lexical meaning: Argument Structure which refers to the semantic arguments that a word takes. He distinguished four types of arguments for lexical items; True Arguments which are covered by the Θ - criterion which requires arguments to be expressed as syntactic constituents, Default arguments, Shadow Arguments and True Adjuncts. The Qualia Structure which deals with the defining features of a word and includes the *formal*, *constitutive*, *telic* and *agentive roles*, Event Structure which refers to the classification of the different types of eventualities in the world into semantic verbal classes.

We have seen that Pustejovsky regarded the structural information for event structure as not being sufficient to capture lexical distinctions that languages make, with respect to the relative prominence or importance of the sub-events of a larger event. He argued that event headedness provided a way of indicating a type of foregrounding and backgrounding of event arguments. He represented headedness to the event structure in the example provided below:

$$\left(\begin{array}{l} \alpha \\ \text{EVENTSTR} = E_2 = \left(\begin{array}{l} E_1 = \dots \\ \dots \\ \text{RESTR} = \dots \\ \text{HEAD} = E_1 \end{array} \right) \\ \dots \end{array} \right)$$

Pustejovsky argued that the four levels of representation were connected by means of three generative devices: *type coercion* where a lexical item or phrase is coerced to a semantic interpretation by a governing item in the phrase, without change to its syntactic type, *selective binding* which refers to a situation whereby a lexical item selects some feature from the qualia structure of another lexical item, without changing the overall type in the composition and *co-composition* which entails the derivation of new senses.

In the qualia structure of nominals, Pustejovsky examined the typing system necessary to characterize the semantics of nominals by introducing the analysis of a category in terms of the four levels of representation, and assumed a system based on typed feature structures as applied in Copestake and Briscoe, (1992), Copestake, (1993), and Pustejovsky and Boguraev, (1993). Of critical importance in the polysemous behaviour of nominals is the notion of the Lexical Conceptual Paradigm (lcp) which projects the means of characterizing a lexical item as a meta entry.

In this study, Busa (1996) outlined the contribution of the GLT to the study of nominalization. She stated that the GLT was based on a view of the lexicon as an active set of mechanisms which exploit the internal structure of lexical items to compositionally account for meaning shifts. She pointed out that the GLT argued against a view of lexical structures as an unstructured set of specifications of syntactic categories and primitive semantic features. Rather, the lexicon contained ‘pre-syntactic’ information based on the semantic type (viz. Cognitive structures), which take the form of qualia roles.

Busa argued that the GL theory was able to handle nominalization, viewed in syntax as a category-changing operation, which required the positing of an abstract verbal category **auth** for the nominal **author**. She maintained that the nouns **author** and **writer** share semantic similarities which are not derived from the verbal category **write** and the hypothetical **auth**,

but rather from the semantic type: namely, they both refer to individuals who are defined with respect to a particular event. She further stated that an event cannot be identified without a complement which defines the individual, as is illustrated by the examples below:

- (a) the author of the book
(the writer of the book)
- (b) the author of this painting
(the painter of this painting)
- (c) the author of the robbery
(the perpetrator of the robbery)

Pustejovsky (1996) provided a distinction between stage-level and individual level predicates and individual-level predicates. He cited Carlson (1977) who argued that stage-level predicates are predicated of stages, and represent a temporary or transitory quality, while individual-level predicates are predicated of individuals and represent more permanent qualities as illustrated in the examples below:

- (a) Firemen are available.
- (b) Firemen are intelligent.

In explaining the properties of individual-level nominals, Busa (1991), stated that one of the crucial properties of individual-level nominals was that the individual was defined as α – er need not be engaged in the activity α at the time of reference. She pointed out that individual-level nominals fail to license frequency adjectives whereas stage –level nominals were able to license spatial and temporal modifiers. The notion of individual and stage-level nominals received attention in section 6. 3.

6.2 A COMPARATIVE VIEW OF NOMINAL DERIVATIONS ACROSS VERB CLASSES

In chapter 4, In order to demarcate the crux of this dissertation I have had to categorize the derivation of the deverbatives in terms of intransitive, transitive and di-transitive verbs, wherein I utilized noun classes 1, 3, 5, 7/8, 9, 11 and 14 to derive each deverbative from the various verb classes, as illustrated in the lexical schematic representation throughout Chapter 4. In sub-section 4.2.1, I have observed that the intransitive state have a predominance of

derived deverbal nominals in noun classes 1, 7/8 less in noun class 14, and only four derived deverbatives in noun classes 5, 9 and 11 respectively. In noun class 3 only one deverbal nominal was derived. The predominant semantic type for state verbs was the [Person] semantic type found in noun classes 1, 5, 7/8 and only one deverbal nominal denoted [Person] in noun class 9. Only one deverbal nominal which denoted the [Inchoative state] and four deverbatives denoted the [Result], whereas only two deverbatives denoted [State] and [Quality] semantic types.

In sub-section 5.2.1 of chapter 5, the intransitive state verb that was analyzed was the verb – **lamba** which served as a representative of all intransitive state verbs. The lexical semantic representation of the state verb –**lamba** in noun class 1 displayed a single argument in its argument structure (ARGSTR) in the form of a human. In noun class 5 the lexical semantic representation of the deverbative **ilamba** also displayed a single argument in its argument structure (ARGSTR) indicating that only a human was capable of being hungry. The lexical semantic representation of the deverbative **isilambi** could be explained similarly to the deverbal nominals derived in noun classes 1 and 5 respectively. I observed that though these different noun classes demonstrated the semantic notion [human/person] there was a difference amongst these deverbal nominals that was located in their qualia structures.

The formal quale of the deverbative **umlambi** specified the identity of the physical object (X), whereas that of the deverbative **ilamba** displayed the feature [derogatory], and the deverbative **isilambi** demonstrated the feature [intensive]. I noticed in the intransitive motion verbs with a locative argument in sub-section 2.2.6 that the deverbal nominal **imfiki** had a semantic notion [human] and displayed a formal quale [expert]. The same was true for the intransitive verbs relating to the body in noun class 9 which had the semantic notion [human] deverbal nominals such as **inkohleli**, **imbodli**, and **inkroni** displayed the formal quale [expert].

In sub-sections 4.2.5 and 5.2.5, the intransitive weather verbs did not have deverbal nominals derived from the noun classes which denoted [human/person]. The weather verbs demonstrated in the lexical schematic representation that the deverbal nominals derived from this verb class occurred mostly in noun classes 9 and 11 respectively. The formal quale distinguished the differences between these noun classes. I showed that in noun class 9 the deverbal nominal **imvuthuzo** specified the formal quale [result] and it referred to an individual-level nominal, whereas the deverbative **uvuthuzo** demonstrated a formal quale

with the feature [event]. Only a single deverbal nominal **umvuthuzo** occurred in noun class 3 with the formal quale representing the identity of the wind whilst the deverbal nominal **isivuthuzi** specified the formal quale with the feature [instrument] and it referred to a stage – level nominal.

In section 5.3 of chapter 5, I analyzed transitive verbs and observed some similarities and differences with intransitive verbs in section 4.3 of chapter 4. Firstly, the similarities related to the manner in which the derived deverbal nominals were interpreted in noun classes 1, 5, 7/8 and 9. I observed that the interpretation of the deverbal nominals derived from these noun classes was similar in so far as the denotation of the argument being [human/person] as shown in the deverbal nominals derived from transitive creation verbs such as **umchweli**, **umculi**, and **icula** in sub-section 4.3.2. The same similarities applied in the different noun classes 7 and 9 where the distinction between these arguments **isichweli**, **isiculi**, and **inkweli** and **inkculi** was determined by the formal quale and the agentive as being [intensive] and [expert] respectively.

Secondly, the differences were that with intransitive verbs relating to the body, the lexical semantic representation of the derived deverbal nominal demonstrated in their argument structure (ARGSTR), only one argument. The transitive verbs displayed in their lexical semantic representation of the derived deverbal nominals two arguments in their argument structure (ARGSTR). One argument denoting [human/person] and the other argument represented the physical object. I observed that the other difference had to do with the event structure as the event structure of some deverbal nominals derived from intransitive verbs relating to the body have only a single default event, whereas deverbal nominals derived from transitive verbs displayed two default events in general.

Thirdly, I observed that the deverbal nominals derived from intransitive motion verbs with a locative argument also displayed two arguments in its argument structure (ARGSTR), one argument representing the person and the other argument, a default argument, represented the location. The argument structure of deverbal nominals derived from transitive verbs of change of state displayed an argument denoting a [person] and the other argument represented the physical object, my emphasis.

In section 5.4 of chapter 5, I have shown that the deverbal nominals derived from ditransitive change of possession verbs could also be analyzed in a similar manner in relation to the

denotation [human] in noun classes 1, 5, 7 and 9 as was the case with deverbal nominals derived from intransitive and transitive verbs. The only difference could be the fact that the deverbal nominals derived from ditransitive verbs displayed three arguments in their lexical semantic representation where one argument denoted [human] and the other default arguments represented the physical object whilst the other displayed the location as demonstrated for the deverbal nominal **imboleki** below:

-imboleki	
ARGSTR	= ARG 1 = e : r D- ARG 1 x : phys(ical obj(ect)) D – ARG 2 = y : location
EVSTR	= E 1 = e ₁ : process E 2 = e ₂ : state Restr(ucturing) = Temporally ordered Head = e ₂
QUALIA	= FORMAL = X AGENTIVE = -boleka _ act_expert (e ₁ , x)

6.3 INSIGHTS FOR FURTHER SIGNIFICANT RESEARCH

In this last chapter, I outlined the characteristics of the individual deverbal nominals derived from the different verb classes. I highlighted the predominant similarities and differences found across deverbatives derived from various verb classes. One of the particular issues that have arisen during the analysis of these deverbal nominals related to the interpretation of the deverbatives as to whether these deverbatives could be interpreted in terms of the individual-level nominals or in terms of stage-level nominals, particularly the deverbatives in noun classes 1, 5, 7 and 9 denoting person. In my observation it seemed as if the deverbal nominals denoting a person in noun classes 7 and 9 with the habitual, always and expert characteristic have the interpretation of an individual-level nominal. In deverbatives denoting person in noun class 5 the habitual or the derogatory feature is a lifelong attribute of a person, hence, the interpretation is that of stage-level nominal as indicated in sub-section 4.22 of chapter 4 in motion verbs. It seemed the deverbal nominals denoting person in noun class 1 with the characteristic of habitual or always may be interpreted more of a stage-level nominal. But, it seemed if certain complements are used with these deverbatives, the interpretation may be that of individual-level nominals depending on the context. The data in chapter 4 provided a

plethora of examples where this issue could be further investigated, I leave it for future research.

The derivation of the deverbals in noun class 5 seemed to show very few deverbatives in this noun class across all verb classes even in the most productive of all verb classes, the verbs relating to the body (bodily processes) in sub-section 4.2.3 as only two deverbatives, **ilila** and **idangala** were derived respectively. With weather verbs not a single deverbative denoting person is derived. In transitive verbs of change of state and creation verbs only one deverbative was derived for each verb class, **iphula** and **icula** respectively. Contact verbs displayed only two deverbatives derived in noun class 5, **ibamba** and **inyumbaza** respectively. The question remains why does noun class 5 exhibit such a limited array of derived deverbals. Thus, I leave this question open for further research.

REFERENCES

- Abney, s. 1987. **The English noun phrase in its sentential aspect**. PhD dissertation MIT.
- Áfarli, T.A. 2002. **Two Types of Object Experiencer Verbs in Norwegian**. *Journal of Compative Germanic Linguistics* 4: 129-144, 2002. © 2002 Kluwer Academic Publishers. [Online] Available: <http://www.springerlink.com/content/1axlnq2cgjyut5qk/>.
- Alexiadou, A. and Grimshaw, J. 2008. **Verbs, nouns and affixation**. In: Working papers of the SFB 732 Incremental Specification in Context 01 (2008): 1-16 Schafer, Florian (ed.) [Online] Available: [http:// www.de/opus/volltexte/2008/3545](http://www.de/opus/volltexte/2008/3545) [Accessed 21 November, 2008].
- Andersen, I. 2007. **Deverbal nouns, Lexicalization and syntactic change**. *Nordic journal of Linguistics* vol 30, no. 1, 55-86. 2007 Cambridge University Press.
- Aronoff, M., and Anshen, F. 1988. "Morphology and the lexicon: lexicalization and productivity. In : Spencer, A., Zwicky, A.M. (eds) **The handbook of morphology**. Blackwell.
- Atuxta, A. 2000. **Telicity: a Lexical Feature or a Derived concept?** [Online] Available: [http:// www.ling.umd.edu/publications/generals/atuxta.pdf](http://www.ling.umd.edu/publications/generals/atuxta.pdf) [Accessed 21 November, 2008].
- Barker, C. 1998. Episodic – ee in English: A thematic role constraint on new word formation. **Language**, Volume 74.
- Baumbach, E.J.M. 1987. **Analytical Tsonga Grammar**. University of South Africa Muckleneuk.
- Bouillon, P., and Busa, F. 2001. **The language of word meaning**. Cambridge University Press.
- Brindle, J.A. 2009. **On the Identification of Noun Class and Gender Systems in Chakali**. MA: Cascadilla Proceedings Project.

- Brinton, L.J. 1995. **'The Aktionsart of deverbal nouns in English'**. In P.M. Bertinetto et al (eds). **Temporal reference, aspect and actinality: vol. 1: Semantic and syntactic perspectives**. Rosenberg & Sellie Publishers.
- Burton, M., and Kirk, L. 1976. Semantic reality of Bantu Noun Classes. **Studies in African Linguistics**, Volume 7.
- Busa, F. 1991. **The Semantics of Agentive Nominals in the Generative Lexicon**. [Online] Available: [http:// www.cs.brandeis.edu/~jamesp/classes/prague/agentive.ps](http://www.cs.brandeis.edu/~jamesp/classes/prague/agentive.ps) [Accessed 14 August, 2008].
- Busa, F. 1996. **Compositionality and the semantics of nominals**. Unpublished Ph.D Dissrtation, Brandeis Unversity.
- Cascio, V.L. and Vet. C.1986. **Temporal Structure in Sentence and Discourse**. Foris Publications.
- Chomsky, N. 1965. **Aspects of the Theory of Syntax**. MIT Press.
- Chomsky, N. 1970. **Remarks on nominalization**. **Readings in transformational grammar**. In: Jacobs and Rosenbaum (eds), 184-221. Waltham, MA: Ginn.
- Cinque, G. 1994. On the evidence for partial N-movement in the Romance DP. In Cinque, G., J. Koster, J-Y. Pollock, L. Rizzi and R. Zanuttini. **Paths towards Universal Grammar: Studies in Honour of Richard Kayne**. Georgetown: Georgetown University Press.
- Contini-Morava, E. 1994. **Noun Classification in Swahili**. [Online] Available: [http:// wwwiath.virginia.ed/swahili/swahili.html](http://wwwiath.virginia.ed/swahili/swahili.html).
- Cook, V. and M. Newson. 1996. **Chomsky's Universal Grammar: An introduction**. Second edition. Oxford: Blackwell Publishers.
- Crystal, D. 1987. **A Dictionary of Linguistics and Phonetics**. Basil Blackwell Ltd.
- Denny, J.P. and Creider, C.A. 1986. The semantics of noun classes in Proto-Bantu. In: Craig, C. **Noun classes and categorization**. John Benjamins.
- Di Sciullo A.M. and Williams, E. 1987. **On the definition of word**. MIT Press.

- Dingamane, M. 2006. **The semantics of Bantu noun classification**. [Online] Available: <http://www.markdingamane.nl/linguistics/bantu-noun-class-semantics.pdf>.
- Du Plessis, J.A. 1978. **IsiXhosa 4**. Oudiovista.
- Du Plessis, J.A. 1997. **Morphology of the African Languages**. Stellenbosch Communications in African Languages, No. 6:
- Du Plessis, J.A. 2000. **Lexical semantics**. Stellenbosch Communications in African Languages, No. 14:
- Du Plessis, J.A. and Visser, M. 1992. **Xhosa Syntax**. Via Afrika Limited.
- Gibbard, G, Rohde, H. And Rose, S. 2009. **Moro Noun Class Morphology**. MA: Cascadilla Proceedings Project.
- Grimshaw, J. 1990. **Argument structure**. MIT Press, Cambridge, MA.
- Guisti, G. 1997. The categorial status of determiners. In Haegeman, L. (ed.). **The new comparative syntax**. London and New York: Longman.
- Haegeman, L. (ed.) 1997. **The new comparative syntax**. London and New York: Longman.
- Haegeman, L. 1994. **Introduction to Government and Binding Theory**. Blackwell.
- Haegeman, L. 1997. Introduction: On the interaction of theory and description on syntax. In Haegeman, L. (ed.). **The new comparative syntax**. London and New York: Longman.
- Hazout, I. 1994. Nominalizers in theta theory. **The Linguistic Review**, Volume 11.
- Hazout, I. 1995. Action Nominalizations and the Lexicalist Hypothesis. **Natural Language and Linguistic Theory**, Volume 13.
- Herbert, R.K. 1985. Gender systems and semanticity: two case histories from Bantu. **In: Historical Semantics Historical Word-Formation**. Mouton Publishers.
- Huddleston, R. and Pullum, G.K. 2002. **The Cambridge Grammar of the English Language**. Cambridge University Press.

- Katamba, F. 2003. '**Bantu nominal morphology**' , in Derek Nurse & Gerard Philippson (eds.), *Bantu languages*. London: Routledge, 103-120.
- Katamba, F. and Stonham, J.T. 2006. **Morphology**. Palgrave MacMillan.
- Kearns, K. 2000. **Semantics**. MacMillan Press.
- Kornai, A. 1988. **Compositionality, of, word-formation**. [Online] Available: <http://people.mokk.bme.hu/~kornai/Paper/compof.pdf> [Accessed 10 November, 2008].
- Krüger, C.J.H. 2006. **Introduction to the Morphology of Setswana**. LINCOM GmbH 2006.
- Levin, B. 1993. **English Verb Classes and Alternations**. The University of Chicago Press.
- Louw, J.A. and Jubase, J.B. 1963. **Handboek van Xhosa** Bona Printers.
- Markova, A.S. 2007. **Deverbal nominals in Bulgarian: A syntactic analysis**. MA thesis, University of Barcelona, Spain. [Online] Available: <http://www.recercat.cat/bitstream/2072/4353/1/MA> [Accessed 15 December, 2008].
- Melloni, C. 2007. **Polysemy in word formation: The case of deverbal nominals**. Unpublished Ph. D. dissertation, University of Verona, 2007. [Online] Available: <http://morbo.lingue.unibo.it/melloni/chiara-melloni-downloadable-papers.html> [Accessed 15 December, 2008].
- Mufwene, S.S. 1980. **Bantu Class Prefixes: Inflectional or Derivational?** In: *Papers from the Seventeenth Regional Meeting of the Chicago Linguistic Society*, 245-255. CLS.
- Payne, D.L. and Olsen, D. 2009. **Maa (Maasai) Nominalization: Animacy, Agentivity and Instrument**. MA: Cascadilla Proceedings Project.
- Plag, I. 1998. **Word-Formation in English**. Cambridge University Press.
- Pollock, J-Y. 1989. Verb movement, Universal Grammar and the structure of IP. **Linguistic Inquiry** 20, 365-424.
- Poulos, G. 1990. **A Linguistic Analysis of Venda**. Via Afrika Limited.
- Poulos, G. And Louwrence, L.J. 1994. **A Linguistic Analysis of Northern Sotho**. Via Afrika Limited.

- Poulos, G. and Msimang, C.T. 1998. **A Linguistic Study of Zulu**. Via Afrika Limited.
- Pustejovsky, J. 1996. **The Generative Lexicon**. MIT Press, Cambridge, MA.
- Pustejovsky, J. 1998. **The semantics of lexical underspecification**. [Online] Available: [http:// www.cs.brandeis.edu/~jamesp/article/index.html](http://www.cs.brandeis.edu/~jamesp/article/index.html) [Accessed 7 February, 2008].
- Pustejovsky, J. 2000. **Events and the semantics of opposition**. CSLI Publications. [Online] Available: [http:// www.cs.brandeis.edu/~jamesp/classes/prague/agentive.ps](http://www.cs.brandeis.edu/~jamesp/classes/prague/agentive.ps) [Accessed 7 February, 2008].
- Pustejovsky, J. 2000. Lexical Shadowing and Argument Closure In: **Polysemy Theoretical and Computational Approaches**. Oxford University Press.
- Pustejovsky, J. 2001. **Generativity and explanation in semantics**. [Online] Available: [http:// www.cs.brandeis.edu/~jamesp/article/type-c](http://www.cs.brandeis.edu/~jamesp/article/type-c) [Accessed 7 February, 2008].
- Pustejovsky, J. 2001. **Type construction and the logic of meaning**. [Online] Available: [http:// www.cs.brandeis.edu/~jamesp/article/persist...](http://www.cs.brandeis.edu/~jamesp/article/persist...) Accessed 7 February, 2008].
- Pustejovsky, J. and Boguraev, J. 1996. **Lexical Semantics: The problem of Polysemy**. Clarendon Press.
- Radford, A. 2009. **Analysing English Sentences. A Minimalist Approach**. Cambridge University Press.
- Radford, N. 2004. **Minimalist Syntax: Exploring the structure of English**. Cambridge: Cambridge University Press.
- Rauh, G. 2010. **Syntactic categories: Their identification and description in linguistic theories**. Oxford: Oxford University Press.
- Rizzi, L. 1997. The fine structure of the left periphery. In Haegeman, L. (ed.). **Elements of grammar**. Dordrecht: Kluwer Academic Press, 2083-337.
- Rizzi, L. 2001. On the position 'Int(errogative) in the left periphery of the clause. In Cinque, G., and G. Salvi (eds.). **Current issues in Italian Syntax**. Amsterdam: Elsevier, 287-296.

- Rizzi, L. 2003. Locality and left periphery. In Belletti, A. (ed.). **Structures and beyond: The Cartography of syntactic structures**, vol. 2. Oxford: Oxford University Press.
- Rothstein, S. 2004. **Structuring Events: A study in the Semantics of Lexical Aspect** Blackwell Publishing Ltd.
- Rozwadowska, Bozena. 2000. Event structure, argument structure and the **by-** phrase in Polish nominalizations. In P. Coopmans, M. Everaert and J. Grimshaw (eds). **Lexical specification and insertion**. John Benjamins Publishing Company.
- Ryder, M.E. 1999. Bankers and blue-chippers: an account of –er formations in Present-day English. **English Language and Linguistics**, Volume 3. Cambridge University Press.
- Schadeberg, T.C. 2001. **Number in Swahili grammar**: Swahili Forum **8**, 7-16.
- Shopen, T. 1985. **Language typology and syntactic description** Cambridge University Press.
- Siloni, T. 1997. **Noun Phrases and Nominalizations: The Syntax of DPs**. Kluwer Academic Publishers.
- Smith, C.S. 1997. **The Parameter of Aspect**. Kluwer Academic Publishers.
- Teny, T. and Pustejovsky, J. 2000. **A History of Events in Linguistic Theory**. CSLI Publications. [Online] Available: <http://www.cs.brandeis.edu/~jamesp/article/history-of-events.pdf> [Accessed 20 August, 2008].
- Tsujimura, N. And Iida, M. 1999. **Deverbal nominals and Telicity in Japanese**. *Journal of East Asian Linguistics* **8**, 107-130, 1999. [Online] Available: <http://www.springerlink.com/content/t17431566016n> [Accessed 20 May, 2008].
- Van Gelderen, E. 1993. **The rise of functional categories**. Amsterdam/Philadelphia: John Benjamins Publishing Company.
- Visser, M. 2008. Definiteness and specificity in the isiXhosa determiner phrase. **South African Journal of African languages** vol 28(1):11-29.

Wechsler, S. 2007. **A diachronic account of English deverbal nominals.** *Cascadilla*

Proceedings Project. [Online] Available: <http://www.linguistics.berkeley.edu/wccf/26/paper1707.pdf> [Accessed 13 February, 2008].

Ziervogel, D. And Mabuza, E.J. 1976. **A Grammar of the Swati Language (siSwati).** J.L. Van Schaik Limited.