

Numerical Indefinite Integration using the Sinc Method

by

Akinola Richard Olatokunbo

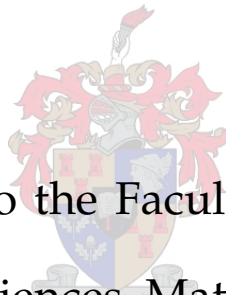

Thesis presented to the Faculty of Science, Department of Mathematical Sciences, Mathematics Division, Stellenbosch University, South Africa, in partial fulfilment of the requirements for the degree of Master of Science in Mathematics.

Supervisor: Prof. Dirk Pieter Laurie

March 2007

Declaration

I, the undersigned, hereby declare that this thesis contains no material which has been accepted for a degree or diploma by Stellenbosch University or any other institution, except by way of background information and duly acknowledged in the thesis, and that, to the best of my knowledge and belief, this thesis contains no material previously published or written by another person, except where due acknowledgement is made in the text of the thesis.

Signature

Date

Abstract

In this thesis, we study the numerical approximation of indefinite integrals with algebraic or logarithmic end-point singularities. We show the derivation of the two quadrature formulas proposed by Haber based on the sinc method, as well as, on the basis of error analysis, by means of variable transformations (Single and Double Exponential), the derivation of two other formulas: Stenger's Single Exponential (SE) formula and Tanaka *et al.*'s Double Exponential (DE) sinc method. Important tools for our work are residue calculus, functional analysis and Fourier analysis from which we state some standard results, and give the proof of some of them. Next, we introduce the Paley-Wiener class of functions, define the sinc function, cardinal function, when a function decays single and double exponentially, and prove some of their interesting properties. Since the four formulas involve a conformal transformation, we show how to transform from the interval $(-\infty, \infty)$ to $(-1, 1)$.

In addition, we show how to implement the four formulas on two computational examples which are our test problems, and illustrate our numerical results by means of tables and figures. Furthermore, from an application of the four quadrature formulas on two test problems, a plot of the maximum absolute error against the number of function evaluations, reveals a faster convergence to the exact solution by Tanaka *et al.*'s DE sinc method than by the other three formulas.

Next, we convert the indefinite integrals (our test problems) into ordinary differential equations (ODE) with suitable initial values, in the hope that ODE solvers such as Matlab[®] ode45 or Mathematica[®] NDSolve will be able to solve the resulting IVPs. But they all failed because of singularities in the initial value. In summary, of the four quadrature formulas, Tanaka *et al.*'s DE sinc method gives more accurate results than the others and it will be noted that all the formulas are applicable to both singular and non-singular integrals.

Opsomming

In hierdie tesis bestudeer ons die numeriese benadering van onbepaalde integrale met algebraïese of logaritmiëse eindpunt-singulariteite. Ons toon die afleiding van die twee kwadratuurformules voorgestel deur Haber gebaseer op die sinc-metode, asook, gebaseer op foutanalise, deur middel van veranderlike-transformasie (Enkel-en Dubbel-Ekponensiaal), die afleiding van twee ander formules: Stenger se Enkel-Ekponensiaal (SE) formule en Tanaka *et al.* se Dubbel-Ekponensiaal (DE) sinc-metode. Belangrike gereedskap vir ons werk sluit in residu-rekene, funksionaalanalise en Fourier-analise waarvan ons sommige standaard- resultate toon, sommige met bewys. Daarna stel ons die Paley-Wiener klas van funksies bekend, definieer die sinc-funksie, die kardinaalfunksie, wanneer 'n funksie enkel-en-dubbel-eksponensiaal verval, en bewys sommige van hulle interessante eienskappe. Aangesien die vier formules 'n konforme transformasie insluit, wys ons hoe om die interval $(-\infty, \infty)$ na $(-1, 1)$ te transformeer.

Verder toon ons aan hoe om die vier formules te implementeer op twee voorbeeldberekenings wat ons toetsprobleme is en illustreer ons numeriese resultate deur middel van tabelle en figure. Verder, van 'n toepassing van die kwadratuurformules op twee toetsprobleme, toon 'n grafiek van die maksimum absolute fout teen die aantal funksie-evaluasies 'n vinniger konvergensie na die presiese oplossing in die geval van Tanaka *et al.* se DE sinc-metode as by die ander drie formules.

Volgende doen ons die omskakeling van die onbepaalde integrale (ons toetsprobleme) na gewone differensiaalvergelykings (GDV) met geskikte beginvoorwaardes, in die hoop dat GDV-oplossers soos Matlab[®] ode45 of Mathematica[®] NDSolve die gevolglike probleem sal kan oplos. Hulle misluk egter almal weens singulariteite in die beginvoorwaardes. Ter opsomming, van die vier formules gee Tanaka *et al.* se DE sinc-metode meer akkurate resultate as die ander en dit sal opgemerk word dat al die formules toepasbaar is op beide singuliere en nie-singuliere integrale.

Acknowledgements

When Liverpool Football Club won the 2005 UEFA Champions League, some of the players testified that "a Hand from above wanted them to win" coming back from a three-nil down against A.C. Milan. And now I want to join the Liverpool players to testify again that the "the Hand of the Lord has also helped me" for making me a candidate of His favour and mercy, blessed be the name of the Lord.

Credit must also go to my parents Mr & Mrs S. O. Akinola for insisting I must go to school against all odds. To my brothers, sister, friends for supporting me, and for being my Aaron and Hur. To Bro. Ben Okor and his family for constantly standing in the gap on my behalf. Prof. & Mrs Rawlings for the parental role they played. Not forgetting my supervisor Prof. D. P. Laurie for his guidance in the writing of the thesis and for drawing my attention to including a chapter on ODE solvers may God richly reward you all in Jesus name. Thanks also goes to Yves, Kunle, Adetula, Onwunta, Henry, Pierrot, for what Kenza calls "team spirit".

My appreciation also goes to the University of Jos, Nigeria, Jos-Carnegie Partnership Committee, African Institute for Mathematical Sciences (AIMS) and the Faculty of Science, Stellenbosch University, South Africa for the funds provided to complete my MSc.

I would be an ingrate, if I fail to acknowledge the efforts of the staff of the Stellenbosch International office and the staff of the Mathematics Department for being so wonderful. To all my lecturers, Prof. J. A. C Weideman and Prof. H. Prodinger for standing out among them. "Dankie" Mnr Deter de Wet for translating the abstract. My profound appreciation also goes to Prof. Masatake Mori of the Tokyo Denki University, School of Science and Engineering, Japan for sending preprints of the paper Double Exponential formula for Numerical Integration and two others during a private communication. I finish with these words, the gift of a man makes a way for him. Thank you Holy Spirit my Teacher.

Contents

Declaration	ii
Abstract	iii
Opsomming	iv
Acknowledgements	v
List of Tables	ix
List of Figures	x
1 Introduction	1
1.1 The Sinc Function	3
1.1.1 The Sine Integral	4
1.2 Problem Statement	7
1.3 Overview	8
2 Preliminaries	11
2.1 Analytic Functions	11
2.2 Residues	15
2.2.1 Conformal Mapping	17
2.3 Results from Functional Analysis	17
2.4 Results from Fourier Analysis	19
2.4.1 Trigonometric Series	20
2.4.2 Fourier Series Expansion	20

2.4.3	Functions of any Period $p = 2T$	21
2.5	Complex Fourier Series	21
2.6	Fourier Integral	24
2.6.1	Fourier Cosine and Sine Integrals	24
2.6.2	Fourier Cosine and Sine Transform	25
2.6.3	Fourier Integral in Complex form	26
3	Interpolation and Quadrature	32
3.1	The Cardinal function	32
3.2	Derivation of Haber's Formula A	37
3.3	Sinc Approximation on a Strip	39
3.4	Transformation Via Conformal Mapping	51
3.4.1	Approximation over $(-1, 1)$	51
3.5	Derivation of Haber's Formula B	58
3.5.1	Haber's Formula B	63
3.6	Computational Considerations	65
4	Indefinite Integration on $(-\infty, \infty)$	68
4.1	Stenger's SE Formula	68
4.1.1	Finding the Parameters	80
4.2	Function Spaces	82
4.2.1	Error Estimates	83
4.3	Derivation of Tanaka <i>et al.</i> 's Formula	89
4.4	Analysis of Tanaka <i>et al.</i> 's Formula	103
4.4.1	Double Exponential Transformation	103
4.4.2	Determining the Parameters	106
5	Computational Examples	110
5.1	Implementing Haber's Formula A	111

5.2	Implementing Haber's Formula B	115
5.3	Implementing the SE Formula	116
5.4	Implementing Tanaka <i>et al.</i> 's Formula	121
5.5	Performance Evaluation and Analysis of Results	126
6	ODE Solvers	129
6.1	Initial Value Problems	129
6.2	Conclusions	132
6.3	Recommendations for Further Study	133
	Appendix	133
A	The Transformation $w = \tanh\left(\frac{z}{2}\right)$	134
B	Analytic Solutions	135
	Bibliography	135
	Index	139

List of Tables

3.1	The values of σ_k	45
3.2	The values of γ_k	46
5.1	Max. Error of the formulas for $\int_{-1}^v \frac{1}{\pi\sqrt{1-x^2}} dx$	127
5.2	Max. Error of the formulas for $\frac{1}{4\log 2} \int_{-1}^v \log\left(\frac{1+x}{1-x}\right) dx$	127

List of Figures

3.1	Infinite Strip	40
3.2	Infinite Strip	53
4.1	Conformal transformation	95
5.1	Error vs v for $\int_{-1}^v \frac{1}{\pi\sqrt{1-x^2}} dx$, $N = 25$ (Haber A)	112
5.2	Error vs $\phi^{-1}(v)$ for $\int_{-1}^v \frac{1}{\pi\sqrt{1-x^2}} dx$, $N = 25$ (Haber A)	112
5.3	Error vs v for $\int_{-1}^v \frac{1}{\pi\sqrt{1-x^2}} dx$ (Haber A)	113
5.4	Error vs v for $\frac{1}{4\log 2} \int_{-1}^v \log\left(\frac{1+x}{1-x}\right) dx$, $N = 25$ (Haber A)	114
5.5	Error vs $\phi^{-1}(v)$ for $\frac{1}{4\log 2} \int_{-1}^v \log\left(\frac{1+x}{1-x}\right) dx$, $N = 25$ (Haber A)	115
5.6	Error vs v for $\int_{-1}^v \frac{1}{\pi\sqrt{1-x^2}} dx$, $N = 36$. (Haber B)	116
5.7	Error vs $\phi^{-1}(v)$ for $\int_{-1}^v \frac{1}{\pi\sqrt{1-x^2}} dx$, $N = 36$. (Haber B)	117
5.8	Error vs $\int_{-1}^v \frac{1}{\pi\sqrt{1-x^2}} dx$, $N = 36$. (Haber B)	117
5.9	Error vs v for $\frac{1}{4\log 2} \int_{-1}^v \log\left(\frac{1+x}{1-x}\right) dx$, $N = 36$. (Haber B)	118
5.10	Error vs $\phi^{-1}(v)$ for $\frac{1}{4\log 2} \int_{-1}^v \log\left(\frac{1+x}{1-x}\right) dx$, $N = 36$. (Haber B)	118
5.11	Error vs v for $\int_{-1}^v \frac{1}{\pi\sqrt{1-x^2}} dx$, $N = 64$ (SE)	119
5.12	Error vs $\phi^{-1}(v)$ for $\int_{-1}^v \frac{1}{\pi\sqrt{1-x^2}} dx$, $N = 64$ (SE)	120
5.13	Error vs v for $\frac{1}{4\log 2} \int_{-1}^v \log\left(\frac{1+x}{1-x}\right) dx$, $N = 64$ (SE)	121
5.14	Error vs $\phi^{-1}v$ for $\frac{1}{4\log 2} \int_{-1}^v \log\left(\frac{1+x}{1-x}\right) dx$, $N = 64$ (SE)	122
5.15	Error vs v for $\int_{-1}^v \frac{1}{\pi\sqrt{1-x^2}} dx$, $N = 64$, (Tanaka)	123
5.16	Error vs $\phi^{-1}(v)$ for $\int_{-1}^v \frac{1}{\pi\sqrt{1-x^2}} dx$, $N = 64$ (Tanaka)	123

5.17	Error vs v for $\frac{1}{4\log 2} \int_{-1}^v \log \left(\frac{1+x}{1-x} \right) dx, N = 49$ (Tanaka)	125
5.18	Error vs $\phi^{-1}(v)$ for $\frac{1}{4\log 2} \int_{-1}^v \log \left(\frac{1+x}{1-x} \right) dx, N = 49$ (Tanaka)	125
5.19	Error vs $\phi^{-1}(v)$ for $\frac{1}{4\log 2} \int_{-1}^v \log \left(\frac{1+x}{1-x} \right) dx, N = 49$ (Tanaka)	126
5.20	Logarithm of the Max. Error vs N for $\int_{-1}^v \frac{1}{\pi\sqrt{1-x^2}} dx$	128
5.21	Logarithm of the Max. Error vs N for $\frac{1}{4\log 2} \int_{-1}^v \log \left(\frac{1+x}{1-x} \right) dx$	128
A.1	Strip bounded by $y = \pm\pi$	134

Chapter 1

Introduction

By trying often and often, the monkey learns to jump from tree to tree.

Nigerian proverb.

An indefinite integral of a function $f(x)$ is a function $F(x)$ whose derivative $F'(x) = f(x)$ on a certain interval of the x -axis [14]. We assume that $f(x)$ is analytic in a simply connected domain \mathcal{D} [17] which we shall define shortly.

When we talk of indefinite integrals in the parlance of Numerical Analysis, we mean integrals in which the upper limit of integration is a variable [7],

$$F(x) = \int_c^x f(u) \, du. \quad (1.1)$$

This thesis will be restricted to computing the numerical indefinite integrals of integrals in which the lower limit of integration $c = -1$, and in which the upper limit is x for $-1 < x < 1$, using the sinc method. A treatment of other indefinite integrals over such intervals as $(0, x)$: $0 < x < \infty$ and $(-\infty, x)$ using the double exponential formulas is given by Muhammad and Mori [21].

Next, we introduce some notations used in this thesis.

Definition 1.1. 1. *The notation*

$$f(x) \sim g(x), \quad x \rightarrow a$$

which is read "f(x) is asymptotic to g(x) as x → a", means

$$\lim_{x \rightarrow a} \frac{f(x)}{g(x)} = 1.$$

2. *The notation*

$$f(x) = o(g(x)), \quad x \rightarrow a$$

which is read "f(x) is of order less than g(x) as x → a", means

$$\lim_{x \rightarrow a} \frac{f(x)}{g(x)} = 0.$$

3. *The notation*

$$f(x) = O(g(x)), \quad x \rightarrow a$$

which is read "f(x) is of order not exceeding g(x) as x → a", means

$$\lim_{x \rightarrow a} \frac{f(x)}{g(x)} = L < \infty.$$

Alternatively, when the limits do not exist, we say $f(x) = O(g(x))$ as $x \rightarrow a$ if there exists a positive real number A independent of x such that

$$|f(x)| \leq A|g(x)|,$$

for x sufficiently small/large [1].

1.1 The Sinc Function

The word "sinc" is an abbreviation of the phrase "sine cardinal" [34]. The sinc function $\text{sinc}(x)$ arises frequently in Fourier transforms. It is an even function with zeros at $k\pi$ for $k = \pm 1, \pm 2, \dots$, $\lim_{x \rightarrow \pm\infty} \text{sinc}(x) = 0$. Gearhart and Shultz [9] describe it as a well-behaved function and also gives some of its properties.

Definition 1.2. *The sinc function is defined in [18] as*

$$\text{sinc}(x) = \begin{cases} \frac{\sin \pi x}{\pi x}, & x \neq 0 \\ 1, & x = 0. \end{cases} \quad (1.2)$$

From the definition above, it is possible to write the complex integral representation [34] for $x \neq 0$,

$$\begin{aligned} \text{sinc}(x) &= \frac{\sin(\pi x)}{\pi x} \\ &= \frac{e^{i\pi x} - e^{-i\pi x}}{2i\pi x} \\ &= \frac{1}{2i\pi x} [e^{iwx}]_{-\pi}^{\pi} \\ &= \frac{1}{2\pi} \int_{-\pi}^{\pi} e^{iwx} \, dw. \end{aligned}$$

The sinc function has strong relationships with the sine integral. The next section illustrates such relationships.

1.1.1 The Sine Integral

The sine integral is defined in equation (5.2.1) in [2] as

$$\begin{aligned}\text{Si}(x) &= \int_0^x \frac{\sin u}{u} du \\ &= \int_0^x \text{sinc}(u) du \\ &= \frac{\pi}{2} + \text{si}(x),\end{aligned}\tag{1.3}$$

where, from [2]

$$\text{si}(x) = - \int_x^\infty \frac{\sin u}{u} du.\tag{1.4}$$

The sine integral satisfies the symmetry relation $\text{Si}(-x) = -\text{Si}(x)$, which means that it is an odd function. For positive values of x , we find the Maclaurin series of $\frac{\sin x}{x}$ and, integrating term wise, we have

$$\begin{aligned}\text{Si}(x) &= x - \frac{x^3}{3 \cdot 3!} + \frac{x^5}{5 \cdot 5!} - \frac{x^7}{7 \cdot 7!} + \dots \\ &= \sum_{i=1}^{\infty} \frac{(-1)^{i-1} x^{2i-1}}{(2i-1)(2i-1)!}.\end{aligned}\tag{1.5}$$

This series cannot be evaluated efficiently for large values of x , due to computer round-off error.

For $x \geq \pi$, Haber [11] used the following procedure instead for calculating values of the sine integral: Let $n = \lfloor x/\pi \rfloor$ and $\tau = x - n\pi$, where

$$\begin{aligned}\text{Si}(x) &= \text{Si}(n\pi) + \int_{n\pi}^{n\pi+\tau} \frac{\sin t}{t} dt \\ &= \pi\sigma_n + (-1)^n \int_0^\tau \frac{\sin w}{n\pi + w} dw.\end{aligned}\tag{1.6}$$

The σ_n in (1.6) is related to the sine integral by the following relation:

$$\sigma_n = \frac{1}{\pi} \text{Si}(n\pi) \quad \text{and} \quad \sigma_{-n} = -\sigma_n, \quad (1.7)$$

$$\text{Si}(x) = \frac{\pi}{2} - f(x) \cos x - g(x) \sin x. \quad (1.8)$$

From [2], $f(x)$ and $g(x)$ are shown to be asymptotic expansions, given by

$$\begin{aligned} f(x) &\sim \frac{1}{x} \left(1 - \frac{2!}{x^2} + \frac{4!}{x^4} - \frac{6!}{x^6} + \dots \right); \\ g(x) &\sim \frac{1}{x^2} \left(1 - \frac{3!}{x^2} + \frac{5!}{x^4} - \frac{7!}{x^6} + \dots \right). \end{aligned} \quad (1.9)$$

Substituting $x = n\pi$ in (1.8) and (1.9), and using the relation (1.7), we have

$$\text{Si}(n\pi) \sim \frac{\pi}{2} - \frac{(-1)^n}{n\pi} \left[1 - \frac{2!}{n^2\pi^2} + \frac{4!}{n^4\pi^4} - \dots \right]; \quad (n \rightarrow \infty). \quad (1.10)$$

Let n be a positive integer that is greater than zero. From [2], $\text{Si}(n\pi)$ are maximum and minimum values of $\text{Si}(x)$ if n is odd and even respectively.

$$\sigma_n \sim \frac{1}{2} + \frac{(-1)^{n+1}}{n\pi^2} \left[1 - \frac{2!}{n^2\pi^2} + \frac{4!}{n^4\pi^4} - \dots \right]. \quad (1.11)$$

Another method of finding σ_n is to integrate [11]

$$\sigma_n = \frac{1}{2} - \frac{1}{\pi} \int_{n\pi}^{\infty} \frac{\sin t}{t} dt \quad (1.12)$$

by parts to give

$$\int_{n\pi}^{\infty} \frac{\sin t}{t} dt = \frac{\cos n\pi}{n\pi} - \int_{n\pi}^{\infty} \frac{\cos t}{t^2} dt.$$

By continuing to integrate $\int_{n\pi}^{\infty} \frac{\cos t}{t^2} dt$ and subsequent integrands by parts, we ob-

tain

$$\int_{n\pi}^{\infty} \frac{\sin t}{t} dt = \frac{\cos n\pi}{n\pi} - \frac{2! \cos n\pi}{(n\pi)^3} + \frac{4! \cos n\pi}{(n\pi)^5} + \dots$$

$$+ \frac{(2i)! \cos n\pi}{n^{2i+2} \pi^{2i+2}} + (2i+1)! \cos n\pi \int_{n\pi}^{\infty} \frac{\cos t}{t^{2i+2}} dt.$$

Substitution of this into (1.12) yields

$$\sigma_n = \frac{1}{2} + (-1)^{n+1} \left(\frac{1}{n\pi^2} - \frac{2!}{n^3 \pi^4} + \dots \right.$$

$$\left. + \frac{(-1)^i (2i)!}{n^{2i+1} \pi^{2i+2}} + \frac{(-1)^i (2i+1)!}{\pi} \int_{n\pi}^{\infty} \frac{\cos t}{t^{2i+2}} dt \right). \quad (1.13)$$

A question that arises is: what value of n will give σ_n to a desired accuracy? Haber [11] gave an answer to this, suggesting that if we truncate (1.11) at the $(Y-1)$ st term, where

$$Y = \left\lceil \frac{n\pi}{2} \sqrt{1 + \frac{1}{4n^2 \pi^2}} + \frac{1}{4} \right\rceil, \quad (1.14)$$

we will get σ_n as accurate as the asymptotic expansion.

We can obtain the relation (1.7) from (1.12) by using (1.4) as follows

$$\begin{aligned} \sigma_n &= \frac{1}{2} - \frac{1}{\pi} \int_{n\pi}^{\infty} \frac{\sin t}{t} dt \\ &= \frac{1}{2} + \frac{1}{\pi} \text{si}(n\pi) \\ &= \frac{1}{2} + \frac{1}{\pi} [\text{Si}(nx) - \frac{\pi}{2}] \\ &= \frac{1}{\pi} \text{Si}(n\pi). \end{aligned}$$

We can approximate the integral in (1.6) numerically by using a 9-point Gauss-Legendre quadrature formula [11] while the σ_n 's can be computed by the method described above.

A knowledge of their analytic derivation as presented above is worthwhile;

but at this stage of software development $\text{Si}(x)$ values can be easily computed by "one-liners" with numerical software like octave. Consequently, σ_n values can be obtained using (1.7).

1.2 Problem Statement

When one wants to evaluate a definite integral numerically with a constant step size h over an infinite interval $(-\infty, \infty)$, i.e.

$$I = \int_{-\infty}^{\infty} f(u) du, \quad (1.15)$$

in which the integrand $f(u)$ is analytic over $(-\infty, \infty)$, the first thing that comes to mind is the uniformly divided trapezoidal formula [31]

$$I = h \sum_{k=-\infty}^{\infty} f(kh). \quad (1.16)$$

Such a formula is not useful for evaluating integrands with algebraic or logarithmic singularities at one or both ends of the interval of integration.

It appears that ordinary differential equation (ODE) solvers in software packages like Matlab[®] ode45 and Mathematica[®] NDSolve can be used to solve (1.1), but we shall show that they are insensitive to singularities.

The purpose of this thesis is to derive the two quadrature formulas for numerical indefinite integration using the sinc method given by Seymour Haber [11], in which the integrands decay single exponentially. We will show, on the basis of error analysis and by means of the variable transformations, Double Exponential (DE) and Single Exponential (SE), the derivation of the Double Exponential sinc method ([32],[31],[21]) and SE formulas respectively. Finally, we shall look at the relative performances of all four quadrature formulas by plotting the logarithm of

the maximum absolute error against the number of function evaluations on two test problems.

The two integrands that shall be considered have algebraic or logarithmic integrable singularities at the lower bound of integration. Constraints of time and space prevent a discussion of the Clenshaw-Curtis scheme ([5], [7], [8], [12]) in approximating the indefinite integral.

1.3 Overview

In approximating $F(x) = \int_{-1}^x f(u) du$, we shall make two basic transformations: single exponential transformation $w = \phi(z) = \tanh \frac{z}{2}$ and double exponential transformation $w = \phi_1(z) = \tanh \left[\frac{\pi}{2} \sinh(z) \right]$, which map $(-\infty, \infty)$ to $(-1, 1)$. After the transformation, we will then use the well-known trapezoidal formula in part to derive the four quadrature formulas.

Let the given integral be

$$I = \int_c^d f(x) dx. \quad (1.17)$$

Throughout the analysis, we shall be making variable transformations of the form

$$x = \phi(u) \text{ where } \phi(-\infty) = c, \phi(\infty) = d \quad (1.18)$$

to (1.17) so as to change the interval from (c, d) to $(-\infty, \infty)$

$$I = \int_{-\infty}^{\infty} g(u) du; \quad (1.19)$$

hence, after the transformation, we have

$$I = \int_c^d f(x) dx = \int_{-\infty}^{\infty} f(\phi(u)) \phi'(u) du. \quad (1.20)$$

One or both of the endpoints c and d in the original integral can be finite [31]. We now apply the trapezoidal rule (1.16) to obtain the quadrature formula,

$$I = h \sum_{k=-\infty}^{\infty} f(\phi(kh))\phi'(kh), \quad (1.21)$$

bearing in mind that the infinite sum must be truncated in actual computations.

With the above foundation laid, we start by giving the mathematical tools that will be used in deriving the four quadrature formulas in chapter 2, which are fundamental results from analytic functions, calculus of residues, functional analysis and Fourier series analysis. From this, we prove that the sequence of sinc functions forms an orthonormal set.

In chapter 3, we define the cardinal function and give some of its interesting properties. Next, we define the Paley-Wiener class of functions. This is followed by the analysis leading to the derivation of Haber's formulas A and B, given in [11], which we start by using the calculus of residues mentioned in chapter 2 to integrate the contour integral (3.13). Furthermore, we will discuss the conformal transformation $w = \phi(z) = \tanh\left(\frac{z}{2}\right)$ which maps the interval $(-\infty, \infty)$ to $(-1, 1)$. Haber's conditions $\mathbf{A}_1 - \mathbf{A}_5, \mathbf{A}'_1 - \mathbf{A}'_5$, which will be stated in order of relevance, are needed to achieve our aim. In addition, we prove a main result, Lemma 3.1, the integral of $S(k, h, u)$ from $-\infty$ to x , which is crucial in establishing Haber's formulas. This result is also useful in chapter 4.

In chapter 4, we present the analysis leading to the derivation of Stenger's ([27], [32]) SE formula on the basis of error analysis and show how to find the parameters for computing the step size h . Furthermore, in an attempt to find explicit expressions for the step size used in Tanaka *et al.*'s DE sinc method (Tanaka *et al.* formula), we need the function spaces $\mathbf{H}^\infty(D_c, \omega)$ which we introduce, followed by the derivation, on the basis of error analysis Tanaka *et al.*'s formula .

Since the step sizes depend on the values of c and α , which are numbers describing the behaviour of the integrand, we show in chapter 5, how they can be found using two computational examples. The numerical results are presented by means of tables and figures.

In addition, in chapter 6, we show how to convert the indefinite integrals (our test problems) into ODEs with suitable initial values in the hope that mathematical software packages like Matlab[®] ode45 will be able to solve the resulting IVPs. They fail, however, since the integrands have algebraic or logarithmic singularities at the initial value (lower end-point).

In conclusion, after comparing the maximum errors for 376 different values of the upper variable between $(-1, 1)$ for various values of N the number of function evaluations of the four quadrature formulas, we conclude by recommending Tanaka *et al's* formula for the numerical solution of indefinite integrals because of its relative accuracy.

Chapter 2

Preliminaries

He who asks questions never gets lost.

Nigerian proverb.

This chapter begins by providing some well known properties of analytic functions such as the calculus of residues that will be used later to derive Haber's formula. Some useful results from functional analysis are given without proof, as well as some results from Fourier analysis, with proofs where necessary, with the view to find the Fourier transform of $\text{sinc}(u/h)$. The chapter concludes by stating Parseval's theorem and introducing the Paley-Wiener class of functions.

2.1 Analytic Functions

Some definitions and theorems that will help in understanding the sinc function will be discussed in this section.

Given that \mathbb{R} is the set of real numbers, we denote the set of complex numbers by \mathbb{C} . We define a complex number as $z = x + iy$, such that $x, y \in \mathbb{R}, i = \sqrt{-1}$ and the set of complex numbers $\mathbb{C} = \{x + iy : x, y \in \mathbb{R}\}$. We shall denote the extended complex plane by $\bar{\mathbb{C}} = \mathbb{C} \cup \{\infty\}$ [18].

Definition 2.1. (Half-planes) The upper half-plane is the set of all points $z = x + iy$ such that $y > 0$, the lower half-plane is $y < 0$, $x > 0$ is the right half-plane and $x < 0$ is the left half-plane [17].

Definition 2.2. The general equation of a circle of radius ρ and center a is given by

$$|z - a| = \rho. \quad (2.1)$$

Equation (2.1) is the set of all z whose distance $|z - a|$ from the centre is ρ . Its interior, often called an open circular disk, is given by $|z - a| < \rho$ and the exterior is given by $|z - a| > \rho$. The interior plus the circle itself, i.e. $|z - a| \leq \rho$, is called a closed circular disk.

Remark 2.1. An open circular disk $|z - a| < \rho$ is often called a neighbourhood of a .

Definition 2.3. (Interior Point). A point a is called an interior point of a set S , if we can find a ρ neighbourhood of a , all of whose points belong to S .

Definition 2.4. (Open Sets) An open set S is a set which consists only of interior points [23].

Definition 2.5. An open set $S \subseteq \mathbb{C}$ is said to be connected if it cannot be written as the union of two disjoint open sets A and B such that both A and B intersect S [18]. It is said to be simply connected if the complement of S with respect to the extended complex plane i.e. $\overline{\mathbb{C}} \setminus S$ is connected.

Definition 2.6. A domain \mathcal{D} is an open connected set.

Definition 2.7. A complex function f is said to be differentiable with respect to z at $z_0 \in \mathbb{C}$ if

$$f'(z_0) = \lim_{\Delta z \rightarrow 0} \frac{f(z_0 + \Delta z) - f(z_0)}{\Delta z}, \quad (2.2)$$

exists. By letting $z = z_0 + \Delta z$, we have $\Delta z = z - z_0$, and (2.2) becomes

$$f'(z_0) = \lim_{z \rightarrow z_0} \frac{f(z) - f(z_0)}{z - z_0}. \quad (2.3)$$

Definition 2.8. A function f is said to be analytic [17] in a domain \mathcal{D} if it is defined and differentiable at all points of \mathcal{D} . It is said to be analytic at a point $z = z_0$ in \mathcal{D} if it is analytic in a neighbourhood of z_0 , and entire [23] if it is analytic everywhere in the finite plane (everywhere except at infinity).

Theorem 2.1. (Cauchy Integral Theorem) If f is analytic in a domain \mathcal{D} and C is a simple closed contour in \mathcal{D} [13], then

$$\int_C f(z) \, dz = 0. \quad (2.4)$$

The most important consequence of Cauchy's integral theorem is Cauchy's integral formula. We shall state the following theorems without proof. The proofs can be found in [23].

Theorem 2.2. (Cauchy's Integral Formula) Let f be analytic within and on a simple closed contour C [13]. Then, for any point z_0 in the interior of C ,

$$f(z_0) = \frac{1}{2\pi i} \int_C \frac{f(z) \, dz}{z - z_0}, \quad (2.5)$$

where C is positively oriented. Positively oriented means

$$\frac{1}{2\pi i} \int_C \frac{dz}{z - z_0} = 1.$$

Geometrically speaking, C is transversed in a counterclockwise direction.

Theorem 2.3. (Morera's Theorem) If f is a continuous function in \mathcal{D} and for every

simple closed contour [18] C in \mathcal{D}

$$\int_C f(z) dz = 0,$$

then, f is analytic in \mathcal{D} .

Theorem 2.4. (Laurent's Theorem) If f is analytic inside and on the boundary of the annular-shaped [23] region \mathcal{R} bounded by two concentric circles C_1 and C_2 with centre at z_0 and respective radii r_1 and r_2 ($r_1 > r_2$), then for all $z \in \mathcal{R}$,

$$f(z) = \sum_{n=0}^{\infty} a_n (z - z_0)^n + \sum_{n=1}^{\infty} \frac{a_{-n}}{(z - z_0)^n} \quad (2.6)$$

where

$$a_n = \frac{1}{2\pi i} \int_{C_1} \frac{f(z) dz}{(z - z_0)^{n+1}}, \quad n = 0, 1, 2, \dots \quad (2.7)$$

$$a_{-n} = \frac{1}{2\pi i} \int_{C_2} \frac{f(z) dz}{(z - z_0)^{-n+1}}, \quad n = 1, 2, \dots \quad (2.8)$$

We say that a function f is singular or has a singularity at a point $z = z_0$ if $f(z)$ is not analytic (perhaps undefined) at $z = z_0$, but every neighbourhood of $z = z_0$ contains points at which $f(z)$ is analytic [17]. We also say that $z = z_0$ is a singular point of $f(z)$.

The series $\sum_{n=1}^{\infty} \frac{a_{-n}}{(z - z_0)^n}$ is called the principal part of $f(z)$ at the singular point $z = z_0$ [13], while $\sum_{n=0}^{\infty} a_n (z - z_0)^n$ is the analytic part [23] of the Laurent series. The series (2.6) is called the Laurent series expansion of $f(z)$.

Types of Singularities

Assuming that the principal part of the Laurent series has a finite number of terms, i.e. of the form [17]

$$\frac{a_{-1}}{z - z_0} + \frac{a_{-2}}{(z - z_0)^2} + \cdots + \frac{a_{-m}}{(z - z_0)^m}, \quad a_{-m} \neq 0. \quad (2.9)$$

then one can classify the isolated singularities of $f(z)$ at $z = z_0$ into three, namely

1. From (2.9), if $a_{-m} \neq 0$, we say that $z = z_0$ is a pole of order m . It is a simple pole if $m = 1$. More generally, if $z = z_0$ is a pole of $f(z)$, then $\lim_{z \rightarrow z_0} f(z) = \infty$.
2. Whenever $f(z)$ is undefined at $z = z_0$, but $\lim_{z \rightarrow z_0} f(z)$ exists, then z_0 is called a removable singularity.
3. Any singularity that is not a pole or removable singularity is called an essential singularity. In addition, if $z = z_0$ is an essential singularity of $f(z)$, the principal part of the Laurent series expansion has infinitely many terms [23].

2.2 Residues

The coefficient a_{-1} of the first negative power $\frac{1}{z - z_0}$ of (2.6) is called the residue of $f(z)$ at $z = z_0$ and we shall denote it by

$$a_{-1} = \text{Res}(f, z_0). \quad (2.10)$$

In (2.8), the formula is the same as substituting $n = 1$, so that

$$a_{-1} = \frac{1}{2\pi i} \int_C f(z) dz.$$

There are other methods of finding the Laurent series without the use of inte-

gral formulas for the coefficients. We can find a_{-1} by one such method and then use the formula for a_{-1} to evaluate the integral:

$$\int_C f(z) dz = 2\pi i a_{-1}. \quad (2.11)$$

We shall use the Laurent series to show that $f(z) = \text{sinc}(z) = \frac{\sin \pi z}{\pi z}$ is analytic and has a removable singularity at $z = 0$:

$$\begin{aligned} f(z) &= \frac{\sin \pi z}{\pi z} = \frac{1}{\pi z} \left(\pi z - \frac{(\pi z)^3}{3!} + \frac{(\pi z)^5}{5!} - \frac{(\pi z)^7}{7!} + \dots \right), \\ &= \left(1 - \frac{(\pi z)^2}{3!} + \frac{(\pi z)^4}{5!} - \frac{(\pi z)^6}{7!} + \dots \right). \end{aligned}$$

The coefficient of the first negative power of z is 0. Thus, $a_{-1} = \text{Res}(f, 0) = 0$, for all $n > 0$, $a_{-n} = 0$, and from (2.11) we have

$$\int_C f(z) dz = \int_{|z|=\rho} \frac{\sin \pi z}{\pi z} dz = 0.$$

From our definition of a removable singularity, the sinc function is not defined at $z = 0$, $\lim_{z \rightarrow 0} f(z) = 1$, where it is analytic and hence entire.

If $f(z)$ has a pole of order m at $z = z_0$, the residue is given by

$$\text{Res}(f, z_0) = \frac{1}{(m-1)!} \lim_{z \rightarrow z_0} \left\{ \frac{d^{m-1}}{dz^{m-1}} [(z - z_0)^m f(z)] \right\}. \quad (2.12)$$

Suppose $f(z)$ has a simple pole, $f(z) = \frac{p(z)}{q(z)}$, where p and q are analytic at z_0 with $p(z_0) \neq 0$, $q(z_0) = 0$ and $q'(z_0) \neq 0$, then $f(z)$ has a pole of order one and

$$\text{Res}(f, z_0) = \frac{p(z_0)}{q'(z_0)}. \quad (2.13)$$

Theorem 2.5. (Residue Theorem) Let f be analytic inside a simple closed path C and on

C , except for finitely many singular points z_1, z_2, \dots, z_n inside C . Then the integral of $f(z)$ taken counterclockwise around C equals $2\pi i$ times the sum of the residues of $f(z)$ at z_1, z_2, \dots, z_n .

$$\int_C f(z) dz = 2\pi i \sum_{i=1}^n \text{Res}(f, z_i). \quad (2.14)$$

2.2.1 Conformal Mapping

An analytic function f is said to be conformal at a point z_0 in a domain \mathcal{D} if $f'(z_0) \neq 0$. If $f'(z) \neq 0$ for all $z \in \mathcal{D}$, then f is called a conformal mapping on \mathcal{D} .

The geometrical interpretation of this is that, for a complex function $w = f(z) = u(x, y) + iv(x, y)$, where $z = x + iy$, if the angle of intersection of the curves C_1, C_2 at z_0 in the z plane is equal in magnitude and in sense to the angle of intersection of the curves $C'_1 = f(C_1), C'_2 = f(C_2)$ at w_0 , in the w plane, then the mapping is conformal at z_0 .

For a thorough understanding of the analytic properties of the sinc function, we shall discuss its Fourier series and transforms. In order to understand this, however, it is first necessary to list some well known results from functional analysis.

2.3 Results from Functional Analysis

Definition 2.9. Let $p > 0$, the class of functions $f(x)$ which are measurable and for which $|f(x)|^p$ is integrable [6] over $[a, b]$ is known as $\mathbf{L}^p[a, b]$ ¹. $\mathbf{L}^p[a, b]$ is defined for $p \geq 1$ by

$$\|f\|_p = \left(\int_a^b |f(x)|^p dx \right)^{\frac{1}{p}} < \infty, \quad (2.15)$$

and it forms a normed linear space. Here $\|f\|$ is the norm of f with the following properties:

1. $\|f\| \geq 0$ (positivity).

¹We write $\mathbf{L}(\mathbb{R})$ if the interval $[a, b]$ is the entire real line.

2. $\|f\| = 0 \iff f = 0$ (definiteness).
3. $\|\alpha f\| = |\alpha|\|f\|$, where α is a scalar (homogeneity).
4. $\|f + g\| \leq \|f\| + \|g\|$ (triangle inequality).

The distance between $f \in \mathbf{L}^p[a, b]$ and $g \in \mathbf{L}^q[a, b]$ is given by:

$$\|f - g\|_p = \left(\int_a^b |f(x) - g(x)|^p dx \right)^{\frac{1}{p}}. \quad (2.16)$$

Its triangle inequality is the Minkowski's inequality for integrals [6]

$$\left(\int_a^b |f(x) + g(x)|^p dx \right)^{\frac{1}{p}} \leq \left(\int_a^b |f(x)|^p dx \right)^{\frac{1}{p}} + \left(\int_a^b |g(x)|^p dx \right)^{\frac{1}{p}}. \quad (2.17)$$

Definition 2.10. (Hölder's Inequality) For $p > 1$, if $f \in \mathbf{L}^p[a, b]$ and $g \in \mathbf{L}^q[a, b]$ where $\frac{1}{p} + \frac{1}{q} = 1$, then $fg \in \mathbf{L}[a, b]$ and

$$\left| \int_a^b f(x)g(x) dx \right| \leq \left(\int_a^b |f(x)|^p dx \right)^{\frac{1}{p}} \left(\int_a^b |g(x)|^q dx \right)^{\frac{1}{q}}. \quad (2.18)$$

In particular, for $p = q = 2$ we have the Cauchy-Schwartz inequality:

$$\left| \int_a^b f(x)g(x) dx \right| \leq \left(\int_a^b |f(x)|^2 dx \right)^{\frac{1}{2}} \left(\int_a^b |g(x)|^2 dx \right)^{\frac{1}{2}}. \quad (2.19)$$

We define an inner product space thus:

Definition 2.11. Let X be a linear space. A function $(\cdot, \cdot) : X \times X \mapsto \mathbf{C}$ is called an inner product space if, for all $f, g, h \in X$

- (i). $(f+g, h) = (f, h) + (g, h)$ (linearity).
- (ii). $(f, g) = \overline{(g, h)}$ (Hermitian symmetry).

(iii). $(\alpha f, g) = \alpha(f, g) \forall \alpha \in \mathbb{C}$ (left-homogeneity).

(iv). $(f, g) \geq 0, (f, g) = 0 \iff f = 0$ (positivity).

The bar in (ii) above denotes a complex conjugate.

Definition 2.12. A complete, linear, inner product space X with norm

$$\|f\|^2 = (f, f) = \int_a^b |f(x)|^2 dx,$$

and an inner product defined by

$$(f, g) = \int_a^b f(x)\overline{g(x)} dx,$$

is called a Hilbert space.

Definition 2.13. A set S of elements $\{\alpha_i\}_{i=1}^n$ of an inner product space contained in a Hilbert space H is orthonormal if

$$\delta_{ij} = (\alpha_i, \alpha_j) = \begin{cases} 1, & i = j; \\ 0, & i \neq j. \end{cases}$$

2.4 Results from Fourier Analysis

A function is said to be periodic if it is defined for all real x and if there is a positive number p (called the period) such that

$$f(x + p) = f(x), \quad \forall x. \tag{2.20}$$

2.4.1 Trigonometric Series

The importance of Fourier Analysis is to represent a function which is periodic by a trigonometric series.

$$\begin{aligned} f(x) &= a_0 + c_1 \sin(x + \alpha_1) + c_2 \sin(2x + \alpha_2) + \cdots + c_n \sin(nx + \alpha_n) + \cdots \\ &= a_0 + \sum_{n=1}^{\infty} c_n \sin(nx + \alpha_n). \end{aligned} \quad (2.21)$$

Here a_0 is a constant, the $|c_n|$'s are the amplitude of the compound sine term and the α_n 's are the auxiliary angles for all $n = 1, 2, \dots$

$$c_n \sin(nx + \alpha_n) = c_n \cos \alpha_n \sin nx + c_n \sin \alpha_n \cos nx$$

By letting $a_n = c_n \cos \alpha_n$ and $b_n = c_n \sin \alpha_n$, we have

$$c_n \sin(nx + \alpha_n) = a_n \sin nx + b_n \cos nx.$$

$$f(x) = a_0 + \sum_{n=1}^{\infty} (a_n \sin nx + b_n \cos nx). \quad (2.22)$$

The constants a_0, a_n, b_n are referred to as Fourier coefficients and n is a positive integer.

2.4.2 Fourier Series Expansion

Let $f(x)$ be a periodic function with period 2π and integrable over a period. Then the form (2.22) is called the Fourier series expansion of $f(x)$.

The Fourier coefficients are determined from $f(x)$ using Euler's formulas. We shall state the following theorems without a proof but the proof can be found in [17].

Theorem 2.6. (Euler Formulas) *The Fourier coefficients are defined by*

$$a_0 = \frac{1}{2\pi} \int_{-\pi}^{\pi} f(x) dx. \quad (2.23)$$

$$a_n = \frac{1}{\pi} \int_{-\pi}^{\pi} f(x) \cos nx dx, \quad n = 1, 2, 3, \dots \quad (2.24)$$

$$b_n = \frac{1}{\pi} \int_{-\pi}^{\pi} f(x) \sin nx dx, \quad n = 1, 2, 3, \dots \quad (2.25)$$

Often, the period of the function may not be $p = 2\pi$ but $p = 2T$, for example.

2.4.3 Functions of any Period $p = 2T$

The Fourier series of a function $f(x)$ of period $p = 2T$ is given by

$$f(x) = a_0 + \sum_{n=1}^{\infty} \left(a_n \cos \frac{n\pi}{T}x + b_n \sin \frac{n\pi}{T}x \right). \quad (2.26)$$

The Fourier coefficients of $f(x)$ are given by the Euler formulas:

$$a_0 = \frac{1}{2T} \int_{-T}^T f(x) dx. \quad (2.27)$$

$$a_n = \frac{1}{T} \int_{-T}^T f(x) \cos \frac{n\pi}{T}x dx, \quad n = 1, 2, 3, \dots \quad (2.28)$$

$$b_n = \frac{1}{T} \int_{-T}^T f(x) \sin \frac{n\pi}{T}x dx, \quad n = 1, 2, 3, \dots \quad (2.29)$$

We shall derive expressions for the complex Fourier series in the next section.

2.5 Complex Fourier Series

The Fourier series (2.22) can be expressed in complex form. By replacing the x in (2.22) by nx ,

$$e^{inx} = \cos nx + i \sin nx. \quad (2.30)$$

$$e^{-inx} = \cos nx - i \sin nx. \quad (2.31)$$

Adding (2.30), (2.31) and then dividing by 2 yields

$$\cos nx = \frac{e^{inx} + e^{-inx}}{2}. \quad (2.32)$$

In a similar way, subtracting (2.30) from (2.31) and dividing both sides by $2i$ we obtain,

$$\sin nx = \frac{e^{inx} - e^{-inx}}{2i}. \quad (2.33)$$

But we know that $\frac{1}{i} = -i$, thus from (2.22)

$$\begin{aligned} a_n \cos nx + b_n \sin nx &= a_n \frac{(e^{inx} + e^{-inx})}{2} + b_n \frac{(e^{inx} - e^{-inx})}{2i} \\ &= \frac{(a_n - ib_n)}{2} e^{inx} + \frac{(a_n + ib_n)}{2} e^{-inx}. \end{aligned}$$

Let $a_0 = d_0$, $d_n = \frac{a_n - ib_n}{2}$ and $e_n = \frac{a_n + ib_n}{2}$. Substituting these into the above equation, (2.22) becomes:

$$f(x) = d_0 + \sum_{n=1}^{\infty} (d_n e^{inx} + e_n e^{-inx}) \quad (2.34)$$

Using (2.24) and (2.25)

$$d_n = \frac{a_n - ib_n}{2} = \frac{1}{2\pi} \int_{-\pi}^{\pi} f(x) (\cos nx - i \sin nx) dx \quad (2.35)$$

$$= \frac{1}{2\pi} \int_{-\pi}^{\pi} f(x) e^{-inx} dx. \quad (2.36)$$

Similarly,

$$e_n = \frac{a_n + ib_n}{2} = \frac{1}{2\pi} \int_{-\pi}^{\pi} f(x)(\cos nx + i \sin nx) dx \quad (2.37)$$

$$= \frac{1}{2\pi} \int_{-\pi}^{\pi} f(x)e^{inx} dx. \quad (2.38)$$

By letting $e_n = d_{-n}$, and substituting it in (2.34)

$$f(x) = d_0 + \sum_{n=1}^{\infty} (d_n e^{inx} + d_{-n} e^{-inx})$$

then replace the $-n$ in the second sum by m

$$f(x) = d_0 + \sum_{n=1}^{\infty} d_n e^{inx} + \sum_{m=-\infty}^{-1} d_m e^{imx} \quad (2.39)$$

$$= \sum_{n=-\infty}^{\infty} d_n e^{inx}; \quad n = 0, \pm 1, \pm 2, \dots \quad (2.40)$$

where $d_n = \frac{1}{2\pi} \int_{-\pi}^{\pi} f(x)e^{-inx} dx$.

Equation (2.39) is called the complex Fourier series of $f(x)$. The d_n are called the complex Fourier coefficients of $f(x)$.

We then extend (2.39) to functions of period $p = 2T$:

$$f(x) = \sum_{n=-\infty}^{\infty} d_n e^{\frac{in\pi x}{T}}, \quad \text{with } d_n = \frac{1}{2T} \int_{-T}^T f(x)e^{-\frac{in\pi x}{T}} dx. \quad (2.41)$$

Next we will seek to give some useful results from Fourier transforms that will help us in our derivation of the formula for numerical indefinite integration using the sinc function.

2.6 Fourier Integral

In the previous section, we derived expressions for the real and complex Fourier series for $f(x)$. In this section, we shall build on that foundation. We call a representation [17] of the form

$$f(x) = \int_0^{\infty} [A(u) \cos ux + B(u) \sin ux] du, \quad (2.42)$$

the Fourier integral of $f(x)$, where

$$A(u) = \frac{1}{\pi} \int_{-\infty}^{\infty} f(v) \cos uv \, dv, \quad B(u) = \frac{1}{\pi} \int_{-\infty}^{\infty} f(v) \sin uv \, dv. \quad (2.43)$$

If $f(x)$ is piecewise continuous in every finite interval, has both a left- and right-hand derivative at every point and if the integral

$$\lim_{a \rightarrow -\infty} \int_a^0 |f(x)| \, dx + \lim_{b \rightarrow \infty} \int_0^b |f(x)| \, dx = \int_{-\infty}^{\infty} |f(x)| \, dx, \quad (2.44)$$

exists, then $f(x)$ can be represented by a Fourier integral (2.42). At any point of discontinuity of $f(x)$, the value of the Fourier integral is the average of the left- and right-hand limits of $f(x)$ at that point.

2.6.1 Fourier Cosine and Sine Integrals

For odd and even functions, the Fourier integral is simple. If $f(x)$ is an even function, then $B(u)$ in (2.43) equals 0 and

$$A(u) = \frac{2}{\pi} \int_0^{\infty} f(v) \cos uv \, dv. \quad (2.45)$$

The Fourier integral (2.42) then becomes the Fourier cosine integral

$$f(x) = \int_0^{\infty} A(u) \cos ux \, dx. \quad (2.46)$$

Similarly, if $f(x)$ is odd, then in (2.43), $A(u) = 0$ and

$$B(u) = \frac{2}{\pi} \int_0^{\infty} f(v) \sin uv \, dv, \quad (2.47)$$

then

$$f(x) = \int_0^{\infty} B(u) \sin ux \, dx. \quad (2.48)$$

This is referred to as the Fourier sine integral.

2.6.2 Fourier Cosine and Sine Transform

Now we will consider the real and complex Fourier cosine and sine transforms.

We start with the real Fourier cosine and sine transforms:

For an even function, from (2.45), we set $A(u) = \sqrt{\frac{2}{\pi}} \hat{f}_c(u)$ where $\hat{f}_c(u)$ is called the Fourier cosine transform of $f(x)$. By (2.43), with $v = x$,

$$\hat{f}_c(u) = \sqrt{\frac{2}{\pi}} \int_0^{\infty} f(x) \cos ux \, dx \quad (2.49)$$

and

$$f(x) = \sqrt{\frac{2}{\pi}} \int_0^{\infty} \hat{f}_c(u) \cos ux \, du. \quad (2.50)$$

We call $f(x)$ above the inverse Fourier cosine transform of $\hat{f}_c(u)$. With this, we are now in a position to define the Fourier cosine transform [17] as the process of obtaining the transform \hat{f}_c from f .

For an odd function $f(x)$, with $B(u)$ and $f(x)$ as defined in (2.47) and (2.48) respectively, we let $B(u) = \sqrt{\frac{2}{\pi}} \hat{f}_s(u)$. The $\hat{f}_s(u)$ is called the Fourier sine transform

of $f(x)$. With $v = x$ in (2.43) and our definition of $B(u)$ above, we have

$$\hat{f}_s(u) = \sqrt{\frac{2}{\pi}} \int_0^\infty f(x) \sin ux \, dx; \quad (2.51)$$

and

$$f(x) = \sqrt{\frac{2}{\pi}} \int_0^\infty \hat{f}_s(u) \sin ux \, du. \quad (2.52)$$

(2.52) is called the inverse Fourier sine transform of $\hat{f}_s(u)$.

2.6.3 Fourier Integral in Complex form

Recall from (2.42) and (2.43) that $f(x) = \int_0^\infty [A(u) \cos ux + B(u) \sin ux] \, du$, where $A(u) = \frac{1}{\pi} \int_{-\infty}^\infty f(v) \cos uv \, dv$, $B(u) = \frac{1}{\pi} \int_{-\infty}^\infty f(v) \sin uv \, dv$. We substitute A and B into $f(x)$ to give

$$f(x) = \frac{1}{\pi} \int_0^\infty \int_{-\infty}^\infty f(v) [\cos uv \cos ux + \sin uv \sin ux] \, dv \, du.$$

From the trigonometric identities $\cos uv \cos ux + \sin uv \sin ux = \cos(uv - ux)$, therefore $f(x)$ becomes

$$f(x) = \frac{1}{\pi} \int_0^\infty \int_{-\infty}^\infty f(v) \cos(uv - ux) \, dv \, du \quad (2.53)$$

$$= \frac{1}{2\pi} \int_{-\infty}^\infty \left[\int_{-\infty}^\infty f(v) \cos(uv - ux) \, dv \right] \, du. \quad (2.54)$$

Note the change in the interval of integration for u and the $\frac{1}{2}$. Since $\sin x$ is an odd function, it implies that

$$\frac{1}{2\pi} \int_{-\infty}^\infty \left[\int_{-\infty}^\infty f(v) \sin(uv - ux) \, dv \right] \, du = 0. \quad (2.55)$$

Moreover,

$$\begin{aligned} f(v) \cos(uv - ux) + if(v) \sin(uv - ux) &= f(v) [\cos(uv - ux) + i \sin(uv - ux)] \\ &= f(v) e^{iu(v-x)}, \end{aligned}$$

from Euler's formula $e^{ix} = \cos x + i \sin x$. By adding the integrand in (2.53) and i times the integrand in (2.55), and using the above identity,

$$f(x) = \frac{1}{2\pi} \int_{-\infty}^{\infty} \int_{-\infty}^{\infty} f(v) e^{iu(v-x)} dv du \quad (2.56)$$

$$= \frac{1}{2\pi} \int_{-\infty}^{\infty} \left[\int_{-\infty}^{\infty} f(v) e^{iuv} dv \right] e^{-iux} du. \quad (2.57)$$

The expression in the bracket with $v = x$ is called the Fourier transform of f , i.e.

$$\hat{f}(u) = \int_{-\infty}^{\infty} f(x) e^{iux} dx, \quad (2.58)$$

and

$$f(x) = \frac{1}{2\pi} \int_{-\infty}^{\infty} \hat{f}(u) e^{-iux} du, \quad (2.59)$$

is called the inverse Fourier transform of $\hat{f}(u)$. It is important since it can be used to recover a function from its Fourier transform, a technique we shall apply shortly.

Definition 2.14. We define the characteristic function of a set S by

$$\chi_S(x) = \begin{cases} 1, & x \in S; \\ 0, & x \notin S. \end{cases}$$

Example 2.1. We want to use some results derived in this section to write the Fourier expansion for $f(x) = e^{-izx}$, $z \in \mathbb{C}$ and $x \in \left(\frac{-\pi}{h}, \frac{\pi}{h} \right)$, $h > 0$, $f(x) = f(x + T)$ where $T = \frac{2\pi}{h}$ [18].

Using (2.41), we have

$$\begin{aligned}
 d_n &= \frac{1}{2T} \int_{-T}^T f(x) e^{-\frac{in\pi x}{T}} dx \\
 &= \frac{h}{2\pi} \int_{-\frac{\pi}{h}}^{\frac{\pi}{h}} e^{-izx} e^{-inhx} dx \\
 &= \frac{h}{2\pi} \int_{-\frac{\pi}{h}}^{\frac{\pi}{h}} e^{-ix(z+nh)} dx \\
 &= \frac{h}{2\pi} \left[\frac{1}{-i(z+nh)} e^{-ix(z+nh)} \right]_{-\frac{\pi}{h}}^{\frac{\pi}{h}} \\
 &= \frac{h}{2\pi} \left[\frac{1}{(z+nh)i} \{ e^{i\frac{\pi}{h}(z+nh)} - e^{-i\frac{\pi}{h}(z+nh)} \} \right] \\
 &= \frac{h \sin \frac{\pi}{h}(z+nh)}{\pi (z+nh)} \\
 &= \text{sinc} \left(\frac{z+nh}{h} \right).
 \end{aligned}$$

Substituting this into (2.41) we have the Fourier expansion for $f(x)$

$$f(x) = e^{-izx} = \sum_{n=-\infty}^{\infty} e^{inhx} \text{sinc} \left(\frac{z+nh}{h} \right). \quad (2.60)$$

In our bid to derive the formula for numerical integration given by Haber [11], we shall find the Fourier inverse transform of

$$\chi_{[-\frac{\pi}{h}, \frac{\pi}{h}]}^*(x) = \begin{cases} \frac{1}{2}, & x \in (-\frac{\pi}{h}, \frac{\pi}{h}) \\ \chi_{(-\frac{\pi}{h}, \frac{\pi}{h})}, & x \in \mathbb{R} \setminus \{-\frac{\pi}{h}, \frac{\pi}{h}\}, \end{cases} \quad (2.61)$$

given in [18], where, for $h > 0$, $\chi_{(-\frac{\pi}{h}, \frac{\pi}{h})}$ is the characteristic function of the interval $(-\frac{\pi}{h}, \frac{\pi}{h})$. Our intention actually is to find the Fourier transform of $\text{sinc}(\frac{u}{h})$.

To do this, we shall use formula (2.59)

$$\begin{aligned}
\frac{1}{2\pi} \int_{-\infty}^{\infty} \chi_{[-\frac{\pi}{h}, \frac{\pi}{h}]^*}(x) e^{-iux} dx &= \frac{1}{2\pi} \int_{-\infty}^{\infty} \chi_{(-\frac{\pi}{h}, \frac{\pi}{h})}(x) e^{-iux} dx \\
&= \frac{1}{2\pi} \int_{-\frac{\pi}{h}}^{\frac{\pi}{h}} e^{-iux} dx \\
&= \frac{1}{2\pi iu} [e^{\frac{i\pi u}{h}} - e^{-\frac{i\pi u}{h}}] \\
&= \frac{\sin \frac{\pi u}{h}}{\pi u} \\
&= \frac{1}{h} \operatorname{sinc} \frac{u}{h}.
\end{aligned} \tag{2.62}$$

Using (2.58) we have

$$\int_{-\infty}^{\infty} \operatorname{sinc} \frac{u}{h} e^{ixu} du = h \chi_{[-\frac{\pi}{h}, \frac{\pi}{h}]^*}(x). \tag{2.63}$$

Using definition (2.61) and for $x = \pm \frac{\pi}{h}$, we have, from the above,

$$\int_{-\infty}^{\infty} \operatorname{sinc} \frac{u}{h} e^{\pm \frac{i\pi u}{h}} du = \frac{h}{2}.$$

By substituting $u = \xi - t$, $t \in \mathbb{C}$, we find that

$$\begin{aligned}
\int_{-\infty}^{\infty} \operatorname{sinc} \frac{u}{h} e^{ixu} du &= e^{-ixt} \int_{-\infty}^{\infty} \operatorname{sinc} \frac{\xi - t}{h} e^{ix\xi} d\xi \\
\int_{-\infty}^{\infty} \operatorname{sinc} \frac{\xi - t}{h} e^{ix\xi} d\xi &= h e^{ixt} \chi_{[-\frac{\pi}{h}, \frac{\pi}{h}]^*}(x).
\end{aligned} \tag{2.64}$$

Next, we state, not with a proof, but with an illustrative example, Parseval's Theorem given in [18].

Theorem 2.7. (Parseval's Theorem) *If f and g are in $L^2(\mathbb{R})$, then*

$$\int_{-\infty}^{\infty} f(u) \overline{g(u)} du = \frac{1}{2\pi} \int_{-\infty}^{\infty} \hat{f}(x) \overline{\hat{g}(x)} dx,$$

where the bars denote complex conjugates.

Example 2.2. With

$$f(u) = \operatorname{sinc}\left(\frac{u - kh}{h}\right)$$

and

$$\overline{g(u)} = \operatorname{sinc}\left(\frac{u - mh}{h}\right)$$

we shall apply Parseval's Theorem to show that the set

$$\left\{ \frac{1}{h^{1/2}} \operatorname{sinc}\left(\frac{u - kh}{h}\right) \right\}_{k=-\infty}^{\infty}$$

is an orthonormal set.

From Parseval's Theorem,

$$\begin{aligned} \int_{-\infty}^{\infty} \operatorname{sinc}\left(\frac{u - kh}{h}\right) \operatorname{sinc}\left(\frac{u - mh}{h}\right) du &= \frac{1}{2\pi} \int_{-\infty}^{\infty} \hat{f}(x) \overline{\hat{g}(x)} dx \\ &= \frac{h^2}{2\pi} \int_{-\infty}^{\infty} e^{ikhx} e^{-imhx} \chi_{[-\frac{\pi}{h}, \frac{\pi}{h}]}^*(x) dx. \end{aligned}$$

Equation (2.64) was used to obtain the last equality.

Therefore

$$\begin{aligned} \int_{-\infty}^{\infty} \operatorname{sinc}\left(\frac{u - kh}{h}\right) \operatorname{sinc}\left(\frac{u - mh}{h}\right) du &= \frac{h^2}{2\pi} \int_{-\frac{\pi}{h}}^{\frac{\pi}{h}} e^{-ixh(m-k)} dx \\ &= \frac{h \sin[\pi(m-k)]}{\pi(m-k)} \\ &= h \operatorname{sinc}(m-k) \\ &= h \delta_{km}, \end{aligned} \tag{2.65}$$

where δ_{km} is the Kronecker delta function. Thus, we have proved that the set

$$\left\{ \frac{1}{h^{1/2}} \operatorname{sinc}\left(\frac{u - kh}{h}\right) \right\}_{k=-\infty}^{\infty}$$

is an orthonormal set from definition (2.13).

If the Fourier transform of f , i.e. $\hat{f}(f) \in \mathbf{L}^2(-\frac{\pi}{h}, \frac{\pi}{h})$ and

$$f(z) = \frac{1}{2\pi} \int_{-\frac{\pi}{h}}^{\frac{\pi}{h}} \hat{f}(x) e^{-izx} dx, \quad (2.66)$$

then from Morera's Theorem (2.3) f is an entire function. By taking the absolute values of (2.66)

$$\begin{aligned} |f(z)| &= \frac{1}{2\pi} \left| \int_{-\frac{\pi}{h}}^{\frac{\pi}{h}} \hat{f}(x) e^{-izx} dx \right| \\ &\leq \frac{1}{2\pi} e^{\pi|z|h} \int_{-\frac{\pi}{h}}^{\frac{\pi}{h}} |\hat{f}(x)| dx \\ &\leq Ke^{\pi|z|h}. \end{aligned} \quad (2.67)$$

We comment here that if a function f is entire, satisfies (2.67) (of exponential type $\frac{\pi}{h}$) and if, in addition, $f \in \mathbf{L}^2(\mathbb{R})$, then it has a Fourier transform [18]. The converse of this is given in the Paley-Wiener Theorem. The proof of this can be found in [27].

Theorem 2.8. (Paley-Wiener Theorem) *Assume that f is entire and $f \in \mathbf{L}^2(\mathbb{R})$. If there are positive constants K and h such that for all $z \in \mathbb{C}$*

$$|f(z)| \leq Ke^{\pi|z|h}, \quad (2.68)$$

then

$$\hat{f} \in \mathbf{L}^2(-\frac{\pi}{h}, \frac{\pi}{h})$$

and

$$f(z) = \frac{1}{2\pi} \int_{-\frac{\pi}{h}}^{\frac{\pi}{h}} \hat{f}(x) e^{-ixz} dx. \quad (2.69)$$

Chapter 3

Interpolation and Quadrature

Whenever life tries to get you down, you have to greet it with a smile. There is nothing more contagious than a positive attitude.

Nigerian proverb.

In this chapter, we shall start with the definition of the cardinal function since it is an infinite series that involves the sinc function. We shall list some characteristics of the Paley-Wiener class of functions in the form of theorems and we shall discuss in greater detail the steps leading to the derivation of Haber's formulas A and B, which involves the conformal transformation from the interval $(-\infty, \infty)$ to $(-1, 1)$ via the transformation $w = \phi(z) = \tanh \frac{z}{2}$.

3.1 The Cardinal function

McNamee, Stenger and Whitney [20] describe the cardinal function as a "function of royal blood whose distinguished properties set it apart from its bourgeois brethren".

Definition 3.1. *Let f be a function which is defined on the real line \mathbb{R} . Then the formal*

series

$$\sum_{k=-\infty}^{\infty} f(kh)S(k, h, x), \quad (3.1)$$

is called the cardinal series of the function f with respect to a positive step size h . If the series (3.1) converges, we denote its sum by $C(f, h, x)$, and the function $C(f, h, x)$ is called the cardinal function (or Whittaker cardinal function) of the function f [20]. Where

$$\begin{aligned} S(k, h, x) &= \operatorname{sinc}\left(\frac{x - kh}{h}\right) \\ &= \begin{cases} \frac{\sin\left[\left(\frac{\pi}{h}\right)(x - kh)\right]}{\left(\frac{\pi}{h}\right)(x - kh)}, & x \neq kh; \\ 1, & x = kh, \end{cases} \end{aligned} \quad (3.2)$$

is the k 'th sinc function with step size h , evaluated at x . Kearfott [16] calls (3.2) the interpolation property of the sinc function.

The truncated cardinal series is given by

$$C(M, N, f, h, x) = \sum_{k=-M}^N f(kh)S(k, h, x),$$

and in general $N \neq M$. But as we are assuming that the functions we shall be dealing with are symmetric [18], hence $N = M$, and the truncated series can be written as

$$C(N, f, h, x) = \sum_{k=-N}^N f(kh)S(k, h, x). \quad (3.3)$$

Interesting properties of the cardinal function are presented in Theorem 3.3 and Corollary 3.1.

Definition 3.2. Let h be a positive constant, then the Paley-Wiener class of functions (denoted by $B(h)$) is the family of entire functions f such that on the real line $f \in \mathbf{L}^2(\mathbb{R})$

and in the complex plane, f is of exponential type $\frac{\pi}{h}$, i.e.

$$|f(z)| \leq Ke^{\pi|z|h}, \quad K > 0.$$

We give a property of the Paley-Wiener class of functions $B(h)$ below.

Theorem 3.1. *If $f \in B(h)$, then for all $z \in \mathbb{C}$*

$$f(z) = \frac{1}{h} \int_{-\infty}^{\infty} f(u) \operatorname{sinc} \left(\frac{u-z}{h} \right) du. \quad (3.4)$$

Proof: We prove this by an interchange in the order of integration [24]. From Theorem (2.8), with (2.59)

$$\begin{aligned} f(z) &= \frac{1}{2\pi} \int_{-\frac{\pi}{h}}^{\frac{\pi}{h}} \hat{f}(x) e^{-ixz} dx \\ &= \frac{1}{2\pi} \int_{-\frac{\pi}{h}}^{\frac{\pi}{h}} \left[\int_{-\infty}^{\infty} f(u) e^{iux} du \right] e^{-ixz} dx \\ &= \frac{1}{2\pi} \int_{-\infty}^{\infty} f(u) \left[\int_{-\frac{\pi}{h}}^{\frac{\pi}{h}} e^{ix(u-z)} dx \right] du \\ &= \int_{-\infty}^{\infty} f(u) \left[\frac{e^{i\pi(u-z)/h} - e^{-i\pi(u-z)/h}}{2\pi i(u-z)} \right] du \\ &= \frac{1}{h} \int_{-\infty}^{\infty} f(u) \operatorname{sinc} \left(\frac{u-z}{h} \right) du. \end{aligned}$$

■

Below is another example of functions belonging to the Paley-Wiener class of functions given in [18].

Theorem 3.2. *If $g \in L^2(\mathbb{R})$, then $c \in B(h)$, where*

$$c(z) = \frac{1}{h} \int_{-\infty}^{\infty} g(u) \operatorname{sinc} \left(\frac{u-z}{h} \right) du. \quad (3.5)$$

Proof: We shall use the result of Theorem 2.7 and equation (2.64):

$$\begin{aligned} c(z) &= \frac{1}{2\pi h} \int_{-\infty}^{\infty} \hat{g}(x) \hat{g} \left(\operatorname{sinc} \left(\frac{u-z}{h} \right) \right) (-x) dx \\ &= \frac{1}{2\pi h} \int_{-\infty}^{\infty} h e^{-ixz} \chi_{[-\frac{\pi}{h}, \frac{\pi}{h}]^*}(x) \hat{g}(x) dx \\ &= \frac{1}{2\pi} \int_{-\frac{\pi}{h}}^{\frac{\pi}{h}} \hat{g}(x) e^{-ixz} dx. \end{aligned}$$

By taking the absolute value of the above expression for $c(z)$, one discovers that $c(z)$ is of exponential type $\frac{\pi}{h}$ in $L^2(\mathbb{R})$ and entire. ■

We are now in a position to derive an exact interpolation and quadrature formula for functions in $B(h)$. These can be found in the theorem below, coupled with all the results obtained earlier.

Theorem 3.3. *Let $f \in B(h)$, then for all $z \in \mathbb{C}$ [18],*

$$f(z) = \sum_{k=-\infty}^{\infty} f(kh) \operatorname{sinc} \left(\frac{z - kh}{h} \right) \quad (3.6)$$

$f(kh)$ means evaluating $f(x)$ at $x = kh$,

$$f(kh) = \frac{1}{h} \int_{-\infty}^{\infty} f(u) \operatorname{sinc} \left(\frac{z - kh}{h} \right) du. \quad (3.7)$$

Moreover, according to [27]

$$\lim_{N \rightarrow \infty} \int_{-N}^N f(x) dx = \lim_{N \rightarrow \infty} h \sum_{k=-N}^N f(kh). \quad (3.8)$$

Proof: From the Paley-Wiener Theorem 2.8, since $f \in B(h)$,

$$f(u) = \frac{1}{2\pi} \int_{-\frac{\pi}{h}}^{\frac{\pi}{h}} e^{-iux} \hat{f}(x) dx. \quad (3.9)$$

With reference to (2.41), $\hat{f}(x)$ has a Fourier series expansion of the form

$$\hat{f}(x) = \sum_{k=-\infty}^{\infty} d_k e^{ikhx}, \quad -\frac{\pi}{h} < x < \frac{\pi}{h}$$

where

$$d_k = \frac{h}{2\pi} \int_{-\frac{\pi}{h}}^{\frac{\pi}{h}} \hat{f}(x) e^{-ikhx} dx = hf(kh). \quad (3.10)$$

The last equality was arrived at from (3.9). Thus

$$\hat{f}(x) = \int_{-\infty}^{\infty} f(u) e^{ixu} du = \begin{cases} h \sum_{k=-\infty}^{\infty} f(kh) e^{ikhx}, & -\frac{\pi}{h} < x < \frac{\pi}{h} \\ 0, & |x| > \frac{\pi}{h}, \end{cases} \quad (3.11)$$

and with this, (3.9) becomes

$$\begin{aligned} f(x) &= \frac{h}{2\pi} \int_{-\frac{\pi}{h}}^{\frac{\pi}{h}} e^{-iux} \sum_{k=-\infty}^{\infty} f(kh) e^{ikhx} du \\ &= \frac{h}{2\pi} \sum_{k=-\infty}^{\infty} f(kh) \int_{-\frac{\pi}{h}}^{\frac{\pi}{h}} e^{-iu(x-kh)} du \\ &= \sum_{k=-\infty}^{\infty} f(kh) \operatorname{sinc} \left(\frac{x-kh}{h} \right). \end{aligned}$$

We can obtain (3.7) by substituting $z = kh$ into equation (3.4). To obtain (3.8), we let $x = 0$ in (3.11) and then the result follows. ■

The corollary below is from (1.10.2) in [27].

Corollary 3.1. *If $f \in B(h)$, then for $x \in \mathbb{R}$,*

$$\int_{-\infty}^{\infty} f(u) e^{ixu} du = \begin{cases} h \sum_{k=-\infty}^{\infty} f(kh) e^{ikhx}, & -\frac{\pi}{h} < x < \frac{\pi}{h} \\ 0, & |x| > \frac{\pi}{h}. \end{cases} \quad (3.12)$$

Having defined the cardinal function, and having mentioned some character-

istics of the Paley-Wiener class of functions, we can now begin to derive Haber's formulas.

3.2 Derivation of Haber's Formula A

We shall start from the contour integral [18]

$$G(z) = \int_{B_{k,\varepsilon}} g(z) dz, \quad (3.13)$$

where

$$g(z) = \frac{\sin \frac{\pi x}{h} f(z)}{(z-x) \sin \frac{\pi z}{h}}.$$

Let h and c be positive constants. From [18] we are given that for each positive integer k , $B_{k,\varepsilon}$ is the rectangular contour with vertical sides $x = \pm \frac{(2k+1)h}{2}$ and horizontal sides $y = \pm(c - \varepsilon)$:

$$B_{k,\varepsilon} = \left\{ z = x + iy : -\left(\frac{2k+1}{2}\right)h < x < \left(\frac{2k+1}{2}\right)h, |y| < (c - \varepsilon) \right\}.$$

We assume that

A₁ **f is analytic in the strip $|y| < c$.**

The assumption **A₁** above is the same as Haber's condition H_1 in [11].

The real number x [11] is less than or equal to kh in absolute value. The singularities of $g(z)$ in (3.13) are $z = x$ and $z = kh$, where k is all integers between $-n$

and n . From our earlier study of residues, using formula (2.13) we have at $z = kh$

$$\begin{aligned}
 \text{Res}(g, kh) &= \frac{\sin\left(\frac{\pi x}{h}\right) f(kh)}{\left[(z-x) \sin\left(\frac{\pi z}{h}\right)\right]'_{z=kh}} \\
 &= \frac{\sin\left(\frac{\pi x}{h}\right) f(kh)}{\left[\sin\left(\frac{\pi z}{h}\right) + \frac{\pi}{h}(z-x) \cos\left(\frac{\pi z}{h}\right)\right]_{z=kh}} \\
 &= \frac{\sin\left(\frac{\pi x}{h}\right) f(kh)}{\left[\sin(\pi k) + \frac{\pi}{h}(kh-x) \cos(\pi k)\right]} \\
 &= \frac{(-1)^k h \sin\left(\frac{\pi x}{h}\right) f(kh)}{\pi(kh-x)} \\
 &= -\frac{h \sin(\pi(x-kh)/h) f(kh)}{\pi(x-kh)} \\
 &= -f(kh) \text{sinc}\left(\frac{x-kh}{h}\right).
 \end{aligned}$$

Thus

$$\text{Res}(g, kh) = -f(kh) \text{sinc}\left(\frac{x-kh}{h}\right). \quad (3.14)$$

The residue at $z = x$ is given by

$$\text{Res}(g, x) = f(x). \quad (3.15)$$

For the singularities, the Residue Theorem 2.5 yields

$$\begin{aligned}
 G(z) &= 2\pi i \left[\text{Res}(g, x) + \sum_{k=-n}^n \text{Res}(g, kh) \right] \\
 &= 2\pi i \left[f(x) - \sum_{k=-n}^n f(kh) \text{sinc}\left(\frac{x-kh}{h}\right) \right].
 \end{aligned}$$

Making $f(x)$ the subject, we have

$$f(x) = \sum_{k=-n}^n f(kh) \text{sinc}\left(\frac{x-kh}{h}\right) + \frac{\sin\frac{\pi x}{h}}{2\pi i} \int_{B_{k,\epsilon}} \frac{f(z) dz}{(z-x) \sin\frac{\pi z}{h}}$$

and

$$\begin{aligned} f(x) &= \sum_{k=-n}^n f(kh) \operatorname{sinc} \left(\frac{x - kh}{h} \right) + R_{k,\varepsilon}(x); \\ R_{k,\varepsilon}(x) &= \frac{\sin \frac{\pi x}{h}}{2\pi i} \int_{B_{k,\varepsilon}} \frac{f(z) dz}{(z - x) \sin \frac{\pi z}{h}}. \end{aligned} \quad (3.16)$$

The above equation holds for $x = \pm nh$, $|n| \leq k$ and for all $x \in [-kh, kh]$.

Haber [11] also gave another condition

A₂ for a small positive ε , each of the integrals $\int_{-\infty}^{\infty} |f(x - i(c - \varepsilon))| dx$ and $\int_{-\infty}^{\infty} |f(x + i(c - \varepsilon))| dx$ exists, and is bounded in ε ;

and

A₃ for each small positive ε , the integral $\int_{\varepsilon-c}^{c-\varepsilon} |f(x + iy)| dy$ is a bounded function of x .

The next section contains some useful identities.

3.3 Sinc Approximation on a Strip

We shall begin this section with the basic and fundamental definitions that will be used.

Definition 3.3. Let \mathcal{D}_c be an infinite strip domain, as illustrated in Figure 3.1, of width $2c$, given in [18] by

$$\mathcal{D}_c = \{z \in \mathbb{C} : z = x + iy, -c < y < c\}. \quad (3.17)$$

Let $f \in \mathcal{B}^p(\mathcal{D}_c)$ be the set of functions that are analytic in \mathcal{D}_c , with $1 \leq p < \infty$ [26], that satisfy

$$\int_{-c}^c |f(x + iy)| dy \rightarrow 0 \text{ as } x \rightarrow \pm\infty. \quad (3.18)$$

and

$$N_p(f, \mathcal{D}_c) = \lim_{y \rightarrow c^-} \left\{ \left(\int_{-\infty}^{\infty} |f(x + iy)|^p dx \right)^{\frac{1}{p}} + \left(\int_{-\infty}^{\infty} |f(x - iy)|^p dx \right)^{\frac{1}{p}} \right\} < \infty. \quad (3.19)$$

For $p = 1$, this is trivial and we shall write $\mathcal{B}^1(\mathcal{D}_c)$ as $\mathcal{B}(\mathcal{D}_c)$.

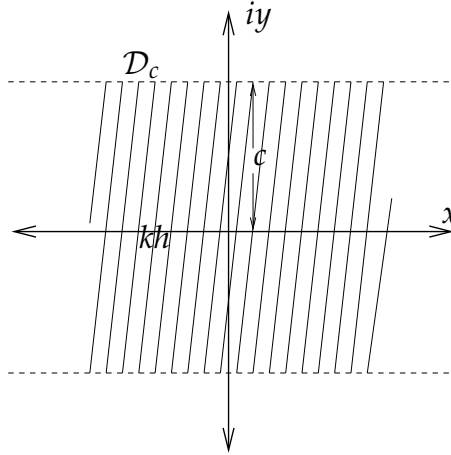

Figure 3.1: The figure above shows the infinite strip [18] \mathcal{D}_c of width $2c$.

The following theorem was proved in [18] (Theorem 2.13) and it gives an interpolation result in $\mathcal{B}^p(\mathcal{D}_c)$.

Theorem 3.4. *Given that $f \in \mathcal{B}^p(\mathcal{D}_c)$ with $p = 1$ or 2 and $h > 0$, then*

$$\begin{aligned} \xi(x) \equiv f(x) - C(f, h, x) &= f(x) - \sum_{k=-\infty}^{\infty} f(kh) \operatorname{sinc} \left(\frac{x - kh}{h} \right) \\ &= \frac{\sin \frac{\pi x}{h}}{2\pi i} R(f, h, x), \end{aligned} \quad (3.20)$$

where

$$R(f, h, x) = \int_{-\infty}^{\infty} \left\{ \frac{f(u - ic^-)}{(u - x - ic^-) \sin \frac{\pi(u - ic^-)}{h}} - \frac{f(u + ic^-)}{(u - x + ic^-) \sin \frac{\pi(u + ic^-)}{h}} \right\} du. \quad (3.21)$$

In addition, if $f \in B^p(\mathcal{D}_c)$, and $p = 1$ or 2 , the infinity norm becomes

$$\|f - C(f, h)\|_\infty \leq \frac{N_p(f, \mathcal{D}_c)}{2\sqrt[p]{\pi c} \sinh \frac{\pi c}{h}} = O(e^{-\frac{\pi c}{h}}). \quad (3.22)$$

Proof: To prove this, we let $y_m = c - \frac{1}{m}$ and define the domain $L_m \subset \mathcal{D}_c$ by

$$L_m = \left\{ z \in \mathbb{C} : z = u + iy, |y| < y_m, |u| < \frac{(2m+1)h}{2} \right\}.$$

We denote the boundary by ∂L_m . Note that, from the application of the Residue Theorem to $G(z)$ in (3.13) and (3.16),

$$\begin{aligned} R_m(x) &= \frac{\sin \frac{\pi x}{h}}{2\pi i} \int_{L_m, \varepsilon} \frac{f(z) dz}{(z-x) \sin \frac{\pi z}{h}} \\ &= f(x) - \sum_{k=-m}^m f(kh) \operatorname{sinc} \left(\frac{x-kh}{h} \right). \end{aligned} \quad (3.23)$$

Taking limits

$$\lim_{m \rightarrow \infty} R_m(x) = \zeta(x).$$

Integrating around the rectangular box yields

$$\begin{aligned} \frac{2\pi i}{\sin \frac{\pi x}{h}} R_m(x) &= \int_{-y_m}^{y_m} \frac{f(\frac{2m+1}{2}h + iy) i dy}{(\frac{2m+1}{2}h - x + iy) \sin [\pi(\frac{2m+1}{2}h + iy)/h]} \\ &+ \int_{y_m}^{-y_m} \frac{f(-\frac{2m+1}{2}h + iy) i dy}{(-\frac{2m+1}{2}h - x + iy) \sin [\pi(-\frac{2m+1}{2}h + iy)/h]} \\ &+ \int_{-\frac{2m+1}{2}h}^{\frac{2m+1}{2}h} \frac{f(u - iy_m) du}{(u - x + iy_m) \sin [\pi(u - iy_m)/h]} \\ &+ \int_{\frac{2m+1}{2}h}^{-\frac{2m+1}{2}h} \frac{f(u + iy_m) du}{(u - x + iy_m) \sin [\pi(u + iy_m)/h]}, \end{aligned} \quad (3.24)$$

but

$$\begin{aligned}
\left| \sin(\pi \{ \pm(2m+1)h/2 + iy \} / h) \right| &= \left| \sin((2m+1)\pi h/2) \cos(\pi iy/h) \right. \\
&\quad \left. + \cos((2m+1)\pi h/2) \sin(\pi iy/h) \right| \\
&= | \pm(-1)^m \cosh(\pi iy/h) | \\
&= | \cosh(\pi iy/h) | \\
&\leq 1.
\end{aligned} \tag{3.25}$$

We used the trigonometric identities $\sin(ix) = i \sinh x$, $\cos(ix) = \cosh x$, and

$$| \pm(2m+1)h/2 - x | \leq | \pm(2m+1)h/2 + iy - x |. \tag{3.26}$$

With the help of (3.25) and (3.26) we obtain

$$\begin{aligned}
&\left| \int_{-y_m}^{y_m} \frac{f((2m+1)h/2 + iy) i \, dy}{\left(\frac{2m+1}{2}h - x + iy \right) \sin[\pi \{ \frac{2m+1}{2}h + iy \} / h]} \right| \\
&\leq \int_{-y_m}^{y_m} \left| \frac{f\left(\frac{2m+1}{2}h + iy\right) i}{\left(\frac{2m+1}{2}h - x + iy \right) \sin[\pi \{ \frac{2m+1}{2}h + iy \} / h]} \right| dy \\
&\leq \frac{1}{\left| \frac{2m+1}{2}h - x \right|} \int_{-y_m}^{y_m} \left| f\left(\frac{2m+1}{2}h + iy\right) \right| dy.
\end{aligned} \tag{3.27}$$

Equation (3.27) tends to 0 as $m \rightarrow \infty$, which comes from condition (3.18). A similar argument holds for the second integral on the right-hand-side of (3.24).

With this, we have succeeded in proving that the integrals over the vertical side of L_m are zero.

Next, we equate (3.23) and (3.24):

$$\begin{aligned}
\zeta(x) &= \lim_{m \rightarrow \infty} R_m(x) \\
&= f(x) - \sum_{k=-\infty}^{\infty} f(kh) \operatorname{sinc} \left(\frac{x - kh}{h} \right) \\
&= \frac{\sin \frac{\pi x}{h}}{2\pi i} \lim_{m \rightarrow \infty} \int_{-\frac{2m+1}{2}h}^{\frac{2m+1}{2}h} \left\{ \frac{f(u - iy_m)}{(u - x + iy_m) \sin [\pi(u - iy_m)/h]} \right. \\
&\quad \left. - \frac{f(u + iy_m)}{(u - x + iy_m) \sin [\pi(u + iy_m)/h]} \right\} du \\
&= \frac{\sin \frac{\pi x}{h}}{2\pi i} \int_{-\infty}^{\infty} \left\{ \frac{f(u - ic^-)}{(u - x + ic^-) \sin [\pi(u - ic^-)/h]} \right. \\
&\quad \left. - \frac{f(u + ic^-)}{(u - x + ic^-) \sin [\pi(u + ic^-)/h]} \right\} du \\
&= \frac{\sin \frac{\pi x}{h}}{2\pi i} R(f, h, x). \tag{3.28}
\end{aligned}$$

Thus, we have been able to prove that the integrals over the horizontal sides with $c^- = c - \varepsilon$ are:

$$R_{\pm} = \int_{-\infty}^{\infty} \frac{f(u \pm i(c - \varepsilon)) du}{(u - x \pm i(c - \varepsilon)) \sin \frac{u \pm i(c - \varepsilon)}{h}}. \tag{3.29}$$

We prove (3.22) inductively for $p = 1, 2$, and then generalise.

When $p = 1$, taking the absolute values of (3.28) together with definition (3.19),

$$\begin{aligned}
|\zeta(x)| &= \left| \frac{\sin \frac{\pi x}{h}}{2\pi i} \int_{-\infty}^{\infty} \frac{f(u \pm ic^-)}{(u \pm x + ic^-) \sin [\pi(u \pm ic^-)/h]} du \right| \\
&\leq \frac{1}{2\pi c \sinh \frac{\pi c}{h}} \int_{-\infty}^{\infty} \{|f(u + ic^-)| + |f(u - ic^-)|\} du \\
&= \frac{N_1(f, \mathcal{D}_c)}{2\pi c \sinh \frac{\pi c}{h}},
\end{aligned}$$

we establish (3.19) for $p = 1$. We then used these trigonometric identities in the proof:

$$\begin{aligned}\sin(\pi(u \pm ic)/h) &= \sin(\pi u/h) \cos(\pm(\pi ic)/h) \pm \cos(\pi u/h) \sin(\pm(\pi ic)/h) \\ &= \sin(\pi u/h) \cosh(\pi c/h) \mp i \cos(\pi u/h) \sinh(\pi c/h) \quad (3.30)\end{aligned}$$

$$|\sin(\pi(u \pm ic)/h)| \geq \sinh(\pi c/h) \quad \text{and} \quad c \leq |u - x \pm ic|.$$

When $p = 2$, we have to take the absolute value of (3.28) again, and obtain

$$|\xi(x)| \leq \frac{1}{2\pi c \sinh \frac{\pi c}{h}} \int_{-\infty}^{\infty} \left\{ \left| \frac{f(u + ic^-)}{(u - x + ic^-)} \right| + \left| \frac{f(u - ic^-)}{(u - x - ic^-)} \right| \right\} du.$$

An application of the Cauchy-Schwartz inequality (2.19) to the integrals above yields

$$\int_{-\infty}^{\infty} \left| \frac{f(u \pm ic^-)}{u - x \pm ic^-} \right| du \leq \left(\int_{-\infty}^{\infty} |f(u - x \pm ic^-)|^{-2} du \right)^{\frac{1}{2}} \left(\int_{-\infty}^{\infty} |f(u \pm ic^-)|^2 du \right)^{\frac{1}{2}}.$$

Making the substitution $q = \frac{u - x}{c^-}$, $du = c^- dq$,

$$\begin{aligned}\int_{-\infty}^{\infty} \frac{du}{|u - x \pm ic^-|^2} &= \int_{-\infty}^{\infty} \frac{du}{(u - x)^2 + \{c^-\}^2} \\ &= \frac{1}{c^2} \int_{-\infty}^{\infty} \frac{du}{\left(\frac{u-x}{c^-}\right)^2 + 1} \\ &= \frac{1}{c^2} \int_{-\infty}^{\infty} \frac{cdq}{1 + q^2} \\ &= \frac{1}{c} \tan^{-1} q \Big|_{-\infty}^{\infty} \\ &= \frac{\pi}{c},\end{aligned}$$

and hence

$$\int_{-\infty}^{\infty} \left| \frac{f(u \pm ic^-)}{u - x \pm ic^-} \right| du \leq \sqrt{\frac{\pi}{c}} \left(\int_{-\infty}^{\infty} |f(u \pm ic^-)|^2 du \right)^{\frac{1}{2}}.$$

Thus

$$|\xi(x)| \leq \frac{1}{2\pi \sinh\left(\frac{\pi c}{h}\right)} \sqrt{\frac{\pi}{c}} \left(\int_{-\infty}^{\infty} |f(u \pm ic^-)|^2 du \right)^{\frac{1}{2}},$$

and using definition (3.19),

$$|\xi(x)| \leq \frac{N_2(f, \mathcal{D}_c)}{2\sqrt{(\pi c)} \sinh\left(\frac{\pi c}{h}\right)}.$$

Similar expressions can be obtained for $p = 3, 4, \dots$ and from (3.22) we conclude that

$$\begin{aligned} \|\xi(x)\|_{\infty} &= \sup_{x \in \mathbb{R}} |f(x) - C(f, h, x)| \\ &\leq \frac{N_p(f, \mathcal{D}_c)}{2\sqrt[p]{\pi c} \sinh\left(\frac{\pi c}{h}\right)} \\ &\leq \frac{2N_p(f, \mathcal{D}_c)}{\sqrt[p]{\pi c}} e^{-\frac{\pi c}{h}} \end{aligned} \quad (3.31)$$

provided $h \leq \frac{2\pi c}{\ln 2}$. ■

Table 3.1: The values of σ_k , as required in Lemma 3.1

k	σ_k	k	σ_k
1	0.589489872236	2	0.451411666790
3	0.533093237618	4	0.474969669884
5	0.520107164191	6	0.483205217498
7	0.514415997123	8	0.487374225058
9	0.511230152637	10	0.489888171154
11	0.509195742008	12	0.491568351669
13	0.507784657813	14	0.492770209375
15	0.506748694472	16	0.493672415178
17	0.505955907917	18	0.494374552834
19	0.505329710440	20	0.494936499571

The following Lemma was proved by Stenger ([27], pages 172-173). It contains

Table 3.2: The values of γ_k , as required in Lemma 3.1

k	γ_k	k	γ_k
0	0.589489872236	11	0.017627390340
1	0.138078205446	12	0.016216306144
2	0.081681570828	13	0.015014448438
3	0.058123567735	14	0.013978485097
4	0.045137494308	15	0.013076279294
5	0.036901946694	16	0.012283492739
6	0.031210779626	17	0.011581355084
7	0.027041772065	18	0.010955157606
8	0.023855927579	19	0.010393210869
9	0.021341981483	20	0.009886107733
10	0.019307570854	21	0.009426192219

an important identity that will help us derive Haber's formula A.

Lemma 3.1. (Main Result) Let $h > 0$, $k \in \mathbb{Z}$, $x \in \mathbb{R}$ and set

$$J(k, h, x) = \int_{-\infty}^x S(k, h, x) dx, \quad (3.32)$$

where $S(k, h, x)$ is as defined in (3.2). Then, for $x \in \mathbb{R}$,

$$|J(k, h, x)| \leq 1.1h. \quad (3.33)$$

Proof: We set

$$I(\xi) = \frac{1}{\pi} \int_{-\infty}^{\xi} \frac{\sin u}{u} du. \quad (3.34)$$

If we let $k = \xi$ (for any $k \in \mathbb{R}$), then we have

$$I(k) = \frac{1}{2} + \sigma_k, \quad (3.35)$$

where

$$\sigma_k = \int_0^k \frac{\sin \pi u}{\pi u} du, \quad \text{alternatively } \sigma_k = \int_0^{k\pi} \frac{\sin u}{u} du, \quad (3.36)$$

$$\gamma_k = \frac{1}{\pi} \int_0^\pi \frac{\sin u}{k\pi + u} du. \quad (3.37)$$

From the definition of σ_k ,

$$\lim_{k \rightarrow \infty} \sigma_k = \frac{1}{2}.$$

Using $\tau = \xi - k\pi$, $k \in \mathbb{Z}$, $0 \leq \tau < \pi$, $\xi \geq 0$. Then, from (3.34):

$$I(\xi) = \frac{1}{\pi} \int_{-\infty}^{k\pi+\tau} \frac{\sin u}{u} du.$$

If $k = 0$,

$$\begin{aligned} I(\xi) &= \frac{1}{\pi} \int_{-\infty}^{\tau} \frac{\sin u}{u} du \\ &= \frac{1}{\pi} \left[\int_{-\infty}^0 \frac{\sin u}{u} du + \int_0^{\tau} \frac{\sin u}{u} du \right] \\ &= \frac{1}{2} + \frac{1}{\pi} \int_0^{\tau} \frac{\sin u}{u} du. \end{aligned} \quad (3.38)$$

When $k > 0$, we change the interval of integration in the last two steps below from $u = [k\pi, k\pi + \tau]$ to $q = [0, \tau]$ by the transformation $q = u - k\pi$

$$\begin{aligned} I(\xi) &= \frac{1}{\pi} \int_{-\infty}^{k\pi+\tau} \frac{\sin u}{u} du \\ &= \frac{1}{\pi} \left[\int_{-\infty}^0 \frac{\sin u}{u} du + \int_0^{k\pi+\tau} \frac{\sin u}{u} du \right] \\ &= \frac{1}{\pi} \left[\frac{\pi}{2} + \int_0^{k\pi} \frac{\sin u}{u} du + \int_{k\pi}^{k\pi+\tau} \frac{\sin u}{u} du \right] \\ &= \frac{1}{2} + \sigma_k + \frac{1}{\pi} \int_0^{\tau} \frac{\sin(k\pi + q)}{k\pi + q} dq \\ &= \frac{1}{2} + \sigma_k + \frac{(-1)^k}{\pi} \int_0^{\tau} \frac{\sin q}{k\pi + q} dq. \end{aligned} \quad (3.39)$$

Now substitute $u = \frac{\pi kh + th}{\pi}$ into (3.34) with $du = \frac{h}{\pi} dt$. The upper limit becomes $\xi = \frac{\pi kh + th}{\pi}$, $t = \frac{\pi(\xi - kh)}{h}$ while the lower limit remains unchanged.

$$\begin{aligned}
I(\xi) &= \frac{h}{\pi} \int_{-\infty}^{\frac{\pi(\xi-kh)}{h}} \frac{\sin \frac{\pi kh+th}{\pi}}{\pi kh+th} dt \\
&= hI \left[\pi \left(\frac{\xi - kh}{h} \right) \right].
\end{aligned}$$

Changing ξ to x gives

$$J(k, h, x) = hI \left[\pi \left(\frac{x - kh}{h} \right) \right]. \quad (3.40)$$

Using (3.32), (3.38) and (3.40), we can write

$$\begin{aligned}
\int_{-\infty}^x S(k, h, x) &= J(k, h, x) \\
&= hI \left[\pi \left(\frac{x - kh}{h} \right) \right] \\
&= h \left[\frac{1}{2} + \frac{1}{\pi} \int_0^{\frac{\pi(x-kh)}{h}} \frac{\sin u}{u} du \right] \\
&= h \left[\frac{1}{2} + \frac{1}{\pi} \text{Si} \left(\frac{\pi x - \pi kh}{h} \right) \right]. \quad (3.41)
\end{aligned}$$

Taking the absolute value of (3.41),

$$\begin{aligned}
|J(k, h, x)| &= h \left| I \left[\pi \left(\frac{x - kh}{h} \right) \right] \right| \\
&= h \left| \left[\frac{1}{2} + \frac{1}{\pi} \text{Si} \left(\frac{\pi x - \pi kh}{h} \right) \right] \right| \\
&\leq h \left(\frac{1}{2} + \frac{1}{\pi} \max_{t \in \mathbb{R}} |\text{Si}(t)| \right) \\
&= h \left(\frac{1}{2} + \frac{1}{\pi} \text{Si}(\pi) \right) \\
&\leq 1.0895h,
\end{aligned}$$

which establishes (3.33). ■

The lemma below is from Haber's paper [11].

Lemma 3.2. *Assuming that f satisfies \mathbf{A}_1 , \mathbf{A}_2 and \mathbf{A}_3 , then*

$$f(u) = \sum_{k=-\infty}^{\infty} f(kh) \operatorname{sinc}\left(\frac{u-kh}{h}\right) + \frac{\sin \frac{\pi u}{h}}{2\pi i} (R_- - R_+), \quad \forall u \in \mathbb{R}. \quad (3.42)$$

Conditions \mathbf{A}_1 and \mathbf{A}_2 are not very explanatory, because if one wants to change to the interval $(-1, 1)$ one needs simpler conditions. We integrate (3.42) with respect to u in the following manner:

$$\begin{aligned} \int_{-C}^x f(u) \, du &= \sum_{k=-\infty}^{\infty} f(kh) \int_{-C}^x \operatorname{sinc}\left(\frac{u-kh}{h}\right) \, du \\ &+ \frac{1}{2\pi i} \left\{ \int_{-C}^x \sin \frac{\pi u}{h} \int_{-\infty}^{\infty} \frac{f(v-i(c-\varepsilon))}{(v-u-i(c-\varepsilon)) \sin \frac{\pi(v-i(c-\varepsilon))}{h}} \, dv \, du \right. \\ &\left. - \int_{-C}^x \sin \frac{\pi u}{h} \int_{-\infty}^{\infty} \frac{f(v+i(c-\varepsilon))}{(v-u+i(c-\varepsilon)) \sin \frac{\pi(v+i(c-\varepsilon))}{h}} \, dv \, du \right\}, \quad (3.43) \end{aligned}$$

where

$$G_{\pm} = \int_{-C}^x \sin \frac{\pi u}{h} \int_{-\infty}^{\infty} \frac{f(v \pm i(c-\varepsilon))}{(v-u \pm i(c-\varepsilon)) \sin \frac{\pi(v \pm i(c-\varepsilon))}{h}} \, dv \, du.$$

Haber [11] points out that the interchange of integration and summation is possible by imposing the following condition on f :

\mathbf{A}_4 a constant $\alpha > 0$ exists such that for all $x \in \mathbb{R}$, $f(x) = O(e^{-\alpha|x|})$ as $|x| \rightarrow \infty$.

The order of integration in G_{\pm} can be exchanged, since

$$\int_{-\infty}^{-B} \frac{f(v \pm i(c-\varepsilon)) \, dv}{(v-u \pm i(c-\varepsilon)) \sin \frac{\pi(v \pm i(c-\varepsilon))}{h}}$$

tends to zero as $B \rightarrow \infty$, uniformly for $u \in [-C, x]$. The same holds for the integral

from B to ∞ . The inner integral that is left

$$\int_{-C}^x \frac{\sin \frac{\pi u}{h} du}{v - u \pm i(c - \varepsilon)} = O(h).$$

uniformly on C , v , u and ε . We can deduce from other identities already encountered that ¹

$$\begin{aligned} \left| \sin \frac{\pi(v \pm i(c - \varepsilon))}{h} \right| &\geq \sinh \frac{\pi(c - \varepsilon)}{h} \\ &\geq \frac{1}{2} e^{\frac{\pi(c - \varepsilon)}{h}}, \end{aligned}$$

and then

$$|G_{\pm}| \leq K h e^{-\frac{\pi(c - \varepsilon)}{h}} \int_{-\infty}^{\infty} |f(v \pm i(c - \varepsilon))| dv.$$

If C is allowed to tend to infinity and ε to zero in (3.43), using (3.41) and (3.40),

$$\int_{-\infty}^x f(u) du = h \sum_{k=-\infty}^{\infty} f(kh) \left(\frac{1}{2} + \frac{1}{\pi} \text{Si} \left(\frac{\pi x - \pi kh}{h} \right) \right) + O(h e^{-\frac{\pi c}{h}}) \quad (3.44)$$

as $h \rightarrow 0$. By making use of condition \mathbf{A}_4 and the boundedness of the sine integral,

$$\begin{aligned} \int_{-\infty}^x f(u) du &= h \sum_{k=-N}^N f(kh) \left(\frac{1}{2} + \frac{1}{\pi} \text{Si} \left(\frac{\pi x - \pi kh}{h} \right) \right) \\ &\quad + O(h e^{-\frac{\pi c}{h}}) + O(e^{-\alpha N h} / h), \end{aligned} \quad (3.45)$$

as $h \rightarrow 0$ and $Nh \rightarrow \infty$. To obtain the step size h , we equate the magnitude of the O terms as follows:

$$\exp(-\pi c/h) = \exp(-\alpha N h).$$

¹If x and y are real, then $|\sin(x + iy)| = [\sinh^2 y + \sin^2 x]^{\frac{1}{2}} \geq \sinh |y|$ [25].

Taking the logarithm of both sides, we have

$$h = \sqrt{\frac{\pi c}{\alpha N}}. \quad (3.46)$$

The next theorem summarises what we have done so far. The statement of this was given in [11] without a proof.

Theorem 3.5. *If f satisfies \mathbf{A}_1 , \mathbf{A}_2 , \mathbf{A}_3 and \mathbf{A}_4 , and $h = \sqrt{\frac{\pi c}{\alpha N}}$, then*

$$\int_{-\infty}^x f(u) \, du = h \sum_{k=-\infty}^{\infty} f(kh) \left(\frac{1}{2} + \frac{1}{\pi} \text{Si} \left(\frac{\pi x - \pi kh}{h} \right) \right) + O(\sqrt{N} e^{-\sqrt{\pi c \alpha N}}), \quad (3.47)$$

as $N \rightarrow \infty$ uniformly for $x \in \mathbb{R}$.

3.4 Transformation Via Conformal Mapping

The bulk of this section will be devoted to transforming the interval in (3.47) from $(-\infty, x]$ to $(-1, 1)$, using conformal mapping. In addition, we shall end up with the analysis given by Haber in [11] to derive his formula A .

3.4.1 Approximation over $(-1, 1)$

Let $\phi : (-\infty, \infty) \mapsto (-1, 1)$ and $\psi : (-1, 1) \mapsto (-\infty, \infty)$ such that

$$w = \phi(z) = \tanh \frac{z}{2}, \quad z = \phi^{-1}(w) = \psi(w). \quad (3.48)$$

It follows from the exponential form of $\tanh z$ that

$$\tanh \frac{z}{2} = \frac{e^{\frac{z}{2}} - e^{-\frac{z}{2}}}{e^{\frac{z}{2}} + e^{-\frac{z}{2}}} = w.$$

Cross-multiplying and making z the subject of the formula gives

$$\psi(w) = z = \log \left(\frac{w+1}{1-w} \right), \quad \psi'(w) = \frac{2}{1-w^2}. \quad (3.49)$$

We define the domain as given in [19] for $\rho \in (0, \frac{\pi}{2}]$ by

$$\begin{aligned} D = & [\{z : |z + i \cot \rho| < \operatorname{cosec} \rho\}] \cap [\{z : x + iy, y \geq 0\}] \\ & \cup [\{z : |z - i \cot \rho| < \operatorname{cosec} \rho\}] \cap [\{z : x + iy, y \leq 0\}]. \end{aligned} \quad (3.50)$$

Furthermore, Lunding and Stenger [19] considered

$$\Gamma = \{z \in D : \psi(z) \in (-\infty, \infty)\} = \{x : -1 \leq x \leq 1\}, \quad (3.51)$$

and

$$g(x) = (1 - x^2)^\beta, \quad \beta \geq 0, \quad (3.52)$$

which are very useful in understanding Haber's analysis.

Our next theorem is found in [19] and gives a clear picture of g used in Haber's conditions \mathbf{A}'_1 , \mathbf{A}'_2 , \mathbf{A}'_3 and \mathbf{A}'_5 which we will encounter shortly. The proof of this is based on the lemmas preceding it. However, we do not intend to prove all the lemmas leading to the proof, but shall use the statement and figure in the theorem and prove the most cogent lemmas.

Theorem 3.6. *Let ψ be as in (3.49), s a positive integer, g as defined in (3.52), with $\beta \geq s$. Assume $\frac{f\psi'}{g} \in B(D)$, where D is the shaded region in Figure (3.2), $B(D)$ is the family of all functions which are analytic in D , and there exists positive constants K, α such that, for all $x \in [-1, 1]$,*

$$|f(x)/g(x)| \leq K(1 - x^2)^\alpha. \quad (3.53)$$

Let N be a positive integer, $h = \sqrt{\pi c / \alpha N}$, and

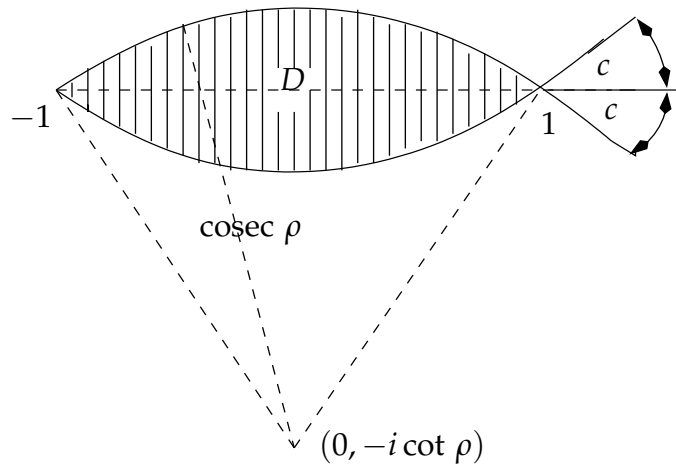
Figure 3.2: The region D from [19] and [26].

$$x_k = \tanh \frac{kh}{2}, \quad k \in \mathbb{Z}. \quad (3.54)$$

If $f^{(n)}$ exist on $[-1, 1]$, then

$$|f^{(n)}(x) - C(N, f, g, \psi, h, x)^{(n)}| \leq KN^{\frac{n+1}{2}} e^{-\sqrt{\pi c \alpha N}}, \quad (3.55)$$

holds for all $x \in [-1, 1]$ and for $n = 0, \dots, s$, where K is a constant depending on s, ρ, f and α .

Lemma 3.3. Let g be as defined in (3.52), and β a positive integer. If i is any positive integer, there exists a constant K depending on β and i , such that, for all $x \in (-1, 1)$,

$$|g^{(i)}(x)| \leq K(1 - x^2)^{\beta-i}. \quad (3.56)$$

Proof: Applying Leibnitz's rule to (3.52),

$$\begin{aligned} g^{(i)}(x) &= \frac{d^i}{dx^i} (1 - x^2)^\beta = \sum_{k=0}^i \binom{i}{k} [(1+x)^\beta]^{(k)} [(1-x)^\beta]^{(i-k)} \\ &= \sum_{k=0}^i \binom{i}{k} (-1)^k \beta(\beta-1) \cdots (\beta-k+1) (1+x)^{\beta-k} \\ &\quad \times \beta(\beta-1) \cdots (\beta-i+k+1) (1-x)^{\beta-i+k}; \end{aligned}$$

but for $x \in [-1, 1]$, $|1 + x| \leq 2$, $|1 - x| \leq 2$ and for $0 \leq k \leq i$,

$$\begin{aligned} (1+x)^{\beta-k}(1-x)^{\beta-i+k} &= \frac{(1-x^2)^{\beta-i}(1-x)^k(1+x)^i}{(1+x)^k} \\ &\leq 2^i(1-x^2)^{\beta-i}, \end{aligned}$$

and

$$\begin{aligned} |g^{(i)}(x)| &\leq \sum_{k=0}^i \binom{i}{k} 2^i |\beta(\beta-1)\cdots(\beta-k+1)| |\beta(\beta-1)\cdots(\beta-i+k+1)| \\ &\quad \times (1-x^2)^{\beta-i} \\ &\leq K(1-x^2)^{\beta-i}. \end{aligned}$$

■

Lemma 3.4. Let i, k be positive integers with $i \geq k$ and $\psi(x) = \log\left(\frac{1+x}{1-x}\right)$. Then, for all $x \in (-1, 1)$,

$$|\psi^{(i)}(x)[\psi'(x)]^{k-i}| \leq K(1-x^2)^{-k}, \quad (3.57)$$

where K is a constant depending only on i and k .

Proof: We use (3.49) with

$$\psi'(x) = \frac{2}{1-x^2} = \frac{1}{1-x} + \frac{1}{1+x}.$$

Further,

$$[\psi'(x)]^i = \frac{2^i}{(1-x)^i(1+x)^i},$$

for $i \geq 1$

$$\psi^i(x) = \left[\frac{(-1)^{i-1}}{(1+x)^i} + \frac{1}{(1-x)^i} \right] (i-1)!,$$

so that

$$\frac{\psi^{(i)}(x)}{[\psi'(x)]^i} = \frac{(i-1)!}{2^i} \left[(-1)^{i-1} (1-x)^i + (1+x)^i \right].$$

By taking the absolute value of the above, bearing in mind that $|1-x| \leq 2$, $|1+x| \leq 2$ on $[-1, 1]$ and $\psi'(x) > 0$ for all $x \in (-1, 1)$,

$$|\psi^{(i)}(x)| \leq 2(i-1)! [\psi'(x)]^i.$$

By multiplying both sides of the above inequality with $[\psi'(x)]^{k-i}$, we obtain (3.57).

■

Next we proceed to Haber's analysis. Taking $z = x + iy$, and $w = t + iv$, ϕ maps the entire $-\infty < x < \infty$ monotonically to $-1 < t < 1$. With $y = \rho$ for $-\pi < \rho < \pi$, each horizontal line is now a circular arc going from $w = -1$, through $w = i \tan \frac{\rho}{2}$ to $w = +1$ (see Figure 3.2 and Appendix A).

It is part of a circle with centre at $(0, -i \cot \rho)$ and radius $\operatorname{cosec} \rho$. Haber [11] states that a vertical line segment $z = x + iy$, $-\rho < y < \rho$, ($\rho < \pi$) becomes a circular arc of which the centre and radius are

$$\frac{e^{2x} + 1}{e^{2x} - 1} \operatorname{sgn}(x) \quad \text{and} \quad \frac{2}{e^x - e^{-x}} \operatorname{sgn}(x), \quad (3.58)$$

respectively, while from [4]

$$\operatorname{sgn}(x) = \begin{cases} -1, & \text{if } x < 0; \\ 0, & \text{if } x = 0; \\ 1, & \text{if } x > 0. \end{cases} \quad (3.59)$$

The strip $|y| < c$ ($c < \pi$) is mapped conformally to Φ_c , whose boundary is made up of two circular arcs that are the images of the lines $|y| = c$. The vertical width of

Φ_c is $2 \tan \frac{c}{2}$, $\Phi_{\frac{\pi}{2}}$ is the unit disk and Φ_{π} is the whole w -plane $(-\infty, -1) \cup (1, \infty)$ on the t axis.

Using the change of variables $t = \phi(u)$, and subsequently $-1 = \phi(-\infty)$, $v = \phi(x)$, $x = \phi^{-1}(v) = \log \left(\frac{1+v}{1-v} \right)$, we can write

$$\int_{-\infty}^x f(u) du = \int_{-1}^v g(t) dt, \quad (3.60)$$

and using $f(u) = g(\phi(u))\phi'(u)$:

$$\int_{-\infty}^x f(u) du = \int_{-1}^v g(t) dt = \int_{-\infty}^{\phi^{-1}(x)} g(\phi(u))\phi'(u) du,$$

so that Haber's formula A from (3.47) becomes

$$\begin{aligned} \int_{-1}^v g(u) du &= h \sum_{k=-N}^N g(\phi(kh))\phi'(kh) \left(\frac{1}{2} + \frac{1}{\pi} \text{Si} \left(\frac{\pi\phi^{-1}(v) - \pi kh}{h} \right) \right) \\ &+ O(\sqrt{N}e^{-\sqrt{\pi c \alpha N}}). \end{aligned} \quad (3.61)$$

Haber's conditions H_1 and H_4 , which are the same as our own \mathbf{A}_1 and \mathbf{A}_4 , can be translated into the conditions

\mathbf{A}'_1 g is analytic on Φ_c .

and

\mathbf{A}'_4 there is a constant $\alpha > 0$ such that for $t \in \mathbb{R}$, $g(t) = O((1-t^2)^{\alpha-1})$ as $t \rightarrow -1$ and $t \rightarrow +1$ from inside $(-1, 1)$.

Furthermore, we can write the integral in condition \mathbf{A}_3 as

$$\int_{L_{x,\varepsilon}} |g(w) dw|,$$

where $L_{x,\varepsilon}$ is the image of the line segment $z = x + iy$, $|y| < c - \varepsilon$ under ϕ . From (3.58) it is an arc of a circle whose radius and centre are $2e^{-|x|} + O(e^{-2|x|})$ and $\pm 1 + O(e^{-2|x|})$ respectively. As w tends to ± 1 from inside Φ_c , if we require of g that $g(w) = O(|1 - w^2|^{-1})$ as $w \rightarrow \pm 1$, then \mathbf{A}_3 would be satisfied. But we shall require the stronger condition

\mathbf{A}'_3 there is a constant $\alpha > 0$ such that $g(w) = O(|1 - w^2|^{\alpha-1})$ as w tends to ± 1 from inside Φ_c .

Let M_b be the image under ϕ of the line $y = b$ and $M_{b,\beta}$, $\beta > 0$ be the part of M_b that lies outside circles of radius β and center ± 1 . With the above, we can write the integrals in \mathbf{A}_2 as

$$\int_{M_{\pm(c-\varepsilon)}} |g(w) dw|. \quad (3.62)$$

In [11], it was also assumed that

\mathbf{A}'_2 for small β , the integrals $\int_{M_{\pm(c-\varepsilon),\beta}} |g(w) dw|$ are bounded in ε for $\varepsilon \in (0, c)$.

To check whether \mathbf{A}'_2 holds for a given g in which \mathbf{A}'_1 and \mathbf{A}'_3 holds, Haber [11] considered singularities of g at points on the boundary of Φ_c except at $t = \pm 1$. In addition, if $c' > 0$ such that $c' < c$, then \mathbf{A}'_2 will hold with c' instead of c . This leads us to the next two theorems, which can be found in [11]. They summarise the above analysis and give us Haber's formula A (3.64).

Theorem 3.7. *If g is analytic in Φ_c for some positive $c \leq \pi$, and $g(w) = O(|1 - w^2|^{\alpha-1})$ for some $\alpha > 0$ as $w \rightarrow \pm 1$ from inside Φ_c , then*

$$\begin{aligned} \int_{-1}^v g(t) dt &= h \sum_{k=-N}^N g(\phi(kh)) \phi'(kh) \left(\frac{1}{2} + \frac{1}{\pi} \text{Si} \left(\frac{\pi \phi^{-1}(v) - \pi kh}{h} \right) \right) \\ &\quad + O(\sqrt{N} e^{-\sqrt{\pi c' \alpha N}}), \end{aligned} \quad (3.63)$$

holds uniformly in $[-1, 1]$, where c' is any number in $(0, c)$ and $h = \sqrt{\frac{\pi c'}{\alpha N}}$.

Theorem 3.8. *If $0 < c \leq \pi$, $\alpha > 0$, and g satisfies conditions \mathbf{A}'_1 , \mathbf{A}'_2 and \mathbf{A}'_3 , then*

$$\int_{-1}^v g(t) dt = h \sum_{k=-N}^N g(\phi(kh)) \phi'(kh) \left(\frac{1}{2} + \frac{1}{\pi} \text{Si} \left(\frac{\pi \phi^{-1}(v) - \pi kh}{h} \right) \right) + O(\sqrt{N} e^{-\sqrt{\pi c \alpha N}}), \quad (3.64)$$

holds uniformly in $[-1, 1]$.

3.5 Derivation of Haber's Formula B

The driving force behind formula B is that, instead of calculating general values of the sine integral (Si) as in formula A, we shall only use the values of $\text{Si}(k\pi)$, $k \in \mathbb{Z}$. The latter can be calculated easily, as will be shown by the numerical experiments.

Haber's formula B involves working within the context of integrals over \mathbb{R} . We start by setting

$$F(x) = \int_{-\infty}^x f(u) du, \quad (3.65)$$

and F is approximated by an interpolation formula that makes use of evaluations of F at integral multiples of h , the step size.

The formula for the interpolation can be derived from Lemma 3.2 by truncating the sum at $k = \pm N$ and bounding the remainder at the point of truncation. In (3.29), the numerator is once Lebesgue measurable on the real line, i.e. $L^1(\mathbb{R})$. As already shown in our earlier analysis in the previous section, $|u - x \pm i(c - \varepsilon)| \geq c$ which means that it is bounded away from zero and uniformly in x, u . Moreover, we have shown earlier that $|\sin \frac{\pi(v \pm i(t - \varepsilon))}{h}| \geq K e^{\frac{\pi(c - \varepsilon)}{h}}$ uniformly in x , where K does not depend on ε . So that $|R_{\pm}| = O(e^{-\frac{\pi c}{h}})$ as $h \rightarrow 0$. If we impose condition

\mathbf{A}_4 on f ,

$$f(u) = \sum_{k=-N}^N f(kh) \operatorname{sinc} \left(\frac{u - kh}{h} \right) + O(e^{-\frac{\pi c}{h}}) + O(e^{-\alpha N h} / h),$$

as $h \rightarrow 0, N \rightarrow \infty$ as in (3.45). This leads us to the next Lemma:

Lemma 3.5. *If f satisfies $\mathbf{A}_1, \mathbf{A}_2, \mathbf{A}_3$ and \mathbf{A}_4 , then*

$$f(u) = \sum_{k=-N}^N f(kh) \operatorname{sinc} \left(\frac{u - kh}{h} \right) + O(\sqrt{N} e^{-\sqrt{\pi c \alpha N}}),$$

holds uniformly on $(-\infty, \infty)$, where h is as defined in (3.46).

This motivates the next theorem from [18], which gives the norm of the error estimates.

Theorem 3.9. *Assume that $f \in \mathcal{B}^p(D_c)$, ($p = 1$ or 2), α, γ are positive constants and K is such that*

$$|f(x)| = \begin{cases} K \exp(-\alpha|x|), & x \in (-\infty, 0) \\ K \exp(-\gamma|x|), & x \in [0, \infty). \end{cases} \quad (3.66)$$

Then choose $h = \sqrt{\frac{\pi c}{\alpha N}} \leq \frac{2\pi c}{\ln 2}$ for the truncated cardinal series $C(N, f, h, x)$. Consequently,

$$\|f(x) - C(N, f, h, x)\|_{\infty} \leq K_1 \sqrt{N} \exp(-\sqrt{\pi c \alpha N}) \quad (3.67)$$

where K_1 is a constant which depends on p and c .

Proof: The proof is simple, as it uses the sum to infinity of a geometric series.

We shall start by

$$\begin{aligned}
\left| \sum_{k=-\infty}^{-(N+1)} f(kh)S(k, h, x) \right| &\leq \sum_{k=N+1}^{\infty} |f(-kh)| \\
&\leq K \sum_{k=N+1}^{\infty} e^{-\alpha kh} \\
&= K \left\{ \frac{e^{-\alpha h(N+1)}}{1 - e^{-\alpha h}} \right\} \\
&= Ke^{-\alpha Nh} \left\{ \frac{1}{e^{\alpha h} - 1} \right\} \\
&\leq \frac{K}{\alpha h} e^{-\alpha Nh}. \tag{3.68}
\end{aligned}$$

Similarly, we obtain

$$\left| \sum_{k=N+1}^{\infty} f(kh)S(k, h, x) \right| \leq \frac{K}{\gamma h} e^{-\alpha Nh}, \tag{3.69}$$

from (3.31) with the inequality for h above and taking the absolute value of (3.20), we have

$$|f(x) - C(N, f, h, x)| \leq \sum_{k=N+1}^{\infty} |f(-kh)| + \sum_{k=N+1}^{\infty} |f(kh)| + \frac{2N_p(f, D_c)}{\sqrt[\nu]{\pi c}} e^{-\pi c/h}.$$

From (3.68) and (3.69), it is easily seen that

$$\begin{aligned}
|f(x) - C(N, f, h, x)| &\leq \left[\frac{K}{\alpha} + \frac{K}{\gamma} + \frac{2N_p(f, D_c)}{\sqrt[\nu]{\pi c}} \sqrt{\frac{\pi c}{\alpha N}} \right] \sqrt{\frac{\alpha}{\pi c}} \sqrt{N} e^{-\sqrt{\pi c \alpha N}} \\
&\leq \left[\frac{K}{\alpha} + \frac{K}{\gamma} + \frac{2N_p(f, D_c)}{\sqrt[\nu]{\pi c}} \sqrt{\frac{\pi c}{\alpha}} \right] \sqrt{\frac{\alpha}{\pi c}} \sqrt{N} e^{-\sqrt{\pi c \alpha N}} \\
&\leq K_1 \sqrt{N} e^{-\sqrt{\pi c \alpha N}}.
\end{aligned}$$

■

Let $F(z)$ [11] be defined as

$$F(z) = F(x + iy) = \int_{-\infty}^x f(u) \, du + \int_0^y f(x + iv) \, dv, \quad (3.70)$$

where z is in the strip $|y| < c$. F does not satisfy \mathbf{A}_4 and this makes it impossible to apply Lemma 3.5 on it. But f satisfies \mathbf{A}_4 , $F(x) = I + O(e^{-\alpha|x|})$ as $x \rightarrow \infty$, with I defined as $I = \int_{-\infty}^{\infty} f(u) \, du$.

Let η be an auxiliary function, e.g. $\eta(z) = \frac{e^{\alpha z}}{e^{\alpha z} + 1}$, which satisfies \mathbf{A}_1 and the condition

\mathbf{A}_5 for $\alpha > 0$ as in \mathbf{A}_4 , $\eta(x) = O(e^{-\alpha|x|})$ as $x \rightarrow -\infty$ and $\eta(x) = 1 + O(e^{-\alpha|x|})$ as $x \rightarrow +\infty$.

Next, we introduce

$$F^*(z) = F(z) - I\eta(z). \quad (3.71)$$

F^* satisfies \mathbf{A}_1 and \mathbf{A}_4 . It was suggested in [11] that F^* should be made to satisfy conditions \mathbf{A}_2 , \mathbf{A}_3 and, to do this, we require that f and η' satisfy the stronger condition

\mathbf{A}_{3a} for any small $\varepsilon > 0$, the function $Y_\varepsilon(x) = \int_{\varepsilon-c}^{c-\varepsilon} |f(x + iy)| \, dy$ is bounded and $Y_\varepsilon(x) \in L(\mathbb{R})$. Furthermore, $\int_{-\infty}^{\infty} Y_\varepsilon(x) \, dx$ is bounded in ε ,

instead of \mathbf{A}_3 .

We shall show that F^* now satisfies \mathbf{A}_2 and \mathbf{A}_3 . It follows from (3.71) and (3.70)

that

$$\begin{aligned}
& \int_{-\infty}^{\infty} |F^*(x + i(c - \varepsilon))| \, dx \\
&= \int_{-\infty}^{\infty} \left| F^*(x) \, dx + \int_0^{c-\varepsilon} (f(x + iy) - I\eta'(x + iy)) \, dy \right| \, dx \\
&\leq \int_{-\infty}^{\infty} |F^*(x)| \, dx + \int_{-\infty}^{\infty} \int_0^{c-\varepsilon} |f(x + iy)| \, dy \, dx \\
&+ |I| \int_{-\infty}^{\infty} \int_0^{c-\varepsilon} |\eta'(x + iy)| \, dy \, dx.
\end{aligned}$$

An application of Lemma 3.5 to F^* leads to the Lemma below:

Lemma 3.6. *Assume that f satisfies $\mathbf{A}_1, \mathbf{A}_2, \mathbf{A}_3$ and \mathbf{A}_4 , η satisfies \mathbf{A}_1 and \mathbf{A}_5 , η' satisfies \mathbf{A}_{3a} , with h as defined in (3.46) and*

$$F(x) = \int_{-\infty}^x f(u) \, du \quad \text{and} \quad I = \int_{-\infty}^{\infty} f(u) \, du. \quad (3.72)$$

Then

$$\begin{aligned}
F(x) &= \sum_{k=-N}^N F(kh) \operatorname{sinc} \left(\frac{x - kh}{h} \right) \\
&+ I \left(\eta(x) - \sum_{k=-N}^N \eta(kh) \operatorname{sinc} \left(\frac{x - kh}{h} \right) \right) + O(\sqrt{N}e^{-\sqrt{\pi c \alpha N}}), \quad (3.73)
\end{aligned}$$

with

$$I = h \sum_{m=-N}^N f(mh).$$

Theorem 3.5 was used to replace $F(kh)$ by

$$F(kh) = \int_{-\infty}^{kh} f(u) \, du = h \sum_{m=-N}^N f(mh) \left(\frac{1}{2} + \frac{1}{\pi} \operatorname{Si}(\pi(k - m)) \right).$$

Thus, by expanding (3.73) without the big O term,

$$\begin{aligned}
F(x) &= h \sum_{k=-N}^N \sum_{m=-N}^N f(mh) \left(\frac{1}{2} + \frac{1}{\pi} \text{Si}(\pi(k-m)) \right) \text{sinc} \left(\frac{x-kh}{h} \right) \\
&+ I \left(\eta(x) - \sum_{k=-N}^N \eta(kh) \text{sinc} \left(\frac{x-kh}{h} \right) \right) \\
&= \frac{h}{2} \sum_{k=-N}^N \sum_{m=-N}^N f(mh) \text{sinc} \left(\frac{x-kh}{h} \right) \\
&+ \frac{h}{\pi} \sum_{k=-N}^N \sum_{m=-N}^N f(mh) \text{Si}(\pi(k-m)) \text{sinc} \left(\frac{x-kh}{h} \right) \\
&+ h \sum_{m=-N}^N f(mh) \left(\eta(x) - \sum_{k=-N}^N \eta(kh) \text{sinc} \left(\frac{x-kh}{h} \right) \right).
\end{aligned}$$

After collecting like terms with the help of (1.7), (3.73) now reads [11]:

Theorem 3.10. *Assume that f satisfies $\mathbf{A}_1, \mathbf{A}_2, \mathbf{A}_{3a}$ and \mathbf{A}_4 , η satisfies \mathbf{A}_1 and \mathbf{A}_5 and η' satisfies \mathbf{A}_{3a} . Then*

$$\begin{aligned}
\int_{-\infty}^x f(u) du &= h \sum_{k=-N}^N \sum_{m=-N}^N f(mh) \sigma_{k-m} \text{sinc} \left(\frac{x-kh}{h} \right) \\
&+ h \sum_{m=-N}^N f(mh) \left(\eta(x) - \sum_{k=-N}^N \left(\eta(kh) - \frac{1}{2} \right) \text{sinc} \left(\frac{x-kh}{h} \right) \right) \\
&+ O((\sqrt{N})^3 e^{-\sqrt{\pi c \alpha N}}), \tag{3.74}
\end{aligned}$$

holds uniformly for $-\infty < x < \infty$, where h is as defined in (3.46).

3.5.1 Haber's Formula B

Formula B can be derived by the change of variables $w = \phi(z) = \tan \frac{z}{2}$ and by setting $f(u) = g(\phi(u))\phi'(u)$ with $\phi(w) = \eta(\phi^{-1}(w))$. Multiplying the numerator

and denominator of η by $e^{-\alpha x}$, we will have

$$\begin{aligned}
 \varphi(w) &= \eta(\psi(w)) \\
 &= \eta\left(\log\left(\frac{w+1}{1-w}\right)\right) \\
 &= \frac{1}{1 + \exp\left(-\alpha \log\left(\frac{w+1}{1-w}\right)\right)} \\
 &= \frac{1}{1 + \left(\frac{1-w}{w+1}\right)^\alpha} \\
 &= \frac{(w+1)^\alpha}{(w+1)^\alpha + (1-w)^\alpha}.
 \end{aligned}$$

It follows from our previous analysis that conditions \mathbf{A}'_1 and \mathbf{A}'_3 on g imply \mathbf{A}_2 , \mathbf{A}_{3a} and \mathbf{A}_4 on f , while \mathbf{A}'_1 on η is equivalent to \mathbf{A}_1 on f . Consequently, \mathbf{A}'_1 on φ is the same as condition \mathbf{A}_1 on η . The condition \mathbf{A}_5 on η holds if we require that

$$\mathbf{A}'_5 \quad \varphi \text{ is continuous on } [-1, 1] \text{ and } \varphi(-1) = 0, \varphi(1) = 1.$$

In addition, φ satisfies a Hölder condition on $[-1, 1]$ of order α .

For \mathbf{A}_{3a} to hold on η , Haber imposed \mathbf{A}'_3 on φ' ; conditions \mathbf{A}'_3 for φ' and \mathbf{A}'_5 for φ imply the Hölder condition for φ . We conclude with this theorem from [11].

Theorem 3.11. *If $0 < c \leq \pi$, $\alpha > 0$, g satisfies conditions \mathbf{A}'_1 , \mathbf{A}'_2 and \mathbf{A}'_3 , φ satisfies \mathbf{A}'_1 and \mathbf{A}'_5 , and η' satisfies \mathbf{A}_3 . Then (3.75) holds uniformly in $[-1, 1]$, and I^* is defined by (3.76).*

A close look at \mathbf{A}'_5 and the choice of the functions $\varphi = \frac{w+1}{2}$ satisfies the conditions for all c and for any $\alpha \leq 1$, and the function $\varphi = \frac{-w^3 + 3w + 2}{4}$ satisfies the conditions for all c for any $\alpha \leq 2$, since $\varphi'(-1) = \varphi'(1) = 0$. To avoid the condition \mathbf{A}'_2 , Haber states that we should replace c' by c in the error term. He presents this in the form of a theorem, which is Haber's formula B.

Theorem 3.12. *If $0 < c \leq \pi$, $\alpha > 0$ and*

1. g is analytic in Φ_c and $g(w) = O(|1 - w^2|^{\alpha-1})$ as $w \rightarrow \pm 1$ from the interior or inside Φ_c ;
2. φ is analytic in Φ_c and $\varphi(-1) = 0$, $\varphi(1) = 1$; $\varphi'(w) = O(|1 - w^2|^{\alpha-1})$ as $w \rightarrow \pm 1$ from inside Φ_c ,

then

$$\begin{aligned} \int_{-1}^v g(t) dt &= h \sum_{k=-N}^N \sum_{m=-N}^N g(\phi(mh)) \phi'(mh) \sigma_{k-m} \operatorname{sinc} \left(\frac{\phi^{-1}(v) - kh}{h} \right) \\ &+ I^* \left(\varphi(v) - \sum_{k=-N}^N \left(\varphi(\phi(kh)) - \frac{1}{2} \right) \operatorname{sinc} \left(\frac{\phi^{-1}(v) - kh}{h} \right) \right) \\ &+ O((\sqrt{N})^3 e^{-\sqrt{\pi c \alpha N}}), \end{aligned} \quad (3.75)$$

holds uniformly on $[-1, 1]$, $c' \in (0, c)$, $h = \sqrt{\frac{\pi c'}{\alpha N}}$ and

$$I^* = h \sum_{m=-N}^N g(\phi(mh)) \phi'(mh). \quad (3.76)$$

If $\int_{-1}^1 g(t) dt = 0$, then I^* may be replaced by zero.

3.6 Computational Considerations

We shall consider two cases for the computation of the double sum in (3.75)-on the one hand for a single value of v and on the other hand for several values.

The double sum in (3.75) involves computing $2N + 1$ values of sine in the sinc function, but because k is an integer we can simplify matters.

$$\begin{aligned} \operatorname{sinc} \left(\frac{\phi^{-1}(v) - kh}{h} \right) &= \frac{h \sin \left(\frac{\pi \phi^{-1}(v)}{h} - \pi k \right)}{\pi \phi^{-1}(v) - \pi kh} \\ &= \frac{h (-1)^k \sin \frac{\pi \phi^{-1}(v)}{h}}{\pi \phi^{-1}(v) - kh} \end{aligned}$$

Thus, we can write

$$\begin{aligned} & h \sum_{k=-N}^N \sum_{m=-N}^N g(\phi(mh)) \phi'(mh) \sigma_{k-m} \operatorname{sinc}\left(\frac{\phi^{-1}(v) - kh}{h}\right) \\ &= \frac{h^2}{\pi} \sin \frac{\pi \phi^{-1}(v)}{h} \sum_{k=-N}^N \sum_{m=-N}^N \frac{(-1)^k \sigma_{k-m}}{\phi^{-1}(v) - kh} g(\phi(mh)) \phi'(mh), \end{aligned} \quad (3.77)$$

which uses only one sine evaluation. It follows that (3.75) involves more calculation than (3.63) because of the double sum. If we are to approximate the integral for many values of v , we write the double sum as

$$\frac{h^2}{\pi} \sin \frac{\pi \phi^{-1}(v)}{h} \sum_{k=-N}^N \frac{Z_k}{\phi^{-1}(v) - kh}, \quad (3.78)$$

where

$$Z_k = \sum_{m=-N}^N (-1)^k \sigma_{k-m} g(\phi(mh)) \phi'(mh). \quad (3.79)$$

The Z_k are independent of v , which allows us to calculate Z_k first before each new value of v , which requires the calculation of a single sum. The simplification makes Haber's formula B faster than A when several values of the indefinite integral are needed. It should also be noted that each value of v requires only a sine, a logarithm and two simple sums for B , and $2N + 1$ new values of the sine integral for A .

However, developments in software has circumvented the above simplifications, since sinc values can be computed easily by typing `sinc(x)` in Matlab[®] or octave.

One thing that is noteworthy is that the parameters α and c have to be chosen to "normalise" the functions in such a way that,

$$\int_{-1}^1 |g(t)| dt = 1. \quad (3.80)$$

It also becomes clear as remarked in Haber ([10], p. 148, [11]) that most of the abscissas $\phi(kh)$ are very close to ± 1 because, as $|kh| \rightarrow \infty$,

$$\tanh \frac{kh}{2} = \pm 1 + O(e^{-|kh|}). \quad (3.81)$$

It might not be possible to evaluate integrands that contain factors such as $(1 - x)$, because the integrand may be infinite at ± 1 . This computational pitfall can be avoided by studying the function $\phi'(x)f(\phi(x))$.

Chapter 4

Indefinite Integration on $(-\infty, \infty)$

For the Lord gives wisdom, and from His mouth come knowledge and understanding.

Proverbs 2:6.

This chapter shall be devoted to the derivation of the quadrature formulas given by Tanaka *et al.* in [32]. The formulas will be derived on the basis of error analysis. One of the formulas is based on Stenger's [27] Single Exponential (SE) transformation, and the other is based on the Double Exponential (DE) transformation of Takahasi and Mori [31]. We introduce the function spaces $\mathbf{H}^\infty(D_c, \omega)$ and give some important results with a view to obtaining an expression for the step size of Tanaka *et al.*'s [32] DE sinc method.

4.1 Stenger's SE Formula

Before proceeding to the derivation of Stenger's SE formula, a definition is provided of single exponential transformation and the family of analytic functions $\mathbf{L}_\alpha(\mathcal{D}_c)$ and $\mathbf{M}_\alpha(\mathcal{D}_c)$ are introduced.

Definition 4.1. (*Single Exponential Transformation*) A function f is said to decay

single exponentially [22] with respect to the conformal map ϕ (as in Chapter 3), if there exist positive constants α and K such that

$$|f(\phi(x))\phi'(x)| \leq K \exp(-\alpha|x|) \text{ for all } x \in \mathbb{R}, \quad (4.1)$$

and any ϕ that satisfies (4.1) is called a single exponential transformation.

Definition 4.2. Let α, β be positive numbers, and $\mathbf{L}_{\alpha,\beta}(\mathcal{D}_c)$ denote the family of functions f that are analytic in \mathcal{D}_c [27], such that for some constants $K > 0$, and all $z \in \mathcal{D}_c$, we have

$$|f(z)| \leq K \frac{e^{\alpha z}}{(1 + |e^z|)^{\alpha+\beta}}. \quad (4.2)$$

Let $\alpha \in (0, 1], \beta \in (0, 1], c \in (0, \pi)$, and $\mathbf{M}_{\alpha,\beta}(\mathcal{D}_c)$ denote the family of functions in which v is holomorphic in \mathcal{D}_c , which has finite limits at a and b [28], such that $f \in \mathbf{L}_{\alpha,\beta}(\mathcal{D}_c)$, where f is defined by

$$f = v - \ell v, \quad (4.3)$$

and

$$\ell v(z) = \frac{v(a) + e^{\phi(z)}v(b)}{1 + e^{\phi(z)}}. \quad (4.4)$$

Stenger ([28], p. 383, 387) suggests that, in approximating integrals over various intervals, one should select a mapping ϕ that gives a one-to-one transformation of (a, b) onto the real line and that provides a conformal mapping of the region \mathcal{D} on which the integrand is analytic onto \mathcal{D}_c . He also illustrates that for problems that involve approximating functions that decay exponentially in at least one of the points at $\pm\infty$, we take $\phi(z) = z$, so that (4.3) reduces to

$$f(x) = v(x) - \frac{[v(-\infty) + e^x v(\infty)]}{(1 + e^x)}, \quad (4.5)$$

by replacing z with x .

Remark 4.1. For the sake of notation, we shall write $\mathbf{L}_\alpha(\mathcal{D}_c)$ for $\mathbf{L}_{\alpha,\alpha}(\mathcal{D}_c)$ and $\mathbf{M}_\alpha(\mathcal{D}_c)$ for $\mathbf{M}_{\alpha,\alpha}(\mathcal{D}_c)$.

For all real x , after simplifying (4.2) we have

$$\frac{1}{2^{2\alpha}} e^{-\alpha|x|} \leq \frac{e^{\alpha x}}{(1 + e^{\alpha x})^{2\alpha}} \leq e^{-\alpha|x|}. \quad (4.6)$$

Let α', c' be positive numbers, and f a given function. Throughout this section, our assumption is that $f \in \mathbf{L}_{\alpha'}(\mathcal{D}_{c'})$.

Define v, V for $\tau > 0$ by

$$\begin{aligned} v(z) &= f(z) - \frac{\tau}{2 \cosh^2(\tau z)} \int_{-\infty}^{\infty} f(u) \, du, \\ &= f(z) - \frac{\tau}{2} \operatorname{sech}^2(\tau z) \int_{-\infty}^{\infty} f(u) \, du, \end{aligned} \quad (4.7)$$

where $V(z) = \int_{-\infty}^z v(t) \, dt$. Integrating $\frac{\tau}{2} \operatorname{sech}^2(\tau t)$ with respect to t and using the exponential forms of \tanh ,

$$\begin{aligned} \frac{\tau}{2} \int_{-\infty}^z \operatorname{sech}^2(\tau t) \, dt &= \frac{1}{2} \tanh(\tau t) \Big|_{-\infty}^z \\ &= \frac{e^{2\tau z}}{e^{2\tau z} + 1} \\ &= \frac{e^{\tau z}}{e^{\tau z} + e^{-\tau z}} \\ &= \frac{e^{\tau z}}{2 \cosh(\tau z)}, \end{aligned}$$

from which we arrive at

$$V(z) = \int_{-\infty}^z f(u) \, du - \frac{e^{\tau z}}{2 \cosh(\tau z)} \int_{-\infty}^{\infty} f(u) \, du. \quad (4.8)$$

Stenger [27] points out that we set

$$c = \min\left(c', \frac{\pi}{2\tau} - \varepsilon\right), \quad \alpha = \min(\alpha', \tau), \quad (4.9)$$

with $\varepsilon \in (0, \frac{\pi}{2\tau})$, but otherwise ε is an arbitrary positive number.

Next we shall define some important operators used for indefinite integration and the sinc interpolation. The definition below is from [32] (p. 657).

Definition 4.3. For a function f defined on a complex region containing the real line, we define the following operators

$$\mathcal{I}(v, z) = \int_{-\infty}^z v(u) \, du, \quad (4.10)$$

$$C(N, h, v, z) = \sum_{k=-N}^N v(kh) S(k, h, z), \quad (4.11)$$

$$C(v, h, z) = \lim_{N \rightarrow \infty} C(N, h, v, z), \quad (4.12)$$

$N \in \mathbb{Z}$, $h \in \mathbb{R}$, N and h are positive.

The series of Lemmas about to be stated and proved are important in order to understand the proof of the main result for the Single Exponential formula given by Tanaka *et al.* [32].

For the proof of the first two Lemmas, we make the following preliminary remark: since $\alpha \in (0, \alpha')$, then for all $x \in \mathbb{R}$, we have

$$\frac{e^{\alpha'x}}{(1 + e^x)^{2\alpha'}} \leq \frac{e^{\alpha x}}{(1 + e^x)^{2\alpha}}. \quad (4.13)$$

Lemma 4.1. Let f satisfy the conditions of Theorem 4.1, v and V be as defined in (4.7) and (4.8) respectively. Then v and V belong to $\mathbf{L}_\alpha(\mathcal{D}_c)$.

Proof: First, we set out to prove that $v \in \mathbf{L}_\alpha(\mathcal{D}_c)$. To do this, we have

$\frac{\tau}{2 \cosh^2(\tau z)} \int_{-\infty}^{\infty} f(u) \, du \in \mathbf{L}_\alpha(\mathcal{D}_c)$ from the statement of Theorem 4.1, $f \in \mathbf{L}_\alpha(\mathcal{D}_c)$ and from (4.7), (4.9). This shows that $v \in \mathbf{L}_\alpha(\mathcal{D}_c)$. With V as defined in (4.8), it is holomorphic¹ on \mathcal{D}_c . Since $f \in \mathbf{L}_\alpha(\mathcal{D}_c)$, $z \in \mathcal{D}_c$ with $\Re z = x$, from (4.6) it can be deduced that $f(x + iy) \leq Ke^{-\alpha|x|}$ and

$$\begin{aligned} \left| \int_{-\infty}^{\infty} f(u) \, du \right| &\leq \left| K \int_{-\infty}^{\infty} e^{-\alpha|u|} \, du \right| \\ &= \frac{2K}{\alpha} e^{-\alpha|u|} \Big|_0^\infty \\ &= \frac{2K}{\alpha}. \end{aligned}$$

Assuming that $x \leq 0$, since $\int_{-\infty}^{\infty} f(u) \, du$ does not depend on the path for any remaining path on \mathcal{D}_c , let us choose a path depending on a positive number L , $L > -x$. The path will be divided into three: the first, from $-\infty$ to $-L$, the second a vertical line segment from $-L$ to $-L + iy$ and, lastly, a horizontal line segment from $-L + iy$ to $x + iy$.

Let us use (4.6) to evaluate $\int_{-\infty}^z f(u) \, du$ thus:

$$\left| \int_{-\infty}^z f(u) \, du \right| \leq \left| \int_{-\infty}^{-L} f(u) \, du \right| + \left| \int_{-L}^{-L+iy} f(u) \, du \right| + \left| \int_{-L+iy}^{x+iy} f(u) \, du \right|.$$

Starting with

$$\begin{aligned} \left| \int_{-\infty}^{-L} f(u) \, du \right| &\leq \left| \int_{-\infty}^{-L} Ke^{-\alpha|u|} \, du \right| \\ &= K \int_{-\infty}^{-L} e^{\alpha u} \, du \\ &= \frac{K}{\alpha} e^{-\alpha L}, \end{aligned}$$

¹synonymous with analytic

we find that

$$\begin{aligned} \left| \int_{-L}^{-L+iy} f(u) \, du \right| &\leq \left| \int_{-L}^{-L+iy} |f(u)| \, du \right| \\ &\leq |iy| \max_{u \in [-L, -L+iy]} |f(u)| \\ &= K|y|e^{-\alpha L}, \end{aligned}$$

and

$$\begin{aligned} \left| \int_{-L+iy}^{x+iy} f(u) \, du \right| &\leq K \left| \int_{-L+iy}^{x+iy} e^{-\alpha|u|} \, du \right| \\ &\leq K \left| \int_{-L+iy}^{x+iy} e^{-\alpha|x|} \, dx \right| \\ &= \frac{K}{\alpha} (e^{-\alpha|x|} - e^{-\alpha L}), \end{aligned}$$

so that

$$\left| \int_{-\infty}^z f(u) \, du \right| \leq \frac{K}{\alpha} e^{-\alpha L} + K|y|e^{-\alpha L} + \frac{K}{\alpha} (e^{-\alpha|x|} - e^{-\alpha L}).$$

By letting L tend to ∞ , $\left| \int_{-\infty}^z f(u) \, du \right| \leq \frac{K}{\alpha} e^{-\alpha|x|}$.

Let $z = x + iy \in \mathcal{D}_c$, $\Re z = x \leq 0$ and $\Im z = y$, and using the exponential form of $\cosh(\tau z)$, i.e. $\cosh(\tau z) = (e^{\tau z} + e^{-\tau z})/2$ after some algebra using the identities $\cosh(ix) = \cos x$ and $\sinh(ix) = i \sin x$.

$$\begin{aligned} \left| \frac{e^{\tau z}}{\cosh(\tau z)} \right| &= \frac{2e^{2\tau x}}{\sqrt{(e^{2\tau x} - 1)^2 + 4e^{2\tau x} \cos^2(\tau y)}} \\ &\leq \frac{2e^{2\tau z}}{2e^{\tau x} \cos(\tau y)} \\ &= \frac{e^{\tau z}}{\cos(\tau y)} \\ &\leq \frac{e^{\alpha x}}{\sin(\alpha \varepsilon)} \end{aligned}$$

since $0 < \alpha \leq \tau$ and $|y| < c \leq \frac{\pi}{2\tau} - \varepsilon < \frac{\pi}{2\tau}$. Then, from (4.8) and the left-hand

side of (4.6) we have

$$\begin{aligned} |V(z)| &\leq \frac{K}{\alpha} e^{-\alpha|x|} + \frac{K}{\alpha} \frac{e^{\alpha x}}{\sin(\alpha\varepsilon)} \\ &\leq \frac{K}{\alpha} \left(1 + \frac{1}{\sin(\alpha\varepsilon)}\right) e^{-\alpha|x|} \\ &\leq \frac{2K}{\alpha} \left(1 + \frac{1}{\sin(\alpha\varepsilon)}\right) \frac{e^{-\alpha|x|}}{(1+e^x)^{2\alpha}}. \end{aligned}$$

This shows that $V(z) \in \mathbf{L}_\alpha(\mathcal{D}_c)$ and thus completes the proof. ■

We shall state the Lemma below, the proof of which can be found in [26] and the result of which will be used in the proof of the Lemma following it.

Lemma 4.2. *If $\beta, u, \zeta \in \mathbb{R}$, $\beta \neq 0$ and*

$$w(h, u, \beta, \zeta) = \frac{1}{2\pi i} \int_{-\infty}^{\zeta} \frac{\sin(\pi x/h) dx}{u - x - i\beta}, \quad (4.14)$$

then

$$|w(h, u, \beta, \zeta)| \leq \frac{h}{4|\beta|}. \quad (4.15)$$

The following result then holds.

Lemma 4.3. *Let $w(h, u, \beta, \zeta)$ be as defined in (4.14). If we let*

$$\delta(v, h, x) = \int_{-\infty}^x \left\{ v(u) - \sum_{k=-N}^N v(kh) S(k, h, u) \right\} du, \quad (4.16)$$

then for every $x \in \mathbb{R}$

$$\delta(v, h, x) = \int_{-\infty}^{\infty} \left\{ \frac{w(h, u, c, x)v(u - ic^-)}{\sin[\pi(u - ic)/h]} - \frac{w(h, u, -c, x)v(u + ic^-)}{\sin[\pi(u - ic)/h]} \right\} du. \quad (4.17)$$

Moreover, if $N_1(v, \mathcal{D}_c)$ is as defined in (3.19), then for $x \in \mathbb{R}$,

$$|\delta(v, h, x)| \leq \frac{hN_1(v, \mathcal{D}_c)}{4c \sinh(\pi c/h)}. \quad (4.18)$$

Proof: We can deduce from Lemma 4.1 that $v \in \mathbf{L}_\alpha(\mathcal{D}_c)$ and $v \in \mathcal{B}(\mathcal{D}_c)$. Borrowing a cue from (3.20),

$$\begin{aligned} \delta(v, h, x) &= \int_{-\infty}^x \frac{\sin(\pi z/h)}{2\pi i} \int_{-\infty}^{\infty} \left\{ \frac{v(u - ic^-)}{(u - z - ic) \sin[\pi(u - ic)/h]} \right. \\ &\quad \left. - \frac{v(u + ic^-)}{(u - z + ic) \sin[\pi(u + ic)/h]} \right\} du dz \\ &= \frac{1}{2\pi i} \left\{ \int_{-\infty}^x \frac{\sin(\pi z/h) dz}{u - z - ic} \int_{-\infty}^{\infty} \frac{v(u - ic^-) du}{\sin[\pi(u - ic)/h]} \right. \\ &\quad \left. - \int_{-\infty}^x \frac{\sin(\pi z/h) dz}{u - z + ic} \int_{-\infty}^{\infty} \frac{v(u + ic^-) du}{\sin[\pi(u + ic)/h]} \right\} \\ &= \int_{-\infty}^{\infty} \left\{ \frac{w(h, u, c, x)v(u - c^-)}{\sin[\pi(u - ic)/h]} - \frac{w(h, u, -c, x)v(u + c^-)}{\sin[\pi(u + ic)/h]} \right\} du. \end{aligned}$$

Taking absolute values and using (4.15),

$$\begin{aligned} |\delta(v, h, x)| &\leq \int_{-\infty}^{\infty} \left| \frac{w(h, u, c, x)v(u - c^-)}{\sin[\pi(u - ic)/h]} \right| du + \int_{-\infty}^{\infty} \left| \frac{w(h, u, -c, x)v(u + c^-)}{\sin[\pi(u + ic)/h]} \right| du \\ &\leq \frac{h}{4|c| \sinh(\pi c/h)} \left[\int_{-\infty}^{\infty} |v(u - ic^-)| + |v(u + ic^-)| \right] du \\ &= \frac{hN_1(v, \mathcal{D}_c)}{4c \sinh(\pi c/h)}. \end{aligned}$$

■

The result below holds from [27] and it will be applied in the proof of Theorems 4.1 and 4.8.

Lemma 4.4. For the norm operator of $C(N, h)$, defined as

$$\|C(N, h)\|_\infty = \sup_{|f(x)| \leq 1} \left\{ \sup_{x \in \mathbb{R}} \left| \sum_{k=-N}^N f(kh) S(k, h, x) \right| \right\}, \quad (4.19)$$

we have

$$\begin{aligned} \|C(N, h)\|_\infty &\leq \sup_{x \in \mathbb{R}} \sum_{k=-N}^N \left| \operatorname{sinc} \left(\frac{x - kh}{h} \right) \right| \\ &\leq \frac{2(3 + \log N)}{\pi}. \end{aligned} \quad (4.20)$$

With the above results, we are now in a position to state and prove the following main result, which gives us an error for the Single Exponential formula from which we can obtain the SE formula through a variable transformation. The presentation of the proof given in this thesis is more detailed and comprehensive than the original proof given in [27].

Theorem 4.1. (Main Result) *Let $f \in \mathbf{L}_{\alpha'}(\mathcal{D}_{c'})$, let τ be a positive number with c and α as defined in (4.9), $0 < \varepsilon < \frac{\pi}{2\tau}$. Let $I(k)$ be as defined in (3.35), and h as defined in (3.46), N is a positive integer. Then there exists a positive constant K that is independent of N , such that*

$$\begin{aligned} &\sup_{x \in \mathbb{R}} \left| \int_{-\infty}^x f(u) \, du - \frac{e^{\tau x}}{2 \cosh(\tau x)} h \sum_{m=-N}^N f(mh) \right. \\ &\quad \left. - h \sum_{k=-N}^N \left\{ \sum_{m=-N}^N I(k-m) \left[f(mh) - \frac{\tau}{2 \cosh^2(\tau mh)} h \sum_{k=-N}^N f(kh) \right] \right\} S(k, h, x) \right| \\ &\leq K\sqrt{N}e^{-\sqrt{\pi c \alpha N}}. \end{aligned} \quad (4.21)$$

Proof: We shall first show, using the notations (4.7) and (4.10) to (4.12), that the following relations hold uniformly for $x \in \mathbb{R}$,

$$|\mathcal{I}(v, x) - C(N, h, \mathcal{I}(C(N, v, h, x), x), x)| \leq K\sqrt{N}e^{-\sqrt{\pi c \alpha N}}, \quad (4.22)$$

where K does not depend on N .

$$\begin{aligned} & |\mathcal{I}(v, x) - C(N, h, \mathcal{I}(C(N, v, h, x), x), x)| \\ & \leq |\mathcal{I}(v, x) - C(N, h, \mathcal{I}(v, x), x)| + |C(N, h, \mathcal{I}(v, x), x) - C(N, h, \mathcal{I}(C(v, h, x), x), x)| \\ & + |C(N, h, \mathcal{I}(C(v, h, x), x), x) - C(N, h, \mathcal{I}(C(N, v, h, x), x), x)|. \end{aligned}$$

Let $v_1(x) = \mathcal{I}(v, x) - C(N, h, \mathcal{I}(v, x), x)$,

$v_2(x) = C(N, h, \mathcal{I}(v, x), x) - C(N, h, \mathcal{I}(C(v, h, x), x), x)$ and

$v_3(x) = C(N, h, \mathcal{I}(C(v, h, x), x), x) - C(N, h, \mathcal{I}(C(N, v, h, x), x), x)$. Since $\mathcal{I}(v, x) = V$ and from Lemma 4.1 we have $V \in \mathbf{L}_\alpha(D_c)$.

Consequently, from Theorem 3.9 we obtain

$$|v_1(x)| \leq K_1 \sqrt{N} e^{-\sqrt{\pi \alpha c N}}. \quad (4.23)$$

Similarly, from Lemma 4.3

$$|\mathcal{I}(v, x) - \mathcal{I}(C(v, h, x), x)| \leq K_2 h e^{-\frac{\pi c}{h}},$$

and

$$\begin{aligned} |v_2(x)| &= |C(N, h, \mathcal{I}(v, x), x) - C(N, h, \mathcal{I}(C(v, h, x), x), x)| \\ &\leq \|C(N, h)\|_\infty \sup_{x \in \mathbb{R}} |\mathcal{I}(v, x) - \mathcal{I}(C(v, h, x), x)| \\ &\leq 2K_3 \frac{(3 + \log N)}{\pi} h e^{-\frac{\pi c}{h}} \\ &= 2K_3 \sqrt{\frac{\pi c}{\alpha N}} \frac{(3 + \log N)}{\pi} e^{-\sqrt{\pi \alpha c N}} \\ &\leq K_5 \frac{\log N}{\sqrt{N}} e^{-\sqrt{\pi \alpha c N}}, \end{aligned} \quad (4.24)$$

where K_5 does not depend on N .

To obtain an estimate for $v_3(x)$, we get $v \in \mathbf{L}_\alpha(D_c)$ from Lemma 4.1, which means that there exists a constant K_8 such that $|v(kh)| \leq K_8 e^{-\alpha|k|h}$, $k \in \mathbb{Z}$. Also, from the result of Lemma 3.1,

$$\begin{aligned}
|\mathcal{I}(C(v, h, x), x) - \mathcal{I}(C(N, v, h, x), x)| &= \left| \int_{-\infty}^x \sum_{|k|>N} v(kh) S(k, h, u) \, du \right| \\
&= \left| \sum_{|k|>N} v(kh) J(k, h, x) \right| \\
&\leq \sup_{x \in \mathbb{R}} |J(k, h, x)| \sum_{|k|>N} |v(kh)| \\
&\leq 1.1h \sum_{|k|>N} |v(kh)| \\
&\leq 1.1h K_6 \sum_{k=N+1} e^{-\alpha|k|h} \\
&= 2.2h K_6 \frac{e^{-\alpha h}}{1 - e^{-\alpha h}} e^{-\alpha N h} \\
&\leq \frac{2.2K_6}{\alpha} e^{-\alpha N h},
\end{aligned}$$

with $h = \sqrt{\frac{\pi c}{\alpha N}}$ and

$$\begin{aligned}
|v_3(x)| &= |C(N, h, \mathcal{I}(C(v, h, x), x), x) - C(N, h, \mathcal{I}(C(N, v, h, x), x), x)| \\
&\leq \|C(N, h)\|_\infty \sup_{x \in \mathbb{R}} |\mathcal{I}(C(v, h, x), x) - \mathcal{I}(C(N, v, h, x), x)| \\
&\leq \frac{4.4(3 + \log N)}{\alpha \pi} K_6 e^{-\sqrt{\pi \alpha c N}} \\
&\leq K_7 (\log N) e^{-\sqrt{\pi \alpha c N}}.
\end{aligned} \tag{4.25}$$

By adding together (4.23), (4.24) and (4.25), we obtain (4.22).

The inequality (4.22) can now be used to establish (4.21), as shown below.

$$\begin{aligned}\mathcal{I}(v, x) &= \int_{-\infty}^x f(u) \, du - \frac{e^{\tau x}}{2 \cosh(\tau x)} \int_{-\infty}^{\infty} f(u) \, du \\ &= \int_{-\infty}^x f(u) \, du - \frac{e^{\tau x} h}{2 \cosh(\tau x)} \sum_{m=-N}^N f(mh)\end{aligned}\quad (4.26)$$

also,

$$\begin{aligned}C(N, v, h, x) &= \sum_{m=-N}^N v(mh) S(m, h, x) \\ \mathcal{I}(C(N, v, h, x), x) &= \int_{-\infty}^x \sum_{m=-N}^N v(mh) S(m, h, t) \, dt\end{aligned}$$

and

$$\begin{aligned}C(N, h, \mathcal{I}(C(N, v, h, x), x), x) &= \sum_{k=-N}^N \left[\int_{-\infty}^{kh} \sum_{m=-N}^N v(mh) S(m, h, t) \, dt \right] S(k, h, x) \\ &= \sum_{k=-N}^N \left[\sum_{m=-N}^N v(mh) \int_{-\infty}^{kh} S(m, h, t) \, dt \right] S(k, h, x) \\ &= h \sum_{k=-N}^N \left[\sum_{m=-N}^N v(mh) \left\{ \frac{1}{2} + \frac{1}{\pi} \text{Si} \left(\frac{\pi kh - \pi mh}{h} \right) \right\} \right] S(k, h, x) \\ &= h \sum_{k=-N}^N \left[\sum_{m=-N}^N v(mh) \left\{ \frac{1}{2} + \frac{1}{\pi} \text{Si}(\pi(k - m)) \right\} \right] S(k, h, x) \\ &= h \sum_{k=-N}^N \left[\sum_{m=-N}^N v(mh) I(k - m) \right] S(k, h, x) \\ &= h \sum_{k=-N}^N \left[\sum_{m=-N}^N I(k - m) \left(f(mh) - \frac{\tau h}{2 \cosh^2(\tau mh)} \sum_{k=-N}^N f(kh) \right) \right] S(k, h, x),\end{aligned}\quad (4.27)$$

where

$$\begin{aligned} I(k-m) &= \frac{1}{2} + \frac{1}{\pi} \text{Si}(\pi(k-m)) \\ &= \frac{1}{2} + \int_0^{k-m} \frac{\sin \pi u}{\pi u} du. \end{aligned}$$

By subtracting equation (4.27) from (4.26) and taking the supremum over all $x \in \mathbb{R}$, we obtain (4.21). \blacksquare

It will be observed that the above result has not been transformed into $(-1, 1)$. Thus, in ways analogous to those in Chapter 3, we make the variable transformation $w = \phi(z) = \tanh \frac{z}{2}$. This paves the way for the following fundamental result from [32], which also helps us to find the parameters.

4.1.1 Finding the Parameters

Theorem 4.2. *Let α_g and c_g be positive numbers. Using the variable transformation $u = \phi(t)$, the transformed function $g(t) = f(\phi(t))\phi'(t) \in \mathbf{L}_{\alpha_g}(\mathcal{D}_{\alpha_g})$, then there exists a positive number K independent of N , such that*

$$\begin{aligned} & \sup_{-1 < x < 1} \left| \int_{-1}^x f(u) du - \left[\frac{\exp[\tau\phi^{-1}(x)]}{2 \cosh(\tau\phi^{-1}(x))} h \sum_{k=-N}^N f(\phi(kh))\phi'(kh) \right. \right. \\ & \quad \left. \left. + h \sum_{k=-N}^N \left\{ \sum_{m=-N}^N I(k-m) \left(f(\phi(mh))\phi'(mh) \right. \right. \right. \right. \\ & \quad \left. \left. \left. - \frac{\tau}{2 \cosh^2(\tau mh)} h \sum_{k=-N}^N f(\phi(kh))\phi'(kh) \right) \right\} S(k, h, \phi^{-1}(x)) \right] \right| \\ & \leq K\sqrt{N} \exp(-(\pi\alpha'_g c'_g N)^{1/2}), \end{aligned} \tag{4.28}$$

with

$$\begin{aligned}\alpha'_g &= \min(\alpha_g, 2\tau), \\ c'_g &= \min\left(c_g, \frac{\pi - 2\tau\varepsilon_c}{2\tau}\right), \\ h &= \sqrt{\frac{\pi c'_g}{\alpha'_g N}},\end{aligned}\tag{4.29}$$

and ε_c is any number such that $c'_g > 0$.

From (4.29) one will observe that

$$\alpha'_g c'_g \leq \min(\alpha_g c_g, \pi - 2\tau\varepsilon_c),\tag{4.30}$$

$$\text{where } \tau = \frac{\alpha_g}{2},\tag{4.31}$$

because it reduces the estimated error and gives us what Tanaka *et al.* call the best SE formula .

From the above theorem, we can now deduce Stenger's formula, which Tanaka *et al.* call the SE formula,

$$\begin{aligned}\int_{-1}^x f(u) du &= \left[\frac{\exp[\tau\phi^{-1}(x)]h}{2 \cosh(\tau\phi^{-1}(x))} \sum_{k=-N}^N f(\phi(kh))\phi'(kh) \right. \\ &\quad + h \sum_{k=-N}^N \left\{ \sum_{m=-N}^N I(k-m) \left(f(\phi(mh))\phi'(mh) \right. \right. \\ &\quad \left. \left. - \frac{\tau h}{2 \cosh^2(\tau mh)} \sum_{k=-N}^N f(\phi(kh))\phi'(kh) \right) \right\} S(k, h, \phi^{-1}(x)) \Big],\end{aligned}\tag{4.32}$$

with the step size given by (4.29).

We shall be taking a close look at the function space $\mathbf{H}^\infty(D_c, \omega)$, as it will give us expressions for the error estimates of the sinc approximation and, most importantly, will help us in the derivation of the step size h for computing Tanaka *et al.*'s formula .

4.2 Function Spaces

We shall give the definition of the function space $\mathbf{H}^\infty(D_c, \omega)$ as presented by Sugihara ([30], [29]). $\mathbf{H}^\infty(D_c, \omega)$ represents the space of analytic functions in the strip region D_c about the real axis. $\mathbf{H}^\infty(D_c, \omega)$ spaces are characterized by the decay rate of their elements (functions), and parametrised by ω in the neighbourhood of infinity [30]. The space was used by Sugihara [30] in the context of optimal quadrature in establishing the "meta-optimality" of the double exponential quadrature formulas.

Definition 4.4. *Let $\omega(z)$ be a non-vanishing function defined on the region D_c . If $f : D_c \rightarrow \mathbb{C}$ is a function, the space $\mathbf{H}^\infty(D_c, \omega)$ can be defined as*

$$\mathbf{H}^\infty(D_c, \omega) = \{f : f(z) \text{ is analytic in } D_c, \text{ and } \|f\| < +\infty\}, \quad (4.33)$$

where the norm is

$$\|f\| = \sup_{z \in D_c} |f(z)/\omega(z)|. \quad (4.34)$$

With the above definition, we have, for $z \in D_c$,

$$|f(z)| \leq \|f\| |\omega(z)|, \quad (4.35)$$

which means that $f \in \mathbf{H}^\infty(D_c, \omega)$ decays like $\omega(z)$ as $z \rightarrow \infty$ in D_c . If $\omega(z)$ decays single exponentially, the function in $\mathbf{H}^\infty(D_c, \omega)$ will decay single exponentially, and if $\omega(z)$ decays double exponentially, the function in $\mathbf{H}^\infty(D_c, \omega)$ will decay double exponentially.

4.2.1 Error Estimates

Let $\mathcal{E}_{N,h}^{\text{sinc}}(\mathbf{H}^\infty(D_c, \omega))$ denote the error norm in $\mathbf{H}^\infty(D_c, \omega)$ for the sinc approximation formula given by

$$\mathcal{E}_{N,h}^{\text{sinc}}(\mathbf{H}^\infty(D_c, \omega)) = \sup_{\|f\| \leq 1} \left\{ \sup_{x \in \mathbb{R}} \left| f(x) - \sum_{k=-N}^N f(kh) S(k, h, x) \right| \right\}, \quad (4.36)$$

and let $\mathcal{E}_{N,h}^{\text{min}}(\mathbf{H}^\infty(D_c, \omega))$ be the minimum error norm in $\mathbf{H}^\infty(D_c, \omega)$ taken over the family of all N -point quadrature formulas [29]

$$\int_{-\infty}^{\infty} f(x) dx \approx \sum_{k=0}^r \sum_{l=0}^{w_k-1} \beta_{kl} f^{(l)}(\alpha_k), \quad (4.37)$$

where $\alpha_k \in D_c$, $\beta_{kl} \in \mathbb{C}$, $N = w_1 + w_2 + \dots + w_r$ and

$$\mathcal{E}_{N,h}^{\text{min}}(\mathbf{H}^\infty(D_c, \omega)) = \inf_{1 \leq r \leq N} \inf_{\substack{\{w_i\}_{i=1}^r \\ N}} \inf_{\alpha_{kl}} \left\{ \sup_{\|f\| \leq 1} \left\{ \sup_{x \in \mathbb{R}} \left| f(x) - \sum_{k=1}^r \sum_{l=0}^{w_k-1} \beta_{kl} f^{(l)}(\alpha_k) \right| \right\} \right\}. \quad (4.38)$$

If $\mathcal{B}(D_c)$ is as given in Definition 3.3, the following theorems give the optimality results of the sinc approximation in $\mathbf{H}^\infty(D_c, \omega)$. The first theorem applies to the case where $\omega(z)$ decays single exponentially, which means that the integrand decays single exponentially, while the second theorem applies when $\omega(z)$ decays double exponentially, in which case the integrand also decays double exponentially [29].

Theorem 4.3. *Suppose that $\omega(z)$ satisfies the following conditions*

1. $\omega(z) \in \mathcal{B}(D_c)$,
2. $\omega(z)$ is non-vanishing at any point in D_c , and
3. the decay rate of $\omega(z)$ on the real axis satisfies

$$\alpha_1 \exp(-(\tau|x|)^\mu) \leq |\omega(x)| \leq \alpha_2 \exp(-(\tau|x|)^\mu), \quad x \in \mathbb{R},$$

where $\alpha_1, \alpha_2, \beta$ are positive constants and $\mu \geq 1$.

Then

$$\mathcal{E}_{N,h}^{\text{sinc}}(\mathbf{H}^\infty(D_c, \omega)) \leq K_{c,\omega} N^{\frac{1}{\mu+1}} \exp\left(-\left(\frac{\pi c \tau N}{2}\right)^{\frac{\mu}{\mu+1}}\right), \quad (4.39)$$

where the step size h is chosen as

$$h = (\pi c)^{\frac{1}{\mu+1}} (\tau N)^{-\frac{\mu}{\mu+1}},$$

$K_{c,\omega}$ is a constant depending on c and ω .

Theorem 4.4. Suppose that $\omega(z)$ satisfies the following conditions:

1. $\omega(z) \in \mathcal{B}(D_c)$,
2. $\omega(z)$ is non-vanishing at any point in D_c , and
3. the decay rate of $\omega(z)$ on the real axis satisfies

$$\alpha_1 \exp(-\tau_1 \exp(\lambda|x|)) \leq |\omega(x)| \leq \alpha_2 \exp(-\tau_2 \exp(\lambda|x|)), \quad x \in \mathbb{R},$$

where $\alpha_1, \alpha_2, \tau_1, \tau_2$ are positive constants.

Then

$$\mathcal{E}_{N,h}^{\text{sinc}}(\mathbf{H}^\infty(D_c, \omega)) \leq K'_{c,\omega} \exp\left(-\frac{\pi c \lambda N}{2 \log(\pi c \lambda N / (2\tau_2))}\right), \quad (4.40)$$

where $K'_{c,\omega}$ depends on c and ω .

Sugihara [30] remarks that it is good to consider the case where $\omega(z)$ decays double exponentially. The following theorem will shed more light on this case.

Theorem 4.5. There exists no function $\omega(z)$ that satisfies the conditions (1), (2) in Theorems 4.3, 4.4 and the decay rate of $\omega(z)$ on the real axis is

$$\omega(x) = O(\exp(-\tau \exp(\lambda|x|))), \quad \text{as } |x| \rightarrow \infty,$$

where $\tau > 0$ and $\lambda > \frac{\pi}{2c}$.

To prove Theorems 4.3 and 4.4, we shall state and prove Lemma 4.6, which gives upper estimates for the error norm of the sinc approximation formula without specifying h . But first the following important result is needed.

Lemma 4.5. *If $\omega(z)$ satisfies condition 1 and 2 in Theorem 4.3, then, for any $h > 0$,*

$$\mathcal{E}_{N,h}^{\text{sinc}}(\mathbf{H}^\infty(D_c, \omega)) \leq \frac{\exp(-\pi c/h)N_1(\omega, D_c)}{\pi c(1 - \exp(-2\pi c/h))} + \sum_{|k|>N} |\omega(kh)|. \quad (4.41)$$

Proof: Using the inequality (4.35) and condition 1 from Theorem 4.3 on $\omega(z)$, $\omega(z) \in \mathcal{B}(D_c)$ means that any $f(z) \in \mathbf{H}^\infty(D_c, \omega)$ also belongs to $\mathcal{B}(D_c)$. Since we have established that $f(z) \in \mathcal{B}(D_c)$, using the error estimate of the sinc approximation formula gives

$$\begin{aligned} \sup_{x \in \mathbb{R}} \left| f(x) - \sum_{k=-N}^N f(kh)S(k, h, x) \right| &\leq \sup_{x \in \mathbb{R}} \left| f(x) - \sum_{k=-\infty}^{\infty} f(kh)S(k, h, x) \right| \\ &\leq \frac{\exp(-\pi c/h)N_1(f, D_c)}{\pi c(1 - \exp(-2\pi c/h))} + \sum_{|k|>N} |f(kh)|, \end{aligned}$$

but $|f(kh)| \leq \|f\| |\omega(kh)|$, $N_1(f, D_c) \leq \|f\| N_1(\omega, D_c)$ and, taking the supremum of norm one of both sides, we will have (4.41). ■

Lemma 4.6. *If $\omega(z)$ satisfies all the conditions in Theorem 4.3, then for any $h > 0$,*

$$\mathcal{E}_{N,h}^{\text{sinc}}(\mathbf{H}^\infty(D_c, \omega)) \leq \frac{\exp(-\pi c/h)N_1(\omega, D_c)}{\pi c(1 - \exp(-2\pi c/h))} + \frac{2\alpha_2 \exp(-(\tau h N)^\mu)}{\mu(\tau h)^\mu N^{\mu-1}}, \quad (4.42)$$

and

$$\mathcal{E}_{N,h}^{\text{sinc}}(\mathbf{H}^\infty(D_c, \omega)) \leq \frac{\exp(-\pi c/h)N_1(\omega, D_c)}{\pi c(1 - \exp(-2\pi c/h))} + \frac{2\alpha_2 \exp(-\tau_2 \exp(\lambda h N))}{\tau_2 \lambda h \exp(\lambda h N)}. \quad (4.43)$$

Proof: We shall use condition 3 of Theorem 4.3 on $\omega(z)$ to give an estimate for the second term on the right-hand side of equation (4.41).

1. Needed in Theorem 4.3

$$\begin{aligned}
\sum_{|k|>N} |\omega(kh)| &\leq 2\alpha_2 \sum_{k=N+1}^{\infty} \exp(-(\tau kh)^\mu) \\
&\leq 2\alpha_2 \int_N^{\infty} \exp(-(\tau kh)^\mu) dx \\
&\leq \frac{2\alpha_2}{\mu(\tau h N)^\mu} \int_N^{\infty} \mu(\tau h)^\mu x^{\mu-1} \exp(-(\tau hx)^\mu) dx \\
&= \frac{2\alpha_2 \exp(-(\tau h N)^\mu)}{\mu(\tau h)^\mu N^{\mu-1}}.
\end{aligned}$$

Substituting this back into (4.41) we obtain (4.42).

2. Needed in Theorem 4.4

$$\begin{aligned}
\sum_{|k|>N} |\omega(kh)| &\leq 2\alpha_2 \sum_{k=N+1}^{\infty} \exp(-\tau_2 \exp(\lambda kh)) \\
&\leq \int_N^{\infty} \exp(-\tau_2 \exp(\lambda hx)) dx. \\
&= \frac{2\alpha_2 \exp(-\tau_2 \exp(\lambda h N))}{\tau_2 \lambda h \exp(\lambda h N)} \\
&\leq \frac{2\alpha_2}{\tau_2 \lambda h \exp(\lambda h N)} \int_N^{\infty} \tau_2 \lambda h \exp(\lambda hx) \exp(-\tau_2 \exp(\lambda hx)) dx \\
&= \frac{2\alpha_2 \exp(-\tau_2 \exp(\lambda h N))}{\tau_2 \lambda h \exp(\lambda h N)}.
\end{aligned}$$

A similar substitution of the last expression above into (4.41) yields (4.43). ■

Next, we shall attempt to obtain an expression for the step size h for a given N as obtained from [30] and use it to obtain the upper estimate for $\mathcal{E}_{N,h}^{\text{sinc}}$ given in Lemma 4.6.

1. Needed in Theorem 4.3

To find h , we equate the magnitude [29] of the first and second terms on the right-hand side of equation (4.42) to obtain

$$\exp(-\pi c/h) = \exp(-(\tau h N)^\mu). \quad (4.44)$$

Taking the logarithm to base e of both sides, $\frac{\pi c}{h} = (\tau h N)^\mu$, $\pi c = h^{\mu+1} \tau^\mu N^\mu$, and hence

$$h = (\pi c)^{\frac{1}{\mu+1}} (\tau N)^{-\frac{\mu}{\mu+1}}. \quad (4.45)$$

Substituting this into the first and second terms of (4.42), we have

$$\begin{aligned} \frac{\exp(-\pi c/h) N_1(\omega, D_c)}{\pi c(1 - \exp(-2\pi c/h))} &\leq K_1 \exp(-(\pi c \tau N)^{\frac{\mu}{\mu+1}}) \\ &\leq K'_1 \exp\left(-\left(\frac{\pi c \tau N}{2}\right)^{\frac{\mu}{\mu+1}}\right). \end{aligned}$$

Similarly,

$$\begin{aligned} \frac{2\alpha_2 \exp(-(\tau h N)^\mu)}{\mu(\tau h)^\mu N^{\mu-1}} &\leq K_2 N^{\frac{\mu}{\mu+1}} \exp(-(\pi c \tau N)^{\frac{\mu}{\mu+1}}) \\ &\leq K'_2 N^{\frac{\mu}{\mu+1}} \exp\left(-\left(\frac{\pi c \tau N}{2}\right)^{\frac{\mu}{\mu+1}}\right). \end{aligned}$$

Adding the two terms above gives us the $\mathcal{E}_{N,h}^{\text{sinc}}(\mathbf{H}^\infty(D_c, \omega))$ in Theorem 4.3.

2. Needed in Theorem 4.4

The same argument follows for obtaining

$$\exp(-\pi c/h) = \exp(-\tau_2 \exp(\lambda h N))$$

from (4.43). Taking the logarithm to base e of both sides we have $\log(\pi c \lambda N / \tau_2) =$

$\log h + \gamma hN$, hence the only h that solves the equation is

$$h = \frac{\log(\pi c \lambda N / \tau_2)}{\lambda N} + O\left(\frac{\log \log(\pi c \lambda N / \tau_2)}{\lambda N}\right), \quad N \rightarrow \infty.$$

We follow Sugihara [30] in choosing

$$h = \frac{\log(\pi c \lambda N / \tau_2)}{\lambda N}, \quad (4.46)$$

which is the expression for the step size of Tanaka *et al.*'s quadrature formula that we wanted to derive.

Substituting this into the right-hand side of (4.43) we have

$$\begin{aligned} \frac{\exp(-\pi c/h) N_1(\omega, D_c)}{\pi c(1 - \exp(-2\pi c/h))} &\leq K_3 \exp\left(-\frac{\pi c \lambda N}{\log(\pi c \lambda N / \tau_2)}\right) \\ &\leq K'_3 \exp\left(-\frac{\pi c \lambda N}{2 \log(\pi c \lambda N / \tau_2)}\right) \end{aligned}$$

and

$$\begin{aligned} \frac{2\alpha_2 \exp(-\tau_2 \exp(\lambda h N))}{\tau_2 \lambda h \exp(\lambda h N)} &= \frac{2\alpha_2 \exp(-\pi c \lambda N)}{\pi c \lambda \log(\pi c \lambda N / \tau_2)} \\ &\leq K_4 \frac{\exp(-\pi c N / 2)}{\log N}. \end{aligned}$$

Adding these together we have (4.40). Hence we have completed the proof of the upper estimates for the error norm of the sinc approximation formula and have also found an expression for the step size for Tanaka *et al.*'s quadrature formula. Next, we strive to achieve our second goal in this chapter.

4.3 Derivation of Tanaka *et al.*'s Formula

Definition 4.5. Let c be a positive number, \mathcal{D}_c a strip region in \mathbb{C} as in Definition 3.3, then the function space $\mathcal{B}(\mathcal{D}_c)$ is defined as

$$\mathcal{B}(\mathcal{D}_c) = \{f : f \text{ is analytic in } \mathcal{D}_c, N_1(f, \mathcal{D}_c) < \infty\} \quad (4.47)$$

where

$$N_1(f, \mathcal{D}_c) = \lim_{\varepsilon \rightarrow 0} \int_{\partial \mathcal{D}_c(\varepsilon)} |f(z)| |dz|, \quad (4.48)$$

$$\mathcal{D}_c(\varepsilon) = \{z \in \mathbb{C} : |x| < \frac{1}{\varepsilon}, |y| < c(1 - \varepsilon)\}. \quad (4.49)$$

Definition 4.6. Let b be a real number such that $b \in (0, \frac{\pi}{2})$ and let the fan-shaped domain \mathcal{F}_b be defined as

$$\mathcal{F}_b = \left\{ z \in \mathbb{C} : \frac{(\pi - 2b)}{2} < \arg z < \frac{\pi}{2} \right\}.$$

We need the following two theorems- the first one by Phragmén-Lindelöf and the second by Montel given in [15] but stated as propositions in [32], to prove Lemmas 4.9 and 4.10.

Proposition 4.1. Let f be analytic in \mathcal{F}_b and continuous in $\bar{\mathcal{D}}_b$. Then, if

$$|f(z)| \leq S, \quad \forall z \in \bar{\mathcal{F}}_b, \quad (4.50)$$

there exists $a < 0$ such that

$$f(re^{i\psi_b}) = O(e^{ar}), \quad r \rightarrow \infty, \quad (4.51)$$

where $\psi_b = \frac{\pi-2b}{2}$. Then there exists $S' > 0$, such that, for all $z \in \mathcal{F}_b$,

$$|f(z)| \leq S' \exp\left(\frac{a|z| \cos(\arg z)}{\cos \psi_b}\right). \quad (4.52)$$

Proposition 4.2. *Let f be analytic and bounded in $\{z \in \mathbb{C} : x > b, y_1 \leq y \leq y_2\}$. If $f(z) \rightarrow a$ as $x \rightarrow \infty, y = y_3$, then for a fixed y_3 such that $y_1 < y_3 < y_2$, $f(z)$ converges uniformly to a as $x \rightarrow \infty$ with respect to y such that $y_1 < y < y_2$.*

We restate Lemma 4.3 in this fashion.

Lemma 4.7. *Let $f \in \mathcal{B}(\mathcal{D}_c)$, then*

$$|\mathcal{I}(f, x) - \mathcal{I}(C(h, f, x), x)| \leq \frac{hN_1(f, \mathcal{D}_c)}{4c \sinh \frac{\pi c}{h}}. \quad (4.53)$$

The following fundamental result then holds from [32].

Theorem 4.6. *Assume that f satisfies the following:*

$$f \in \mathcal{B}(\mathcal{D}_c); \quad (4.54)$$

$$|f(x)| \leq \alpha \exp(-\tau \exp(\lambda|x|)), \quad \forall x \in \mathbb{R}, \quad (4.55)$$

for some positive numbers α, τ, λ and c . Then, there exists a positive number K independent of N , such that

$$\sup_{x \in \mathbb{R}} |f(x) - C(N, f, h, x)| \leq K \exp\left[\frac{-\pi c \lambda N}{\log(\pi c \lambda N / \tau)}\right], \quad (4.56)$$

where

$$h = \frac{\log(\pi c \lambda N / \tau)}{\lambda N}. \quad (4.57)$$

The above result can be applied to obtain the result in the next theorem.

Theorem 4.7. *If f satisfies (4.54) and (4.55),*

$$\mathcal{I}f \in \mathcal{B}(\mathcal{D}_c), \quad (4.58)$$

$$|\mathcal{I}(f, x)| \leq \alpha \exp(-\tau \exp(\lambda|x|)), \quad \forall x \in \mathbb{R}, \quad (4.59)$$

for some positive numbers α , τ , λ and c , then there exists a number K independent of N , such that

$$\sup_{x \in \mathbb{R}} |\mathcal{I}(f, x) - C(N, h, \mathcal{I}(C(N, f, h, x), x), x)| \leq K \exp \left[\frac{-\pi c \lambda N}{\log(\pi c \lambda N / \tau)} \right], \quad (4.60)$$

where h is as defined in (4.57).

The assumptions about Theorems 4.6 and 4.7 were stated in terms of f and $\mathcal{I}f$, but it is better to state the assumptions in terms of the integrand f . We give the general case, which does not involve the condition $\lim_{x \rightarrow \infty} \mathcal{I}(f, x) = 0$, in Theorem 4.9, but the theorem below, which was stated with a proof in [32] includes the condition $\lim_{x \rightarrow \infty} \mathcal{I}(f, x) = 0$.

Theorem 4.8. *If f satisfies (4.54), (4.55) and*

$$\int_{-\infty}^{\infty} f(u) \, du = 0, \quad (4.61)$$

then for any ε , $\varepsilon \in (0, c)$, there exists a positive number K_ε , independent of N such that

$$\sup_{x \in \mathbb{R}} |\mathcal{I}(f, x) - C(N, h, \mathcal{I}(C(N, f, h, x), x), x)| \leq K_\varepsilon \exp \left[\frac{-\pi(c - \varepsilon)\lambda N}{\log(\pi(c - \varepsilon)\lambda N / \tau)} \right], \quad (4.62)$$

with h given by

$$h = \frac{\log(\pi(c - \varepsilon)\lambda N / \tau)}{\lambda N}. \quad (4.63)$$

Proof: Let $c'' = c - \varepsilon$ and

$$\begin{aligned} c_1(x) &= \mathcal{I}(f, x) - C(N, h, \mathcal{I}(f, x), x) \\ c_2(x) &= C(N, h, \mathcal{I}(f, x), x) - C(N, h, \mathcal{I}(C(f, h, x), x), x) \\ c_3(x) &= C(N, h, \mathcal{I}(C(f, h, x), x), x) - C(N, h, \mathcal{I}(C(N, f, h, x), x), x), \end{aligned} \quad (4.64)$$

then

$$\begin{aligned} &|\mathcal{I}(f, x) - C(N, h, \mathcal{I}(C(N, h, f, x), x), x)| \leq \\ &|\mathcal{I}(f, x) - C(N, h, \mathcal{I}(f, x), x)| + |C(N, h, \mathcal{I}(f, x), x) - C(N, h, \mathcal{I}(C(f, h, x), x), x)| \\ &+ |C(N, h, \mathcal{I}(C(f, h, x), x), x) - C(N, h, \mathcal{I}(C(N, f, h, x), x), x)|. \end{aligned} \quad (4.65)$$

For $c_1(x)$, we shall use Lemma 4.10 and Theorem 4.6 with (4.56):

$$|c_1(x)| \leq K_1 \exp \left[\frac{-\pi c'' \lambda N}{\log(\pi c'' \lambda N / \tau)} \right]. \quad (4.66)$$

Applying Lemma 4.7 to

$$\begin{aligned} |\mathcal{I}(f, x) - \mathcal{I}(C(h, f, x), x)| &\leq \frac{h N_1(f, \mathcal{D}_c)}{4c \sinh \frac{\pi c}{h}} \\ &\leq K_2 h e^{-\frac{\pi c}{h}}, \end{aligned} \quad (4.67)$$

K_2 is independent of h and, from Lemma 4.4 and especially (4.19),

$$\begin{aligned} |c_2(x)| &= |C(N, h, \mathcal{I}(f, x), x) - C(N, h, \mathcal{I}(C(f, h, x), x), x)| \\ &\leq \|C(N, h)\|_\infty \sup_{x \in \mathbb{R}} |\mathcal{I}(f, x) - \mathcal{I}(C(f, h, x), x)| \\ &\leq \frac{2(3 + \log N)}{\pi} K_2 h e^{-\frac{\pi c}{h}} \\ &= K_2 \frac{2(3 + \log N)}{\pi} \frac{\log(\pi c'' \lambda N / \tau)}{\lambda N} \exp \left[\frac{-\pi c \lambda N}{\log(\pi c'' \lambda N / \tau)} \right] \\ &\leq K_3 \frac{(\log N)^2}{N} \exp \left[\frac{-\pi c \lambda N}{\log(\pi c'' \lambda N / \tau)} \right]. \end{aligned} \quad (4.68)$$

The constant K_3 is independent of N . Moreover, using (3.33) of Lemma 3.1

$$\begin{aligned}
|\mathcal{I}(C(f, h, x), x) - \mathcal{I}(C(N, f, h, x), x)| &= \left| \int_{-\infty}^x \sum_{|k|>N} f(kh) S(k, h, u) \, du \right| \\
&= \left| \sum_{|k|>N} f(kh) J(k, h, x) \right| \\
&= \sup_{x \in \mathbb{R}} |J(k, h, x)| \sum_{|k|>N} |f(kh)| \\
&\leq 1.1h \sum_{|k|>N} \alpha \exp(-\tau \exp(\lambda |kh|)) \\
&= 2.2\alpha h \sum_{k=N+1}^{\infty} \exp(-\tau \exp(\lambda kh)) \\
&\leq 2.2\alpha h \int_N^{\infty} \exp(-\tau \exp(\lambda hu)) \, du \\
&\leq \frac{2.2\alpha h}{\tau \lambda h \exp(\lambda hN)} \int_N^{\infty} \tau \lambda h \exp(\lambda hu) \\
&\quad \times \exp(-\tau \exp(\lambda hu)) \, du \\
&= \frac{2.2\alpha \exp(-\tau \exp(\lambda hN))}{\tau \lambda \exp(\lambda hN)} \\
&= \frac{2.2\alpha \exp(-\pi c'' \lambda N)}{\tau \lambda \exp(\log(\pi c'' \lambda N / \tau))} \\
&= \frac{2.2\alpha \exp(-\pi c'' \lambda N)}{\pi c'' \lambda^2 N}. \tag{4.69}
\end{aligned}$$

Similarly,

$$\begin{aligned}
|c_3(x)| &= |C(N, h, \mathcal{I}(C, f, h, x), x) - C(N, h, \mathcal{I}(C(N, f, h, x), x), x)| \\
&\leq \|C(N, h)\|_{\infty} \sup_{x \in \mathbb{R}} |\mathcal{I}(C(f, h, x), x) - \mathcal{I}(C(N, f, h, x), x)| \\
&\leq K_4 \frac{\log N}{N} \exp(-\pi c'' \lambda N). \tag{4.70}
\end{aligned}$$

Recall that $c'' = c - \varepsilon$. Then adding (4.66), (4.68) and (4.70) yields

$$\begin{aligned}
\sup_{x \in \mathbb{R}} |\mathcal{I}(f, x) - C(N, h, \mathcal{I}(C(N, f, h, x), x), x)| &\leq K_1 \exp \left[\frac{-\pi c'' \lambda N}{\log(\pi c'' \lambda N / \tau)} \right] \\
&+ \leq K_3 \frac{(\log N)^2}{N} \exp \left[\frac{-\pi c \lambda N}{\log(\pi c'' \lambda N / \tau)} \right] \\
&+ K_4 \frac{\log N}{N} \exp(-\pi c'' \lambda N) \\
&\leq K_\varepsilon \exp \left[\frac{-\pi(c - \varepsilon) \lambda N}{\log(\pi(c - \varepsilon) \lambda N / \tau)} \right].
\end{aligned}$$

■

Let ε be an arbitrary positive number and set $c' = \frac{2c - \varepsilon}{2}$.

Lemma 4.8. *If the conditions (4.54) and (4.55) hold, then there exists a positive number $S(c')$ dependent on c' , such that*

$$|f(z)| \leq S(c'), \quad \forall z \in \bar{\mathcal{D}}_c. \quad (4.71)$$

Proof: For a fixed $z \in \bar{\mathcal{D}}_{c'}$, the following inequality was obtained by Cauchy's integral formula [32]:

$$|f(z)| \leq \frac{2}{\pi(c(1 - \nu) - |y|)} \int_{\partial \mathcal{D}_c(\nu)} |f(\xi)| |d\xi|, \quad (4.72)$$

with $\mathcal{D}_c(\nu)$ as defined in (4.49) and ν being a small positive number. Then

$$\begin{aligned}
|f(z)| &\leq \lim_{\nu \rightarrow 0} \frac{2}{\pi(c(1 - \nu) - |y|)} \int_{\partial \mathcal{D}_c(\nu)} |f(\xi)| |d\xi| \\
&= \frac{2N_1(f, \mathcal{D}_c)}{\pi(c - |y|)} \\
&\leq \frac{4N_1(f, \mathcal{D}_c)}{\pi(c - c')},
\end{aligned}$$

which establishes (4.71). ■

The next lemma is an immediate consequence of the above result.

Lemma 4.9. *If f is analytic in $\bar{\mathcal{D}}_{c'}$, if (4.55) and (4.71) hold, and if we set*

$$B(\lambda, c', y) = [\cos(\lambda|y|) - \cot(\lambda c') \sin(\lambda|y|)]\tau, \quad (4.73)$$

then

$$|f(z)| \leq S' \exp(-B(\lambda, c', y) \exp(\lambda|x|)), \quad (4.74)$$

for all y such that $-c' \leq y \leq c'$.

Proof: We follow Tanaka *et al.* [32] in considering the case where (x, y) is in the first quadrant of $\bar{\mathcal{D}}_{c'}$.

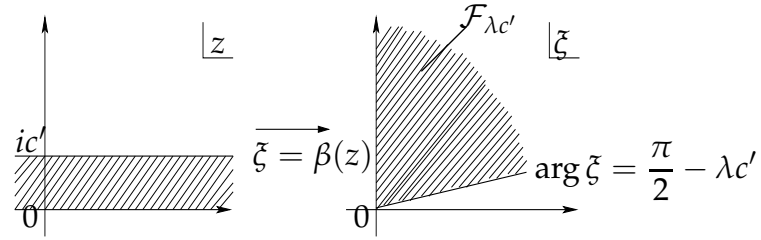

Figure 4.1: Conformal transformation diagram

We begin by defining the conformal map β as

$$\xi = \beta(z) = \exp(\lambda z + i(\pi - 2\lambda c')/2)$$

and set $g(\xi) = f(\beta^{-1}(\xi))$. Let $z = x + iy$ and $\mathcal{F}_{\lambda c'}$ be as shown in Figure 4.1. Proposition 4.1 can then be applied on g .

It is easily seen that g is analytic in $\mathcal{F}_{\lambda c'}$ and continuous in the closure of $\mathcal{F}_{\lambda c'}$, except at the origin, i.e. $\bar{\mathcal{F}}_{\lambda c'} - \{0\}$. From (4.71) and using the fact that f is bounded in $\bar{\mathcal{D}}_{c'}$, $\lim_{x \rightarrow \pm\infty} f(x) = 0$ and Proposition 4.2 guarantees the continuity of g at the origin. Hence, we have shown that g is analytic in $\mathcal{F}_{\lambda c'}$ and continuous in $\bar{\mathcal{F}}_{\lambda c'}$.

Moreover, from (4.71) and the continuity of g in $\bar{\mathcal{F}}_{\lambda c'}$, we have

$$|g(\tilde{\zeta})| = |f(z)| \leq S(c'), \quad \forall \tilde{\zeta} \in \bar{\mathcal{F}}_{\lambda c'}. \quad (4.75)$$

From

$$1 \leq |\tilde{\zeta}|, \Rightarrow |\tilde{\zeta}| = e^{\lambda x} = e^{\lambda|x|}$$

and (4.55) with $\arg \tilde{\zeta} = \frac{\pi - 2\lambda c'}{2}$,

$$g(\tilde{\zeta}) = O(\exp(-\tau \exp(\lambda|x|))) = O(\exp(-\tau|\tilde{\zeta}|)), \quad |\tilde{\zeta}| \rightarrow \infty. \quad (4.76)$$

Thus, g has satisfied all the assumptions of Proposition 4.1 and

$$|g(\tilde{\zeta})| \leq S' \exp \left[\frac{-\cos(\arg \tilde{\zeta})}{\cos(\frac{\pi-2\lambda c'}{2})} \tau |\tilde{\zeta}| \right]. \quad (4.77)$$

By transforming the above result to the z plane, with a in (4.52) replaced by $-\tau$, as in the above,

$$\begin{aligned} |f(z)| &\leq S' \exp \left[\frac{-\cos(\frac{\pi-2\lambda(c'-y)}{2})}{\cos(\frac{\pi-2\lambda c'}{2})} \tau \exp(\lambda|x|) \right] \\ &= S' \exp \left(\frac{-\sin(\lambda(c'-y))}{\sin(\lambda c')} \tau \exp(\lambda|x|) \right) \\ &= S' \exp(-B(\lambda, c', y) \exp(\lambda|x|)), \quad x, y \geq 0, \end{aligned} \quad (4.78)$$

for all z in $\bar{\mathcal{D}}_c \cap z$. ■

This motivates the following result for functions that decay double exponentially.

Lemma 4.10. *If f is analytic in $\bar{\mathcal{D}}_c$ under the conditions (4.61) and (4.74), there exists*

$\alpha' > 0$ such that

$$\mathcal{I}f \in \mathcal{B}(\mathcal{D}_{c''}), \quad (4.79)$$

$$|\mathcal{I}(f, x)| \leq \alpha' \exp(-\tau \exp(\lambda|x|)). \quad (4.80)$$

Proof: The proof of this theorem has two steps. In the first step we shall consider three cases. To start with, we shall estimate the value of $\int_{-\infty}^z f(\xi) d\xi$ where $z = x + iy \in \mathcal{D}_{c''}$.

Case one: $x < 0$, $y \geq 0$, using (4.78)

$$\begin{aligned} \left| \int_{-\infty}^z f(\xi) d\xi \right| &= \left| \int_{-\infty}^x f(v) dv + \int_0^y f(x + iu) i du \right| \\ &\leq \int_{-\infty}^x |f(v)| dv + \int_0^y |f(x + iu)| du \\ &\leq S' \left[\int_{-\infty}^x \exp(-\tau \exp(-\lambda v)) dv \right. \\ &\quad \left. + \int_0^y \exp \left\{ \frac{-\exp(-\lambda x) \sin(\lambda(c' - u))\tau}{\sin \lambda c'} \right\} du \right]. \end{aligned} \quad (4.81)$$

Considering the two terms in (4.81) separately,

$$\begin{aligned} S_1(x) &= \int_{-\infty}^x \exp(-\tau \exp(-\lambda v)) dv \\ &\leq \int_{-\infty}^x \exp(-\lambda v) \exp(-\tau \exp(-\lambda v)) dv \\ &= \frac{1}{\tau \lambda} \int_{-\infty}^x \tau \lambda \exp(-\lambda v) \exp(-\tau \exp(-\lambda v)) dv \\ &= \frac{1}{\tau \lambda} \exp(-\tau \exp(-\lambda x)) \\ &= \frac{1}{\tau \lambda} \exp(-\tau \exp(\lambda|x|)). \end{aligned} \quad (4.82)$$

For the second term on the right-hand side of (4.81) we shall make use of $\lambda \leq \frac{\pi}{2c'}$, $c > c' > c'' \geq u \geq 0$ and $\sin(\lambda(c' - u)) \geq \frac{2\lambda(c' - u)}{\pi}$. Thus

$$\begin{aligned}
S_2(x) &= \int_0^y \exp \left\{ \frac{-\exp(-\lambda x) \sin(\lambda(c' - u))\tau}{\sin \lambda c'} \right\} du \\
&\leq \int_0^y \exp \left\{ \frac{-2\tau \exp(-\lambda x)(\lambda(c' - u))}{\pi \sin \lambda c'} \right\} du \\
&\leq \int_0^{\frac{2c' - \varepsilon}{2}} \exp \left\{ \frac{-2\tau \exp(-\lambda x)(\lambda(c' - u))}{\pi \sin \lambda c'} \right\} du \\
&= \frac{\pi \exp(\lambda x) \sin \lambda c'}{2\tau \lambda} \exp \left\{ \frac{-2\tau \exp(-\lambda x)(\lambda(c' - u))}{\pi \sin \lambda c'} \right\} \Big|_0^{\frac{2c' - \varepsilon}{2}} \\
&= \frac{\pi \exp(\lambda x) \sin \lambda c'}{2\tau \lambda} \left[\exp \left\{ \frac{-\tau \lambda \varepsilon \exp(\lambda|x|)}{\pi \sin \lambda c'} \right\} \right. \\
&\quad \left. - \exp \left\{ \frac{-2\tau \lambda c' \exp(\lambda|x|)}{\pi \sin \lambda c'} \right\} \right]. \tag{4.83}
\end{aligned}$$

Hence

$$|\mathcal{I}(f, x)| \leq S_1(x) + S_2(x). \tag{4.84}$$

Case two: When $x \geq 0, y \geq 0$

$$\begin{aligned}
\left| \int_{-\infty}^z f(\xi) d\xi \right| &= \left| \int_{-\infty}^x f(v) dv + \int_0^y f(x + iu)i du \right| \\
&= \left| -\int_x^{\infty} f(v) dv + \int_0^y f(x + iu)i du \right| \\
&\leq \int_x^{\infty} |f(v)| dv + \int_0^y |f(x + iu)| du \tag{4.85}
\end{aligned}$$

An application of (4.74) to the above will give us a similar bound as in (4.82) and (4.83).

Case three: When $y < 0$, the bounds for $\int_{-\infty}^z f(\xi) d\xi$ should be symmetric about the x -axis, hence we have the same bounds as in (4.82) and (4.83).

The second step follows from the result of step 1 in the case where $y = 0$, $\left| \int_{-\infty}^z f(\xi) d\xi \right| \leq \int_{-\infty}^x |f(v)| dv \leq O(\exp(-\tau \exp(\lambda|x|)))$, proving (4.80).

For us to compute $N_1(\mathcal{I}(f, \mathcal{D}_{c''}))$ in proving (4.79), we shall define the bound-

ary of integration as

$$\left\{ z \in \mathbb{C} : -\left(\frac{1}{\nu}\right) \leq x \leq \left(\frac{1}{\nu}\right), -c''(1-\nu) \leq y \leq c''(1-\nu) \right\}.$$

Integrating round the contour, yields

$$\begin{aligned} |\mathcal{I}(f, z)| &\leq \overbrace{\int_{-c''(1-\nu)}^{c''(1-\nu)} |\mathcal{I}(f, -(1/\nu) + iy)| dy}^{I_a(\nu)} + \overbrace{\int_{-c''(1-\nu)}^{c''(1-\nu)} |\mathcal{I}(f, (1/\nu) + iy)| dy}^{I_b(\nu)} \\ &+ \overbrace{\int_{-(1/\nu)}^{(1/\nu)} |\mathcal{I}(f, x - ic''(1-\nu))| dx}^{I_c(\nu)} + \overbrace{\int_{-(1/\nu)}^{(1/\nu)} |\mathcal{I}(f, x + ic''(1-\nu))| dx}^{I_d(\nu)}. \end{aligned} \quad (4.86)$$

Note that (4.84) holds for all $z \in \mathcal{D}_{c''}$. Hence

$$\begin{aligned} |\mathcal{I}(f, z)| &\leq I_a(\nu) + I_b(\nu) + I_c(\nu) + I_d(\nu) \\ &\leq 4c''(S_1(1/\nu) + S_2(1/\nu)) + \int_{-(1/\nu)}^{(1/\nu)} (S_1(x) + S_2(x)) dx. \end{aligned} \quad (4.87)$$

But $S_1(x) = O(\exp(-\tau \exp(\lambda|x|)))$, $S_2(x) = o(\exp(-\lambda|x|))$, and this implies that $\mathcal{I}(f, z)$ is bounded as $\nu \rightarrow 0$. Therefore, $\mathcal{I}f \in B(\mathcal{D}_{c''})$, proving (4.79). ■

On the basis of the discussion preceding Theorem 4.7, we present the general case, in which (4.61) is not assumed. We consider

$$v(z) = f(z) - \omega \int_{-\infty}^{\infty} f(u) du, \quad (4.88)$$

where ω is normalised such that $\int_{-\infty}^{\infty} \omega(u) du = 1$. Then

$$\int_{-\infty}^{\infty} v(u) du = 0. \quad (4.89)$$

In order to apply Theorem 4.7 to v , Tanaka *et al.* [32] suggest that we choose ω in such a way that (4.54) and (4.55) are satisfied for some α , τ , λ and c . They chose

$$\omega(z) = \frac{d}{dz} \left[\frac{\tanh(P \sinh(Qz)) + 1}{2} \right] = \frac{PQ \cosh(Qz)}{2 \cosh^2(P \sinh(Qz))}, \quad (4.90)$$

parametrized by P and Q . They also introduced the notation

$$s(z) = \omega(z) \int_{-\infty}^{\infty} f(u) du. \quad (4.91)$$

The decay rates of ω and v , and the function space that contains them are stated in the Proposition 4.4 and Lemma 4.12. The results are useful for finding the parameters of Tanaka *et al.*'s formula (4.112).

Upon applying Theorem 4.6 to v , and from the assumptions (4.54) and (4.55) on f , we obtain the following fundamental result:

Theorem 4.9. *If f satisfies*

$$f \in \mathcal{B}(\mathcal{D}_{c_f}), \quad (4.92)$$

$$|f(x)| \leq \alpha_f \exp(-\tau_f \exp(\lambda_f |x|)), \quad \forall x \in \mathbb{R}, \quad (4.93)$$

for some positive numbers α_f , τ_f , λ_f and c_f , then for any $\varepsilon \in (0, c_v)$ there exists a positive number K_ε , independent of N , such that

$$\begin{aligned} & \sup_{x \in \mathbb{R}} \left| \int_{-\infty}^x f(u) du - \left[\frac{\tanh(P \sinh(Qz)) + 1}{2} \int_{-\infty}^{\infty} f(u) du \right. \right. \\ & \quad \left. \left. + h \sum_{k=-N}^N \left\{ \sum_{m=-N}^N \sigma_{k-m} \left(f(kh) - \omega(mh) \int_{-\infty}^{\infty} f(u) du \right) \right\} S(k, h, x) \right] \right| \\ & = \sup_{x \in \mathbb{R}} |\mathcal{I}(f, x) - \{\mathcal{I}(s, x) + C(N, h, \mathcal{I}(C(N, h, v, x), x), x)\}| \\ & \leq K_\varepsilon \exp \left[\frac{-\pi(c_v - \varepsilon)\lambda_v N}{\log(\pi(c_v - \varepsilon)\lambda_v N / \tau_v)} \right], \end{aligned} \quad (4.94)$$

where

$$h = \frac{\log(\pi(c_v - \varepsilon)\lambda_v N / \tau_v)}{\lambda_v N}, \quad (4.95)$$

τ_v , λ_v and c_v are as defined in (4.118), (4.119) and (4.120) respectively.

In actual computations, $\int_{-\infty}^{\infty} f(u) du$ should be replaced by $h \sum_{k=-N}^N f(kh)$. We need the following proposition and lemma in order to understand the proof of Theorem 4.10.

Proposition 4.3. *If f satisfies (4.92) and (4.93) for some α_f , τ_f and c_f , then we have, for a constant K independent of N ,*

$$\left| \int_{-\infty}^{\infty} f(u) du - h \sum_{k=-N}^N f(kh) \right| \leq K \exp \left[\frac{-2\pi c_f \lambda_v N}{\log(\pi(c_v - \varepsilon)\lambda_v N / \tau_v)} \right], \quad (4.96)$$

where h is as defined in (4.95).

Lemma 4.11. *Let h be as defined in (4.95), then*

$$\mathcal{I}(\omega, x) - C(N, h, \mathcal{I}(C(N, \omega, h, x), x), x) = O(\log N), \quad (N \rightarrow \infty). \quad (4.97)$$

Proof:

$$\begin{aligned} & |\mathcal{I}(\omega, x) - C(N, h, \mathcal{I}(C(N, h, \omega, x), x), x)| \\ & \leq |\mathcal{I}(\omega, x) - C(N, h, \mathcal{I}(\omega, x), x)| + |C(N, h, \mathcal{I}(\omega, x), x) - C(N, h, \mathcal{I}(C(h, \omega, x), x), x)| \\ & + |C(N, h, \mathcal{I}(C(h, \omega, x), x), x) - C(N, h, \mathcal{I}(C(N, h, \omega, x), x), x)|. \end{aligned} \quad (4.98)$$

The second and third terms on the right-hand side of (4.98) are bounded, using a similar technique to those used in (4.68) and (4.70). Also, from the fact that $\sup_{x \in \mathbb{R}} |\mathcal{I}(\omega, x)|$ is finite and, using similar arguments to those in (4.70), it will be discovered that the first term on the right hand side of (4.98) is bounded by $K \log N$ for some K . ■

The following fundamental result then holds.

Theorem 4.10. *Assuming that all the assumptions in Theorem 4.9 hold, then the following estimate holds for some K'_ε :*

$$\begin{aligned} & \sup_{x \in \mathbb{R}} \left| \int_{-\infty}^x f(u) \, du - \left[\frac{\tanh(P \sinh(Qx)) + 1}{2} h \sum_{k=-N}^N f(kh) \right. \right. \\ & \quad \left. \left. + h \sum_{k=-N}^N \left\{ \sum_{m=-N}^N \sigma_{k-m} \left(f(kh) - \frac{PQ \cosh(Qmh)}{2 \cosh^2(P \sinh(Qmh))} \times \right. \right. \right. \right. \\ & \quad \left. \left. \left. h \sum_{k=-N}^N f(kh) \right) \right\} S(k, h, x) \right] \right| \\ & \leq K'_\varepsilon \exp \left[\frac{-\pi(c_v - \varepsilon)\lambda_v N}{\log(\pi(c_v - \varepsilon)\lambda_v N / \tau_v)} \right]. \end{aligned} \quad (4.99)$$

Proof: Let $\bar{s}_N = \omega h \sum_{k=-N}^N f(kh)$ and $\bar{v}_N = f - \bar{s}_N$, then the quadrature formula (4.99) can be written as

$$\mathcal{I}(\bar{s}_N, x) + C(N, h, \mathcal{I}(C(N, h, \bar{v}_N, x), x), x), \quad (4.100)$$

and the difference between (4.99) and (4.94) can be expressed as

$$\mathcal{I}(\bar{s}_N - s, x) + C(N, h, \mathcal{I}(C(N, h, \bar{v}_N - v, x), x), x). \quad (4.101)$$

Thus, in order to prove (4.99), it suffices to show that

$$\begin{aligned} & \mathcal{I}(\bar{s}_N - s, x) + C(N, h, \mathcal{I}(C(N, h, \bar{v}_N - v, x), x), x) \\ & = o \left(\exp \left[\frac{-\pi(c_v - \varepsilon)\lambda_v N}{\log(\pi(c_v - \varepsilon)\lambda_v N / \tau_v)} \right] \right), \end{aligned}$$

which can be derived from Proposition 4.3 and Lemma 4.11:

$$\begin{aligned}
& |\mathcal{I}(\bar{s}_N - s, x) + C(N, h, \mathcal{I}(C(N, h, \bar{v}_N - v, x), x), x)| \\
&= |\mathcal{I}(\omega, x) + C(N, h, \mathcal{I}(C(N, h, \omega, x), x), x)| \left| \int_{-\infty}^{\infty} f(u) \, du - h \sum_{k=-N}^N f(kh) \right| \\
&\leq K' \log N \exp \left[\frac{-2\pi c_f \lambda_v N}{\log(\pi(c_v - \varepsilon) \lambda_v N / \tau_v)} \right] \\
&= o \left(\exp \left[\frac{-\pi(c_v - \varepsilon) \lambda_v N}{\log(\pi(c_v - \varepsilon) \lambda_v N / \tau_v)} \right] \right).
\end{aligned}$$

■

4.4 Analysis of Tanaka *et al.*'s Formula

In this section, we shall be concerned with the analysis of the formula for numerical indefinite integration on the finite interval $[-1, 1]$, having considered the infinite interval in the previous section. We shall do this by transforming the interval in the last section from $(-\infty, \infty)$ to $(-1, 1)$, using DE transformation.

4.4.1 Double Exponential Transformation

In approximating $F(x) = \int_{-1}^x f(u) \, du$, $-1 < x < 1$, we shall make a double exponential transformation, $u = \phi_1(t)$ in line with Mori ([21], [31]), using

$$\phi_1(t) = \tanh \left[\frac{\pi}{2} \sinh t \right], \quad (4.102)$$

giving

$$\phi_1'(t) = \frac{\pi \cosh t}{2 \cosh^2 \left(\frac{\pi}{2} \sinh t \right)}, \quad (4.103)$$

which maps the entire real line $(-\infty, \infty)$ to $(-1, 1)$, i.e. $\phi_1(t)$ satisfies

$$\begin{cases} -1 = \phi_1(-\infty) = \tanh \left[\frac{\pi}{2} \sinh(-\infty) \right]; \\ 1 = \phi_1(\infty) = \tanh \left[\frac{\pi}{2} \sinh(\infty) \right]. \end{cases} \quad (4.104)$$

To find the inverse, let $u = \tanh \left[\frac{\pi}{2} \sinh t \right]$, $\frac{\pi}{2} \sinh t = \tanh^{-1} u$,
 $t = \sinh^{-1} \left(\frac{2}{\pi} \tanh^{-1} u \right)$. Alternatively, using $\tanh x = \frac{e^x - e^{-x}}{e^x + e^{-x}} = u$, $x = \tanh^{-1} u$, cross-multiplying and taking \log_e of both sides, we have $x = \frac{1}{2} \log \left(\frac{1+u}{1-u} \right)$,
 thus $\frac{\pi}{2} \sinh t = \frac{1}{2} \log \left(\frac{1+u}{1-u} \right)$ and

$$t = \phi_1^{-1}(u) = \sinh^{-1} \left[\frac{1}{\pi} \log \left(\frac{1+u}{1-u} \right) \right] = \sinh^{-1} \left[\frac{2}{\pi} \tanh^{-1} u \right]. \quad (4.105)$$

With the above analysis one can now define a double exponential transformation and decay.

Definition 4.7. A function f is said to decay double exponentially [22] if there exist positive constants α and K , such that

$$|f(x)| \leq K \exp(-\alpha \exp(|x|)) \text{ for all } x \in \mathbb{R}. \quad (4.106)$$

Alternatively, a function f is said to decay double exponentially with respect to the conformal map ϕ_1 , if there exist positive constants α and K , such that

$$|f(\phi_1(x))\phi_1'(x)| \leq K \exp(-\alpha \exp(|x|)) \text{ for all } x \in \mathbb{R}. \quad (4.107)$$

Thus, any ϕ_1 satisfying (4.107) is called a double exponential transformation [22].

Consequently, we have

$$\int_{-1}^x f(u) \, du = \int_{-\infty}^{\phi_1^{-1}(x)} f(\phi_1(t)) \phi_1'(t) \, dt.$$

With the expression above, (4.99) can now be re-written as (4.110) below. Paving way for the next theorem which gives an expression for the estimate of the error on the interval $(-1, 1)$.

Theorem 4.11. *Using the variable transformation $u = \phi_1(t)$, the transformed function $g(t) = f(\phi_1(t))\phi_1'(t)$ satisfies*

$$g \in \mathcal{B}(\mathcal{D}_{c_f}), \quad (4.108)$$

$$|g(x)| \leq \alpha_g \exp(-\tau_g \exp(\lambda_g |x|)), \quad (4.109)$$

for positive numbers $\alpha_g, \tau_g, \lambda_g$ and c_g . Then, for any $\varepsilon \in (0, c_\delta)$, there is a positive number K_ε'' , independent of N , such that

$$\begin{aligned} \sup_{-1 < x < 1} \left| \int_{-1}^x f(u) \, du - \left[\frac{\tanh(P \sinh(Q\phi_1^{-1}(x))) + 1}{2} h \sum_{k=-N}^N f(\phi_1(kh)) \phi_1'(kh) \right. \right. \\ \left. \left. + h \sum_{k=-N}^N \left\{ \sum_{m=-N}^N \sigma_{k-m} \left(f(\phi_1(mh)) \phi_1'(mh) \right. \right. \right. \right. \\ \left. \left. \left. - \frac{PQ \cosh(Qmh)}{2 \cosh^2(P \sinh(Qmh))} h f(\phi_1(mh)) \phi_1'(mh) \right) \right\} \right. \\ \left. \times \operatorname{sinc} \left(\frac{\phi_1^{-1}(x) - kh}{h} \right) \right] \Big| \\ \leq K_\varepsilon'' \exp \left[\frac{-\pi(c_\delta - \varepsilon) \lambda_\delta N}{\log(\pi(\lambda_\delta - \varepsilon) \lambda_\delta N / \tau_\delta)} \right], \quad (4.110) \end{aligned}$$

where \hat{v} and h are defined as

$$\hat{v} = g - s, \quad h = \frac{\log(\pi(\lambda_\delta - \varepsilon) \lambda_\delta N / \tau_\delta)}{\lambda_\delta N}, \quad (4.111)$$

and where $P, Q, \lambda_{\hat{v}}, \tau_{\hat{v}}$ and $c_{\hat{v}}$ are as defined in either (4.124) to (4.128) or (4.129) to (4.132), with f and v replaced by g and \hat{v} respectively.

Tanaka *et al.*'s formula can now be deduced from (4.110) above as:

$$\begin{aligned} \int_{-1}^x f(u) \, du &= \frac{\tanh(P \sinh(Q\phi_1^{-1}(x))) + 1}{2} h \sum_{k=-N}^N f(\phi_1(kh)) \phi_1'(kh) \\ &+ h \sum_{k=-N}^N \left\{ \sum_{m=-N}^N \sigma_{k-m} \left(f(\phi_1(mh)) \phi_1'(mh) \right. \right. \\ &\left. \left. - \frac{PQ \cosh(Qmh)}{2 \cosh^2(P \sinh(Qmh))} h f(\phi_1(mh)) \phi_1'(mh) \right) \right\} S(k, h, \phi_1^{-1}(x)). \end{aligned} \quad (4.112)$$

4.4.2 Determining the Parameters

Our choice of the parameters P and Q is without any restriction (we are free to choose them), but with the intention of minimising the error in (4.99) for a given integrand f . The determination of the set of parameters (P, Q) should be such that they give the maximum value of $\lambda_v c_v$, and choosing among the maximizers [32] (P, Q) that make τ_v as large as possible. Bear in mind that τ_v, λ_v and c_v are to be determined from P and Q using the results in Proposition 4.4 and Lemma 4.12.

The following propositions and the explanations that follow help one to determine the parameters.

Proposition 4.4. *Let $\tau_\omega, \lambda_\omega$ and c_ω be determined as*

$$\tau_\omega = \begin{cases} P - \varepsilon_\tau, \lambda_\omega = Q, c_\omega = \frac{\pi - 2Q\varepsilon_c}{2Q}, & P \in (0, \frac{\pi}{2}); \\ P - \varepsilon_\tau, \lambda_\omega = Q, c_\omega = \frac{\sin^{-1}(\frac{\pi}{2P}) - Q\varepsilon_c}{Q}, & P \geq \frac{\pi}{2}; \end{cases} \quad (4.113)$$

where ε_τ and ε_c are positive numbers such that $\tau_\omega > 0$ and $c_\omega > 0$. Then we have

$$\omega \in \mathcal{B}(\mathcal{D}_{c_\omega}), \quad (4.114)$$

$$|\omega(x)| \leq \alpha_\omega \exp(-\tau_\omega \exp(\lambda_\omega |x|)), \quad \forall x \in \mathbb{R}. \quad (4.115)$$

Lemma 4.12. Let τ_f , λ_f and c_f be constants such that

$$f \in \mathcal{B}(\mathcal{D}_{c_f}), \quad (4.116)$$

$$|f(x)| \leq \alpha_f \exp(-\tau_f \exp(\lambda_f |x|)), \quad \forall x \in \mathbb{R}. \quad (4.117)$$

If τ_ω , λ_ω and c_ω are constants as defined in (4.113), then for

$$\tau_v = \begin{cases} \tau_f, & \lambda_f < \lambda_\omega \\ \tau_\omega, & \lambda_f > \lambda_\omega \\ \min(\tau_f, \tau_\omega), & \lambda_f = \lambda_\omega \end{cases} \quad (4.118)$$

$$\lambda_v = \min(\lambda_f, \lambda_\omega) \quad (4.119)$$

$$c_v = \min(c_f, c_\omega) \quad (4.120)$$

we have

$$v \in \mathcal{B}(\mathcal{D}_{c_v}) \quad (4.121)$$

$$|v(x)| \leq \alpha_v \exp(-\tau_v \exp(\lambda_v |x|)), \quad \forall x \in \mathbb{R}. \quad (4.122)$$

Proposition 4.5. If f satisfies the conditions (4.92) and (4.93) and $f \neq 0$, then $\lambda_v c_v \leq \frac{\pi}{2}$.

To start with, we want to emphasise that (4.119) and (4.120) imply that

$$\lambda_v c_v \leq \lambda_f c_f, \quad (4.123)$$

where $\lambda_f c_f \leq \frac{\pi}{2}$. We shall divide the argument into two cases, depending on the value of $\lambda_f c_f$.

First Case: $\lambda_f c_f < \frac{\pi}{2}$

$$P = \frac{\pi}{2 \sin \lambda_f c_f} - \varepsilon_P, \quad (4.124)$$

$$Q = \lambda_f, \quad (4.125)$$

where ε_P , is any positive number such that $P > \frac{\pi}{2}$. Then

$$\lambda_v = \min\{\lambda_f, Q\} = \lambda_f, \quad (4.126)$$

$$\begin{aligned} c_v &= \min \left\{ c_f, \frac{\arcsin \frac{\pi}{2P} - 2\varepsilon_c Q}{Q} \right\} \\ &= \min \left\{ c_f, \frac{1}{\lambda_f} \arcsin \left[\frac{\pi \sin \lambda_f c_f}{\pi - 2\varepsilon_P \sin \lambda_f c_f} \right] - \varepsilon_c \right\} \\ &= \min \left\{ c_f, \frac{1}{\lambda_f} \arcsin \left[\frac{\sin \lambda_f c_f}{1 - (2\varepsilon_P/\pi) \sin \lambda_f c_f} \right] - \varepsilon_c \right\} \\ &= c_f. \end{aligned} \quad (4.127)$$

Because ε_P and ε_c are very small, $\lambda_v c_v$ in (4.123), attains the upper bound $\lambda_f c_f$, which is obtained when $\lambda_v = \lambda_f$ and $c_v = c_f$, which means that $P \in (0, \frac{\pi}{2})$ or $P \in \left(\frac{\pi}{2}, \frac{\pi}{2 \sin \lambda_f c_f} \right)$.

$$\tau_v = \min \left\{ \tau_f, \frac{\pi}{2 \sin \lambda_f c_f} - (\varepsilon_P + \varepsilon_\tau) \right\}, \quad (4.128)$$

$\varepsilon_\tau > 0$ such that $\tau_v > 0$.

Second Case: $\lambda_f c_f = \frac{\pi}{2}$

Since $\lambda_v c_v \leq \lambda_\omega c_\omega < \frac{\pi}{2}$, one cannot attain the upper bound $\lambda_f c_f$ if $\lambda_f c_f = \frac{\pi}{2}$ in (4.123). But we can make $\lambda_v c_v$ arbitrarily close to $\frac{\pi}{2}$ with

$$P = \frac{\pi}{2}, Q = \lambda_f, \quad (4.129)$$

from which

$$\begin{aligned} \lambda_v c_v &= \min \left\{ \lambda_f, Q \right\} \min \left\{ c_f, \frac{\pi - 2\varepsilon_c Q}{2Q} \right\} \\ &= \lambda_f \min \left\{ c_f, \frac{\pi - 2\varepsilon_c Q}{2Q} \right\} \\ &= \frac{\pi - 2\varepsilon_c Q}{2}. \end{aligned} \quad (4.130)$$

$$\lambda_v = \lambda_f, \quad (4.131)$$

$$c_v = \frac{\pi - 2\varepsilon_c \lambda_f}{2\lambda_f}, \quad (4.132)$$

where ε_τ and ε_c are positive numbers such that $\tau_v > 0$ and $c_v > 0$.

From (4.92) and (4.93), Tanaka *et al.* [32] pointed out that the assumption on f is that it decays double exponentially only on the real line. Stenger's assumption [27] is that f decays not only single exponentially on the real line but also on the strip region \mathcal{D}_c , i.e. $f \in \mathbf{L}_\alpha(\mathcal{D}_c)$ for $\alpha, c > 0$ and $\mathbf{L}_\alpha(\mathcal{D}_c)$ satisfies

$$|f(z)| \leq K \frac{e^{|\alpha z|}}{(1 + |e^z|)^{2\alpha}}, \quad \forall z \in \mathcal{D}_c, K > 0. \quad (4.133)$$

Chapter 5

Computational Examples

He who wants to eat honey that is embedded inside the rock cannot afford to look anxiously at the edge of his axe.

Nigerian proverb.

In this chapter, we shall be applying the four quadrature formulas derived in chapters 3 and 4 to find numerical approximations to two test problems. In doing this, we shall attempt to show how the parameters for finding the step size h for each of the formulas can be obtained. We shall also illustrate using figures, the actual form of the error by plotting the actual error against v in each case for each of the formulas, as well as plotting the error against $\phi^{-1}(v)$. This stretches out the ends of the interval $-1 < v < 1$ so that the true behaviour of v near the end-point singularities is shown more clearly.

The chapter concludes with a performance evaluation and an analysis of the results. The octave and gnuplot codes used for each of the computations and figures respectively can be found in Akinola [3].

5.1 Implementing Haber's Formula A

Example 5.1. Let us use formula (3.64) to approximate the integral below:

$$\int_{-1}^v \frac{1}{\pi\sqrt{1-x^2}} dx. \quad (5.1)$$

Let us first find the values of the parameters α and c , bearing in mind that they are to be chosen so that the functions are "normalised". To find α , we shall use condition \mathbf{A}_4 with $\phi(x) = \tanh \frac{x}{2}$, $\phi'(x) = \frac{1}{2} \operatorname{sech}^2 \frac{x}{2}$:

$$\begin{aligned} f(\phi(x)) &= \frac{1}{\pi\sqrt{1-\tanh^2 \frac{x}{2}}} = \frac{1}{\pi \operatorname{sech} \frac{x}{2}} \\ f(\phi(x))\phi'(x) &= \frac{1}{2\pi \cosh \frac{x}{2}} \\ |f(\phi(x))\phi'(x)| &= \left| \frac{1}{2\pi \cosh \frac{x}{2}} \right| \\ &= O(e^{-\frac{1}{2}|x|}), \quad |x| \rightarrow \infty, \end{aligned} \quad (5.2)$$

which implies that $\alpha = \frac{1}{2}$. From Theorem 3.8, we can choose $0 < c \leq \pi$ and, for this example, we chose $c = \pi$. We used 376 values of v , which are

$$\begin{aligned} V = & -0.999, -0.998, -0.997, \dots, -0.9; -0.89, -0.88, -0.87, \dots, +0.96; \\ & +0.911, +0.912, +0.913, \dots, +0.999. \end{aligned}$$

We plugged these values of v, α, c into (3.64), we present results by Figure 5.1, Figure 5.2 and Table 5.1.

Figure 5.1 shows some oscillations that increase toward the endpoint singularities (± 1), but the behaviour towards ± 1 is shown clearly in Figure 5.2. From Figure 5.1, it is quite difficult to see the maximum absolute value of the error of applying Haber's formula A, thus we decided to plot Figure 5.3 ($v \in [-0.8, -1]$) to

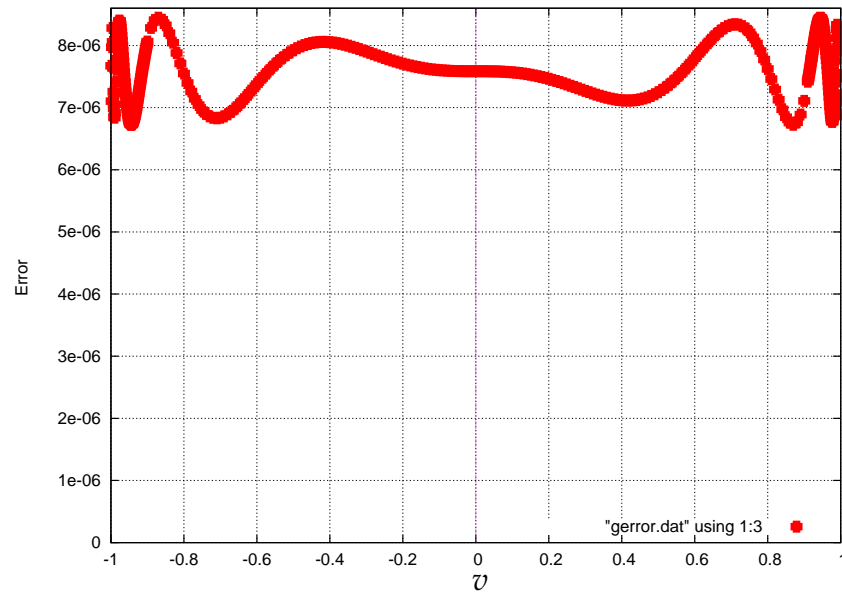

Figure 5.1: The error against v for $\int_{-1}^v \frac{1}{\pi\sqrt{1-x^2}} dx$, $N = 25$, using Haber's formula A.

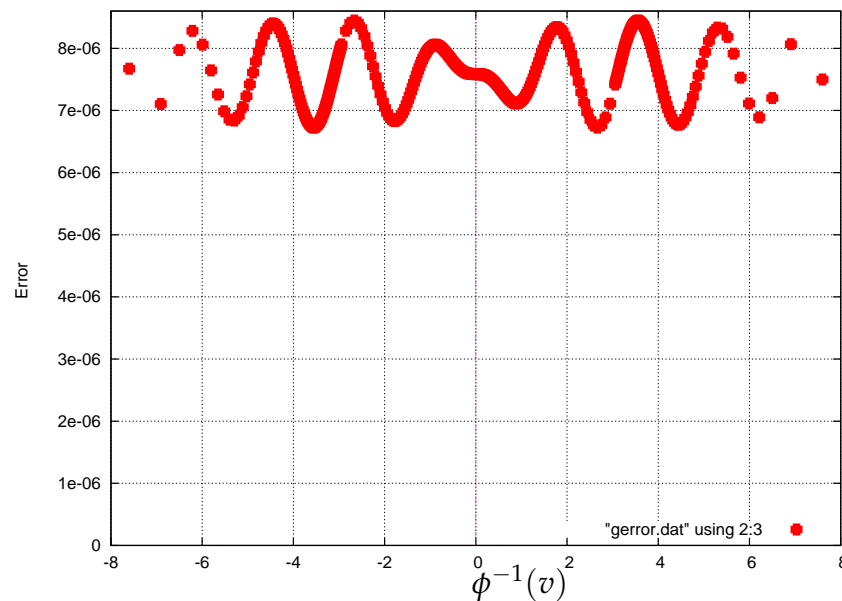

Figure 5.2: The error against $\phi^{-1}(v)$ for $\int_{-1}^v \frac{1}{\pi\sqrt{1-x^2}} dx$, $N = 25$, using Haber's formula A.

show that it occurs at $v = -0.87$.

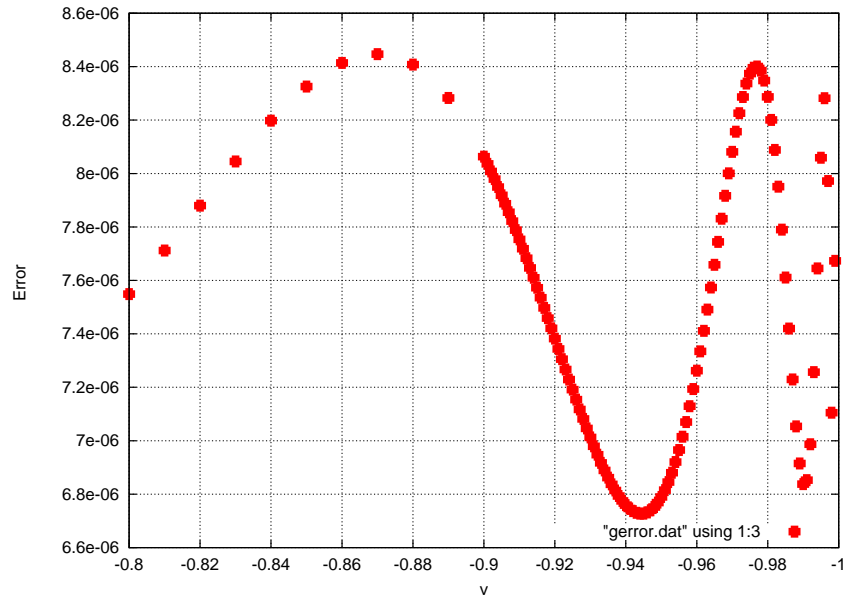

Figure 5.3: The error against v for $\int_{-1}^v \frac{1}{\pi\sqrt{1-x^2}} dx$, $N = 25$, using Haber's formula A.

Example 5.2. Let us use formula (3.64) to approximate the integral below:

$$\frac{1}{4 \log 2} \int_{-1}^v \log \left(\frac{1+x}{1-x} \right) dx. \quad (5.3)$$

We shall do this by finding the value of α , using condition \mathbf{A}_4 with $\phi(x) = \tanh \frac{x}{2}$, $\phi'(x) = \frac{1}{2} \operatorname{sech}^2 \frac{x}{2}$, so that

$$f(\phi(x)) = \frac{1}{4 \log 2} \log \left(\frac{1 + \tanh \frac{x}{2}}{1 - \tanh \frac{x}{2}} \right).$$

After some algebra using the exponential form of $\tanh \frac{x}{2}$, one obtains

$$\begin{aligned}
 f(\phi(x)) &= \frac{1}{4 \log 2} \log e^x = \frac{x}{4 \log 2} \\
 f(\phi(x))\phi'(x) &= \frac{x}{4 \log 2} \times \frac{1}{2} \operatorname{sech}^2 \frac{x}{2} \\
 &= \frac{x}{8 \log(2) \cosh^2 \frac{x}{2}} \\
 &= \frac{x}{2 \log(2) (e^{\frac{x}{2}} + e^{-\frac{x}{2}})^2} \\
 |f(\phi(x))\phi'(x)| &\leq O(e^{-|x|}), \quad |x| \rightarrow \infty.
 \end{aligned} \tag{5.4}$$

As in Example 5.1, 376 values of v were used with $\alpha = 1$. These values of v, α, c were substituted into (3.64), results are presented by Figures 5.4 and 5.5 as well as Table 5.2.

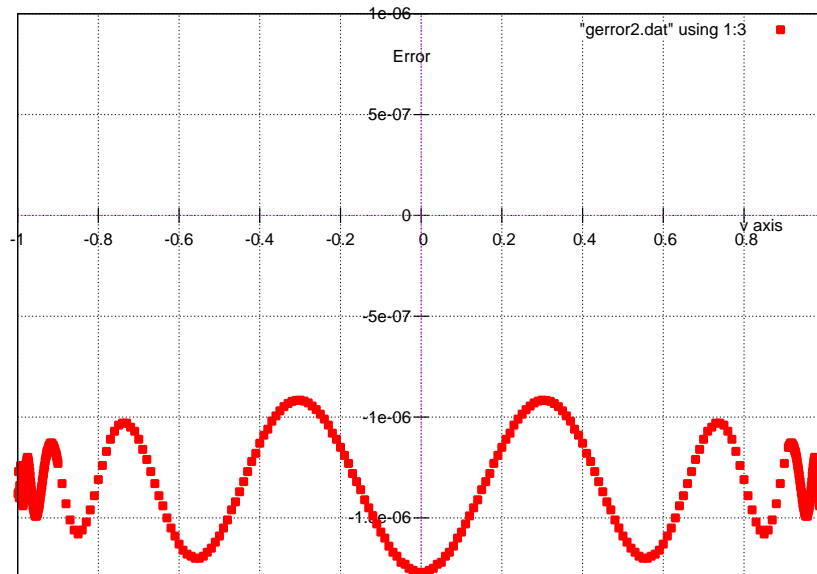

Figure 5.4: The error against v for $\frac{1}{4 \log 2} \int_{-1}^v \log \left(\frac{1+x}{1-x} \right) dx$, $N = 25$, using Haber's formula A.

A close look at Figure 5.4 shows a dying oscillation as v tends to ± 1 , which means that the maximum absolute value of the error decreases towards the end-

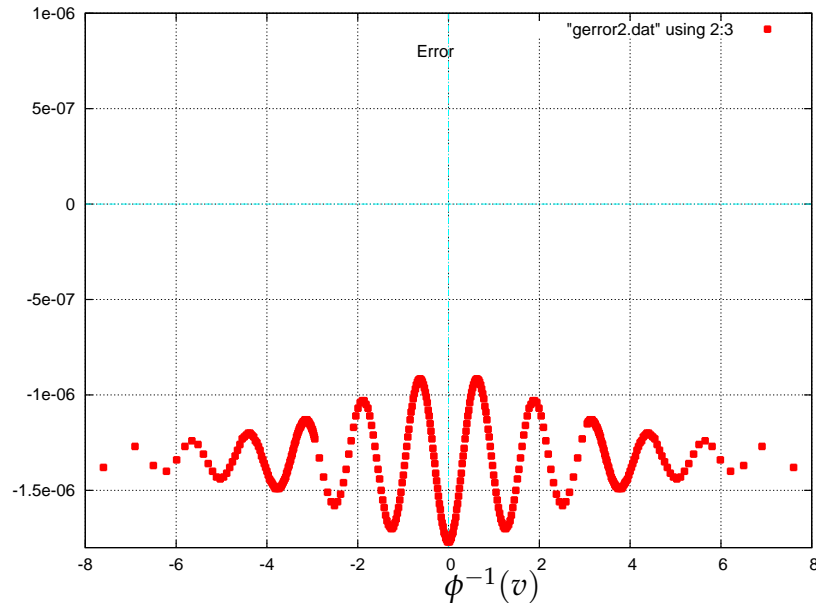

Figure 5.5: The error against $\phi^{-1}(v)$ for $\frac{1}{4 \log 2} \int_{-1}^v \log \left(\frac{1+x}{1-x} \right) dx$, $N = 25$, using Haber's formula A.

points. The maximum absolute value of the error for Haber's formula A on the integrand $\frac{1}{4 \log 2} \int_{-1}^v \log \left(\frac{1+x}{1-x} \right) dx$ occurs at $v = 0$, as shown in Figure 5.4.

5.2 Implementing Haber's Formula B

We shall try to implement Haber's Formula B on the integrals (5.1) and (5.3). From Haber's condition A_4 , they both decay single exponentially. The same analysis is applicable to the two integrals in the previous section, the only difference being that we use an auxiliary function $\varphi(x) = \frac{x+1}{2}$.

Example 5.3. From the right-hand side of equation (5.2), with $\alpha = \frac{1}{2}$, $c = \pi$ and using the auxiliary function $\varphi(x) = \frac{x+1}{2}$, we substituted these values into (3.75), which is Haber's Formula B. Table 5.1 shows the values of N used and the maximum error. (See also Figures 5.6 and 5.7).

The oscillations in Figure 5.6 are higher around $v = 0$ and decreases towards

± 1 . From Figure 5.8, we can see that the maximum absolute value of the error occurs at $v = -0.18$.

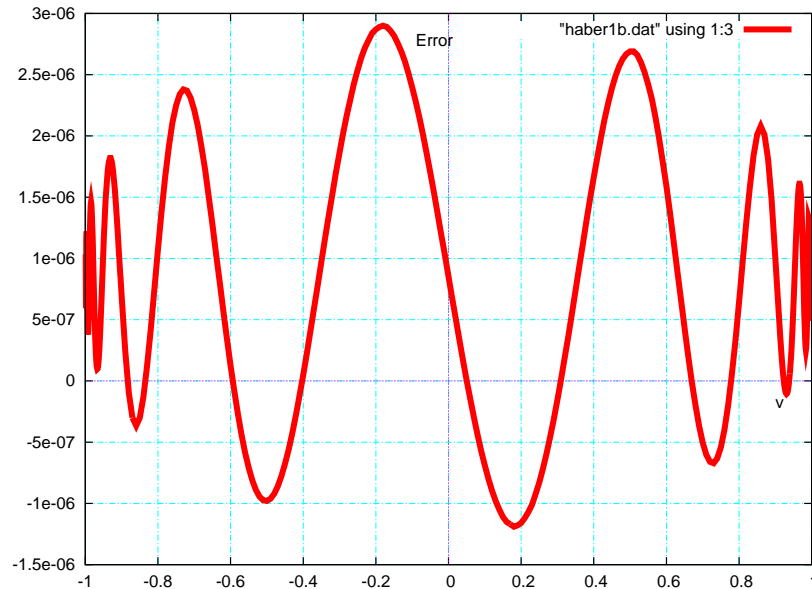

Figure 5.6: The error against v for $\int_{-1}^v \frac{1}{\pi\sqrt{1-x^2}} dx$, $N = 36$, using Haber's formula B.

Example 5.4. From the right-hand side of equation (5.4), with $\alpha = 1$, $c = \pi$ and using the auxiliary function $\varphi(x) = \frac{x+1}{2}$, we then substituted these values into (3.75), which is Haber's Formula B. The results are tabulated in Table 5.2 and illustrated by Figure 5.9 and Figure 5.10.

As can be seen in Figure 5.9, the oscillations decrease towards the endpoints, but Fig 5.10 stretches the original figure like an "ideal spring". The maximum absolute error occurs at $v = 0$.

5.3 Implementing the SE Formula

We shall use the integral in Examples 5.1 and 5.2 (they decay single exponentially) to implement the Single Exponential Formula.

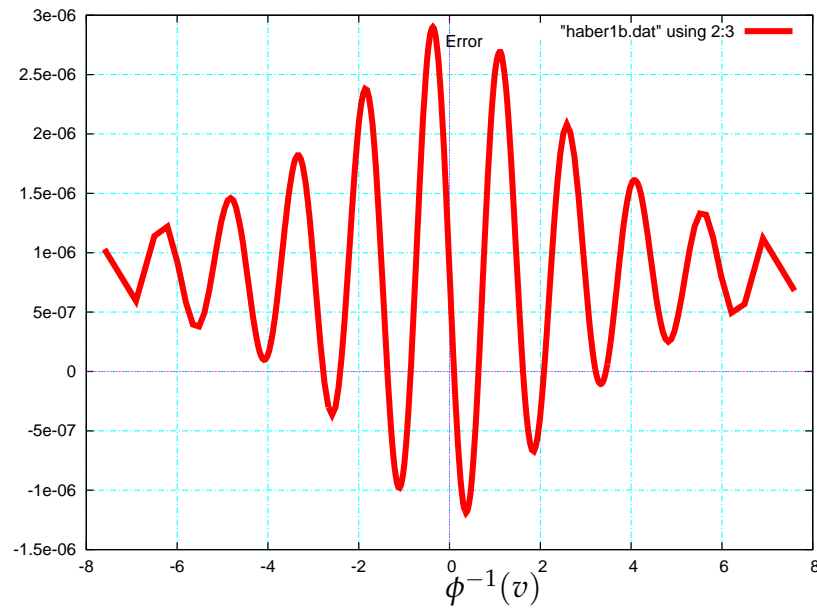

Figure 5.7: The error against $\phi^{-1}(v)$ for $\int_{-1}^v \frac{1}{\pi\sqrt{1-x^2}} dx$, $N = 36$, using Haber's formula B.

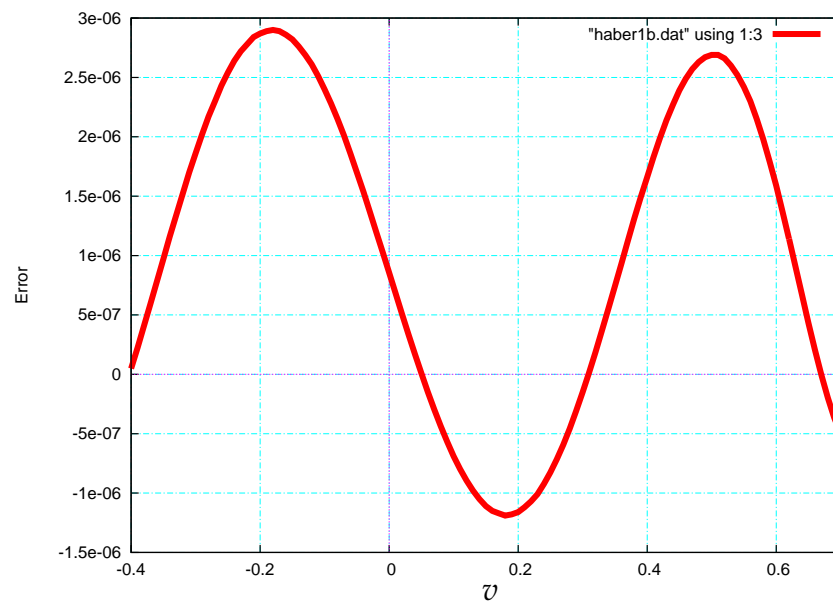

Figure 5.8: The error against v for $\int_{-1}^v \frac{1}{\pi\sqrt{1-x^2}} dx$, $N = 36$, using Haber's formula B.

Example 5.5. As already shown with Example 5.1, we can deduce that $\alpha_f = \frac{1}{2}$, and using

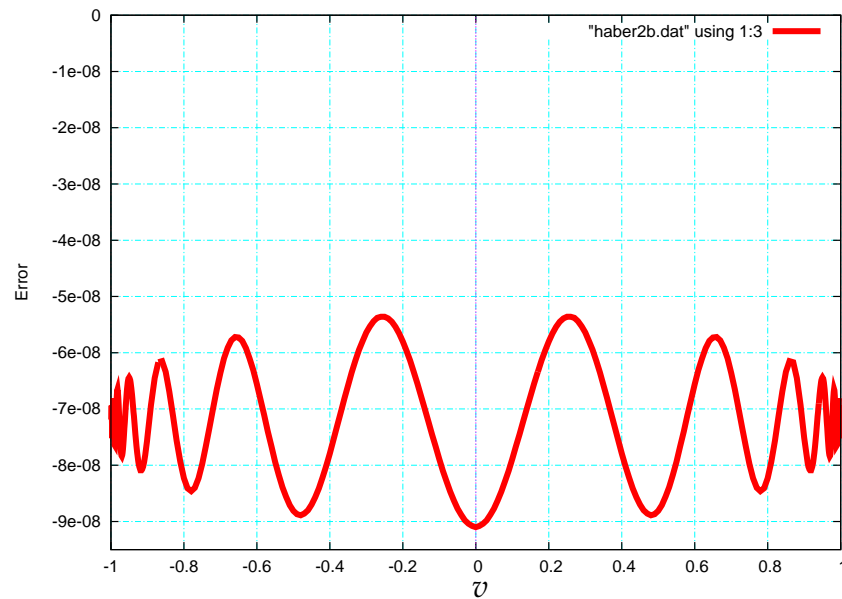

Figure 5.9: The error against v for $\frac{1}{4 \log 2} \int_{-1}^v \log \left(\frac{1+x}{1-x} \right) dx$, $N = 36$, using Haber's formula B.

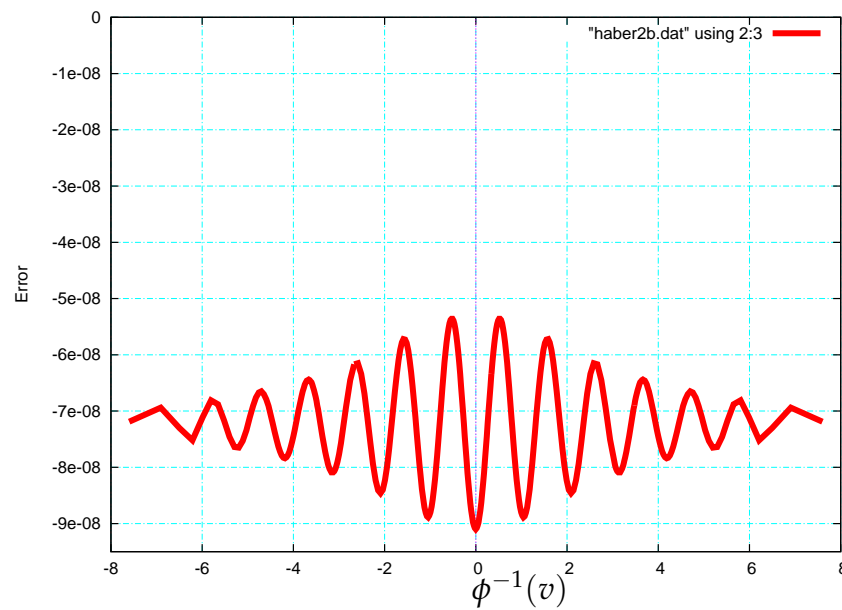

Figure 5.10: The error against $\phi^{-1}(v)$ for $\frac{1}{4 \log 2} \int_{-1}^v \log \left(\frac{1+x}{1-x} \right) dx$, $N = 36$, using Haber's formula B.

(4.31), one will find that $\tau = \frac{1}{4}$, $\alpha'_f = \min\left(\frac{1}{2}, 2\left(\frac{1}{4}\right)\right) = \frac{1}{2}$, $c'_f = \min(c_f, 2\pi - \varepsilon_c) = \pi - \varepsilon$ when $\varepsilon_c = \varepsilon$. Substituting these values into (4.29) we have that

$$h = \sqrt{\frac{2\pi(\pi - \varepsilon)}{N}}.$$

These values are then plugged into the SE formula (4.54), as are the 376 values of v (see Table 5.1, Figure 5.11 and Figure 5.12).

By looking at Figure 5.11 we find that the oscillations increase toward ± 1 . We plotted the figure with the gnuplot histeps option, because the other options did not join the point $v = 0$ with the other points, which is why the figure appears different to the other figures. A plot within the interval $[-1, -0.9]$, similar to that in Figure 5.3, shows that the maximum absolute value of the error occurs at $v = -0.933$.

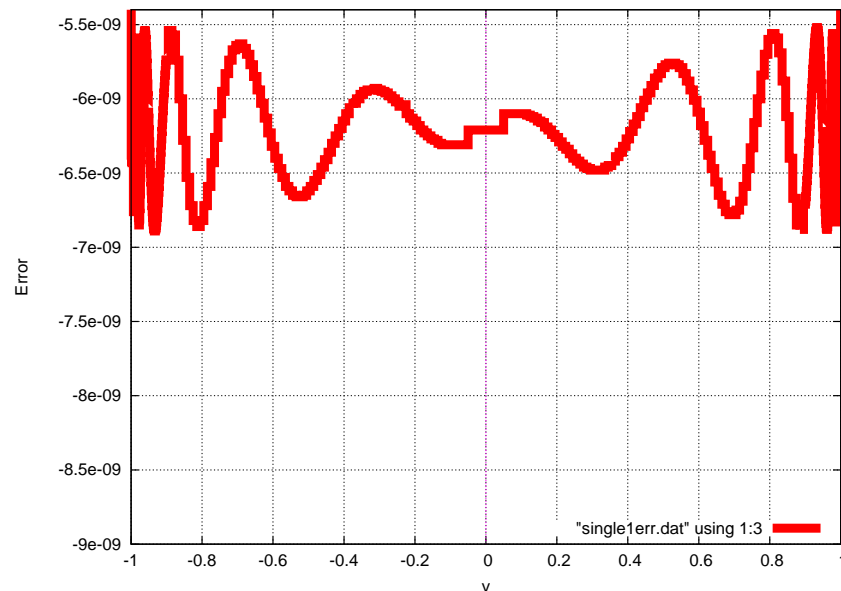

Figure 5.11: Error against v for $\int_{-1}^v \frac{1}{\pi\sqrt{1-x^2}} dx$, $N = 64$, using the SE formula.

Example 5.6. From our analysis of the integral in Example 5.2,

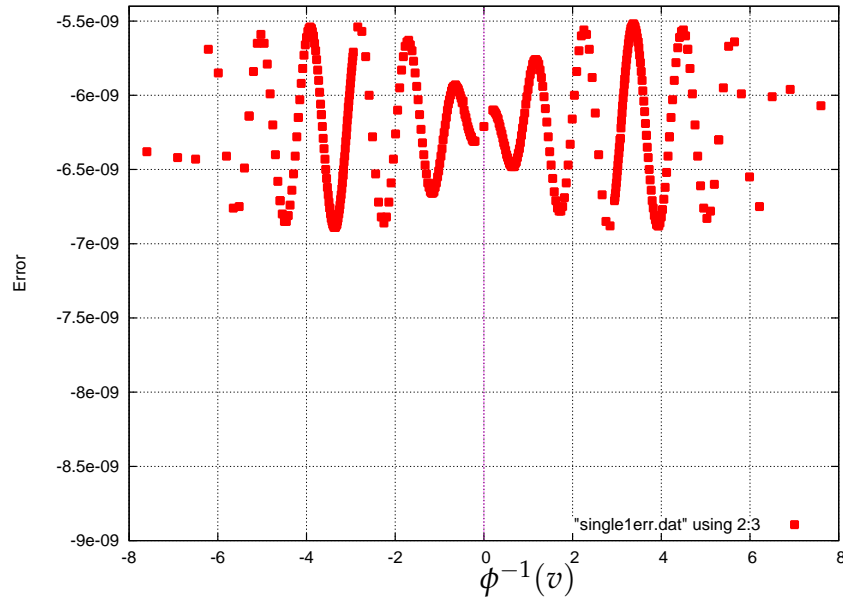

Figure 5.12: Error against $\phi^{-1}(v)$ for $\int_{-1}^v \frac{1}{\pi\sqrt{1-x^2}} dx$, $N = 64$, using the SE formula.

$\frac{1}{4 \log 2} \int_{-1}^v \log \left(\frac{1+x}{1-x} \right) dx$, we will take $\alpha_f = 1$, and from (4.29) and (4.31) we use $\tau = \frac{1}{2}$, $c'_f = \pi - \varepsilon_c = \pi - \varepsilon$, when $\varepsilon_c = \varepsilon$, $\alpha'_f = \min(1, 1) = 1$:

$$h = \sqrt{\frac{\pi(\pi - \varepsilon)}{N}}.$$

The values obtained above, with the step size, are then substituted into (4.54) (Refer to Table 5.2, Figure 5.13 and Figure 5.14).

Figure 5.13 shows that the maximum absolute value of the error occurs at $v = 0$. It also shows that the maximum absolute error decreases towards ± 1 .

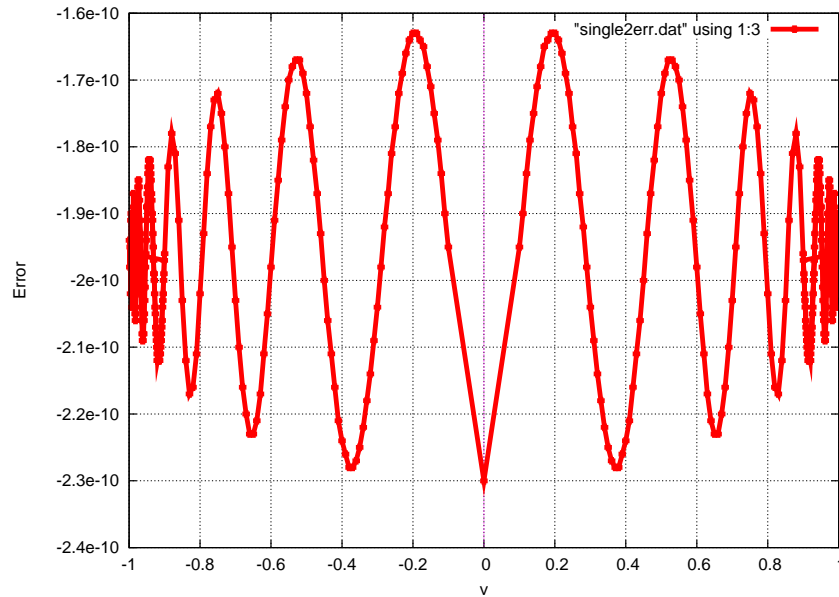

Figure 5.13: Error against v for $\frac{1}{4 \log 2} \int_{-1}^v \log \left(\frac{1+x}{1-x} \right) dx$, $N = 64$, using the SE formula.

5.4 Implementing Tanaka *et al.*'s Formula

Example 5.7. We want to use formula (4.112) to approximate the integral in Example 5.1 with $\phi_1(x) = \tanh \left(\frac{\pi}{2} \sinh x \right)$.

$$\begin{aligned}
 f(x) &= \frac{1}{\pi \sqrt{1-x^2}} = O(|1-x^2|^{-\frac{1}{2}}); \quad (x \rightarrow \pm 1) \\
 f(\phi_1(x))\phi_1'(x) &= \frac{1}{\pi \sqrt{1 - \tanh^2 \left(\frac{\pi}{2} \sinh x \right)}} \frac{\pi \cosh x}{2 \cosh^2 \left(\frac{\pi}{2} \sinh x \right)} \\
 &= \frac{\cosh x}{2 \operatorname{sech} \left(\frac{\pi}{2} \sinh x \right) \cosh^2 \left(\frac{\pi}{2} \sinh x \right)} \\
 &= \frac{\cosh x}{2 \cosh \left(\frac{\pi}{2} \sinh x \right)} \\
 |f(\phi_1(x))\phi_1'(x)| &= O(\exp(-\frac{\pi}{4} \exp |x|)); \quad (x \rightarrow \pm \infty).
 \end{aligned}$$

Comparing this with the right-hand side of the expression $|f(x)| \leq \alpha_f \exp(-\tau_f \exp(\lambda_f |x|))$,

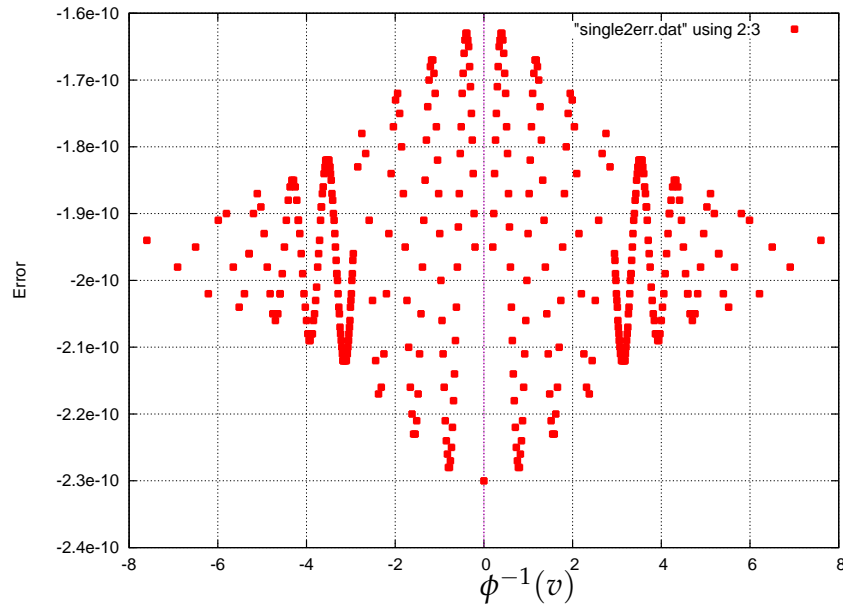

Figure 5.14: Error against $\phi^{-1}(v)$ for $\frac{1}{4 \log 2} \int_{-1}^v \log \left(\frac{1+x}{1-x} \right) dx$, $N = 64$, using the SE formula.

one finds that

$$\tau_f = \frac{\pi}{4}, \lambda_f = 1; \quad c_f = \frac{\pi}{2Q} - \varepsilon_c = \frac{\pi}{2} - \varepsilon_c;$$

and using (4.124) to (4.128), $Q = \lambda_f = \lambda_v = 1$, $\tau_v = \frac{\pi}{4}$, $c_v = \frac{\pi}{2} - \varepsilon_c$;

$$P = \frac{\pi}{2 \sin(\frac{\pi}{2} - \varepsilon_c)} - \varepsilon_P; \quad \varepsilon_P > 0 \ni P > 0. \quad (5.5)$$

For any small ε_c , $\sin(\frac{\pi}{2} - \varepsilon_c) \equiv 1$ and P may be close to $\frac{\pi}{2}$, thus $P = \frac{\pi}{2} - \varepsilon$ must be chosen when $\varepsilon_P = \varepsilon$ and, making the appropriate substitutions,

$$h = \frac{\log(\pi(c_v - \varepsilon)\lambda_v N / \tau_v)}{\lambda_v N} = \frac{\log((2\pi - 8\varepsilon)N)}{N}.$$

(Refer to Table 5.1, Figure 5.15 and Figure 5.16). Figure 5.15 displays no oscillations and, in contrast to the other figures, we see a clustering around zero, except

at $v = 0.911$, which is the maximum absolute value of the error and at $v = -0.25$.

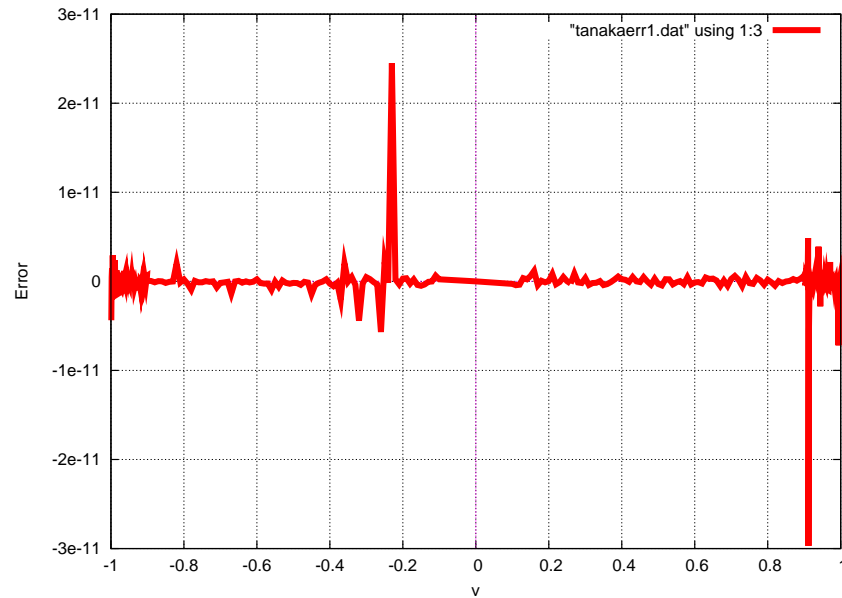

Figure 5.15: The error against v for $\int_{-1}^v \frac{1}{\pi\sqrt{1-x^2}} dx$, $N = 64$, using Tanaka *et al.*'s formula.

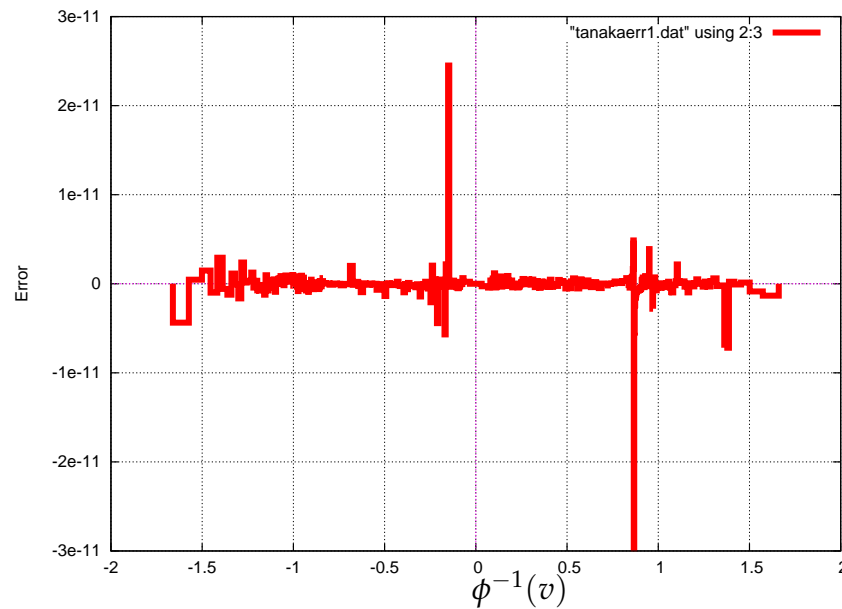

Figure 5.16: The error against $\phi^{-1}(v)$ for $\int_{-1}^v \frac{1}{\pi\sqrt{1-x^2}} dx$, $N = 64$, using Tanaka *et al.*'s formula.

Example 5.8. We want to use formula (4.112) to approximate the integral

$$\frac{1}{4 \log 2} \int_{-1}^v \log \left(\frac{1+x}{1-x} \right) dx. \quad (5.6)$$

We illustrate how to obtain the parameters below.

$$\begin{aligned} f(\phi_1(x))\phi_1'(x) &= \frac{1}{4 \log 2} \log \left(\frac{1 + \tanh(\frac{\pi}{2} \sinh x)}{1 - \tanh(\frac{\pi}{2} \sinh x)} \right) \frac{\pi \cosh x}{2 \cosh^2(\frac{\pi}{2} \sinh x)} \\ &= \frac{\pi \log(\exp(\pi \sinh x)) \cosh x}{8 \log 2 \cosh^2(\frac{\pi}{2} \sinh x)} \\ &= \frac{\pi^2 \sinh x \cosh x}{8 \log 2 \cosh^2(\frac{\pi}{2} \sinh x)} \\ |f(\phi_1(x))\phi_1'(x)| &= O(\exp(-\frac{\pi}{2} \exp(|x|))), \quad x \rightarrow \pm\infty. \end{aligned}$$

Thus $|f(\phi_1(x))\phi_1'(x)|$ decays double exponentially with $\tau_f = \frac{\pi}{2}$, $\lambda_f = 1$. Using (4.124) to (4.128), $P = \frac{\pi}{2}$, $\lambda_v = 1$, $\tau_v = \min \left\{ \frac{\pi}{2}, \frac{\pi}{2} - (\varepsilon_P - \varepsilon_\tau) \right\} = \min \left\{ \frac{\pi}{2}, \frac{\pi}{2} - 2\varepsilon \right\} = \frac{\pi}{2} - 2\varepsilon$, $c_v = \frac{\pi}{2} - \varepsilon_c = \frac{\pi}{2} - \varepsilon$ and

$$h = \frac{\log(\pi(c_v - \varepsilon)\lambda_v N / \tau_v)}{\lambda_v N} = \frac{\log \pi N}{N}.$$

A closer look at Figure 5.17 shows a clustering or increase in the error towards +1. Figure 5.18, which is supposed to stretch the plot so that we can see the behaviour towards the end-points, does not really help. So for us to trully see the maximum value of the error $v = 0.994$, and the behaviour towards +1, we plotted Figure 5.19, on the interval $[0.9, 1]$.

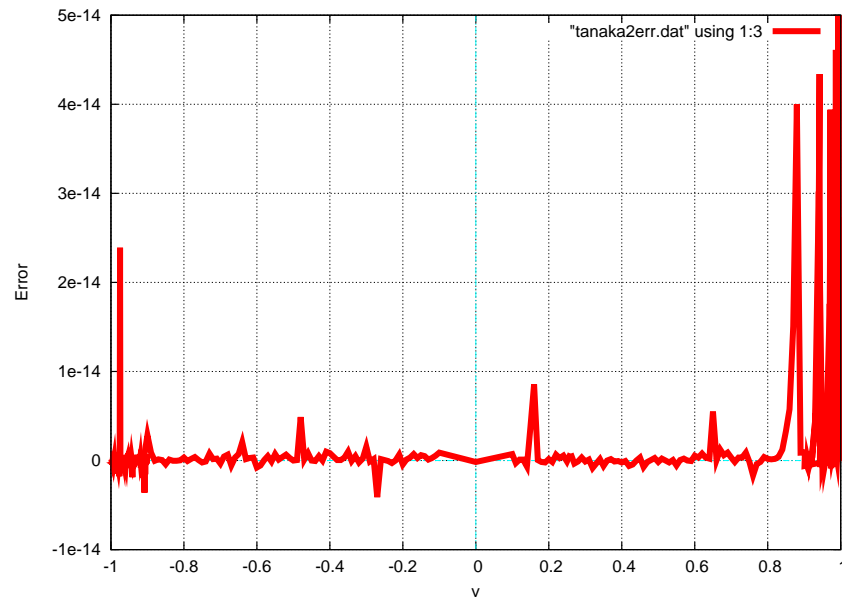

Figure 5.17: The error against v for $\frac{1}{4 \log 2} \int_{-1}^v \log \left(\frac{1+x}{1-x} \right) dx$, $N = 49$, using Tanaka *et al.*'s formula.

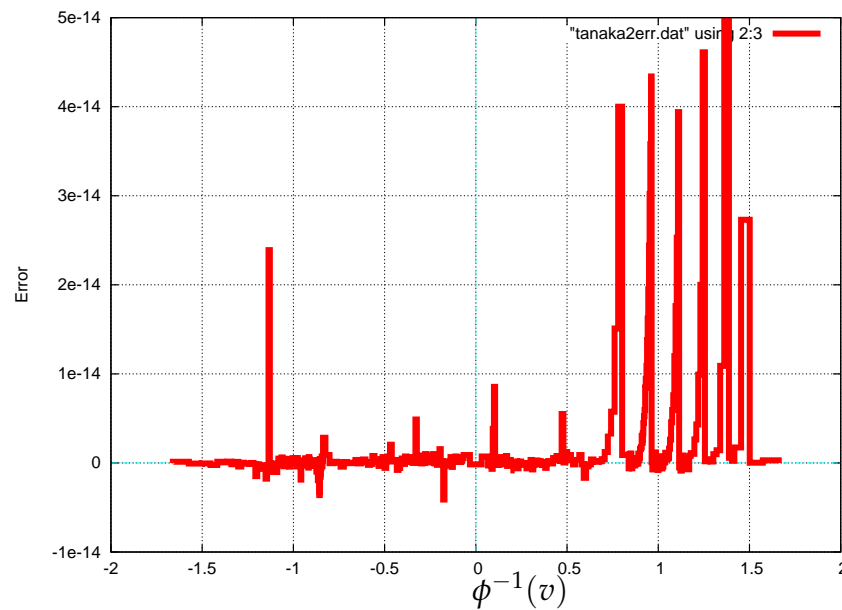

Figure 5.18: The error against $\phi^{-1}(v)$ for $\frac{1}{4 \log 2} \int_{-1}^v \log \left(\frac{1+x}{1-x} \right) dx$, $N = 49$, using Tanaka *et al.*'s formula.

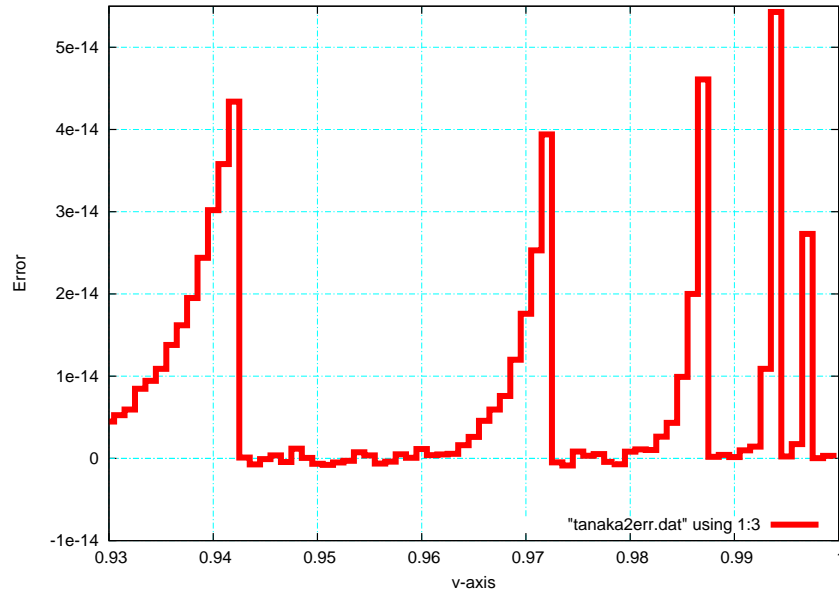

Figure 5.19: The error against v for $\frac{1}{4 \log 2} \int_{-1}^v \log \left(\frac{1+x}{1-x} \right) dx$, $N = 49$, using Tanaka *et al.*'s formula.

5.5 Performance Evaluation and Analysis of Results

After deriving and showing how to implement the four quadrature formulas for numerical approximation to indefinite integrals based on the sinc method in chapters 3 and 4, and in the earlier part of this chapter, this section will be concerned with the assertion of the performances of the methods on the computational examples. This will be done by comparing the maximum absolute errors of the four quadrature formulas. In each table, "Max. Error" represents the maximum absolute value of the error of the approximation for the values of v for which the integral was evaluated, and N represents the number of function evaluations.

From Table 5.1, we discover that, for $N \geq 81$, there was a blow up for Haber's formulas A and B for the reason given in the final paragraph of section 3.6. This blow up is illustrated in Figure 5.20 by the vertical line going downwards at $N = 64$. In addition, one can see that Tanaka *et al.*'s formula gives the most accurate results as N becomes larger. However, Stenger's SE formula perform better than

N	Max. Error			
	Haber's A	Haber's B	SE	Tanaka
1	5.92e-02	1.08e-01	7.15e-02	2.88e-01
4	5.80e-03	1.70e-02	5.37e-03	1.08e-02
9	6.67e-04	2.09e-03	4.37e-04	1.07e-04
16	7.58e-05	2.36e-04	4.90e-05	2.84e-07
25	8.45e-06	2.63e-05	5.25e-06	1.78e-10
36	9.34e-07	2.90e-06	5.78e-07	2.97e-11
49	1.03e-07	3.18e-07	6.29e-08	2.97e-11
64	1.13e-08	3.48e-08	6.89e-09	2.97e-11
81			7.51e-10	2.97e-11
100			1.08e-10	2.97e-11

Table 5.1: The maximum error of the formulas on $\int_{-1}^v \frac{1}{\pi\sqrt{1-x^2}} dx$.

the Haber's formulas and did not blow up at $N = 64$.

N	Max. Error			
	Haber's A	Haber's B	SE	Tanaka
1	1.67e-01	1.67e-01	1.66e-01	2.24e-01
4	1.06e-02	1.06e-02	1.06e-02	9.83e-03
9	6.01e-04	6.01e-04	6.03e-04	6.18e-05
16	3.35e-05	3.35e-05	3.38e-05	8.13e-08
25	1.77e-06	1.77e-06	1.79e-06	3.54e-11
36	9.10e-08	9.10e-08	9.25e-08	5.39e-14
49	4.55e-09	4.55e-09	4.65e-09	5.43e-14
64	2.24e-10	2.24e-10	2.30e-10	5.43e-14
81	1.08e-11	1.08e-11	1.12e-11	5.41e-14
100	5.20e-13	5.20e-13	5.40e-13	5.42e-14

Table 5.2: The maximum error of the formulas on $\frac{1}{4\log 2} \int_{-1}^v \log\left(\frac{1+x}{1-x}\right) dx$.

A close look at Table 5.2 shows that Tanaka *et al.*'s formula gives more accurate results than the other formulas as well as a faster convergence to the exact solution. Figure 5.21 shows that the maximum absolute errors for the other three formulas coincide, indicating that they give almost the same results to a certain degree of accuracy on the integral $\frac{1}{4\log 2} \int_{-1}^v \log\left(\frac{1+x}{1-x}\right) dx$.

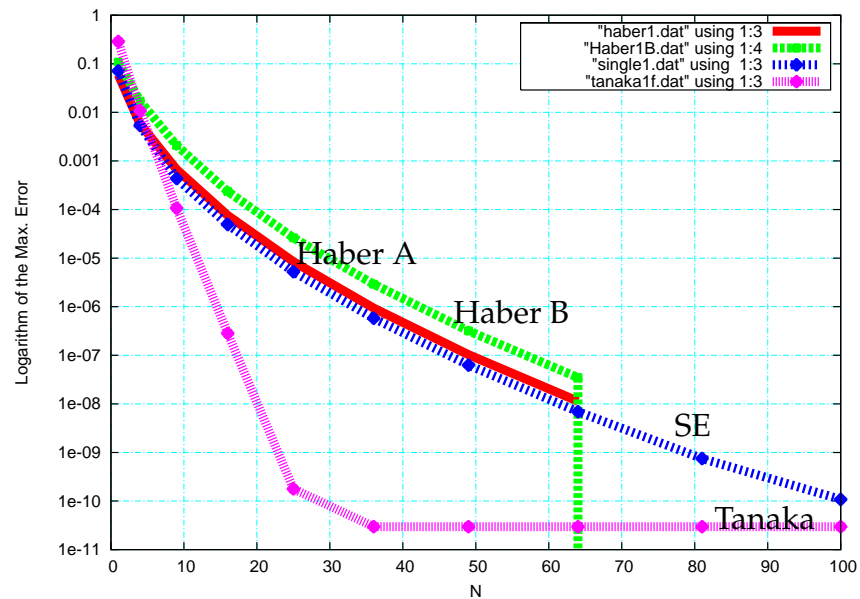

Figure 5.20: The logarithm of the maximum absolute error against N on $\int_{-1}^v \frac{1}{\pi\sqrt{1-x^2}} dx$.

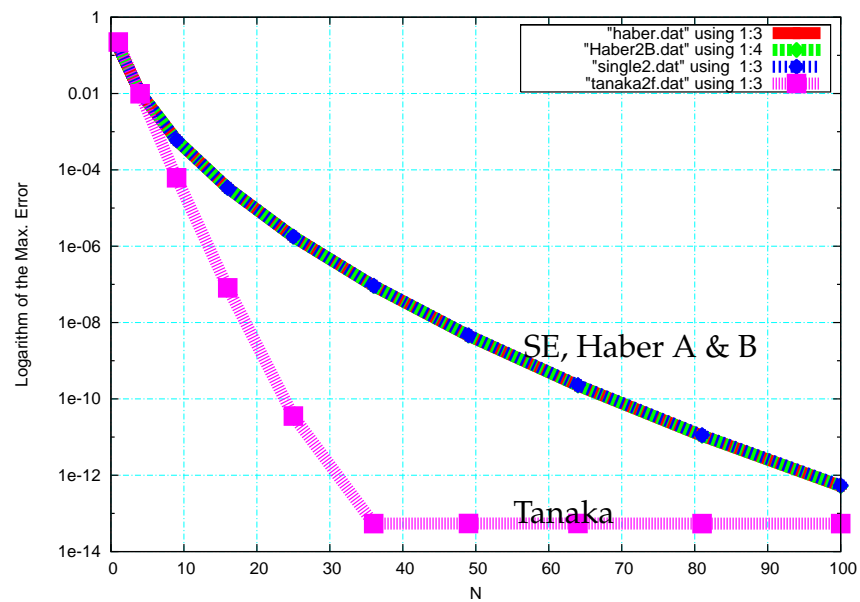

Figure 5.21: The logarithm of the maximum absolute error against N on $\frac{1}{4 \log 2} \int_{-1}^v \log \left(\frac{1+x}{1-x} \right) dx$.

Chapter 6

ODE Solvers

What an old man sees while stooping, a child cannot see even if he climbs a tree.

Nigerian proverb

This chapter asks and answers the question: Can one convert the indefinite integral to an ordinary differential equation (ODE) with suitable initial conditions? If yes, why bother with the derivation of the formulas for numerical indefinite integration instead of using software packages such as Matlab[®] ode45 and Mathematica[®] NDSolve to solve the initial value problem? Finally, the chapter ends with a conclusion as well as recommendation for further study.

6.1 Initial Value Problems

In this section, we shall illustrate how to transform the indefinite integrals in our test problems into an ODE. Let I be a finite interval and f an integrable function that is defined on I . The integral from any fixed number [33] $c \in I$ to another

number $x \in I$ then defines a new function F , whose value at x is

$$F(x) = \int_c^x f(u) \, du. \quad (6.1)$$

For each x that one inputs, there is a well-defined numerical output, which is the definite integral of f from c to x .

Equation (6.1) can be used to show a connection between integrals and derivatives. For a continuous function f , the Fundamental Theorem of Calculus illustrates that F is a differentiable function of x , of which its derivative is f itself. For all $x \in \mathbb{R}$,

$$\frac{d}{dx}F(x) = \frac{d}{dx} \int_c^x f(u) \, du = f(x). \quad (6.2)$$

Hence the corresponding initial value problem becomes $F'(x) = f(x)$, $F(-1) = 0$.

This is now stated in the form of a theorem [33] without proof:

Theorem 6.1. *If f is continuous on $[c, d]$, then $F(x) = \int_c^x f(u) \, du$ is continuous there and differentiable [33] on (c, d) , and its derivative is $f(x)$:*

$$\begin{aligned} F'(x) &= \frac{d}{dx} \int_c^x f(u) \, du \\ &= f(x). \end{aligned} \quad (6.3)$$

In summary, $F(x) = \int_{-1}^x f(u) \, du$ satisfies the initial value problem $F'(x) = f(x)$, $F(-1) = 0$.

Applying the above theory to the integrals in question, we have

$$\begin{aligned}
 y(x) &= \int_{-1}^x \frac{1}{\pi\sqrt{1-v^2}} dv \\
 \frac{d}{dx}y(x) &= \frac{d}{dx} \int_{-1}^x \frac{1}{\pi\sqrt{1-v^2}} dv \\
 y'(x) &= \frac{1}{\pi\sqrt{1-x^2}} \\
 \frac{dy}{dx} &= \frac{1}{\pi\sqrt{1-x^2}}; \quad y(-1) = 0.
 \end{aligned}$$

But using mathematical software such as Mathematica[®] NDSolve, Matlab[®] ode45, octave lsode, we could not obtain any solution, since at $x = -1$, the function has an algebraic singularity.

Similarly, for the initial value problem

$$\frac{dy}{dx} = \frac{1}{4 \log 2} \log \left(\frac{x+1}{1-x} \right); \quad y(-1) = 0,$$

it was not possible to obtain any solution because of the logarithmic singularity.

Therefore, the answer to the question posed at the beginning of this chapter is in the affirmative, but numerical software packages cannot be used to solve the initial value problems because the integrands in our test problems have singularities.

We remark that though ODE solvers failed in solving the resulting IVPs, we can carry out DE transformations in line with Nurm Muhammad *et al.* [22] to solve them.

Nurm Muhammad, Muhammad and Mori [22] employed the technique of transforming the differential equation into a Volterra integral equation. Once this is done, the integral equation can now be solved using Tanaka *et al.*'s formula [32]. This involves solving a system of linear and non-linear algebraic equations of which the solution gives approximate solution to the differential equation. The

DE variable transformation technique involved has the advantage of giving accurate results [22] for IVPs with end point singularities as well as stiff problems.

6.2 Conclusions

We have succeeded in the main aim of this thesis: which was to show the analysis leading to the derivation of the four quadrature formulas for numerical indefinite integration using the sinc method. We have also showed how to implement the four quadrature formulas on two computational examples.

Due to the improvement in software development, one can simply type `Si(x)` in octave to compute the values of the sine integral, as opposed to using the algorithm given in the appendix of Haber's paper [11]. We have also showed the justification of the expression for the step size $h = \sqrt{\pi c / \alpha N}$, used to approximate integrands that decay single exponentially. In addition, after the integrals have been converted to differential equations, we have illustrated the failure of existing numerical ODE solvers in solving the resulting differential equations, due to the presence of algebraic or logarithmic singularities.

During the course of this thesis, we have isolated any form of discussion about the rate of convergence of the formulas due to space and time. This thesis has also been silent on which of the formulas is faster. However, we mention in passing that Haber's formula A, which involves one single sum evaluation will be the fastest.

To sum up: one attribute of a good numerical scheme/formula is accuracy as the number of function evaluations increases. With that in mind, and as shown by the tables and figures in chapter 5, the Double Exponential sinc method proposed by Tanaka, Sugihara and Murota [32] is the most accurate for the numerical approximation of indefinite integrals of functions with or without singularities.

6.3 Recommendations for Further Study

A major pitfall of the quadrature formulas studied in this thesis is that the step size h used in the computation is a function of c and α , which are real numbers that depend on the behaviour of the integrand. It therefore will be interesting to consider finding another expression for h without necessarily depending on the behaviour of the integrand.

A further interesting study would be to look at how one would approximate the integrals in which the upper limit of integration is a polynomial or a transcendental function or a combination of these.

It is yet to be shown how the formulas studied in this thesis perform in comparison with the Clenshaw-Curtis quadrature scheme ([5], [7], [8], [12]).

An extension of the four quadrature formulas discussed in this thesis to the numerical approximation of singular multidimensional integrals is another topic for further study.

Appendix A

The Transformation $w = \tanh\left(\frac{z}{2}\right)$

We present a picture of the transformation $w = \tanh\left(\frac{z}{2}\right)$, with $z = x + iy$, $w = t + iv$. Let us call the shaded region $S = \{-\pi < \Im z < \pi\}$, $\Re z > 0$. We start

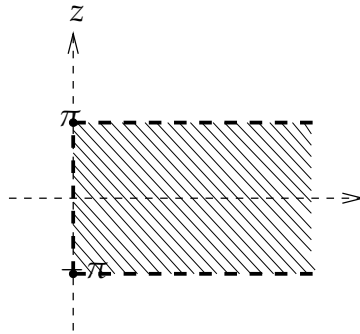

Figure A.1: Strip bounded by horizontal lines $y = -\pi$, $y = \pi$ and the y axis.

by considering the boundary line of S , $z = u - i\pi$, $0 \leq u < \infty$. This maps to $w = \infty$, since $w = \tanh\left(\frac{u - i\pi}{2}\right) = \frac{\tanh\left(\frac{u}{2}\right) - i \tan\left(\frac{\pi}{2}\right)}{1 - i \tanh\left(\frac{u}{2}\right) \tan\left(\frac{\pi}{2}\right)}$. In a similar fashion, $z = u + i\pi$ maps to $w = \infty$. The vertical line $x = 0$, $-\pi < y < \pi$, $u \in (-\infty, \infty)$ maps to $w = \tanh\left(\frac{i u}{2}\right) = i \tan\left(\frac{u}{2}\right)$, implying that $t = 0$ and $v = \tan\left(\frac{u}{2}\right)$. Since the horizontal lines $y = \pm\pi$ map to infinity, we have to consider the line $y = 0$, from which we obtain $w = \tanh\left(\frac{u}{2}\right)$, thus $t = \tanh\left(\frac{u}{2}\right)$ and $v = 0$.

Appendix B

Analytic Solutions

Here we present the analytic solutions to our test problems.

$$\int_{-1}^v \frac{1}{\pi\sqrt{1-x^2}} du = \frac{1}{\pi} \left(\sin^{-1}(v) + \frac{\pi}{2} \right). \quad (\text{B.1})$$

Using the technique of integration by parts, let $u = \log\left(\frac{1+x}{1-x}\right)$,
 $du = \frac{2}{(1-x)(x+1)}$ and $dv = dx$, hence $v = x$. Employing the technique of
partial fraction decomposition, $\frac{1}{(1-x)(x+1)} = \frac{1}{2(1-x)} + \frac{1}{2(x+1)}$. For $-1 <$
 $v < 1$,

$$\begin{aligned} \int \log\left(\frac{1+x}{1-x}\right) dx &= x \log\left(\frac{1+x}{1-x}\right) - 2 \int \frac{dx}{(1-x)(x+1)} \\ &= x \log\left(\frac{1+x}{1-x}\right) - \int \left[\frac{1}{1-x} + \frac{1}{x+1} \right] dx \\ \frac{1}{4 \log 2} \int_{-1}^v \log\left(\frac{1+x}{1-x}\right) dx &= \frac{1}{4 \log 2} \left[\left((x+1) \log(x+1) + (1-x) \log(1-x) \right) \Big|_{-1}^v \right] \\ &= \frac{1}{4 \log 2} \left[\log(1+v)^{(1+v)} + \log(1-v)^{(1-v)} - 2 \log 2 \right]. \end{aligned} \quad (\text{B.2})$$

Bibliography

- [1] M. J. Ablowitz and A. S. Fokas, *Complex variables: Introduction and applications*, second ed., Cambridge University Press, Cambridge, 1997.
- [2] M. Abramowitz and I. A. Stegun, *Handbook of mathematical functions*, Dover Publications, Inc., New York, U.S. Government Printing Office, Washington, DC, 1964.
- [3] R. O. Akinola, <http://math.sun.ac.za/~tokunbo/masters.html>, October 2006.
- [4] R. N. Bracewell, *The Fourier Transform and its Applications*, third ed., McGraw-Hill Series in Electrical and Computer Engineering, The McGraw-Hill Companies, Inc., Boston, Mass., 2000.
- [5] C. W. Clenshaw and A. R. Curtis, *A Method for Numerical Integration on an Automatic Computer*, *Numerische Mathematik* 2 (1960), 197–205.
- [6] P. J. Davis, *Interpolation and Approximation*, first ed., Blaisdell Publishing Company, Waltham, Mass., 1963.
- [7] H. Engels, *Numerical Quadrature and Cubature*, Computational Mathematics and Applications, Academic Press Inc., London, 1980.
- [8] S. Filippi, *Angenäherte Tschebyscheff-Approximation einer Stammfunktion-eine*

- Modifikation des Verfahrens von Clenshaw and Curtis*, Numerische Mathematik 6 (1964), 320–328.
- [9] W. B. Gearhart, and H. S. Shultz, *The Function $\frac{\sin x}{x}$* , The College Mathematics Journal 21 (1990), no. 2, 90–99.
- [10] S. Haber, *The Tanh Rule for Numerical Integration*, SIAM Journal of Numerical Analysis 14 (1977), no. 4, 668–685.
- [11] ———, *Two Formulas for Numerical Indefinite Integration*, Mathematics of Computation 60 (1993), no. 201, 279–296.
- [12] J. P. Imhof, *On the Method for Numerical Integration of Clenshaw and Curtis*, Numerische Mathematik 5 (1963), 138–141.
- [13] S. O. Iyehen, *Introduction to Complex Analysis*, first ed., Osaruwa Educational Publications, Benin City, 1998.
- [14] F. Ayres Jr, *Theory and Problems of Differential and Integral Calculus in SI Metric Units*, first and second ed., Schaum's Outline Series, Singapore, McGraw-Hill Book Company, 1981.
- [15] R. P. Boas Jr., *Entire Functions*, Academic Press, New York, 1954.
- [16] R. B. Kearfott, *A Sinc Approximation for the Indefinite Integral*, Mathematics of Computation 41 (1983), no. 164, 559–572.
- [17] E. Kreyszig, *Advanced Engineering Mathematics*, eighth ed., John Wiley & Sons, Inc., New York, 1999.
- [18] J. Lund and K. L. Bowers, *Sinc Methods for Quadrature and Differential Equations*, SIAM Philadelphia, 1992.

- [19] L. Lundin and F. Stenger, *Cardinal-Type Approximation of a Function and its Derivatives*, *SIAM Journal of Mathematical Analysis* **10** (1979), no. 1, 139–160.
- [20] J. McNamee, F. Stenger, and E. L. Whitney, *Whittaker's Cardinal Function in Retrospect*, *Mathematics of Computation* **25** (1971), no. 113, 141–154.
- [21] M. Muhammad and M. Mori, *Double Exponential Formulas for Numerical Indefinite Integration*, *Journal of Computational and Applied Mathematics* **161** (2003), 431–448.
- [22] A. Nurmuhhammad, M. Muhammad, and M. Mori, *Numerical Solution of Initial Value Problems Based on the Double Exponential Transformation*, *Publications of the Research Institute for Mathematical Sciences, Kyoto University* **41** (2005), 937–948.
- [23] M. R. Spiegel, *Schaum Outline Series of Complex Analysis*, Schaum Publishing Company, New York, July 1964.
- [24] F. Stenger, *An Analytic Function which is an Approximate Characteristic Function*, *SIAM Journal of Numerical Analysis* **12** (1975), no. 2, 239–254.
- [25] ———, *Approximations Via Whittaker's Cardinal Function*, *Journal of Approximation Theory* **17** (1976), 222–240.
- [26] ———, *Numerical Methods Based on Whittaker Cardinal or Sinc Functions*, *SIAM Review* **23** (1981), no. 2, 165–224.
- [27] ———, *Numerical Methods Based on Sinc and Analytic Functions*, Springer-Verlag, New York, 1993.
- [28] ———, *Summary of Sinc Numerical Methods*, *Journal of Computation and Applied Mathematics* **121** (2000), 379–420.

-
- [29] M. Sugihara, *Optimality of the Double Exponential Formula*, *Functional Analysis Approach*, *Numerische Mathematik* **75** (1997), 379–395.
- [30] ———, *Near Optimality of the Sinc Approximation*, *Mathematics of Computation* **72** (2002), no. 242, 767–786.
- [31] H. Takahasi and M. Mori, *Double Exponential Formulas for Numerical Integration*, *Publications of the Research Institute for Mathematical Sciences, Kyoto University* **4** (1974), no. 3, 721–741.
- [32] K. Tanaka, M. Sugihara, and K. Murota, *Numerical Indefinite Integration by Double Exponential Sinc Method*, *Mathematics of Computation* **74** (2004), no. 250, 655–679.
- [33] M. D. Weir, F. R. Giordano, and J. Hass, *Thomas' Calculus*, International eleventh ed., ch. 5, pp. 358–361, Pearson Addison Wesley, Boston, 2005.
- [34] E. W. Weisstein, *Sinc Function*, From MathWorld—A Wolfram Web Resource, <http://mathworld.wolfram.com/SincFunction.html>.

Index

- Si, 4
- si, 4
- sinc approximation, 3
- Mathematica[®] NDSolve, iii, 7, 132
- Matlab[®] ode45, iii, 7, 10, 132
- octave lode, 132
- octave, 7

- amplitude, 20
- analytic, 13, 37
- asymptotic, 5
- auxiliary angles, 20

- cardinal function, 32
- cardinal series, 33
- Cauchy Integral Theorem, 13
- Cauchy's Integral Formula, 13
- Cauchy's integral formula, 94
- Cauchy-Schwartz inequality, 18
- Cauchy-Schwartz inequality, 44
- Clenshaw-Curtis, 134
- concentric, 14
- conformal map, 69
- conformal Mapping, 17
- conformal mapping, 52
- connected, 12
- contour, 13
- contour integral, 37
- convergence, 133

- differentiable, 12, 131
- discontinuity, 24
- disk, 12
- Double Exponential, 68

- entire, 13
- entire function, 31
- essential singularity, 15
- Euler's formulas, 20
- exponential type, 31
- extended complex plane, 12

- fan-shaped, 89
- finite plane, 13
- Fourier Analysis, 19
- Fourier coefficients, 20, 21
- Fourier cosine, 25
- Fourier integral, 24
- Fourier series, 36

- Fourier transform, 27
- Fourier transforms, 23
- Function Spaces, 82
- functional analysis, 17
- Fundamental Theorem of Calculus, 131
- Hölder's Inequality, 18
- Haber's formula A, 32, 58
- Haber's formula B, 65
- Hilbert space, 19
- indefinite integration, 71
- infinite series, 32
- infinite strip, 39
- inner product space, 18
- integrable, 17
- interpolation, 33
- inverse Fourier transform, 27
- Kronecker delta, 30
- Laurent's Theorem, 14
- Lebesgue measurable, 59
- Maclaurin series, 4
- measurable, 17
- meta-optimality, 82
- Minkowski's inequality, 18
- Morera's Theorem, 13
- Mori, 68
- neighbourhood, 12
- non-vanishing, 82
- norm, 17, 19
- normalise, 67
- normed linear space, 17
- numerical indefinite integration, 23, 104
- numerical integration, 28
- open set, 12
- orthonormal, 19
- orthonormal set, 30
- Paley-Wiener, 31, 32, 37
- Paley-Wiener Theorem, 35
- Parseval's Theorem, 29, 30
- periodic, 19
- Phragmén-Lindelöf, 89
- quadrature formula, 35
- quadrature formulas, 111
- rectangular contour, 37
- removable singularity, 15, 16
- residue, 16
- Residue Theorem, 38
- residues, 15
- SE formula, 81
- Seymour Haber, 7
- sinc function, 23

-
- sinc interpolation, 71
 - sinc method, 7
 - sine cardinal, 3
 - sine integral, 3, 51
 - sine transforms, 25
 - Single Exponential, 68
 - Single Exponential Formula, 117
 - singularities, 37, 58
 - singularity, 14
 - Sugihara, 82
 - symmetric, 99

 - Takahasi, 68
 - Tanaka et al's, 106
 - Tanaka et al's formula, 81, 127
 - triangle inequality, 18
 - trigonometric series, 20
 - truncated cardinal series, 33

 - upper half-plane, 12