

# **System Dynamics Simulation of Income Distribution and Electric Vehicle Diffusion for Electricity Planning in South Africa**

By

Nalini Sooknanan Pillay

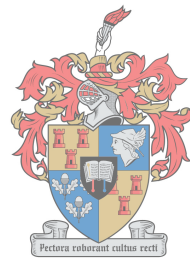

UNIVERSITEIT  
iYUNIVESITHI  
STELLENBOSCH

*Dissertation presented for the degree of Doctor of Philosophy in the Department of  
Industrial Engineering at Stellenbosch University*



1918-2018

**Supervisor:** Prof AC Brent

**Co-supervisor:** Prof JK Musango

**Co-supervisor:** Prof SS Grobbelaar

December 2018

## **Declaration**

By submitting this dissertation electronically, I declare that the entirety of the work contained therein is my own, original work, that I am the sole author thereof (save to the extent explicitly otherwise stated); that reproduction and publication thereof by Stellenbosch University will not infringe any third party rights; and that I have not previously, in its entirety or in part, submitted it for obtaining any qualification.

Date: December 2018

## Abstract

The electricity generation industry has developed a symbiotic interdependence with the social, environmental, economic and political ecologies in the country, resulting in divergent complexities, which require non-linear model-based planning methodologies. Some of the determinants influencing the power industry include technologies, such as battery electric vehicles (BEVs), which have gained prominence as a possible option to support South Africa's climate change commitments. This study used an adapted system dynamics modelling process to determine the provincial affordability of BEVs in South Africa so that amended regional forecasts of BEVs could be established to plan for charging infrastructure, environmental impacts in the energy and transport sectors, as well as changes in electricity consumption. Results from the Electricity Strategic Battery Electric Vehicle (E-StratBEV) simulator indicate that aligning BEV market penetration with the current consumer behaviour within deciles on vehicle expenditure, results in significantly lower than the expected market penetration. This means that by 2040, a low growth GDP-based target of 233,700 BEVs could adjust to 44,155 BEVs, while a high growth scenario of 2,389,950 BEVs (based on South Africa's commitment in the Paris Agreement) could adjust to 451,736 BEVs. The inclusion of BEV drivers, such as reduced purchase price, increased charging infrastructure, reduced "range anxiety", and improved reputation effect, add a further cumulative total of 270 GWh from 2019 until 2040 for the low growth scenario, and an additional 2,764 GWh for the high growth scenario, to the residential electricity consumption. From 2019 to 2040, a renewables heavy supply mix results in a 7% cumulative decrease in CO<sub>2</sub> emissions in the transport sector; however, with a coal heavy supply mix, no gains in carbon emission reduction is achieved. The adapted system dynamics modelling process allowed for the successful development and implementation of the E-StratBEV, however, the process can be further enhanced by establishing preliminary complexity criteria to ensure a project requires this method before commencement.

## **Acknowledgements**

This thesis is a culmination of several years of extensive learning, frustrations, introspection and persistence, but ultimately, it has been a truly inspiring and fulfilling experience.

I am greatly indebted to my supervisor Professor Alan Brent, who believed in my ability to deliver on an “ambitious” study, and for his continuous support, patience and technical guidance throughout this journey. Sincerest gratitude also goes to my other supervisor, Professor Josephine Musango, for her enthusiasm, immense knowledge and motivation at times when I felt overwhelmed and could easily have surrendered the ultimate challenge of completing my PhD.

Thanks to Eskom SOC for funding my studies and providing opportunities for learning and technical engagement. Thanks to the team in the Eskom System Dynamics Centre of Expertise for trusting and believing in my leadership so that we could collectively advance system dynamics modelling and skills in South Africa – efforts which resulted in the adapted process. Specific thanks to Danie Booyens for his continuous support, insightful comments and for being my technical sanity check, throughout the study.

I am also grateful for the friends and family in my life that provided moral support and helped me in getting through a very emotional and life changing couple years of my life.

## **Dedication**

This thesis is dedicated to my three children: Tejal, Anita and Nikhil. I am abundantly blessed to have received your unflinching love, encouragement and tolerance for the countless days I spent away from you while working on my studies. You made me stronger, better and more fulfilled than I have ever been. Your conviction in me kept me grounded while I tried to balance my parenting duties with work and studies, in between life's vacillations. I could not have made it to the end without you. My message to you is that you can achieve your dreams with passion, hard work and commitment but whatever you do - remember that life is too short to be anything other than happy. No matter how hard life gets at times, always look for that silver lining, because there will always be something to be grateful for.

## Table of Contents

### Chapter 1

1.1 Background .....	18
1.2 Problem Description .....	19
1.3 Research Objectives .....	20
1.4 Justification and Scope of the Research .....	21
1.5 Original Research Contribution .....	21
1.6 Research Design .....	22
1.7 Thesis Structure .....	24

### Chapter 2

2.1 Theoretical Considerations .....	26
2.2 Approach to the Literature Analysis .....	26
2.3 The Energy Sector .....	27
2.3.1 Electricity Supply and Electricity Consumption in SA .....	27
2.3.2 Transport Sector in South Africa .....	29
2.3.2.1 <i>Factors Influencing the Demand for Passenger ICEVs</i> .....	29
2.4 Electric Vehicles .....	31
2.4.1 Brief History of Electric Vehicles including Commercialisation .....	31
2.4.2 Types of Electric Vehicles .....	36
2.4.3 Batteries for Electric Vehicles .....	37
2.4.5 Factors affecting EV Adoption .....	42
2.4.5.1 <i>Subsidies and Other Incentives</i> .....	42
2.4.5.2 <i>Import Taxes</i> .....	43
2.4.5.4 <i>Charging Infrastructure</i> .....	45
2.4.5.5 <i>Consumer Perception and Consumer Behaviour</i> .....	45
2.4.6.1 <i>Department of Transport: Green Transport Strategy and the Roads Policy</i> .....	49
2.4.6.2 <i>UNIDO's Low Carbon Transport South Africa Project (LCT SA)</i> .....	49
2.4.6.3 <i>SANEDI's Cleaner Mobility Programme</i> .....	49
2.4.6.4 <i>The CSIR Energy Fleet</i> .....	49
2.4.6.5 <i>uYilo eMobility Programme</i> .....	50
2.4.6.6 <i>Transport Nationally Appropriate Mitigation Actions (NAMA) project</i> .....	50
2.4.6.7 <i>eBike Sharing Schemes (NMMU)</i> .....	51
2.4.6.8 <i>EV Charging infrastructure roll outs</i> .....	51
2.4.6.9 <i>EV Public transport developments</i> .....	52
2.4.6.10 <i>Eskom eMobility Programme</i> .....	53
2.4.7 Technology Roadmaps for EVs .....	53
2.4.8 BEV Forecasts in South Africa .....	57
2.4.9 Environmental Aspects including Carbon Emissions .....	60
2.5 South Africa's Provinces .....	61

2.5.1 GDP and Population .....	62
2.5.2 Income Inequality .....	64
2.5.3 Provincial Distribution of Vehicles .....	67
2.6 Modelling Methods for Electric Vehicle Studies .....	70
2.6.1 Requirements of the Method.....	70
2.6.2 Modelling Methods .....	71
2.6.2.1 <i>System Dynamics Modelling</i> .....	73
2.6.2.2 <i>Modelling Software for the System Dynamics Modelling Process</i> .....	75
2.7 Summary .....	76

### Chapter 3

3.1 Overview .....	78
3.2 Method Selection.....	78
3.2.1 Requirements of the Method.....	78
3.2.2 Background and history of method: System Dynamics .....	79
3.2.3 Overview of the System Dynamics Modelling Process.....	80
3.3 Adapted System Dynamics Modelling Process .....	83
3.3.1 Identification of the Appropriate Customer/ Custodian .....	84
3.3.2 Conceptualisation to Contextualisation with a Theoretical Framework .....	85
3.3.3 Collaborative Brainstorming and Boundary Setting .....	87
3.3.4 System Analysis .....	90
3.3.4.1 <i>Electricity Load</i> .....	91
3.3.4.2 <i>BEV Data Analysis</i> .....	93
3.3.4.2.1 <i>Fast Charging</i> .....	94
3.3.4.2.2 <i>Mobility Profile</i> .....	95
3.3.4.2.3 <i>BEV Charging and Consumption Profiles</i> .....	96
3.3.4.2.4 <i>BEV Distance</i> .....	96
3.3.5 Model Development and Design .....	98
3.3.6 Validation and Policy Insights .....	100
3.3.7 Final Model Handover .....	100
3.4 Summary .....	100

### Chapter 4

4.1 Overview .....	102
4.2 Defining the System Boundary for STEVsim .....	102
4.3 Model Structures .....	103
4.3.1 STEVsim Electricity Generation Capacity Module .....	103
4.3.2 STEVsim Electricity Demand Module .....	104
4.3.3 STEVsim Emissions Module .....	105
4.4 Interface Design & Development .....	106
4.5 Scenarios .....	107

4.6 STEVsim Results .....	108
4.6 Summary .....	110

## Chapter 5

5.1 Overview .....	112
5.2 Context for the E-StratBEV .....	112
5.3 Module Development for the E-StratBEV .....	114
5.3.1 Electricity Generation Capacity Module .....	114
5.3.2 Economy Module.....	120
5.3.2.1 GDP Sub-module .....	120
5.3.2.2 Electricity Consumption Sub-module .....	122
5.3.3 Income Module.....	127
5.3.3.1 Household Sub-module.....	127
5.3.3.2 Real Disposable Income .....	128
5.3.4 ICEV Sub-module .....	129
5.3.4.1 Actual ICEVs .....	129
5.3.4.2 Actual ICEVs with Scrappage Sub-module.....	130
5.3.4.3 ICEV Carbon Emissions and Fuel Efficiency Sub-module .....	133
5.3.4.4 Affordable ICEVs Sub-module .....	135
5.3.4.4 ICEV Correction Factor .....	138
5.3.5 BEVs Module.....	138
5.3.5.1 BEV Provincial Distributions.....	139
5.3.5.2 BEV Adjustment Factor.....	140
5.3.5.3 BEV Drivers.....	140
5.3.5.4 BEV Charging Requirements .....	145
5.4 E-StratBEV validation.....	145
5.5 E-StratBEV Engagement Platforms .....	146
5.6 Summary .....	150

## Chapter 6

6.1 Overview .....	151
6.2 BEV Scenario Definitions .....	151
6.3 The South African Economy .....	153.
6.3.1 GDP .....	153
6.3.2 GDP and Gini Coefficient Impact on Residential Consumption.....	155
6.3.3 Disposable Income.....	156
6.5 BEV Distributions Based on GDP, Disposable Income and ICEVs Fractions .....	163
6.6 Impact of Electric Vehicle Market Penetration on Residential Electricity Consumption .....	165
6.6.1 BEV Impact on Reserve Margin with Changing Generation Supply Mix .....	167
6.7 Key Drivers Impacting BEV Market Penetration .....	171
6.8 Environmental Impacts of BEVs.....	172



6.9 BEV Distributions Based on Vehicle Expenditure within Deciles.....	177
6.10 Summary .....	181

**Chapter 7**

7.1 Overview .....	184
7.2 Summary of Findings .....	184
7.2.1 System Dynamics Modelling Process.....	184
7.2.2 Scenario and Sensitivity Analysis .....	185
7.3 Validation of Contributions .....	187
7.4 Limitations of the Study .....	189
7.5 Opportunities for Future Research.....	190

<b>References</b> .....	192
-------------------------	-----

**Appendices**

Appendix A .....	223
Appendix B .....	227
Appendix C .....	229

## List of Abbreviations

AMPS	All Media and Product Survey
B	Balancing loop
BEV	Battery Electric Vehicle
CLD	Causal Loop Diagram
EV	Electric Vehicle
FCE	Final Consumption Expenditure
GC	Gini Coefficient
GDP	Gross Domestic Product
GWh	Gigawatt hour
HEV	Hybrid Electric Vehicle
HH	Households
ICE	Internal Combustion Engine
IPPs	Independent Power Producers
MBC	Model Boundary Chart
MIDP	Motor Industry Development Program
MWh	Megawatt hour
PHEV	Plug-in Hybrid Electric Vehicle
PV	Photovoltaic
R	Reinforcing loop
SA	South Africa
SAIRR	South African Institute of Race Relations
SAM	System Architecture Map
SOC	State Owned Company
TFCE	Total Final Consumption Expenditure
VAT	Value Added Tax

## List of Figures

- Figure 1.1.: Diagrammatic Layout of the Thesis
- Figure 2.1 Sales of Passenger Motor Vehicles in South Africa
- Figure 2.2 First Electric Vehicle – Thomas Parker
- Figure 2.3 Game Viewing Electric Bus
- Figure 2.4 Shuttle Bus for Robben Island
- Figure 2.5 Nissan Leaf EV in the Collaborative Eskom Pilot
- Figure 2.6: EV Battery Pack Manufacturing Costs
- Figure 2.7: IEA EV Battery Pack Costs
- Figure 2.8: Electric Vehicle for Safari Mobility
- Figure 2.9: eBikes, NMMU
- Figure 2.10: Solar-powered Electric Car Charger – City of Cape Town
- Figure 2.11: Mine haulage testing of Futran
- Figure 2.12: Gartner Hype Cycle with an EV Forecast
- Figure 2.13: Emissions for Electric Vehicles (Grams CO<sub>2</sub>e/km)
- Figure 2.14: Map of the South African Provinces
- Figure 2.15: GDP per Capita for South Africa and the Provinces
- Figure 3.1: System Dynamics Modelling Process
- Figure 3.2: Illustrative Stock Flow Diagram
- Figure 3.3: Adapted System Dynamics Modelling Process
- Figure 3.4: System Architecture Map
- Figure 3.5: Causal Loop Diagram of Factors Affecting BEVs
- Figure 3.6: Causal Loop Diagram of BEV Drivers
- Figure 3.7: Average hourly demand per month in 2015
- Figure 3.8: Daily Electricity Load Profiles – June 2015
- Figure 3.9: Fast Charging as a Percent of Overall Charging
- Figure 3.10: Vehicle Usage Profiles
- Figure 3.11: Daily Average Consumption and Charging profiles – July 2015
- Figure 3.12: Vehicle Usage Percent (Weekday Vs Weekend)
- Figure 4.1: Average Monthly Number of New Passenger Vehicles Annually
- Figure 4.2: Model Structure – Daily Electricity Demand
- Figure 4.3: Model Structure – Carbon Emissions from ICEVs
- Figure 4.4: Model Interface – STEVsim: Energy Demand Dynamics
- Figure 4.5: Model Interface – STEVsim: Environmental Dynamics
- Figure 4.6: Daily Electricity Consumption Profiles
- Figure 4.7: Additional Electricity Required for BEV Charging
- Figure 4.8: Comparison of Carbon Emissions in the Transport and Energy Sectors
- Figure 5.1: Supply Mix of Existing Generation Capacity
- Figure 5.2: Current Eskom Electricity Supply (Base-load Capacity)
- Figure 5.3: Eskom Base-load Future Supply Mix
- Figure 5.4: Eskom Peaking Future Supply Mix

- Figure 5.5: Coal Heavy Future Supply Mix (Base-load and Peaking)
- Figure 5.6: Renewables Heavy Future Supply Mix (Base-load and Peaking)
- Figure 5.7: GDP Sub-module
- Figure 5.8: Provincial Contributions to GDP
- Figure 5.9: GDP linked to Residential Electricity Consumption and the Gini Coefficient
- Figure 5.10: Provincial Contributions to the National Population
- Figure 5.11: Provincial Residential Electricity Consumption
- Figure 5.12: Provincial Sectoral Electricity Consumption
- Figure 5.13: Household Growth
- Figure 5.14: Provincial Household Growth
- Figure 5.15: Historical Household Data per Province
- Figure 5.16: Real Disposable Income
- Figure 5.17: Historical ICEV Data per Province
- Figure 5.18: ICEV structure with Scrappage
- Figure 5.19: Split of Provincial Annual Passenger Vehicle Distance travelled (2009)
- Figure 5.20: S-curve of ICEV Fuel Efficiency Improvements Over Time
- Figure 5.21: Fuel Economy and ICEV Carbon Emissions Calculations
- Figure 5.22: Model Structure to Calculate Affordable ICEVs
- Figure 5.23: ICEV Correction factors for Provinces
- Figure 5.24: BEV Target Inputs
- Figure 5.25: Provincial Allocation of BEVs
- Figure 5.26: Range Anxiety Impact on BEV Penetration
- Figure 5.27: Reputation Effect Impact on BEV Penetration
- Figure 5.28: Lithium-ion Battery Cost over Time
- Figure 5.29: Penetration of BEVs Influenced by Purchase Price
- Figure 5.30: Purchase Price Impact on BEV Penetration
- Figure 5.31: Change in BEV to Charging Station Ratio Impact on BEV Penetration
- Figure 5.32: Supply Side Engagement Platform
- Figure 5.33: Gini coefficient and GDP Engagement Platform
- Figure 5.34: BEV Target Setting
- Figure 5.35: Disposable Income Engagement Platform
- Figure 5.36: ICEV Engagement Platform
- Figure 5.37: BEV Drivers Engagement Platform
- Figure 6.1: Average GDP per Province per Period 1993-2018 and 2019-2050
- Figure 6.2: Impact of GDP and Gini coefficient on Residential Electricity Consumption (TWh)
- Figure 6.3: Real Disposable Incomes on a Provincial Level
- Figure 6.4: Real Disposable Incomes on a National Decile Level
- Figure 6.5: Provincial Distribution of Actual ICEVs (No BEVs)
- Figure 6.6: Actual and Affordable ICEVs from 1993-2050
- Figure 6.7: Provincial Average Differences between Actual and Affordable ICEVs
- Figure 6.8: National Number of Actual & Affordable ICE Motor Vehicles (Deciles 1, 5 & 10)

- Figure 6.9: Low Growth and High Growth BEV Distributions per Province in 2040
- Figure 6.10: Impact of BEV Targets on Residential Consumption from 2019 until 2040
- Figure 6.11: Cumulative Provincial Residential Electricity Consumption from 2019 until 2040
- Figure 6.12: Low Growth Scenario: BEV Electricity Consumption in 2019, 2030 and 2040
- Figure 6.13: High Growth Scenario: BEV Electricity Consumption in 2019, 2030 and 2040
- Figure 6.14: BEV Distributions according to BEV Driver Influences (2019-2040)
- Figure 6.15: Low Growth Provincial Cumulative Carbon Emissions from 2019 until 2040
- Figure 6.16: High Growth Provincial Cumulative Carbon Emissions from 2019 until 2040
- Figure 6.17: BEV Low Growth and Low Growth Adjusted in 2040
- Figure 6.18: BEV High Growth and High Growth Adjusted in 2040
- Figure 6.19: Decile 10 - Low and High Growth BEV Adjusted to Expenditure Deciles (2040)
- Figure 6.20: Decile 9 - Low and High Growth BEV Adjusted to Expenditure Deciles (2040)
- Figure 6.21: Decile 8 - Low and High Growth BEV Adjusted to Expenditure Deciles (2040)
- Figure 6.22: Decile 7 - Low and High Growth BEV Adjusted to Expenditure Deciles (2040)
- Figure 6.23: Decile 6 - Low and High Growth BEV Adjusted to Expenditure Deciles (2040)
- Figure 6.24: Deciles 4 & 5 - Low and High Growth BEV Adjusted to Expenditure Deciles (2040)

## List of Tables

Table 2.1	Comparisons of Various EV Makes
Table 2.2	Comparison between a Combustion Engine and an Electric Vehicle
Table 2.3	Factors affecting Electric Vehicle Adoption
Table 2.4	Factors Affecting Overall EV Value
Table 2.5	Risk barriers to EV Adoption
Table 2.6	Consumer Valuation of Buying Incentives
Table 2.7	Possible Localisation of EV Components
Table 2.8:	PH/BEV numbers and targets with required annual growth rates
Table 2.9	GDP and Population per Province
Table 2.10	Gini Coefficient per Province
Table 2.11:	Monthly Income and Proportion of Households with ICEVs
Table 2.12:	Households with a Motor Vehicle per Province
Table 2.13:	Expenditure on Transport and Vehicle Purchases per decile
Table 2.14:	Percent of Motor Cars at Various Ages per Province
Table 2.15:	Average Age of Motor Vehicles per Province
Table 2.16:	BEV numbers and Energy Demand per Province by 2030 (Low Adoption)
Table 2.17:	BEV numbers and Energy Demand per Province by 2030 (Medium Adoption)
Table 2.18:	BEV numbers and Electrical Energy Demand per Province by 2030 (High Adoption)
Table 2.19:	Summary of System Dynamics Modelling Software
Table 3.1:	Components of System Dynamics Modelling
Table 3.2:	Model Boundary Chart
Table 3.3:	Electricity Load Hourly Data
Table 3.4:	BEV Raw Data
Table 3.5:	Daily Average BEV Distances for July 2015
Table 3.6:	Interface Tools to Engage with the iSee STELLA Model
Table 4.1:	STEVsim Scenarios for BEV Monthly Market Penetration
Table 5.1:	Modules and Sub-modules in E-StratBEV
Table 5.2:	Economic Sector GDP Splits (2016)
Table 5.3:	Provincial Share of Households (2016)
Table 5.5:	Regression Equations for Provincial ICEVs (where x is time)
Table 5.4:	Average Household Income per Province
Table 5.6:	Percent Scrapage Rate by Age for Passenger Vehicles
Table 5.7:	Average Age of Motor Cars per Province
Table 5.8:	Passenger Fuel Economy and Emission Factors
Table 5.9:	Monthly Income and Proportion of Households with ICEVs
Table 5.10:	Expenditure on Transport and Vehicle Purchases per decile
Table 5.11:	Provincial Rankings for GDP, Population, ICEVs and Disposable Income (2016)
Table 5.12:	Weight Fractions of Factors affecting BEV Penetration
Table 6.1:	Annual BEV Sales Required for BEV Scenarios
Table 6.2:	Average Number of Actual ICEVs per Period per Province

Table 6.3: Average ICEVs per 1000 people (2016, 2030 and 2040)

Table 6.4: BEVs per province in 2040 for Various Parameter Fractions

Table 6.5: Impact of BEV Targets on Residential Electricity Consumption

Table 6.6: National Residential Electricity Consumption (TWh)

Table 6.7: BEV Market Penetration with Drivers

Table 6.8: National Cumulative Change in Carbon Emissions (Mton)

## Definitions Related to the Study

An **electric vehicle** is “a vehicle which uses one or more electric motors for propulsion. Depending on the type of vehicle, motion may be provided by wheels or propellers driven by rotary motors, or in the case of tracked vehicles, by linear motors.” (ElectricVehicleNews, 2010). According to 15 United States Code 2502 (United States Government Publishing Office, 2011), an electric vehicle is defined as: “A vehicle which is powered by an electric motor drawing current from rechargeable storage batteries, fuel cells or other portable sources of electrical current, and which may include a non-electrical source of power designed to charge batteries and components thereof”.

An **internal combustion engine** vehicle is where an engine of one or more working cylinders undergoes a combustion process through burning fuel (Guzzella & Onder, 2010).

**Electrical power** is expressed in megawatts (MW) and reflects the output from the power stations while the *energy consumed* from electricity generation is measured megawatt-hours (MWh). The total residential electricity consumption in MWh was summed over the simulation timeframe (1993-2050).

**Range Anxiety** is a driver worrying that battery of the electric vehicle will run out of power before they arrive at their destination (Bonges III & Lusk, 2016).

**Final Consumption Expenditure** is expenditure by households linked to good and services used to satisfy wants and needs including durable products such as cars, washing machines and home computers (Index Mundi).

**Disposable income** is when an individual's income after personal income tax has been deducted, and includes labour remuneration, income from property, government transfers and incorporated business enterprise transfers (Collins, 2018).

**Income deciles** show the average income for different income groupings in society (a decile splits the households into 10 equal parts with decile 1 representing the lowest income and decile 10 the highest income (Pettinger, 2015).



## List of Publications from the Study

Pillay N.S., Brent A.C., Musango J.K. (2017, October). *Using System Dynamics (SD) to Model the Impact of Electric Vehicles on the Electricity Demand Profiles*, 14<sup>th</sup> INCOSE SA Conference 2018, Pretoria, South Africa.

Pillay N.S., Brent A.C. Musango J.K. (2017, November). *Is There a Lesser Evil? Carbon Emissions from Internal Combustion Engines and Coal Fired Power Stations in South Africa*, 5<sup>th</sup> Annual South African System Dynamics Conference, Johannesburg, South Africa.

Pillay N.S., Brent A.C., Musango J.K. (2018, August). *Drivers Impacting BEV Production Cost and Monthly Repayments*, 36<sup>th</sup> International Conference of the System Dynamics Society, Reykjavik, Iceland.

Pillay N.S., Brent A.C., Musango J.K., 2018, *Affordability of Battery Electric Vehicles based on Disposable Income and the Impact on Provincial Residential Electricity Requirements in South Africa*, Energy, in review.

Pillay N.S., Brent A.C., Musango J.K., Van Geems F., Tayob K. (2018, September). *Planning for eMobility in an Electricity Utility*, Research Conference 2018, Eskom Academy of Learning, Johannesburg, South Africa.

Pillay N.S., Brent A.C., Musango J.K. (2018, October). *An Adapted System Dynamics Approach to Determine the Linkage between Battery Electric Vehicle Affordability and Real Disposable Income in South Africa*, 29<sup>th</sup> Annual Conference of the SAIEE, Stellenbosch, South Africa.

Pillay N.S., Brent A.C., Musango J.K. (2018, November). *Economic Parameter Sensitivity on Provincial Electric Vehicle Distribution in South Africa*, 6<sup>th</sup> Annual South African System Dynamics Conference, University of Witwatersrand, Johannesburg, South Africa.

Pillay N.S., Brent A.C., Musango J.K. (2018, November). *Control Theory and System Dynamics in Simulating Battery Electric Vehicle Market Penetration In South Africa*, The 2<sup>nd</sup> International Conference on Emerging Trends in Electrical, Electronic and Communications Engineering (ELECOM2018), University of Mauritius, Mauritius.

# Chapter 1: Introduction

---

## 1.1 Background

Globally, the impact of social, environmental, economic and political changes on energy planning (Brouwer, et al., 2018; Baker & Phillips, 2018) has resulted in integrated approaches (Biloslavo, Bagnoli, & Edgar, 2018; Mirjat, Uqaili, Harijan, Mustafa, Rahman, & Khan, 2018) to address the inherent and somewhat divergent complexities in the volatile electricity planning space (Olsina, Garces, & Haubrich, 2006). These complexities require an evolving business model with a dynamic planning approach (Ervural, Evren, & Delen, 2018) capable of understanding feedback behaviour across the electricity value chain (Krishnan, et al., 2016), resonant with many power utilities.

The business models that power utilities adopt are influenced by technologies impacting the generation supply mix (Awerbuch, 2006), electricity demand side (Darby, 2018), as well as disruptive technologies<sup>1</sup> (Bergek, Berggren, Magnusson, & Hobday, 2013), such as electric vehicles (EVs) (Nieuwenhuis, 2018), which may require model-based planning methodologies (Dyner & Larsen, 2001; Foley, O Gallachoir, Hur, Baldick, & McKeogh, 2010).

Electric vehicles have been supported in South Africa's Green Transport Strategy (DOT, 2016) to reduce carbon emissions in the transportation sector, as part of climate change mitigation measures (Doucette & McCulloch, 2011). Passenger vehicles are projected to increase to 2.9 billion by 2050 globally (Chamon, Mauro, & Okawa, 2008), while vehicle growth trends in South Africa indicate a doubling of CO<sub>2</sub> emissions by 2050 in the transport industry (Merven, Stone, Hughes, & Cohen, 2012). Although EVs do not produce tailpipe CO<sub>2</sub> emissions, and may assist in reducing carbon emissions in the transport sector, they require electrical energy for charging their batteries, which would have to be supplied from electricity generation processes (Doucette & McCulloch, 2011). It is thus important for power utilities, such as Eskom, a State Owned Company (SOC), to determine the impact of various market penetration rates of electric vehicles on the electricity demand profile (Langley, 2015), and on carbon emissions, due to the fossil heavy generation mix (Eskom, 2010).

---

<sup>1</sup> A disruptive technology is defined as “a technology that changes the bases of competition by changing the performance metrics along which firms compete” (Danneels, 2004)

The rate of uptake of electric vehicles is influenced by many factors, including: battery range (Duke, Andrews, & Anderson, 2009), charging infrastructure (Coffman, Bernstein, & Wee, 2016), retail price (Egbue & Long, 2012), fuel cost saving (Hidruue, Parsons, Kempton, & Gardner, 2011), and consumer subsidies and incentives (Element Energy Limited, 2013; Sierzchula, Bakker, Maat, & Van Wee, 2014). In addition to these factors, Zubaryeva et al. (2012) suggest that demographic criteria, linking income to EV adoption, are also critical in understanding the extent of EV market penetration in households.

No peer-reviewed publications were identified with forecasts of the BEV market penetration values for South Africa linked to affordability; which is expected to influence the rate of BEV uptake, in addition to various drivers.

## **1.2 Problem Description**

Since 2012, a plethora of events, initiatives, and rollouts to support the introduction of EV technology emerged in South Africa, including: the EV industry roadmap for South Africa in 2013, alongside the launch of the green fleet by the Department of Environmental Affairs (Suleman, Gaylard, Tshaka, & Snyman, 2015); the formation of the Electric Vehicle Infrastructure Alliance (EVIA) with the purpose of developing EV infrastructure hardware and software standards, including the rollout of charging stations at appropriate locations; and an Eskom-Nissan battery electric vehicle (BEV) program to pilot ten passenger sedans in 2013 (Langley, 2016). With these initiatives to support the substitution of the internal combustion engine vehicle (ICEV) with EVs and reduce carbon emissions in the transportation sector (DOT, 2016), BEV market penetration forecasts emerged; for example, the Government's Green Transport Strategy plans for 2.9 million electric vehicles by 2050 (DOT, 2016).

The forecasts and rate of uptake of electric vehicles are influenced by many factors, including: battery life, supporting infrastructures, regulatory frameworks, financial incentives, consumer perceptions, public policies and strategies, as well as creative business models to market EVs (Element Energy Limited, 2013; Haddadian, Khodayar, & Shahidehpour, 2015). Consumer perception has also been identified as a potential barrier to increased EV adoption; for example, the consumer's ability and knowledge to calculate and compare the financial benefits of EVs and ICEVs, consumer perceptions with respect to the environment, fuels and vehicles, social norms, and emotive and psychological triggers (Rezvani, Jansson, & Bodin, 2015).

Income elasticity studies of vehicle ownership indicate a linkage and dependence on per capita income, with vehicle ownership growing twice as fast as income for low to middle income households and reaching saturation for the highest income levels (Dargaya & Gatelyb, 1999). In South Africa, the various average disposable income per capita will have to be linked to vehicle affordability to assess the potential of the residential consumer in South Africa to purchase motor vehicles; specifically BEVs in favour of ICEVs. This study focuses on income distribution dynamics, to be used as a proxy for vehicle affordability calculations, so that regional forecasts of BEVs can be determined to plan for charging infrastructure, environmental impacts and electricity demand.

This study used a system dynamics methodology (Forrester, 2009) to determine the provincial and national affordability of battery electric vehicles (using average disposable income profiles), in South Africa. The nine Constitutional provinces of South Africa included in this study were: Mpumalanga; Limpopo; Gauteng; North West; Northern Cape; Free State; KwaZulu Natal; Eastern Cape; and Western Cape. The number of internal combustion engine vehicles (ICEVs) was determined and then substituted with BEV targets, after which the impact on electricity consumption and CO<sub>2</sub> emissions (in the transport and electricity sectors) was calculated.

### **1.3 Research Objectives**

The research objectives of this study were to:

- a) Understand the short-term impact of the BEV daily charging requirements on the daily electricity demand load profile.
- b) Determine the BEV targets and scenarios possible for South Africa in the long-term (2019-2040). Understand the sensitivity of provincial BEV distributions as a function of possible parameters (Gross Domestic Profit, disposable income and ICEV fractions) and then determine the most suitable parameter. The correct parameterisation is important since it would affect the electricity consumption and carbon emissions calculations on a provincial level.
- c) Establish the ICEV forecast based on historical empirical data, as well as the affordable ICEVs based on disposable income, provincially, so that substitution with BEVs could be made from 2019 until 2040.
- d) Examine the impact of BEV market penetration on residential electricity consumption.

- e) Determine the number of additional BEVs based on drivers such as purchase price, charging infrastructure, range anxiety and reputation effect.
- f) Calculate the environmental impact of BEV substitution with ICEVs both in the transport and energy sectors, factoring in a changing electricity supply mix (a coal heavy supply mix compared to a renewables heavy supply mix).
- g) Establish the adjusted number of provincial BEV distributions based on consumer affordability and vehicle expenditure behaviour in the various income deciles.
- h) Develop a mathematically sound, system representative simulation tool using an adapted system dynamics modelling process to allow for scenario and sensitivity analyses.

#### **1.4 Justification and Scope of the Research**

It is sensible to understand the drivers, which may result in increased substitution of ICEVs with BEVs and to calculate the environmental impact and implications for electricity planning. However, if consumers do not have the disposable income to purchase these BEVs, it will affect the accuracy of the BEV market penetration forecasts in South Africa. Depending on the economic growth profiles in the provinces, as well as the disposable income of these residential sectors, passenger motor vehicle ownership volumes are different (Van Heerden, 2016). The substitution of the ICE vehicles with BEVs would mean greater electricity demand, and hence consumption, of electricity (Foley, Tyther, Calnan, & Ó Gallachóirab, 2013), and by understanding which province is most likely to require more electrical energy to charge the BEVs, it may be possible to plan charging infrastructure and ensure adequate electricity supply to the municipalities supplying these sectors (Brouwer, Kuramochi, Van Den Broek, & Faaij, 2013). The research study thus looks at the electricity supply mix and demand profiles with and without various BEV targets, affected by various driving factors and affordability.

#### **1.5 Original Research Contribution**

A literature review of the linkage between the disposable income and the provincial distribution of ICEVs in South Africa, indicated a shortfall in peer reviewed publications, although data on registered vehicles was available (NAAMSA, 2017) together with reports on transport strategies and programs (DTI, 2012), as well as reports on transport energy demand (Merven, Stone, Hughes, & Cohen, 2012). Thus, the time series trends showing the provincial distribution of ICEVs linked to disposable income

and affordability within income deciles in South Africa, needed to be established as a first step in this study.

No peer-reviewed publications were identified that provided forecasts of the BEV market penetration values for South Africa, linked to disposable income metrics and consumer affordability of passenger battery electric vehicles; thus a clear research gap.

For each scenario with BEV substitution of ICEVs, electricity demand and CO<sub>2</sub> emissions (reduction in the transport industry and increase due to BEV charging requirements using coal-fired power stations) was calculated. This study will also allow for Eskom to understand, with a renewables heavy electricity mix, if there is available capacity and available energy linked to the different electricity supply mixes, which can then be causally linked to various market penetration rates of BEVs. The results from the study can thus be used to plan future charging infrastructure, and ensure adequate electricity generation capacity in the country, while understanding the environmental impact in the transportation sector and the energy sector. The study also documents an adapted system dynamics modelling process to ensure the development and successful implementation of E-StratBEV, a process that builds on Sterman's (2000) framework, but diverges in terms of implementation elements in a corporate environment.

## 1.6 Research Design

The following steps were followed in developing the system dynamics E-StratBEV simulator for determining the affordability of passenger BEVs by the residential sector on a provincial level in South Africa:

1. *Develop* a comprehensive knowledge-base on the existing body of knowledge around: electric vehicle market penetration and related driving forces; the household ownership of passenger vehicles on a provincial level, so that substitution with BEVs based on established targets can be carried out; carbon emissions in the transport sector and power generation industry; and South Africa's supply mix and electricity demand forecasts in the residential sector driven by income distribution.
2. *Construct* a diagrammatic framework based on the operational and theoretical information linked to the problem definition, after conceptualisation, to illustrate the high level system architecture map of the dynamics impacting BEVs and the related environment, in support of the problem contextualisation. This step also required high

level assumptions; for example, the exclusion of the discrete raw material cost elements in the production cost module, to be agreed upon and possible proxies where no data was available for quantitative mathematical equations, such as the use of disposable income to determine BEV purchases. This step also included the development of supporting tools to provide further context to the problem such as a causal loop diagram and model boundary chart.

3. *Establish* a suitable modelling approach and choice of software to develop E-StratBEV. Various modelling approaches for studies on electric vehicles (EVs) were reviewed, including: agent based models (Al-Alawi & Bradley, 2013), consumer choice (Lane & Potter, 2007), stochastic models (Grahn, 2014), Markov modelling (Grahn, 2014), and system dynamics (Zhang & Qin, 2014). System dynamics was chosen as the modelling methodology since it offers causality and feedback loops to be built into model structures, which provides better understanding of the system variables and valuable sensitivity analysis to determine which variables influence the overall system (Barranquero, Chica, Cordón, & Damas, 2015). The timeframe for the simulator was 1993 until 2050, to coincide with the timelines for the Green Transport Strategy (DOT, 2016), and the Integrated Energy Plan (DOE, 2016).

4. *System analysis and model structure development.* In this study, due to the huge volume of hourly BEV data, preliminary data mining was necessary to filter the 2015 BEV data obtained from the Eskom-Nissan BEV pilot study (Langley, 2015), and so sub-routines (MS Excel Macros) were written to allow filtering and ordering of the data before further mathematical computations. iSee STELLA was used to design and develop the necessary stock flow feedback structure for the E-StratBEV.

5. The *validation* of the model was carried out by various subject matter experts, and any internal and external parties with an interest in the model, whereby model scenarios were run and the model initialisation and parameters were further calibrated according to experience and new information which emerged, a process which allowed for theoretical and empirical consistency checks (Sterman, 1984; Qudrat-Ullah, 2005). Empirical consistency included comparing the simulation results to historical data and ensuring closeness of fit.

6. The last step involved testing the scenarios against *applicable policies* to understand the implications using an adjusted system dynamics approach.

## 1.7 Thesis Structure

Figure 1.1 illustrates the diagrammatic framework of the thesis layout. Besides the introductory Chapter 1, which includes a general overview, background, problem statement and the research objectives, this thesis includes six additional chapters.

Chapter 2 was completed to support and inform the research objectives for the dissertation, through a literature review. This section details research on electric vehicle emergence in South Africa and its impact on electricity planning, factors affecting EV adoption, provincial disposable income and affordability of ICEVs, as well as carbon emissions in the transport and residential electricity sectors. Various modelling processes were also reviewed together with the related software most suited for this study.

The research approach is explained in detail in Chapter 3 and the methodology that was followed. It will also include the development tools for problem contextualisation, including the simulation timeframe and historical reference modes, the Causal Loop Diagram (CLD), the Model Boundary Chart (MBC), and the System Architecture Map (SAM). The data analysis necessary, preceding the simulation of the model structures is also explained in detail as part of the methodology followed.

Chapter 4 looks at the daily impact of BEVs on the daily electricity demand profile and related environmental considerations, as a precursor to the development of the long-term system dynamics strategic simulator known as E-StratBEV. A short-term simulator was developed because of the hourly resolution required for understanding the impact of BEV charging requirements on daily electricity load profiles, distances travelled, and annual environmental impacts with respect to carbon emissions.

The results obtained from the short-term simulator in Chapter 4 were then used as inputs into the E-StratBEV (developed at an annual resolution from 1993 until 2050), and included in Chapter 5. The development of the iSee Stella structures allowed for the running of various scenarios for sensitivity analysis.

Chapter 6 details the results obtained from various simulator runs to answer the research objectives, with a detailed discussion of the scenarios.



Chapter 7 provides the final research outcomes, conclusions and recommendations, which resulted from the research study. The limitations, shortcomings and opportunities for future research are also highlighted.

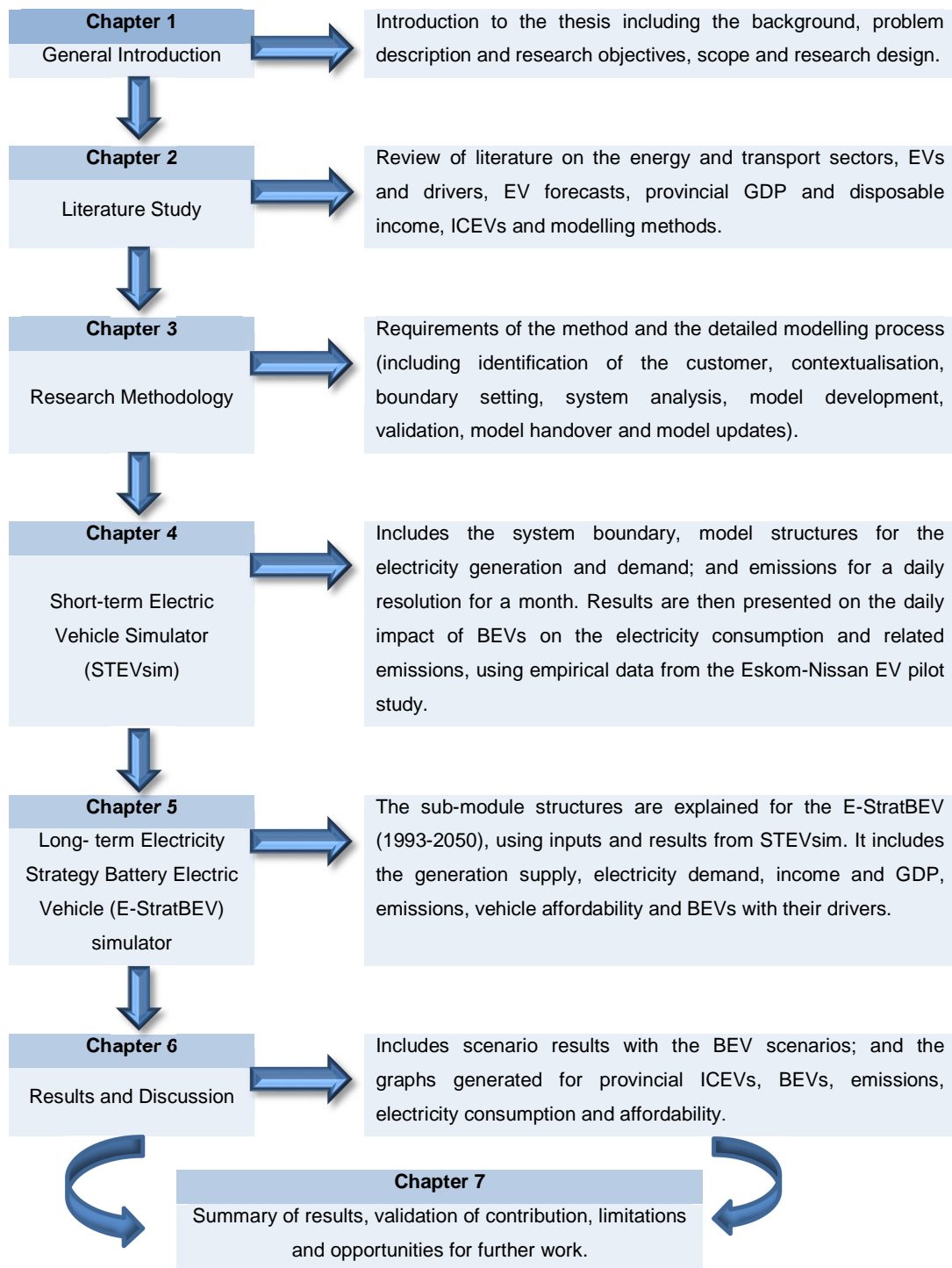

**Figure 1.1: Diagrammatic Layout of the Thesis**

## Chapter 2: Literature Review

---

### 2.1 Theoretical Considerations

This section provides an overview of the literature analysis, to support and inform the research objectives for the dissertation and outlines the theoretical context for the study. It is aimed at understanding the electricity supply and consumption dynamics in South Africa; the transport sector, electric vehicle drivers, forecasts and technology roadmaps; as well as the economy in terms of GDP and disposable income so that the modelling framework and process could be completed.

### 2.2 Approach to the Literature Analysis

Initial research included a review of the energy sector, followed by the South African electricity supply and demand dynamics. Thereafter, the transport sector was reviewed and research was carried out on the sales of passenger internal combustion engine vehicles (ICEVs) within each of the provinces. Following this, research continued into the timeline and history of the electric vehicle in South Africa, various types of electric vehicles, as well as the different battery types, charging characteristics, and storage capabilities. The drivers influencing the purchase of BEVs were reviewed in detail.

It was also necessary to include research on provincial GDP and disposable income dynamics within South Africa, so that electric vehicle market penetration based on regional affordability (as a function of disposable income) could be analysed spatially, for possible transport related infrastructural planning. Environmental issues remain paramount and as such the studies causally link various scenarios for BEV substitutions of ICEVs to the impact on carbon emissions in the transportation sector and in the energy sector. Behavioural patterns of EV users in terms of charging and commuting distances was also researched in order to understand potential impacts on the demand for electrical energy, and the impact on long-term energy (electricity) planning.

Various modelling methods were reviewed in Chapter 3 as part of the research methodology so that the most suitable modelling process could be chosen together with the appropriate modelling software.

## 2.3 The Energy Sector

In 2012, primary energy sources globally had a coal constitution of 29% of the energy mix, the highest being oil at 31.4%; whereas in South Africa, coal made up 77.2% of the primary energy mix (NERSA, 2017). This highlights the fact that South Africa's economy is very dependent on coal as the primary energy source and this reliance on coal has resulted in high carbon emissions (Winkler, 2007), earning South Africa 7<sup>th</sup> position, as one of the largest contributors of greenhouse (GHG) emissions per capita (Sebitosi & Pillay, 2008).

With respect to sectoral energy consumption and the national energy balance, the Department of Energy in South Africa reports that mining and manufacturing uses about 62% of the country's total electricity consumption; the residential sector consumes 20% while commercial and government services make up 15%. With respect to the transport sector, Haw and Hughes (2007) states:

*“Passenger transport over land is the largest consumer of energy followed by land freight. Road transport is a larger sub-sector than rail and air (DME 2001). Energy intensities are high in this sector due to an ageing vehicle fleet, low occupancy rates and poor maintenance of vehicles. Historically segregated residential patterns result in large commuter communities which increases fuel consumption and resultant emissions.”*

There may be a potential doubling in energy demand from 2010 to 2050 with the transport sector identified as resulting in a significant increase in energy demand of 34% in 2010 to 44% in 2050 (DOE, 2013).

### 2.3.1 Electricity Supply and Electricity Consumption in SA

The mining and manufacturing industries have high energy intensities<sup>2</sup> and are dominant electricity consumers, ~60% of national consumption in 2015, with the residential sector electricity consumption increasing from 16% in 1993 to 23% in 2013 (Deloitte, 2017).

Some of the determinants of residential electricity consumption include weather, location, floor area, the number electrical appliances, the household size, and the age

---

<sup>2</sup> The electricity intensity of a sector can be defined as the amount of electricity consumed to produce a given unit of output (Deloitte, 2017)

of household occupants (Kavousian, Rajagopal, & Fischer, 2013). The drivers of the national electricity consumption includes: the Gross Domestic Product (GDP), Final Consumption Expenditure (FCE) of households, the Index for manufacturing production volumes, the Index for mining production volumes (gold, coal, iron ore and total index (including and excluding gold)), the population, the number of households and the average household size, as well as the gold ore milled and gold ore treated (CSIR, 2016).

In this study a mathematical causal linkage was structured between GDP and residential electricity consumption, linked to the market penetration of passenger BEVs in the residential sector to determine the impact of BEV charging demands on the residential electricity consumption profile.

In 2012, the net energy sent out in South Africa was 233,601 GWh by Eskom, a State Owned Company (SOC), 277 GWh by Municipalities, and 42,770 GWh by independent power producers (NERSA, 2017). Eskom's supply mix consists of 37,913 MW of coal power plant capacity, besides other generating capacities such as 1,860 MW nuclear, 2,732 MW hydro-pumped storage, 2,243 MW gas cycle turbines, and 771 MW of hydro-electric power (Eskom, 2010). Electricity generation in South Africa has maintained a high coal base (Eskom SOC, 2017), with continued support for fossil fuels in South Africa (Montmasson-Clair, 2017).

NERSA (2017) reports that coal made up 93.2% of the primary energy sources for electricity generation in 2006 and this decreased to 79.7% in 2012, with statistics also reflecting an increase in bagasse<sup>3</sup> from a zero base in 2006 to 12.9% in 2012. The draft Integrated Energy Plan (IEP) by the Department of Energy indicates an energy mix by 2050 comprised of 15 GW coal, 20.3 GW nuclear, 13.3 GW open cycle gas turbines, 21.9 GW combined cycle gas turbines, 17.6 GW solar PV; 37.4 GW wind, 2.5 GW from the Inga hydro-electric project, 250 MW from landfill gas and 500 MW from demand response initiatives (DOE, 2016).

This study allowed scenario analysis of the impact of BEV market penetration on electrical energy consumption in the residential sector with a coal heavy electricity mix and then with a renewable heavy mix. The difference between available capacity and available energy linked to the different electricity supply mixes was causally linked to

---

<sup>3</sup> Bagasse is a waste product from sugar refineries and electricity generation from this energy source is for own use by the refineries (NERSA, 2017)

various market penetration rates of BEVs to determine the impact on the required energy sent out in the residential sector.

### **2.3.2 Transport Sector in South Africa**

The different subsectors of the transport sector include the infrastructure and operations of rail, pipelines, roads, airports, harbours as well as the cross-modal operations of public transport and freight. South Africa has been recognised as having the longest road network in Africa at 747,000 km (Doke, 2015). A significant fraction of the rail freight sector has been displaced with the road freight sector over the last 20 years due to the flexibility speed and adaptability of transporting goods between cities, at the detriment of the road infrastructure, adding to environmental concerns emerging from road transport vehicles (SOE review, 2016). Furthermore, since approximately 97% of the transport energy comes from liquid fuels, there is expectedly, concern for environmental impacts due to transport fuel use (Venter & Mohammed, 2013). The most dominant fuel was identified as being petrol (53.3%), followed by diesel (34%) and jet fuel (10.9%).

Research indicates that the fuel consumption per vehicle is a function of vehicle engine size, fuel type, traffic conditions, environmental conditions and driving style. Projections of energy demand in the transport industry, based on current vehicle growth trends, indicate a potential doubling of CO<sub>2</sub> emissions by 2050 (Merven, Stone, Hughes, & Cohen, 2012), which warrants an urgent need for roll-out plans to reduce greenhouse emissions and energy consumption, and to protect the environment; considering that the transport sector accounted for about 13% of national greenhouse gases in 2012 (Seymore, Inglesi-Lotz, & Blignaut, 2014).

#### *2.3.2.1 Factors Influencing the Demand for Passenger ICEVs*

The Motor Industry Development Program (MIDP) was formed in South Africa in 1995 with a goal to transform the automotive industry. It was through this program that import duties on foreign vehicles and components were reduced, while encouraging incentives for export (Barnes & Black, 2003). The amended Automotive Production Development Programme (DTI, 2012), introduced after the MIDP, supported localisation and the expansion of manufacturing components in South Africa, effectively promoting an increase in vehicle sales.

Besides supporting programs, the demand for transport and vehicles, Litman (2017) identified a host of influences including: demographics (employed and wealthy consumers purchase private vehicles) (Moeckel & Yang, 2016), economic activity (business activity affects the type of vehicle required), transport options (community which have public transport depend less on private vehicle usage) (Cheyne & Imran, 2016), geography and land use patterns (including factors such as vehicle density, road network, building design and parking) (Rodrigue, Comtois, & Slack, 2017), demand management strategies (includes incentives to reduce private vehicle travel) (Cheng & Chang, 2015), and cost (vehicle price, road, parking, emissions, fuel, insurance, public transport) (Pasaoglu, Harrison, Jones, Hill, Beaudet, & Thiel, 2016). When it comes to the theory of demand, the objectives of consumers is to optimise and maximise the best combination of affordable commodities (Clarkson, 1964).

The purchase of motor vehicles is affected by the consumer confidence index, that is, if the consumer is not optimistic about the economy then they are more likely to be sensitive to price and income changes. For road passenger transport, GDP growth was linked to increased need to commute and greater personal wealth which meant more money being available for vehicle purchases, in turn resulting in a demand for transport and transport fuel (DEA, 2014). A study by Rubin (2006), noted that North Americans have become wealthier, thus purchasing, more private, personalised transportation services; while technological advances in vehicle safety, performance and value for money has resulted in increased use of light-duty vehicle use. Studies by Mervin et al. (2012) indicate that in South Africa, the number of registered vehicles has followed the GDP growth trend more closely rather than population growth.

The demand for motor vehicle purchase was seen to be equivalent to the demand for durable commodities, that is, the demand increases as incomes increase. The following Figure 2.1 shows the South African passenger motor vehicle market from 1995 until 2005 showing an increasing sales trend with passenger vehicles (Zide, 2012).

The income effect is when consumers who were unable to enter the market due to the lack of affordability linked to low income, can now enter the market (Smit, Dams, Mostert, Oosthuizen, Van Der Vyver, & Van Gass, 1996). Due to the evidence obtained from the literature review (Dargay & Gately, 2001) that income is considered one of the most important determinants in car ownership decisions, this study will use historical disposable income data per decile per province and determine the affordability of ICEVs.

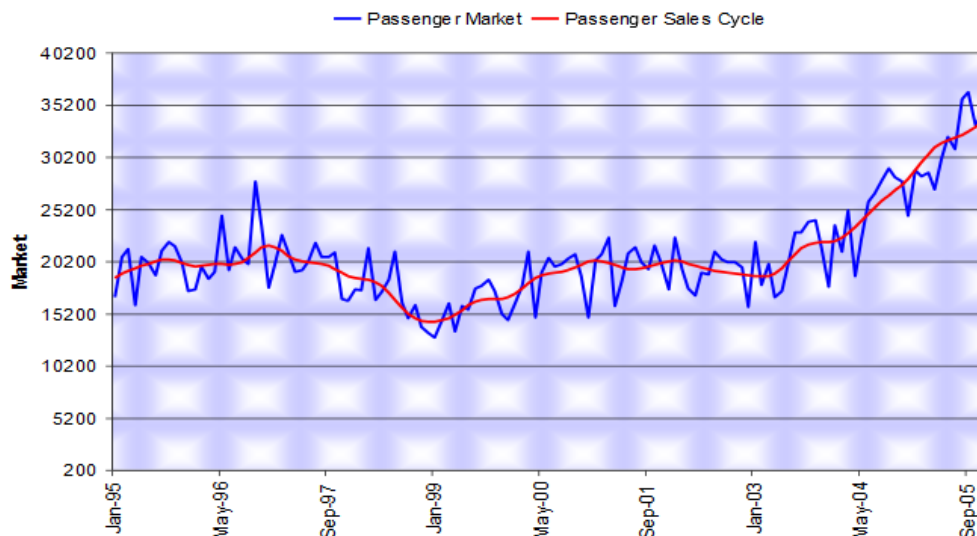

**Figure 2.1: Sales of Passenger Motor Vehicles in South Africa**

Source: Zide (2012)

In a study by Shende (2014) on consumer behaviour of the passenger vehicle customer, consumer behaviour parameters identified included social (e.g. lifestyle, road safety and infrastructure), economical (e.g. disposable income, loans, fuel and product price), political (e.g. government taxation and government policies), product and technology (e.g. fuel efficiency, vehicle performance, reliability), geographic (e.g. education, occupation, age) and psychographic (e.g. interests, values, opinions).

## 2.4 Electric Vehicles

As part of South Africa's Nationally Determined Contribution, the Department of Transport has committed to a 5% reduction in emissions in the transport sector by 2050. Due to the need to reduce its carbon emissions, South Africa compiled the Green Transport Strategy in 2016, with a focus on the promotion of green transport technologies, including the uptake of the electric vehicle (EV) and hybrid electric vehicle technologies (DOT, 2016). This section focused on investigating the existing experience and understanding various issues related to BEV development and commercialisation so that these dynamics could be built into the structure of the model.

### 2.4.1 Brief History of Electric Vehicles including Commercialisation

Contrary to popular belief, the EV is not a modern invention and has been around for over 100 years with France and England being the forerunners in the late 1800s



(Høyer, 2007). Thomas Parker is credited with building the first electric vehicle in Wolverhampton in 1884 (Figure 2.2). The Americans then followed with the first commercial application in 1897 as a fleet of New York City taxis (Wakefield, 1994). The 1902 Wood's Paeton had a range of 18 miles, a top speed of 14 mph and cost \$2,000 (Smart, Francfort, Karner, Kirkpatrick, & White, 2009). In America, electric vehicles were rapidly replacing gasoline-driven cars in the early 1900s since EVs did not have vibration, smell, noisiness and no gears. Although steam powered cars also did not have gears, they had long start up times of up to 45 minutes on cold mornings (Kierzkowski, 2009).

The decline of the EV after the peak production in the 1920s was due to (Chan, 2013; Santini, 2011):

- *Improved road infrastructure* connecting cities and requiring longer range vehicles;
- *Reduced oil and gas prices* increasing affordability of gasoline driven cars; and
- *Economies of scale* for the internal combustion engine initiated by Henry Ford meant an average vehicle cost of \$650 as opposed to the EV, which sold at \$1,750.

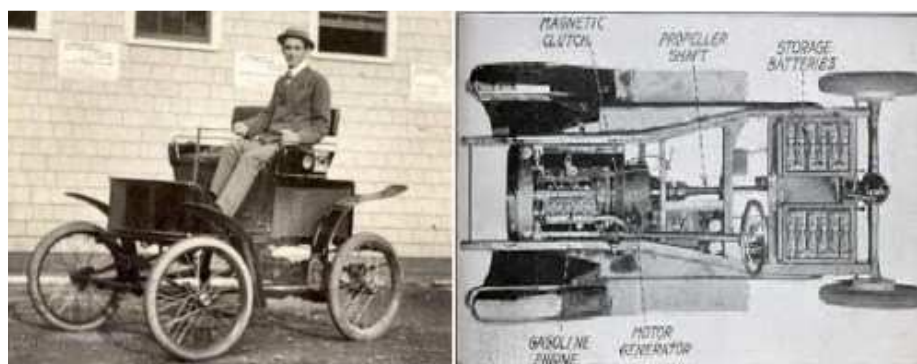

**Figure 2.2: First Electric Vehicle – Thomas Parker**

Source: Sudhansu (2017)

The resurgence of alternative fuelled vehicles arose in the 1960s due to the exhaust emissions from internal combustion engines, and the need to reduce dependence on crude oil imports. It was in this period when the Boyertown Autobody Works jointly formed the Battronic Truck Company with Smith Delivery Vehicles Ltd. of England, and delivered the first electric truck which had a speed of 25 mph, a range of 62 miles and a payload of 2,500 pounds (Electric Vehicle News, 1998). Battronic also produced about 20 passenger buses in the mid-1970s. Thereafter, Sebring-Vanguard produced the Citicar, which had a top speed of 44mph and a range of 50 to 60 miles, whilst Elcar Corporation produced the Elcar that had a top speed of 45 mph and a range of 60 miles (записи, 2014; 1976 Elcar).



In 1975, the American Motor Company delivered 350 electric Jeeps to the United States Postal Service to be used in a test program with each vehicle having a top speed of 50 mph and a range of 40 miles at a speed of 40 mph, with a battery recharge time of 10 hours (Smart, Francfort, Karner, Kirkpatrick, & White, 2009). Since 1990 onwards, there have been renewed efforts to revert to electric vehicles due to several legislative and regulatory actions. In the US, the Department of Energy, as well as a number of vehicle conversion companies, are involved in EV development. Some EVs such as the Ford Ecostar being powered by alternating current motors and sodium sulphur batteries, with a top speed of 70 mph and a range of 80 to 100 miles (Car History, 2009). Several EVs became available in the United States in 1998 including the Toyota RAV4 sport utility, the Honda EV Plus sedan and the Chrysler EPUC minivan; all equipped with advanced nickel metal hydride battery packs but a price range of \$30,000 - \$40,000 (Bellis, 2016).

Tesla, Inc. was founded in 2003 by Elton Musk and a group of engineers in Silicon Valley. One of their goals focussed on creating EVs and supporting sustainable transport with mass market EVs. Tesla's business model focuses on the entire supply chain from manufacturing to distribution, thus placing them in control of cost control and business sustainability (Bilbeisi & Kesse, 2017). In 2012, Tesla launched Model S, the first electric sedan with an acceleration of 0 to 60 mph in five seconds and a charge, which allows 265 miles (Tesla, 2016). Tesla now has more than 50 000 vehicles worldwide and provides free 20 minute supercharging facilities on routes connecting North America, Europe and Asia Pacific. Tesla has also embarked on the construction of a Gigafactory in Nevada with other stakeholders to produce more lithium ion cells (Carter, 2014). The aim of the Gigafactory is to produce battery packs for cars as well as for stationary storage thus improving the reliability of the electrical grid, by year 2020.

The year 2020 has also been set as a target to reduce the cost of batteries by at least 30%, however, Musk indicates that it will be the advent of super-capacitors for energy storage, rather than batteries, which will fundamentally change the EV landscape. Tesla aims to have doubled their superchargers worldwide from 3 600 to 7 000 by 2018, their supercharger network giving them the competitive advantage. Erich Joachimsthaler, founder and CEO of Vivaldi (which works with German luxury carmakers) states:

*“Nobody doubts that the future will be electric. The car companies dragged their feet with electric. Now they are being dragged into it by Tesla and by regulations.”* (Welch, 2017).

In South Africa, the earliest research on EVs dates back to the early 1970's when the Department of Mineral and Energy Affairs and the CSIR demonstrated the use of EVs as an alternative to import oil. Battery studies started at the CSIR as far back as 1974, with a formal agreement between the CSIR, SAIDCOR, De Beers and Anglo American signed in 1977 for further investment in battery initiatives (Thackeray, 2011). In 1982, Anglo American acquired facilities in Derby (United Kingdom) to expedite the evaluation of sodium/metal chloride battery technology for use in electric test vehicles, after significant progress was made with this battery technology by the CSIR. In 1984, a multi-kWh Zebra<sup>4</sup> battery was built and demonstrated in an electric vehicle. Further collaborative research then continued with the National Energy Council and Eskom, the state-owned national electricity utility, between 1988 and 2002. Some of the vehicles piloted during this time included a 25 seater electric bus for game viewing in the Kruger National Park (Figure 2.3). The electric bus had a squirrel cage induction drive system with lead acid batteries and a range of about 80 km was achieved per charge using lead acid batteries.



**Figure 2.3: Game Viewing Electric Bus**

Source: Langley (2012)

The programme also included two VW shuttle buses (one on Robben Island and the other in Kyalami Business Park), with a range of about 40 km per charge using lead acid batteries, demonstrated in Figure 2.4 (Langley, 2012).

---

<sup>4</sup> Zebra was given after the project Zeolite Battery Research in Africa.



**Figure 2.4: Shuttle Bus for Robben Island**

Source: Parma (2017)

The Joule Project by Optimal Energy spanned 2004 until 2012 and the electric family car was developed, and despite it being introduced at the Paris Motor Show in 2008, it was never commercialised (Eliseev, 2012). The project was perceived to have many risks so the assets were transferred to an initiative established as the uYilo eMobility Technology Innovation Programme. The six seater multi-purpose vehicle had two lithium ion battery packs to ensure a 400 km driving range with regenerative braking and a body made from glass-carbon composites and plastic (Turbosprout, 2008).

In the years that followed, South Africa saw the advent of various other initiatives and roll-outs to support the introduction of EV technology. The Department of Trade and Industry launched the EV Industry roadmap for South Africa in May 2013 (DTI, 2012) while in the same year, the Department of Environmental Affairs launched their green fleet. In 2014, an initiative known as the Electric Vehicle Infrastructure Alliance (EVIA) (EVIA, 2017) was developed with stakeholders such as uYilo, SANEDI, CSIR-based GridCars, BMW and Nissan, with the purpose of developing EV infrastructure hardware and software standards, including the roll out of charging stations at appropriate locations (Parmar, 2017).

EVIA was then renamed as the Electric Vehicle Industry Association at a 2016 launch. Eskom, a State Owned electricity utility in South Africa, and Nissan then launched a battery electric vehicle (BEV) program to pilot ten motor vehicles (Figure 2.5) in 2014, the results of which were used as input in the preliminary work for this study (Langley, 2016). The first commercially available battery electric vehicle (BEV) in South Africa was the Japanese imported Nissan Leaf, introduced in 2013, followed by the BMW's i3, which was made available in February 2015 (Grant, 2014).



**Figure 2.5: Nissan Leaf EV in the Collaborative Eskom Pilot**

Source: Langley (2016)

Other electric vehicles currently retailing in South Africa include the BMW i8, the Kia Soul EV and the Tesla Model S (Autotrader, 2015). As of January 2018, approximately 375 EVs were sold in South Africa (Wheels24, 2018).

#### 2.4.2 Types of Electric Vehicles

The categories of electric vehicles include: battery electric vehicles (BEVs), hybrid electric (HEV), plug-in hybrid electric vehicle (PHEV) and fuel cell electric vehicles:

- a) **Battery Electric Vehicles (BEV):** The electric drivetrain for the basic electric vehicle configuration includes the battery, an inverter, and the electric motor. Direct current is passed from the battery to the inverter, which converts it to alternating current and provides this to the electric motor. The electric motor then converts the electric energy into mechanical energy. The electric motor also serves an electric brake. It acts as a generator and converts braking energy into electric energy, which is stored in the battery through the inverter. BEVs have high torque at a wide range of speeds; and have high efficiencies of up to 90% compared to ICEVs (30-45%) (Sustainable Energy Authority of Ireland, 2010).
  
- b) **Hybrid Electric (HEV):** Includes petrol or diesel engines to power the electric drive motor and the surplus electricity is stored in a battery (less engine revving and idling). It is expected that HEVs can save 15%-70% in annual fuel costs, but cost between 20% to 50% more than ICEVs in the same class of vehicle (Mi & Masrur, 2017; Curtin, Shrago, & Mikkelsen, 2009). The HEV is a parallel hybrid setup with gas provided to a conventional engine and has batteries supplying power to an electric motor. The vehicle is powered by the engine or the electric motor, with the vehicle recharging the batteries during normal driving.

- c) **Plug-in Hybrid Electric Vehicle (PHEV):** These vehicles are similar to the hybrid, but use a larger battery to allow energy input from the electricity grid; returns to petrol or diesel energy when the battery charge is depleted. The PHEV has a series hybrid setup where the electric motors and the gas engine are linked in a line. The electric motor powers the vehicle and the gas engine's function is to recharge the battery when an electrical outlet is not available (Kalhammer, Kamath, Duvall, Alexander, & Jungers, 2009).
- d) **Fuel cell electric vehicles:** Hydrogen gas is converted into electricity and power up the electric motor and battery. Since these vehicles are powered by electricity, they are considered electric vehicles, however, their ranges and refuelling processes can be compared to those of trucks and conventional cars. Converting hydrogen gas into electricity produces only water and heat waste. Refueling fuel cell vehicles is done at hydrogen fuelling stations and takes less than 10 minutes, with 16 hydrogen stations in California in 2016 and 40 worldwide (Curtin & Gangi, 2016).

For this study, only the BEV was considered due to empirical data available from the three-year pilot study between Nissan and Eskom SOC (Langley, 2015).

#### 2.4.3 Batteries for Electric Vehicles

The value chain of EV batteries consists of seven steps: component production (e.g. anode, cathode, binder, electrolyte etc.), cell production (single cell production and assembly), module production (of smaller cells into larger modules), pack assembly (integration of modules with systems to manage power, charging and temperature), vehicle integration (of battery pack into the vehicle design with necessary interfaces), use (essentially the time the battery is used) and lastly reuse and recycling (deconstruction of the battery) (BCG, 2010). The high cost of batteries for BEVs, as well as the deterioration rates, makes resale values of BEVs uncertain.

There are various types of batteries to choose for EVs. The types of batteries include the following three:

- a) **Lead acid batteries:** Affordability and the ability of lead acid batteries to provide high surge currents for the EV have made these types of batteries popular. The pollution problems arising from the smelting, making and disposal of lead acid

batteries has resulted in a drive to eliminate these, e.g. the Chinese Government has reduced lead acid manufacture to 42% the volume in 2010 (Harrop, 2011).

- b) **Nickel metal hydride (NiMH):** Work on the NiMH battery began in 1967 and they only became available in 1989. They have a greater energy density and double the specific energy (68 Wh/kg) of lead acid batteries and are thus lighter with less energy costs to propel the BEVs (Mok, 2017). Mok (2017) also indicates that problems arise in the self-discharge rates of up to 12% per day under normal room temperature conditions and generally have lower charging efficiencies than other batteries. These batteries were used in EVs such as the General Motors EV1, the Honda EV Plus and the Ford Ranger EV.
- c) **Lithium ion batteries (LIB):** Lithium ion batteries may have various battery chemistries, but the ones most commonly applied for automotive applications include: lithium-cobalt-aluminium (NCA), lithium-nickel-manganese-cobalt (NMC), lithium-manganese-spinel (LMO), lithium titanate (LTO), and lithium-iron phosphate (Battery University, 2016). The majority of EVs use these batteries including the Tesla and the Nissan. In lithium ion batteries, the positively charged lithium ions travel between the anode and the cathode in the electrolyte. Unfortunately, they also have disadvantages such as leaked lithium ions on the battery's surface when the lithium heats and expands during charging. The performance is being improved by various research and development initiatives and the average lifespan is 5-7 years. Lithium ion batteries are very expensive; average range of 60 to 80 miles costs between \$10,000 and \$15,000, an average of \$522-620 per kWh, which is approximately one third the entire cost of the vehicle (BCG, 2010). Although current prices are declining due to economies of scale, there may still be several years before the commercial feasibility targets are attained, estimates by Bereisa indicate \$135-\$155 per kWh by 2025 (Green Car Reports, 2016).

BCG (2010) discusses a few important features of lithium-ion technologies including battery life span, specific energy, charging time and cost, summarised below:

- **Battery life span** is measured in two ways: cycle stability (number of times charging and discharging before degrading to 80% original capacity at full charge), and overall age (number of expected useful years). Most manufacturers plan for a ten year life span; for example, if an EV requires a 12 kWh battery, the specification will most likely be 20 kWh instead so that after ten years and 40% performance degradation, there is still energy capacity for normal operation (however, it does mean an increase in size, weight and cost).

- The **specific energy** of batteries is ~ 1% of that of gasoline, hence batteries limit the driving range of EVs to 250/300 km per charge. The nominal energy densities of battery cells are 140-170 watt-hours per kg compared to 13,000 Wh/kg for gasoline. The specific energy of a battery pack is then 30-40% lower, or 80-120 Wh/kg.
- In terms of **charging time**, it generally takes 10 hours to charge a 15 kWh battery, plugged into a standard 120 Volt outlet. Charging at a 240 Volt outlet (40 amps) can take up to 2 hours while charging at a commercial three phase charging station can take 20 minutes.
- **Battery component costs** can be calculated dependent or independent of mass volume production. The volume production is linked to industry experience and automation. Volume independent costs would include aspects such as raw materials, labour rates and general machinery.

Table 2.1 provides calculations on various types of EVs (range, energy consumption and cost of energy) (Buchmann, 2017). The Tesla technology appears to allow the best range at 360 km for the Tesla S85 with its 90 kWh battery capacity.

**Table 2.1: Comparisons of Various EV Makes**

Vehicle Make	Battery (kWh)	Range (km)	Energy Consumption (Wh/km)	Energy cost(\$/km)
BMW i3	22	135	165	\$0.033
GM Spark	21	120	175	\$0.035
Fiat 500e	24	135	180	\$0.036
Honda Fit	20	112	180	\$0.036
Nissan Leaf	30	160	190	\$0.038
Mitsubishi MiEV	16	85	190	\$0.038
Ford Focus	23	110	200	\$0.040
Smart ED	16.5	90	200	\$0.040
Mercedes B	28	136	205	\$0.040
Tesla S 60	60	275	220	\$0.044
Tesla S 85	90	360	240	\$0.048

Source: Buchmann (2017)



#### 2.4.4 Operational Differences between the Internal Combustion Engine Vehicle and the Electric Vehicle

In an internal combustion engine vehicle, air and fuel are compressed using pistons in the combustion chamber (hence the term internal), ignited by the firing of spark plugs. The internal combustion engine transforms the thermal energy from burning the air-fuel mixture into mechanical energy. The drivetrain for the ICE vehicle includes U-joints, axle shafts, the differential, the CV (continuous variable) joints and the driveshaft.

The distinct physical differences between EVs and the ICE vehicles is that the EVs do not have an exhaust system (emission free operation) and do not have gas tanks. Other key differences between the two types of vehicles are as follows:

- a) *Energy storage and efficiency:* EVs store energy in a battery and ICE vehicles use energy generated by igniting fuel (petrol or diesel). Petrol and diesel fuel contain more internal energy per unit mass compared to the energy density of the EV battery so the battery pack has to be very large compared to the size of the fuel tank, however this has been changing with the advancement in battery technologies. Efficiency ranges for EVs are quoted to be between 75-90% compared to ICEVs which range between 20-30% (Post, 2017).
- b) *Environmental impact:* EVs have zero tail-pipe emissions but require electricity for charging so the type of energy source determines how low the overall impact on the environment will be, since they rely on regional power plants to charge the batteries. ICEVs use energy sources from fuels which release carbon dioxide and impact the environment (Brennan & Barder, 2016). There are also environmental impacts from BEVs due to the manufacturing of the battery packs; however, this impact was excluded from the scope of this study since the entire life cycle for both BEVs and ICEVs would then have to be conducted which is in itself another research study.
- c) *Maintenance:* The maintenance of EVs should be less than that of ICE vehicles due to the lack of a gearbox and less moving parts (IDAHO, 2015).
- d) *Cost:* At this stage, the retail cost of EVs is higher; however, the charging and running costs are less, as petrol and diesel fuel prices escalate (Palinski, 2017).

Nissan South Africa offered to lease 10 Nissan Leafs over a period of 3 years to Eskom SOC prior to it being released to the public (Langley, 2012). Their objectives were to



have the vehicles evaluated, promote the use of BEVs in workplace commuting and transport, as well as to restrict carbon emissions in the transport industry. A database was populated with BEV data from the 10 cars over the 3 years and only 1 car was monitored in the 1<sup>st</sup> year, due to the delay in setting up the data logging system. The empirical logged for this study formed the basis for interrogation and for applied information for inclusion in the model developed, for this research study. The mechanical features of the Nissan Leaf are as follows (Langley, 2012):

- 80 kW AC synchronous electric motor with a 24 kWh lithium-ion (Li-ion) battery 360V,
- Max torque 280Nm/min<sup>-1</sup> and maximum speed 145 km/h,
- 50kW quick charger,
- Acceleration 0-100km/h 11.9 sec.

A Nissan Tiida was compared to the Nissan Leaf (MacColl, 2013), as summarised in Table 2.2.

**Table 2.2: Comparison between a Combustion Engine and an Electric Vehicle**

	Nissan Tiida	Nissan Leaf
Power Output	80 kW, 153 Nm	80 kW, 250 Nm
Cost (R)	222,000 (1,6 L)	R440,000
Range (km)	600	160
Cost per Km (R/km)	1	0.17 (R25 for 150 km)
		

Source: MacColl (2013)

After 3 years of testing, the project ended in March 2016 and the following information was captured on a central database (Langley, 2015):

- The total distance covered in kilometres for a certain time period. The trip distances showing the average short distance and average long distances covered by the vehicle e.g. used for short trips with 90 of them being between 0 to 5 km long and 40 of them 5 to 10 km long.
- The weekend usage relative to the weekday usage.
- The type of chargers used (whether the level 2 chargers which is the normal 15 amp 220 V supply or the super chargers found at the Nissan dealership and at the Eskom Head Office).

- The charging profiles for a specific vehicle, with the times when the vehicle was most and least charged.
- The percent battery charge at the start of the trip and the end of the trip (in percent).

The data was interrogated and analysed before developing the model structure for this study.

#### 2.4.5 Factors affecting EV Adoption

Various factors determine the success of EV adoption such as supporting infrastructures, regulatory frameworks, financial incentives, consumer perceptions, public policies and strategies, as well as creative business models to market EVs (Haddadian, Khodayar, & Shahidehpour, 2015). Table 2.3 provides a summary of internal factors, external factors and policy mechanisms that affect the adoption of electric vehicles (Coffman, Bernstein, & Wee, 2015).

**Table 2.3: Factors Affecting Electric Vehicle Adoption**

Internal Factors	External Factors	Policy Mechanisms
<ul style="list-style-type: none"> <li>• Purchase Price and Battery Costs</li> <li>• Driving Range</li> <li>• Charging time</li> </ul>	<ul style="list-style-type: none"> <li>• Fuel Prices</li> <li>• Consumer Characteristics include education, gender, income, number/type of cars owned, level of environmentalism, and love of technology</li> <li>• Travel Distance</li> <li>• Charging Station Networks</li> <li>• Public Visibility and Vehicle Diversity</li> </ul>	<ul style="list-style-type: none"> <li>• Subsidies and Other Incentives</li> <li>• Raising Awareness regarding vehicle purchases</li> <li>• Supporting Charging Infrastructure Build-up</li> <li>• Taxes</li> </ul>

Source: Coffman, Bernstein, & Wee (2015)

##### 2.4.5.1 Subsidies and Other Incentives

Studies indicate that in order to promote the adoption of electric vehicles, subsidies may have to be offered to manufacturers, instead of consumers (Ramayia, 2013). The South African Government considered reimbursing manufacturers of electric vehicles 35% of their production costs over 3 years if the proposed Department of Trade and Industry's Electronic Vehicle Industry Road Map (EVIRM) was approved by Cabinet,

requiring a minimum of 5000 vehicles per manufacturer (DOT, 2013). The other consideration was to encourage the public to buy EVs by offering incentives, such as personal tax rebates, reductions in VAT, and the reduction in vehicle registration costs. Electric vehicles would require manufacturers to define the standards, developed mainly by ISO. As far as grid-connected EVs are concerned, standards need to be agreed on jointly between the vehicle manufacturers and the electricity supply industry as represented in the IEC (Welgemoed, 2013). Standardisation of the charging system would also be required; these charging modes are included in the IEC 61851 standard (IEC, 2017).

#### *2.4.5.2 Import Taxes*

Carel Snyman, from the South African National Energy Development Institute, indicates that electric vehicles get charged a duty fee of 25%, while conventional motor vehicle imports come in at 18% duty, additionally since electric vehicles are regarded as a luxury item, an additional ad valorem tax is charged thus increasing the total import taxes on electric vehicles to 42% (Brown, 2016). Although no decision has yet been formalised, BMW submitted a formal application in December 2016 to the International Trade Administration Commission of South Africa for a three year 0% import duty on electric vehicles, followed by a 10% import duty (Venter, 2017).

#### *2.4.5.3 Battery Costs*

A McKinsey & Company study indicates that the price of battery packs has decreased by about 80% from 2010 to 2016, however, battery costs continue to be the most expensive component in the manufacturing process (Knupfer, Hensley, Hertzke, Schaufuss, Laverty, & Kramer, 2017). It is foreseen that economies of scale and improvements in manufacturing, besides material cost optimization may support the drive towards lower battery costs.

In August 2017, a report was compiled by the Union of Concerned Scientists (Reichmuth & Goldman, 2017) which included an EV battery cost forecast (Figure 2.6) based on data from various sources including Air Resources Board (ARB, 2017), Bloomberg (Watanabe, 2017), and the International Council on Clean Transportation (Slowik, Pavlenko, & Lutsey, 2016). The results indicate that the decreasing trend in battery costs could result in the \$125-\$150 target which would make BEVs competitive with their gas fuelled ICEVs.

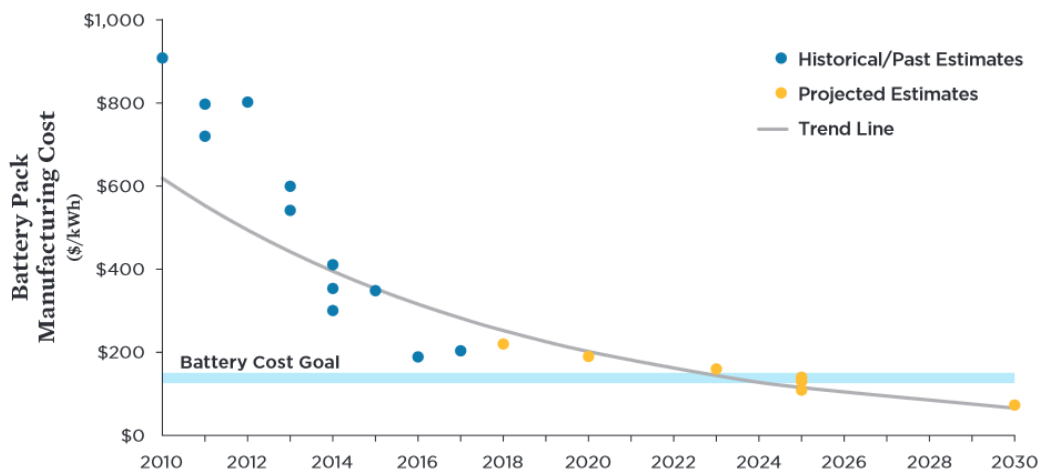

**Figure 2.6: EV Battery Pack Manufacturing Costs**

Source: Reichmuth & Goldman (2017)

In a report published by McKinsey & Company, battery costs went from ~ \$1,000 per kWh in 2010 to ~\$227 per kWh in 2016 and is expected to fall below \$100 per kWh by 2030 (Knupfer, Hensley, Hertzke, Schaufuss, Laverty, & Kramer, 2017). In a study by the International Energy Agency, information received from the U.S. Department of Energy indicates declining battery cost trends (Figure 2.7) and that increased production volumes of battery packs from 25,000 units to 100,000 units for a 100 kWh BEV battery pack, can result in a 13% decrease in production costs per kWh (IEA, 2017).

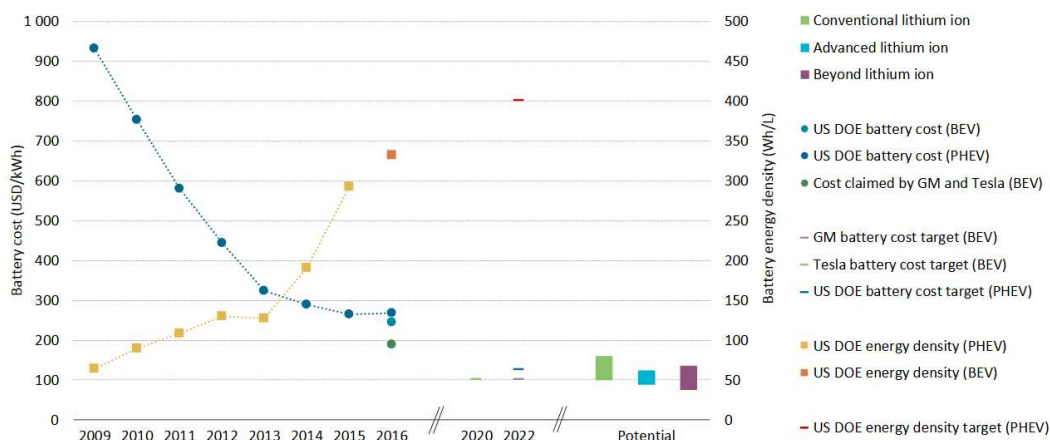

**Figure 2.7: IEA EV Battery Pack Costs**

Source: IEA (2017)

Howell (2017) indicates that increasing the pack size from 60 kWh to 100 kWh (resulting in an increased range from 200 km to 320 km) may also result in a 17% cost

reduction per kWh at pack level. Short-term 2015 costs of lithium-ion batteries were averaged at \$400 per kWh to \$600 per kWh and in the long-term (beyond 2015) were forecast to range from \$250 per kWh to \$300 per kWh (Gerssen-Gondelach & Faaij, 2012).

There was an estimated learning rate of 5% in 2008 by the Deutsche Bank adjusted to 7.5% in 2010 and an estimated 6-8% annual decline in battery costs by Hensley, Knupfer and Pinner (2009).

#### *2.4.5.4 Charging Infrastructure*

Charging can either take place at work or at home or public places, and battery chargers are critical in promoting EV adoption (Yilmaz & Krein, 2013). The factors identified as challenges to EV charging include (Mahmud, Town, Morsalin, & Hossain, 2017): use of common standard component since devices and standards are not universal at the moment; inability to have EV infrastructures shared by lots of parties; advancement in combining communication and control devices using a single charger; cost reduction of fast chargers; variability in type of chargers resulting in different electricity demand responses; use of renewables for fast chargers; location of charging stations; and the potential upgrading requirement by electricity utilities of their lines capacities, substations and transformers etc. Pasquale Romano (CEO of Chargepoint, one of the largest charging station providers in North America & Europe) says workplaces should have about one charger per 2.5 EVs and retail stores need one for every 20 EVs, while highways would need one every 50 – 120 km (Raymond, 2017).

This study linked a proportional sliding scale of charging stations to the number of possible additional BEV's.

#### *2.4.5.5 Consumer Perception and Consumer Behaviour*

Consumer perception has also been identified as a potential barrier to increased EV adoption; for example, the consumer's ability and knowledge to calculate and compare the financial benefits of EVs and ICEs, consumer perceptions with respect to the environment, fuels and vehicles, social norms, and emotive and psychological triggers (Rezvani, Jansson, & Bodin, 2015). A known emotive trigger influencing consumers is "Range anxiety", is a term which started in 2013, when consumers started driving the first commercial passenger electric vehicles such as the Nissan Leaf which had a travelling range of 120 km. With an improvement in battery technology, driving ranges

are expected to improve thus reducing “range anxiety” as a barrier to EV adoption (The Economist, 2017). Charging behaviours are as a function of location (at home or public station) and type of vehicle (Kaczmarczyk, Fiedler, Štohl, & Bradáč, 2012). From the viewpoint of an electricity utility, it is important to understand the customer behaviour with respect to charging times, and to determine what impact this will have on the grid and the demand profile. It is theoretically assumed that EV users plug in their vehicles when arriving at work or back at home. The peak is assumed to coincide with the usual evening peak between 18h00 and 21h00 which would naturally present a problem (Welgemoed, 2013).

Studies by Cheron and Zins (1997) indicate the factors which mostly influence human behaviour around EVs include: comfort, reliability, durability, power, road handling, safety, economy, competitive price; feelings that they would run out of power/ have an accident/ breakdown/ stuck in traffic/ have a flat tire. A study on factors driving consumer resistance to EV purchases revealed that the influence of factors changed in different countries depending on their market characteristics (Bessenbach & Wallrapp, 2013). Table 2.4 summarises the factors affecting the overall value of EVs as perceived by consumers and includes driving range, speed, model variety, engine sound, acceleration, value for money, safety and design.

**Table 2.4: Factors Affecting Overall EV Value**

	<b>Norway</b>	<b>%</b>	<b>Sweden</b>	<b>%</b>	<b>Denmark</b>	<b>%</b>	<b>Germany</b>	<b>%</b>
1	Range	100	Model Variety	73	Model Variety	93	Model Variety	89
2	Model Variety	86	Range	71	Range	75	Range	79
3	Speed	57	Value for money	53	Value for money	53	Speed	74
4	Size	57	Acceleration	53	Engine sound	47	Value for money	63
5	Acceleration	43	Speed	47	Acceleration	38	Engine sound	55
6	Value for money	43	Size	33	Size	33	Size	47
7	Safety	36	Image	21	Speed	31	Design	34
8	Design	36						
9	Engine sound	36						

Source: Bessenbach & Wallrapp (2013)

For consumers in Germany, value model variety, range and speed featured high. The Norwegians ranked engine sound and value for money very low possibly due to their

low price sensitivity. Although the Norwegians are very critical towards functional value, the Swedes were less critical and perceived the lack of engine sound to be of a high risk. As far as the risk barriers are concerned, the lack of sound was seen as a risk for more accidents.

Table 2.5 shows the perceived risk barriers to adoption due to eMobility uncertainties and include factors such as the proximity of charging stations, battery capacity, purchase price, uncertainty of the future market acceptance, accident risk, risk towards the consumer's daily routines due to long charging times, expansion of the charging stations, and the fear of a long purchase process (Bessenbach & Wallrapp, 2013).

**Table 2.5: Risk Barriers to EV Adoption**

	<b>Norway</b>	<b>%</b>	<b>Sweden</b>	<b>%</b>	<b>Denmark</b>	<b>%</b>	<b>Germany</b>	<b>%</b>
1	Nearby charging station	93	Nearby charging station	87	Expansion	94	Nearby charging station	87
2	Expansion	86	Expansion	80	Nearby charging station	88	Expansion	85
3	Battery capacity	71	Purchase price	53	Daily routines	69	Daily routines	67
4	Daily routines	64	Battery capacity	47	Battery capacity	63	Purchase price	62
5	Purchase price	50	Accident risk	33	Market acceptance	49	Battery capacity	59
6	Market acceptance	36	Daily routines	33	Purchase price	44	Market acceptance	56
7			Market acceptance	33	Accident risk	38	Accident risk	51
8							Buying process	51

Source: Bessenbach & Wallrapp (2013)

The surprising result was that the battery capacity did not feature as the perceived top risk barrier for most countries; however, the Norwegians rated the risk towards battery performance as high due to Norway's cold climate which may impact battery performance. Countries such as Denmark receive high purchase price subsidies and so rank purchase price development risk low.

Table 2.6 shows the consumer valuation of buying incentives including dedicated parking space, city toll exemption, free parking, bus lane, and reduction in insurance

cost, free charging, car tax exemption, purchase price subsidies and carbon dioxide regulations. The market preferences for the Danes and Germans appear to be aligned.

**Table 2.6: Consumer Valuation of Buying Incentives**

	<b>Norway</b>	<b>%</b>	<b>Sweden</b>	<b>%</b>	<b>Denmark</b>	<b>%</b>	<b>Germany</b>	<b>%</b>
1	Parking space	75	Purchase price	70	Insurance	72	Free charging	70
2	City toll	75	Car tax	70	Car tax	68	Car tax	63
3	Free parking	72	Free charging	69	Free charging	68	Insurance	55
4	Bus lane	71	Insurance	65	Purchase price	56	Parking space	52
5	Insurance	68	CO <sub>2</sub> registration	65	Parking space	48	Purchase price	45
6	Free charging	34	City toll	48	Free parking	44	Free parking	44
7	Car tax	48	Free parking	43	CO <sub>2</sub> registration	44	CO <sub>2</sub> registration	44
8	Purchase price	46	Parking space	43	City toll	36	City toll	43
9	CO <sub>2</sub> registration	36	Bus lane	26	Bus lane	28	Bus lane	31

Source: Bessenbach & Wallrapp (2013)

The study highlights that the risks and drivers for EV adoption are prevalent at various intensities and rates in different countries. This is very important since South Africa cannot be assumed to have the same risks and prioritisation order as those identified in any other countries.

Results from customer surveys completed during the Nissan-Eskom BEV pilot study, indicated that range anxiety, the EV price and short driving range were the biggest disadvantages, with an average range of 272 km perceived as being ideal with an average price of R272,000 (Langley, 2016).

#### **2.4.6 EV Projects in South Africa**

There have been many EV projects and demonstrations in South Africa, including the following:



#### 2.4.6.1 *Department of Transport: Green Transport Strategy and the Roads Policy*

This strategy entails a number of EV related actions, which could enable the market penetration of EVs, with an underlying proviso that charging is through renewable resources (DOT, 2016):

- Lower or no import taxes on EVs, including the declassification of EVs as luxury goods
- Trade incentives for EV manufacturers to produce and sell affordable EVs in South Africa, for the local and export markets.
- Work with research institutes to manufacture EV batteries at reduced cost.
- Work with Government departments and the automobile industry to set annual targets for EV uptake and hybrid EVs in the government fleet.

#### 2.4.6.2 *The United Nations Industrial Development Organization (UNIDO's) Low Carbon Transport South Africa Project (LCT SA)*

It has been noted that vehicle congestion may have a negative impact on the GDP, resulting in as much as 1-3% drop in GDP (LCTSA, 2017). Additionally, impacts on health (pollution, noise, accidents) were also identified. ICE vehicles were identified as contribution to the toxicity and environmental damage due to exhaust gasses released, resulting in amended specifications for vehicles and fuels, ultimately leading to higher vehicle costs. This has resulted in a drive to find and implement alternatives to fossil fuels (a finite source) and find ways to ensure safe, reliable and affordable transport.

#### 2.4.6.3 *South African National Energy Development Institute's (SANEDI's) Cleaner Mobility Programme*

SANEDI's objective "to accelerate transformation to a less energy and carbon intensive economy" has resulted in various research and development drives, one of which includes partnering with various organisations to support the drive for electric vehicles (SANEDI, 2016). The programme identifies the fact that this drive could only be made possible by ensuring greater affordability, information sharing, charging infrastructure roll-out and local component manufacturing.

#### 2.4.6.4 *The CSIR Energy Fleet*

The CSIR-based Gridcars engaged in developing a 3-wheel two seater passenger car with an 80 km driving range, as well as light EV which could be used for waste removal and local goods transport (SFSA, 2017). Other initiatives include assessing the

technology and driver experience of four BMW i3's and six Nissans by employees to understand EV operating costs, battery life and performance and the integration of the cars into their Energy Autonomus Campus to balance supply and demand.

#### 2.4.6.5 uYilo eMobility Programme

This is a collaborative project focused on supporting research (funding, engineering services and coordination) related to electric vehicle technology. This programme was launched on the 13<sup>th</sup> March 2013 by the Technology Innovation Agency (TIA). The objectives of this drive is to support the country move towards renewable energy generation into smart grids, charging networks, local standardisation, battery technology, electric drive train components and smart connectivity. The uYilo programme together with SANEDI provided an EV to demonstrate application in safari mobility operations (Figure 2.8) at the Shamwari Game Reserve. The EV used a solar charging station with battery storage to become fully green and hopes to support similar drives in the ecotourism industry (Shamwari Game Reserve, 2015).



**Figure 2.8: Electric Vehicle for Safari Mobility**

Source: uYilo (2017)

#### 2.4.6.6 Transport Nationally Appropriate Mitigation Actions (NAMA) project

The TRANSfer project run by Deutsche Gesellschaft für Internationale Zusammenarbeit (GIZ) is funded by the International Climate Initiative of the German Ministry for the Environment, nature Conservation, Building and Nuclear Safety (MBUM) to support developing countries to construct and execute climate change mitigation strategies in the transport sector (NAMA, 2010). Partner countries include South Africa, Indonesia, Peru and Colombia.

#### *2.4.6.7 eBike Sharing Schemes (Growthpoint, City of Tshwane pilot, University of Stellenbosch, Nelson Mandela Metropolitan University (NMMU))*

Ten e-Bikes were launched in February 2016 as part of a green transport pilot project. The e-Bikes have customized docking stations on the Nelson Mandela Metropolitan University campus where charging is conducted through rooftop solar panels (EXpress, 2016). Figure 2.9 shows the solar powered e-Bikes at NMMU (NMMU, 2016).



**Figure 2.9: eBikes, NMMU**

Source: NMMU (2016)

#### *2.4.6.8 EV Charging infrastructure roll outs*

Various initiatives have started focussing on EV charging infrastructure in South Africa. In May 2015, BMW and Nissan signed a memorandum of agreement to work together to build a national grid of EV and PHEV charging stations for both makes of cars. In the City of Tshwane, there are already 32 charging stations, with the City hosting the Green Mile event which celebrated the EV infrastructure in August 2017. Two solar charging stations were launched with the publicly available one located at the Lyttleton Municipal Offices (Figure 2.10) (Capeetc, 2015). The City of Tshwane was chosen for the charging stations as part of the Cities Green Transport Programme funded by the Green Fund in 2015.



**Figure 2.10: Solar-powered Electric Car Charger – City of Cape Town**

Source: Capeetc (2015)

#### *2.4.6.9 EV Public transport developments*

MellowCabs is an initiative run by Neil du Preez, looking at building mini-cabs for efficient urban transport, operating on low costs (using recycled materials) and energy efficiency (Amberber, 2014). Some of the specifications of the MellowCab include: regenerative braking (recovered kinetic energy for electricity conversion); mobile phone charging (charging on board the vehicles); and hydrogen fuel cells. MellowCabs have a limited urban radius of 3-4 km and can provide about 110km of transport before requiring recharging. The vehicles are manufactured in South Africa and sold throughout the world.

Besides the MelloCab tuk-tuks, South Africa has been looking at suspended Podcars (Futran System) for transporting people and goods in and out of mines; hauling coal cost effectively or being used as a conveyor belt alternative. The application of the system will enable automated units to operate using job cards as opposed to centralised control. Testing of the system took place outside Brits, in South Africa. The first market application of Futran has been for mine haulage (Figure 2.11) (Luw, 2016).



**Figure 2.11: Mine haulage testing of Futran**

Source: Louw (2016)

#### *2.4.6.10 Eskom eMobility Programme*

Post the collaborative Nissan BEV pilot study conducted between Nissan and Eskom SOC, the company has since proceeded to business model to consider the strategic impacts of electric mobility in the country. The project will also aim at looking at the most innovative, cost-effective and customer-focussed solutions in establishing Eskom SOC as the primary energy provider for the emerging eMobility market (Chapman, 2018).

#### **2.4.7 Technology Roadmaps for EVs**

Several roadmaps have been compiled for various cities and/countries throughout the world. In this section, summaries from some of these roadmaps have been listed. Various studies, such as that undertaken by Chan et al. (2009), attempt to map the future path for electric vehicles on different levels, namely: infrastructure, supply, awareness and acceptance, and so forth. A study was compiled by Element Energy, Ecolane and Dr Jillian Anable, who were commissioned by Committee on Climate Change to assess the market supply outlook and the factors influencing vehicle purchase (Element Energy Limited, 2013). The study shows high uptake targets for 2020 and 2030, which correspond to 0.27 million and 2.1 million EV annual sales respectively. This indicates that there would be 60% market share in 2030 which would potentially be achieved with a technology split of 35% PHEVs and 25% BEVs and a cumulative fleet of 13.6 million electric cars and vans on UK roads by 2030.



Studies conducted by the International Energy Agency (IEA) indicate that there could be as many as 20 million EVs on the roads (globally) by 2020 (IEA, 2013). The key findings of the IEA roadmap (IEA, 2011):

- Industry and governments should reach a combined EV/PHEV sale share of at least 50% of the low drive vehicles (LDV) by 2050, globally.
- EV/PEV sales are suggested to improve oil security, reduce urban pollution and noise.
- Policy in support of cost reduction and recharging infrastructure is required.
- Consumer behaviour in terms of willingness to change to EVs and travel behaviour has to be improved.
- Performance improvements for driving range and batteries, together with research and development to bring battery and material costs down.
- Further research and development on smart grids and vehicle grid interfacing would also be needed.
- International collaboration on research programmes, codes and standards, vehicle alignments and the roll out of infrastructure.

The key findings of the Electric Vehicles Roadmap compiled by the Sustainable Energy Authority of Ireland (for the Irish passenger car market) are as follows (SEAI, 2017):

- By 2020 there would be 10% EV substitution of the passenger car market and 60% by 2050.
- Transport fossil fuel imports reduce by 50% in 2050 compared to 2011, an equivalent of 800 000 tonnes of oil per annum.
- Renewable energy increases by 50% in the passenger vehicle segment by 2050.
- Based on battery cost reduction, EVs may provide a more cost effective 10 year ownership than ICE vehicles from 2019 until 2025, excluding other financial incentives.
- Gross electricity consumption would grow by 14% with EV penetration. With a 5 hour night charging regime, 2.7 GW of electricity would be required to supply 1.7 million EVs, hence the importance of load management.

A roadmap was compiled to look at the EV landscape and developments in the EV markets with a specific focus on passenger transport for India, using bottom up MARKAL modelling.

The key findings are as follows (Shukla, Dhar, Pathak, & Bhaskar, 2015):

- There is an expectation for battery costs to decline and increase energy density.
- Although electric two and four wheel vehicles are available, costs and charging times are high.
- Two wheelers will remain the transport choice in 2035 while the market share for four wheelers will increase significantly, while within city centres, two wheelers with low costs are suitable even with limited driving range.
- High EV market penetration will depend on demand side incentives such as lowering tax, as well as improved infrastructure and will not require significant capacity additions within the electricity sector or a change in electricity supply mix.
- EVs provide energy security with a move away from oil dependence and significant by 2025 onwards, and may offer distributed storage in urban energy systems and better support the integration of renewables such as wind and solar.
- Air quality benefits are realized in the short-term with EVs, while by 2035 emissions halve.

The South African Department of Trade and Industry compiled an electrical vehicle industry roadmap to support an electric car environment and the development and production of electric vehicles and their component parts (DTI, 2012). The vision for electric mobility was summarised as:

*“To promote the manufacture and use of electric vehicles in South Africa by 2020 for the domestic and export markets, thereby establishing a well-developed emission friendly vehicle sector leading to increased investments, job opportunities and human capacity building.”*

The national policy developments, which influenced the development of this roadmap include:

- a) **The Long Term Mitigation Scenario (National Treasury)** (DEAT Scenario Building Team, 2007): This had been established to provide a firm South African base for the climate negotiations post 2012. EVs were identified as a mitigation option with a coal based electricity grid but much more favourable if it was renewables based.
- b) **The National Climate Change Response (NCCR) Green Paper 2010 (Dept. of Environmental Affairs)** (DEA, 2010): This states that the government recognises climate change as a priority for meeting South Africa’s development goals and the

Millennium Development Goals. EVs and hybrids were recognised as cleaner technologies for the transport sector.

- c) **National Transport Master Plan (NATMAP) (Department of Transport)** (Morapedi & Makhari, 2018): This Plan has been framed around 6 guiding principles linked to sustainable development such as security of natural resources while ensuring social and economic development; reduction of poverty; sustainable human settlements without encouraging urban sprawl; protection of natural resources, human health and safety; energy security, diversification and efficiency; compliance with international agreements on greenhouse gas emissions.

The roadmap also looked at localisation possibilities and found that due to South Africa's mineral resources, the EV battery cathode, anode and electrolytes offer opportunities. Other components which were identified for possible localisation based on similar components being manufactured locally in South Africa are included in Table 2.7.

**Table 2.7: Possible Localisation of EV Components**

<b>EV Components</b>	<b>Similar Components Manufactured In South Africa</b>
<b>DC/DC Convertor</b>	Electronics
<b>Motor controller</b>	Motors, Electronics,
<b>Traction motor</b>	Motors, Differentials, Drive shafts
<b>Cooling system for motor and controller</b>	Cooling module assemblies, Thermostats
<b>Transmission/gearbox</b>	Gearboxes
<b>Brake controller to blend regenerative and conventional brakes</b>	Brakes , Handbrakes
<b>Electric power steering</b>	Steering
<b>Electric power brakes</b>	Brakes
<b>EV heating system</b>	Heat exchangers , casings, induction heaters
<b>Electric air conditioning system</b>	Air conditioning, electronics, cooling module assemblies
<b>EV heating system</b>	Heat exchangers, HVAC Systems

Source: DTI (2012)

Although some of the existing machinery can be slightly modified and used for EV component manufacture, training programs would be required to with a focus on EV



technologies. The roadmap also highlighted the need for standards for EVs which need to consider electric hazards e.g. protection against shock, mechanical hazards e.g. safety belts, and special hazards e.g. battery location. The need for public awareness was also highlighted, specifically with respect to emissions reductions, besides the need for research and development initiatives. Part of the incentives for going for greener transport options for consumers included:

- a proposal for emission control regulation and taxes on non-EV sales;
- standardisation of domestic charging infrastructure;
- Planning and development in the space of public transport, urbanization, smart cities, enabling infrastructure, mobility and integrated planning, and economic development;
- Reducing licence fees for EVs and Tax rebates for owners of EVs;
- Financial subsidies (Some governments e.g. Canada and the UK have proposed subsidies from R20 000 to R70 000 per vehicle for EV purchases).

#### **2.4.8 BEV Forecasts in South Africa**

Urban Foresight explains the Gartner Hype Cycle to represent what the EV forecast may be like (Figure 2.12) (Beeton, 2015). The Hype Cycle elements relevant to EVs may have the following trend:

- a) *Technology Trigger*: at around 2007/2008, it is assumed that EV prototypes and proof-of-concept demonstrations emerged but no commercialised products.
- b) *Peak of Inflated Expectations*: in 2011, early adopters implemented the EV technology
- c) *Trough of Disillusionment*: this was thought to have occurred in 2014 when aspects linked to EVs caused some disappointment; this could have included high retail costs, low driving range etc.
- d) *Slope of Enlightenment*: After 2014, the EV technology is assumed to have taken this trajectory when the potential is better understood and many companies begin implementation of the technology.
- e) *Plateau of Productivity*: this is where EV technology is assumed to be better understood and various initiatives supporting policy development take place.

Frost & Sullivan proposed three global scenarios of 1.2 million, 3.8 million or 2.7 million EV unit sales by 2020 (Kumar, Paton, & Muller, 2014). They forecasted that BEVs would constitute 16% in North America, 14% in Europe, 24% in China, 25% in South Korea, and 13% in Japan by year 2015 (IEA, 2017). Countries like Brazil expect a growth of 10 000 BEVs by 2023.

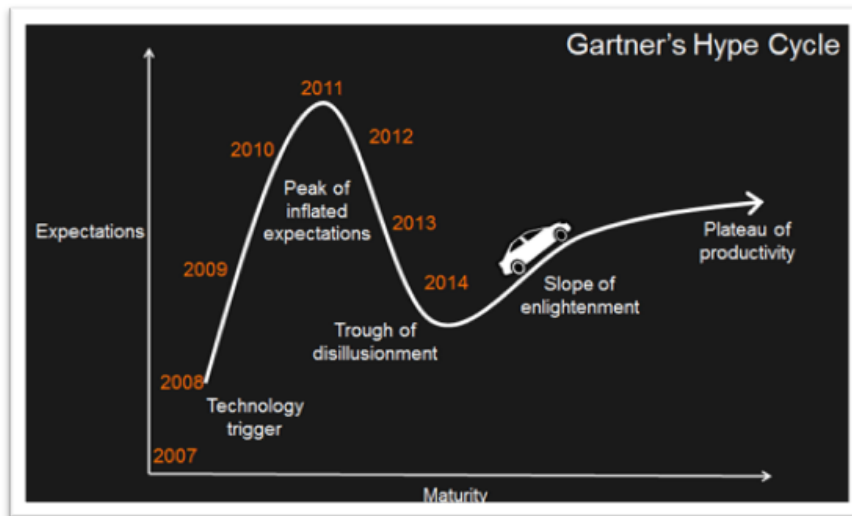

**Figure 2.12: Gartner Hype Cycle with an EV Forecast**

Source: Beeton (2015)

In South Africa, analytics group Lightstone indicates that 375 EVs have been sold in South Africa from 2013 until the end of 2017, not even 0.1% of the annual passenger vehicle sales (Knight & Thompson, 2018). Knight & Thompson (2018) used Norway's EV growth data to determine possible EV growth in South Africa, and indicates that within seven to ten years, South Africa could have around 200 000 passenger EVs on the road, with electrical energy consumption around 1,159 GWh of electricity per year for the fleet (assuming a Nissan Leaf equivalent driving 2,000 km per month at 21.25 kWh/100km and with 15% charging losses). Estimations by motor vehicle manufacturers, such as BMW, indicate success if sales included about 200 EVs annually from 2015 until 2020 (Kumar, Paton, & Muller, 2014).

Grant (2014) provides a summary and presents an adapted list using data from the International Energy Agency for BEVs and PHEVs targets set by various countries (refer to Table 2.8). Chile proposed a target of 70,000 PH/BEVs by 2020 (Ministry of Transport Chile, 2012) and Israel is looking at 40,000 between 2012 and 2020. KPMG indicates a conservative EV forecast of less than 15% of the annual global new vehicle registrations by 2025 (KPMG International, 2012).

**Table 2.8: PH/BEV numbers and targets with required annual growth rates**

Country	2012	2020 Target	Annual Growth to reach Target (%)
United States	71,174	2,488,320	56
Japan	44,727	800,000	43
France	20,000	2,000,000	78
China	11,573	5,000,000	114
United Kingdom	8,183	1,550,000	93
Netherlands	6,750	200,000	53
Germany	5,555	1,000,000	91
Denmark	1,388	50,000	57
Sweden	1,285	600,000	116
Spain	787	2,500,000	174

Source: Grant (2014)

South Africa's Electric Vehicle Industry Roadmap established an intent to develop policies to ensure that 5% of the total annual fleet by the State and State Owned Enterprises should comprise of electric vehicles with an annual 5% increase from 2015 until 2020 (DOT, 2013). Of the 4,273 passenger vehicles purchased by the S.A Government in 2016, 10 were electric vehicles (Bubear, 2017). A CSIR study of EV forecasts indicates 3 possible scenarios, a low adoption outlook which forecasts 270,000 by 2050, a medium adoption scenario of 2.9 million EVs by 2050 and a high scenario of 5 million EVs by 2050 (Bischof-Niemz, et al., 2017).

An increase in luxury goods purchases appears to correlate positively with an improvement in economic conditions within a country (Reyneke, Sorokáčová, & Pitt, 2012). To this effect, one indicator of BEV (a luxury good) affordability could be the GDP parametric, and according to Jordaan (2016) this means a possible target of 100,000 BEVs by 2020 based on a 0.5% South African percentage of the world's GDP. Jordaan (2016) also uses a possible metric of the South African percentage of the global value of passenger motor vehicles annually registered, which he approximates to 0.8% which forecasts a value of 160,000 EVs by 2020. This is similar to the 2020 EV forecast by Bloomberg New Energy Finance (Dane, 2017), where the EV penetration rate was estimated to reach ~0.8% of new car sales by 2020. Bloomberg latest report, Electric Vehicle Outlook 2018 (Morsy, 2018) forecasts 55% of new car sales being electric globally, with 11 million being projected for 2025 and 30 million in 2030.

### 2.4.9 Environmental Aspects including Carbon Emissions

The harmful impact of carbon emissions from internal combustion engines has encouraged the adoption of electric vehicles, but unless low carbon technologies are used to supply electricity to these vehicles, the carbon reduction potential is questionable (Wilson, 2013). The report by Wilson (2013) concludes that electric cars carbon emissions are four times greater in places with coal fired power station electricity generation, than for those countries using low carbon technologies like hydroelectric power.

Research conducted by the University of Witwatersrand (Liu, Hildebrandt, & Glasser, 2012) indicate that due to the low quality coal and inadequate emissions reduction technologies at the South African power stations, introducing electric vehicles would not assist in reducing emissions right up to 2030; in fact, it may even exacerbate the situation. The one advantage though, may be the zero emissions at the end user, which implies improved air quality in urban areas (Bloch, 2012).

Other environmental aspects to consider with electric vehicles would include the manufacturing process. Research indicates that the production of lithium-ion batteries is energy intensive and may result in far more emissions over the life of the vehicle compared to emissions from diesel ICEVs (Fischer, 2017), unless EVs are charged by renewable sources and can be driven for 125,000 km to break even with a diesel car, assuming an average mileage of 13,500 km (Eckart, 2017). The impact may stem from the mining of the metals required for the battery and vehicles (Whitman, 2016). Most of the lithium is extracted from brines beneath the South American deserts; however, a portion comes from crushing rock in Australia and processing the mineral in China (very energy intensive) (Sanderson, 2017). Risks for the increased demand in lithium for batteries due to the increase in EVs is that smaller mining competitors may emerge who do not adhere to the environmental codes, and possibly causing deforestation, polluted rivers or contaminated soil. Additionally, the nickel and cobalt production of the battery cathode also contributes to the energy footprint. The Fraunhofer Institute for Building Physics estimates that each kilowatt of battery capacity involves 125 kilograms of CO<sub>2</sub> emissions i.e. for a 22 kWh battery for a BMW i3, this is about 3 tons of CO<sub>2</sub> (Held, n.d.). A study by the IVL Swedish Environmental Research Institute indicates battery production creating 150 to 200 kilograms per kWh and current technology resulting in 350-650 Megajoule of energy per kWh (Fischer & Keating, 2017).

Figure 2.13 is based on a study by *Shrink That Footprint*, a research group focussed on climate change related issues (Wilson, 2013). The result are for about 20 countries

where calculations were based on national average grid emissions linked to charging EVs, the manufacturing process as well as the fuel consumption over the vehicle lifetime. The findings indicate that the top emitting countries actually use a coal fired base, hence in countries such as South Africa, it was concluded that EVs will have limited climate benefit (Wilson, 2013).

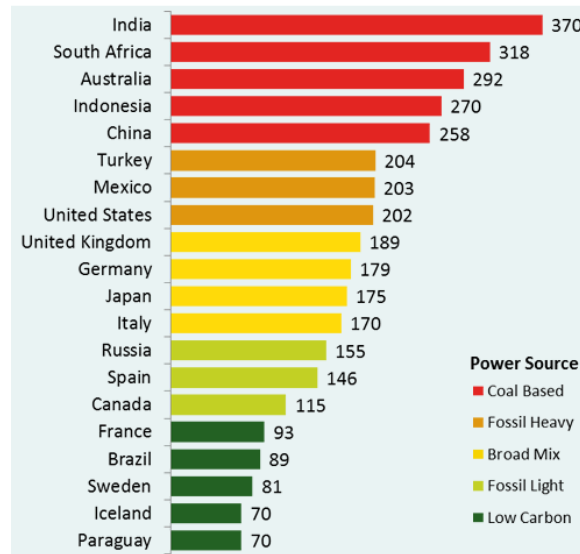

**Figure 2.13: Emissions for Electric Vehicles (Grams CO<sub>2</sub>e/km)**

Source: Wilson (2013)

The South Africa Minister of Environmental Affairs signed a pledge to support the Paris Agreement on Climate Change commitments in April 2016 (DEA, 2016). The Paris Agreement includes an average emissions reduction target of 95 grams of CO<sub>2</sub> per kilometre for all new cars by 2021, noting the 2015 target of 18% below the 2007 fleet average of 158.7 grams of CO<sub>2</sub> per kilometre (European Commission, 2017). The 2015 target corresponds to 5.6 litres per 100 km for a petrol vehicle or 4.9 litres per 100 km for a diesel vehicle. The 2021 target would require 4.1 litres per 100 km for a petrol vehicle or 3.6 litres per 100 km for a diesel vehicle, which is an expected 27% improvement in fuel efficiency from 2015 to 2021.

## 2.5 South Africa's Provinces

South Africa has nine provinces: the Eastern Cape province, the Free State province, Gauteng province, KwaZulu Natal province, Limpopo province, Mpumalanga province, North West province, the Northern Cape province and the Western Cape province. Figure 2.14 illustrates the provinces with their respective capitals.



**Figure 2.14: Map of the South African Provinces**

Source: ShowMe SA (2008)

For this study, it was important to understand the regional differences in GDP, average disposable income, population, economic activity drivers, electricity demand and the ICEV profiles; so that the affordability of BEVs could be established per decile per province to plan for changes in electricity demand due to different BEV market penetrations and to plan for charging infrastructure. A study on a provincial level also supports an understanding of how meaningful the impact of green vehicle technologies will be in contributing to climate change mitigation mechanisms.

### 2.5.1 GDP and Population

The South African Institute of Race Relations (SAIRR) stated that the proportion of people living in urban areas in South Africa has increased from 52% in 1990 to 62% in 2011, due to concentrated economic activity in these areas (Turok, 2012). With urbanisation, comes an increase in population (SAIRR, 2013). Studies using data for metropolitan areas in the United States from 1970 until 1990 indicate that the per capita income increases directly with population size (Jones & Kone, 1996). Studies by Chen et al. indicate that although there is a definite correlation between urbanization levels and GDP per capita; the rate of urbanization does not reflect the rate of economic growth (Chen, Zhang, Liu, & Zhang, 2014). Data from the 2012 StatsSA

survey indicates that Gauteng contributed 34.95% to the country's overall GDP, while the province with the smallest contribution is the Northern Cape at 2.19% (Table 2.9).

**Table 2.9: GDP and Population per Province**

Province	2016 GDP (% Contribution)	2017 Population Mid-Year Estimates
Eastern Cape	7.59	6,498,700
Free State	5.2	2,866,700
Gauteng	34.95	14,278,700
KwaZulu Natal	15.97	11,074,800
Limpopo	7.14	5,778,400
Mpumalanga	7.20	4,444,200
Northern Cape	2.19	1,214,000
North West	5.88	3,856,200
Western Cape	13.88	6,510,300

Source: Statistics South Africa (2018)

South Africa is ranked as 37<sup>th</sup> when it comes to GDP per capita compared to other countries like Norway, which is the 26<sup>th</sup> largest economy in the world, but with the highest GDP per capita. Figure 2.15 shows the time series trend of the provinces and the national South African GDP per capita based on constant 2010<sup>5</sup> prices (1993 until 2016) (Stats SA, 2018). There is a steady increase in the average GDP per capita of the country, with Gauteng province having the highest GDP per capita and the Eastern Cape province the lowest.

On a national level, based on 2016 GDP data, the largest contributor to the South African economy is the Finance, Real Estate and Business Services industry (20%), with the government sector making up around 15% and then the Trade (wholesale, retail and motor trade) and accommodation industry coming in in third place with 13.9% (South African MI, 2017). Riley (2015) indicates that the South African economy is very dependent on the mining sector which has been on a declining trend, besides a decreasing share of industrial output and jobs as a part of the total economic wealth.

For the South Africa economy to expand and make a notable change in poverty levels, projections indicate an annual GDP growth rate of 5% (2% due to population growth, a

---

<sup>5</sup> Base year 2010 aligns with the national and European changes implemented in February 2013, which re-referenced short term statistics and time series data from base year 2005 to 2010 (Botes, 2014) (Van de Ven, 2015).



further 0.5-1% to maintain employment levels, another 2% to unemployment by half a million jobs per year) (Van Zyl, 2016).

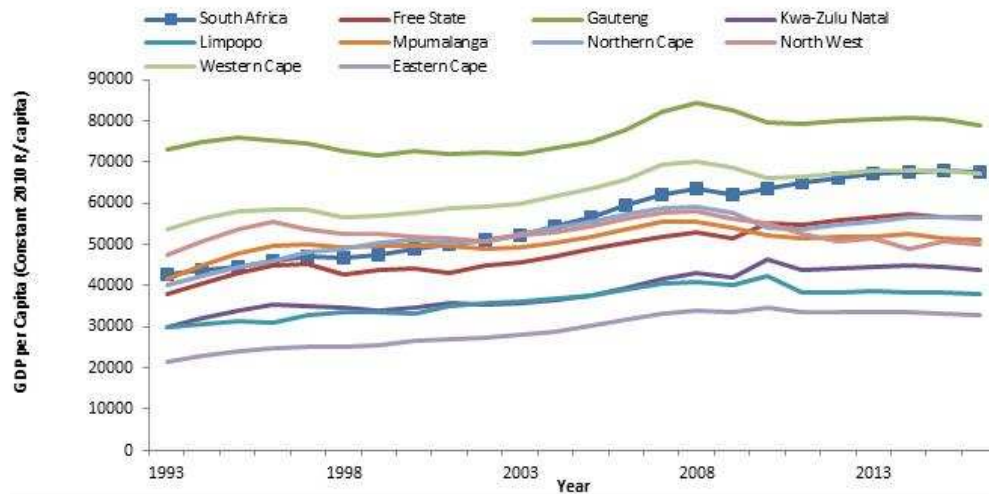

**Figure 2.15: GDP per Capita for South Africa and the Provinces**

Source: Adapted from Population and GDP data from StatsSA (2018)

S&P Global Ratings has indicated a growth forecast for South Africa of 2% for 2018, from 1% previously, and expects the economy to expand by 2.1% in 2019 (Creamer, 2018). South Africa thus may have to relook at global competitiveness, management of political instability (which tends to downgrade the country's investment-grade credit rating and decrease investor confidence), and manage macroeconomic instability.

The provincial GDP data was necessary for causally and mathematically linking residential consumption and income distribution on a regional level, based on previous work by Pillay et al. (2014). This was the basis for the structural expansion to include the disposable income per province and the affordability of BEVs.

### 2.5.2 Income Inequality

Income inequality refers to the extent to which income is distributed in an uneven manner amongst people in a country. There are various methods that can be used to calculate and understand these inequalities include the Atkinson index, the coefficient of variation, decile ratios, generalised entropy (GE) index, Kakwani progressivity index, the proportion of total income earned, the Robin Hood index, and the Sen poverty measure (De Maio, 2007). Another possible mathematical representation of income distribution is through the Lorenz curve (developed by Max O Lorenz in 1905), which plots the cumulative percentage of total income received against the cumulative



number of individuals/households; starting with the poorest individual or household (Lorenz, 1905; Gastwirth, 1971). The Gini index (also known as the Gini coefficient) was introduced by statistician Corrado Gini (1912) to highlight income inequalities, and measures the extent to which the distribution of income among individuals or households within a country diverges from a perfectly equal distribution (Farris, 2010; Sun, 2007).

The Gini coefficient is mathematically expressed as follows for population with increasing income ordered so that for: 1, 2, 3... n, the income is  $x_1, x_2, x_3... x_n$  with  $x_1 < x_2 < x_3... < x_n$  (Tziafetas, 1989):

$$G = \frac{\sum_i^n (2i - n - 1) (x_i)}{n \sum_i^n x_i}$$

Where:  $G$  is the Gini coefficient;  $n$  = number of individuals (households) in a group; and  $x_i$  = income (expenditure) of  $i^{\text{th}}$  individual (household).

In an equal society, 10% of the population would receive 10% of the income, 20% of the population would receive 20% of the income, and so forth. In such a society the Gini coefficient would be zero. The Gini coefficient can vary between zero and the highest possible value of 1. When the Gini coefficient lies at 1, it means that 1% of the population receives 100% of the income (Benson, 1970).

South Africa has one of the highest Gini coefficients in the world; 0.63 for 2011 (Bosch, Rossouw, Claassens, & Du Plessis, 2010), but it is now estimated to be nearly 0.7 (Høj & Lewis, 2015).

The historical provincial income distribution (as represented by the Gini coefficient) is shown in Table 2.10. It can be seen that there is very little variance between the provinces; however, since this dynamic will be included in a simulator, it will provide future scenarios to determine what the impact of significant provincial variations will have on the overall electricity growth. This could also be compared for sensitivity runs of the effect of GDP versus the Gini coefficient impact on residential electricity consumption.

**Table 2.10: Gini coefficient per Province**

Province	1996	1999	2004	2009	2014
Eastern Cape	0.60	0.64	0.66	0.60	0.62
Free State	0.58	0.63	0.65	0.59	0.61
Gauteng	0.59	0.64	0.67	0.60	0.65
KwaZulu Natal	0.60	0.64	0.66	0.59	0.63
Limpopo	0.59	0.63	0.64	0.59	0.60
Mpumalanga	0.59	0.63	0.65	0.61	0.61
Northern Cape	0.58	0.62	0.64	0.61	0.61
North West	0.57	0.61	0.64	0.60	0.60
Western Cape	0.56	0.60	0.62	0.61	0.61

Source: IHS Global Insight Rex (2015)

Historically, the link between income distribution and electricity demand has been modelled using an econometric methodology and Amusa et al. (2009) indicate that a 1% increase in income results in a 1.67% increase in the total demand for electricity in South Africa (essentially a price elasticity of demand). The International Energy Agency indicates that there is a strong correlation between electricity consumption and wealth, as a measure of net worth (IEA, 2002). It has been found that larger, wealthier societies consume more energy, generally derived from fossil fuels (Tainter, 2011).

In 2014, a system dynamics approach was used to determine the causal mathematical relationship between income distribution (specifically the Gini coefficient) and electricity demand (Pillay, 2014). Findings indicated that for a GDP growth rate of 2%, until year 2035, a Gini coefficient of 0.5 implies a 3.14% increase in residential electricity demand, while a Gini coefficient of 0.4, indicates a 4.73% increase in residential electricity demand. The causality and quantitative nature of the approach followed by Pillay (2014) will be further resolved on a provincial level, since more income equality may potentially result in more electric vehicle sales based on greater affordability due to higher disposable incomes within households.

Studies led by World Bank program leaders Sebastien Dessus and senior economist Marek Hanusch, premise that the income distribution in South Africa could improve with labour market developments, continued investment in education for the poor, and investing GDP into transport and social housing (Creamer, 2018), possibly even improving the Gini coefficient from 0.628 in 2017 to 0.595 by 2030 (World Bank, 2018).

### 2.5.3 Provincial Distribution of Vehicles

To the author's best knowledge, there were no peer reviewed journal publications were identified during the extensive literature review process on the causal relationship between disposable income and vehicle affordability on a decile level within the provinces in South Africa. However, statistical data was available showing the national average monthly income per proportion of households with a motor vehicle (Table 2.11) (Van Heerden, 2016) and the percentage ownership of motor vehicles by households (Table 2.12). It was also notable that 29.9% of household members in the Western Cape used cars as the primary mode of transport, followed by 25% in Gauteng; while the lowest users of motor vehicles were in Limpopo province (7.7%) and in the Eastern Cape (8.6%) (DOT, 2005). Data on the number of ICEVs per income decile (nationally) as transport vehicle purchase expenditure fractions (Table 2.13) was obtained from StatsSA (Ruch, 2017).

**Table 2.11: Monthly Income and Proportion of Households with ICEVs**

<i>Monthly Income Category</i>	<i>Proportion of Households with a Motor Vehicle</i>
Up to R799	2.8%
R800-R1 399	4.5%
R1 400-R2 499	2.9%
R2 500-R4 999	9.3%
R5 000-R7 999	20.7%
R8 000-R10 999	44.7%
R11 000-R19 999	75.2%
R20 000	145.3%

Source: Van Heerden (2016); IRR, Eighty20, Xtract based on AMPS (2014 )

**Table 2.12: Households with a Motor Vehicle per Province**

<b>Province</b>	<b>Households with a motor vehicle</b>	<b>Households in province</b>	<b>Proportion of households with a motor vehicle</b>
Eastern Cape	458 711	1 820 696	25.2%
Free State	317 690	825 796	38.5%
Gauteng	2 550 339	4 137 938	61.6%
KwaZulu Natal	944 475	2 600 871	36.3%
Limpopo	296 658	1 350 036	21.9%
Mpumalanga	451 007	1 102 035	40.9%
North West	347 395	977 368	35.5%
Northern Cape	133 190	308 277	43.2%
Western Cape	974 202	1 837 623	53.0%
<b>South Africa</b>	<b>6 473 666</b>	<b>14 960 639</b>	<b>43.3%</b>

Source: AMPS 2014 Individual January–December 2014 data

**Table 2.13: Expenditure on Transport and Vehicle Purchases per decile**

<i>Decile</i>	<i>1</i>	<i>2</i>	<i>3</i>	<i>4</i>	<i>5</i>	<i>6</i>	<i>7</i>	<i>8</i>	<i>9</i>	<i>10</i>
% Transport	11.8	10.7	10.7	11.3	11.1	12	12.9	13.8	15.1	19.6
% Vehicle Purchase	0	0	0	0.1	0.1	0.3	0.9	1.8	3.7	12

Source: Ruch (2017)

Per capita vehicle ownership was identified as being low in South Africa, in a study of Mervin et al. (2012), with the Gauteng province having had a motorisation level in 2010 of 314 vehicles per 1000 people, followed by the Western Cape with 281 vehicles per 1000 people, and the lowest in Limpopo province with vehicles per 1000 people. The percentage of motor vehicles per province per age category is shown in Table 2.14 and the provincial average age of motor cars is in Table 2.15 (Stats SA, 2016).

**Table 2.14: Percent of Motor Cars at Various Ages per Province**

		<b>Percentage of Motor Cars at Various Ages per Province (%)</b>							
<b>Years</b>	Gauteng	KwaZulu Natal	Western Cape	Eastern Cape	Free State	Mpumalanga	North West	Limpopo	Northern Cape
>10	43.66	47.73	49.23	51.67	57.81	51.91	56.11	54.67	57.64
>15	27.16	29.25	30.34	31.84	38.49	33.69	36.6	36.74	38.77
>20	14.45	13.65	15.13	15.77	22.82	18.64	20.82	20.72	23.45
>25	5.33	4.92	5.72	5.72	9.27	6.71	7.91	7.21	9.46
>30	2.34	2.54	2.83	2.75	4.1	2.73	3.14	2.75	4.06
>35	0.78	1.26	1.07	1.08	1.33	0.82	0.94	0.78	1.28
>40	0.32	0.9	0.49	0.53	0.57	0.35	0.39	0.33	0.57

Source: Stats SA (2016)

**Table 2.15: Average Age of Motor Vehicles per Province**

<b>Province</b>	<b>Average Age of Motor Vehicle (Years)</b>
Eastern Cape	10
Free State	12
Gauteng	9
KwaZulu Natal	10
Limpopo	11
Mpumalanga	11
North West	11
Northern Cape	12
Western Cape	10

Source: Stats SA (2016)

The CSIR (Bischof-Niemz, et al., 2017) indicates that their low adoption scenario for electric vehicles was based on the vehicle population data and spatial density through the different provinces. The distribution of EVs and the expected electrical energy consumption (average annual distance of 18,500 km) by year 2030, for the low adoption scenario is shown in Table 2.16, for the medium adoption scenario in shown in Table 2.17 and for the high adoption scenario is shown in Table 2.18.

**Table 2.16: BEV numbers and Electrical Energy Demand per Province by 2030 (Low Adoption Scenario)**

<i>Province</i>	<i>Number of EVs</i>	<i>Annual Electricity Demand (GWh/ yr)</i>
Gauteng	14,968	49
Kwa-zulu Natal	4,922	16
Western Cape	6,231	20
Eastern Cape	2,251	7
Mpumalanga	2,093	7
Free State	1,569	5
North West	1,573	5
Northern Cape	637	2
Limpopo Province	1,619	5
Total	35,862	116

Source: Bischof-Niemz, et al. (2017)

**Table 2.17: BEV numbers and Electrical Energy Demand per Province by 2030 (Medium Adoption Scenario)**

<i>Province</i>	<i>Number of EVs</i>	<i>Annual Electricity Demand (GWh/ yr)</i>
Gauteng	87,049	286
Kwa-zulu Natal	28,623	94
Western Cape	36,239	119
Eastern Cape	13,091	43
Mpumalanga	12,171	40
Free State	35,095	115
North West	9,147	30
Northern Cape	3,704	12
Limpopo Province	9,416	31
Total	208,562	770

Source: Bischof-Niemz, et al. (2017)

**Table 2.18: BEV numbers and Electrical Energy Demand per Province by 2030 (High Adoption Scenario)**

<i>Province</i>	<i>Number of EVs</i>	<i>Annual Electricity Demand (TWh/ yr)</i>
Gauteng	334,907	1,100
Kwa-zulu Natal	110,120	110,120
Western Cape	139,424	458
Eastern Cape	50,364	50,364
Mpumalanga	46,826	154
Free State	35,095	115
North West	35,192	116
Northern Cape	14,251	47
Limpopo Province	36,227	119
Total	802,405	2,860

Source: Bischof-Niemz, et al. (2017)

In this study, it was necessary to establish the number of vehicles per decile per province over the modelling period, so that estimations of BEV substitution could then be made based on targets established for the scenarios.

## 2.6 Modelling Methods for Electric Vehicle Studies

### 2.6.1 Requirements of the Method

In understanding the penetration rates of EVs, modelling tools and methods capable of incorporating the various driving factors impacting BEV penetration was required. The method to be chosen should allow for the understanding of the driving forces which impact the market penetration rates of electric vehicles in a non-linear fashion since they may expectedly be variables which may have to be modelled using feedback loops. The computer-based model should be structured in a way that allows for descriptive analysis and understanding of patterns of behaviour over time as opposed to deriving a least cost optimization solution. The system boundary may have qualitative and quantitative dependencies (based on the literature review) and thus a methodology capable of handling a wide spectrum of variables is required, while allowing for the identification of levers to effect change. The model should also have the ability to run scenarios against various policies related to electric vehicle adoption, to assist in effective strategic decision making within the context of energy planning. A survey of the possible modelling methods was conducted so that the most appropriate could be chosen.

### 2.6.2 Modelling Methods

Mathematical energy modelling tools, focussed on the energy-economy-environment nexus, have been critical in support of strategic business model development (Yan, Wang, Balezentis, & Streimikiene, 2018). Models developed specifically looking at EV dynamics were reviewed and are briefly summarised.

**Agent based models:** This is a computer simulation technique that describes the interactions of each decision-maker (i.e. agent), and in the case of EVs would include consumers, government, fuel producers, and vehicle manufacturers. This method is used mainly to look at vehicle technology adoption. Sullivan et al. (2009) was identified as the most comprehensive agent-based modelling study. The advantage is that it uses detailed data regarding agent characteristics and preferences, but this can be very complex and difficult to validate (Al-Alawi & Bradley, 2013).

**Consumer choice:** These approaches estimate the probability of consumer behaviour and include a few categories. Logit models are used to estimate the probabilistic preferences of consumers, while discrete choice models look at the probability of a particular product being selected. These models are useful if they are calibrated from detailed historic data on consumer demographics and past vehicle sales (Al-Alawi & Bradley, 2013). However, with technologies such as EVs, historical data may be limited, which then requires detailed survey information as well as results from “action-attitude gap” studies (Lane & Potter, 2007). The “action-attitude gap” study refers to the difference in what consumers may say they are going to do in relation to their actual actions. This method relies much on hypothetical data, which is the major disadvantage.

**Diffusion rate/time series models.** These models capture internal and external factors. Theories of diffusion include the concepts of early adopters, and the role of social influence, and uses S-shaped curves trending the rate of an innovation’s adoption, which is often modelled as a normal distribution over time. The most widely used diffusion models are the Bass, Gompertz and Logistics models, and they have been applied widely to the field of automobile markets (Al-Alawi & Bradley, 2013). The major advantages of diffusion models are that they can be fitted to the historical trend of the technology, but the disadvantage is that the time of peak sales, as well as the market potential, is exogenous to the model. Hence, many diffusion models include elements of both consumer choice and agent-based models.

The literature also indicates that **stochastic models** can be used to determine the future behaviour of EV users, and thus the impact on electricity demand (Grahn, 2014), if it is assumed that the movements of EVs are seen as independent and discrete states, namely: either parked or driving. When modelling variables within a system where uncertainty exists, stochastic models have been used where the estimated value is the mean value for an infinite number of observations of the stochastic variable. In the case of deterministic models, a specific input will result in a particular output. However, for stochastic models, the input could provide several outcomes based on a particular probability distribution (Cinlar, 1975).

With **Monte Carlo** methods, expected values can be determined by simulating a number of random observations of any stochastic variable, and then those observations are used to estimate the output value. Markov modelling and Monte Carlo simulations were used in the postgraduate doctorate study of Grahn (2014) where he investigated the impact of various EV charging patterns on the electricity grid.

**Markov modelling** is based on the theory that the next state of the process depends on the present state and not the previous states and can be applied for random car travelling, in terms of EV movements and EV charging demand (Grahn, 2014).

**Multinomial logit models** could also provide information (if combined with charging data) on individual EV charging preferences and decisions in order to evaluate the outcome of individual decision strategies in a population.

In another study, an **EU-TIMES-based model** was used to assess the future market penetration of EVs and to evaluate the factors which determine electro-mobility, such as battery costs and performance, and access to the grid for charging (Nemry & Brons, 2010). In this study the effects of policies, such as infrastructure and incentives to EV users, was included.

The impact of EVs on escalating energy costs and CO<sub>2</sub> emissions in 2020 was modelled using a **mixed-integer linear program**, known as the Distributed Energy Resources Customer Adoption Model (DER-CAM), using a General Algebraic Modelling System (Stadler, Marnay, Sharma, Mendes, & Kloess, 2011).

The Ministry of Business, Innovation & Employment (MBIE) in New Zealand published a document, which included results from modelling the future projections of electric vehicle fleet size and what the equivalent electricity demand for these vehicles would



be (Whakatutuki, 2015). The **Vehicle Fleet Model** was used by the Ministry of Transport with input information such as: National GDP, total household numbers, total population, retail diesel price, retail petrol price, and the uptake of electric vehicles. The results indicate a medium uptake scenario with an EV target of 4.9% from 2015 to 2040 resulting in 108,000 EVs by 2040 of which 34% would be BEVs. The high uptake scenario drives for a target of 43.8% EVs from 2015 to 2040. The electricity demand was linked to the fuel use by using a constant fuel efficiency of 0.17 kWh per kilometre travelled.

Many of these models included quantitative dependencies, which appear to be able to handle deterministic equations, integrating multiple variables in a complex system environment. However, these models lack the ability to represent the context of the problem by incorporating feedbacks, delays and nonlinearity into a transparent structure (Sterman, 2000) with an ability to highlight unintended consequences. Simulation computer modelling using system dynamics was identified as suitable in capturing the dynamic context of this study. A review of system dynamics models looking at the dynamics of EV market penetration was then conducted.

#### *2.6.2.1 System Dynamics Modelling*

Literature searches show a few system dynamics models linked to various aspects of EV dynamics. A system dynamics model was constructed and documented in a paper by Zhang & Qin (2014) to *explore private vehicle use in Beijing and its contribution to traffic congestion and air pollution*. The study also included reviewing policies that could support the adoption of EVs, but also control the number of private vehicles. The results of this study show that the government should build more charging stations and subsidize EV purchases to promote the uptake of EVs. The study also proposed that EVs be encouraged for the first 10 years after which the number of all private vehicles should be restricted, either by not issuing licence plates, and/or by prescribing the percent of vehicles that would be allowed on certain days.

Another study looked at the *factors that influenced the market share of EVs*, and combined system dynamics with agent based modelling (Yang, Zhou, & Liu, 2015). The factors included: demonstration promotion, rapid growth, and steady development. The conclusions are that the first 10 years will include rapid EV market growth, which will initially be a function of government policies, and then the development of technology and infrastructure construction.

System dynamics simulations were also used to *predict the market share penetration of hybrid (HEV) and battery electric vehicles (BEV)* over time in a study by Gorbea et al. (2011). The model links key influencing factors, such as: fuel price fluctuations, government incentives, customer network effects, vehicle cost of ownership/operation, and initial retail price differences between EVs and the internal combustion engine vehicle (ICEV); in a mathematical formulation. The simulation model uses the 2009 base specifications of the light duty vehicle market in the United States, and runs from 2009 to 2020. The results predict that by 2020, hybrid cars will increase from 4.5% to approximately 14%, and EVs from 0% to approximately 5% market share of new vehicles sold.

A federal grant was requested to support a collaborative study between the MPRC and the Social Science and Policy studies team at Worcester Polytech Institute. The study used system dynamics to develop a *regional energy model*, which included factors such as: land use, population growth, and energy use to be able to forecast energy demands (Vaudreuil, Guerin, Arnold, & Timms, 2011). Various types of vehicle data was obtained from the MPRC database which was included in the regional model such as demographics, social factors (school attendance, educational attainment, marital status), economics (occupation, income, job statistics), housing characteristics (house numbers, heating types etc.) and land use to profile the regional energy use. The model timeframe was 1970 until 2070, and indicated that at the end of the period, hybrid vehicle market penetration would result in a 9.3% drop in regional gasoline and diesel demand, while the electric vehicles would result in a 2.7% increase in electricity demand for the same period.

A study by Turan & Yucel (2014) on diffusion patterns for electric vehicles in Istanbul showed that the *diffusion of battery electric vehicle (BEV) and hybrid electric vehicle (HEV)* would likely reach around 19.76% and 20.77% respectively by 2042, with a CO<sub>2</sub> reduction in the transportation sector of around 17.32%. It was also noted that BEVs with or without technological improvements would penetrate 10% of the market within 30 years, while word of mouth and marketing activities had a greater impact to support the diffusion.

A system dynamics approach was also used in a study to determine the EV (passenger light-duty vehicles) *market penetration in key OECD countries* including China and India (Vilchez, Jochem, & Fichtner, 2013). The results of the study indicate that EVs can possibly reduce energy dependency on non-renewable resources and mitigate road CO<sub>2</sub> emissions. The importance of policy instruments was emphasized to support

the demand for EVs in OECD countries through introducing fiscal incentives and emphasis on cleaner technologies.

Testa (2017) completed a study using system dynamics to analyse the *relationship between policy, consumer behaviour, social dynamics, competition forces and the cost and performance developments*. This study built in time delays due to vehicle lifetime, development time for infrastructure, and the time needed for increasing consumer confidence in BEVs, which affect the expected exponential growth of BEVs. The challenges for increasing BEV sales were identified as not only being BEV competitiveness in price, cost and performance attributes, but also consumer confidence. The government targets for BEVs were not met both in Norway (where purchase tax is critical) and Sweden (where infrastructure subsidies are important). Other findings indicate that steady market penetration is expected in both countries although not exponential as expected, and the BEV is not expected to push the ICE vehicles out of the market by 2050 irrespective of any policies, since the key drivers such as cost and performance need to improve.

In conclusion, there have been various statistical and mathematical modelling approaches that have looked at different aspects of electric vehicle dynamics. System dynamics does not offer the exhaustive solution; however, it allows what the other methods have not considered, namely an integrated approach with feedback loops and time delays incorporating multiple drivers, allowing for non-linear dependencies within complex modelling environments, against which policy decisions can be examined through scenario analyses.

#### *2.6.2.2 Modelling Software for the System Dynamics Modelling Process*

There are various software options available and currently being used for system dynamics modelling, as shown in Table 2.19. Of this list, the most commonly used is iThink/ Stella, PowerSim Studio, and Vensim (SD Society, 2016).

For this study, iSee Stella was used, since it has been approved as the official software for the system dynamics modelling process by Eskom's Architecture Committee, and has been used to develop models since 2010 in Eskom SOC. Experience shows that the interfaces, which can be developed using this software, is very effective in allowing engagement of the dynamics which was covered in the model structure.

**Table 2.19: Summary of System Dynamics Modelling Software**

Software	Details	Licensing
Vensim	SD modelling, Monte Carlo simulation, model analysis, optimization, stocks and flows (Ventana Systems, 2015).	Free personal learning edition, proprietary, commercial
Powersim Studio	SD and discrete event modelling, includes sensitivity analysis, optimization, GUI builder (Powersim Software, 2016).	Proprietary, commercial, free 30 day trial
Stella/ iThink	SD modelling, mapping, CLDs, stock and flows, arrays, GUI, allows discrete and continuous processes, import/ export to CSV or MS Excel files (iSee Systems, 2016).	Proprietary, commercial
Anylogic	SD, agent based and discrete event modelling, allows development of hybrid models (System Dynamic Simulation, 2016).	Free personal learning edition, proprietary, commercial
Sysdea	Browser based modelling, stocks and flows (Sysdea, 2016).	Proprietary, commercial
Simulink	Integration with MATLAB (Klee & Allen, 2011).	Proprietary, commercial
Simantics	Free and open source, SD modelling, stock & flows, hierarchical models, arrays (Simantics, 2014).	Free, Public licence
Insight Maker	Web-based, multi-user, supports CLDs, pictures, mind mapping, stock & flow simulations, tables export to CSV, built-in functions and user created macros (Fortmann-Roe, 2016).	Free, Public License
Analytica	SD, Monte Carlo simulations, arrays, linear and non-linear optimization, influence diagrams (Lumina Decision Systems, 2016).	Proprietary, commercial, free limited edition
TRUE (Temporal Reasoning Universal Elaboration)	SD, 3D modelling, procedural animation, discrete and continuous, optimization (True World, 2015).	Proprietary, freeware

## 2.7 Summary

With commitments such as the Paris Agreement (European Commission, 2017), South Africa is required to reduce carbon emissions in the transport sector, through green initiatives, one of which is the introduction of electric vehicle technologies, guided by the country's Green Transport Strategy (DOT, 2016); but unless low carbon technologies are used to supply electricity to these vehicles, the carbon reduction potential is questionable (Wilson, 2013). This study will allow for scenario analysis of the impact of BEV substitution of ICEVs, on the residential demand and carbon emissions for a coal heavy supply mix and a renewables heavy supply mix from 1993 until 2050 to align with South Africa's latest Integrated Resource Plan (DOE, 2016).

Literature indicates that the affordability of BEVs using real disposable income on a provincial level and decile level in South Africa has not been established through quantitative methods. Some of the drivers affecting BEV market penetration, such as the BEV purchase price, increased driving range and more charging stations, may introduce feedback loops which results in a secondary increase in BEVs, in addition to the original target number of BEVs. The development of a mathematically sound system structure representative of the complex causal linkages would have to be built with feedback loops.

S&P Global Ratings has indicated a GDP growth forecast for South Africa of 2% for 2018, from 1% previously, and expects the economy to expand by 2.1% in 2019 (Creamer, 2018), while at the same time a study led by World Bank program leaders Sebastien Dessus and senior economist Marek Hanusch, premise that the income distribution in South Africa could improve with the Gini coefficient reducing from 0.628 in 2017 to 0.595 by 2030 (World Bank, 2018). The sensitivity and comparative difference between the impact of changes of GDP on residential demand and the Gini coefficient on residential demand will also be considered in this study so that insight is gained on which driver is more influential over the long-term.

The results from the literature survey also indicate that the risks and drivers for EV adoption are prevalent at various intensities and rates in different countries (Bessenbach & Wallrapp, 2013). Hence the same business models applied to other countries to determine the rate of market penetration of BEVs would not be applicable to South Africa.

Various drivers determine the success of EV adoption, including, but not limited to, the vehicle retail price (linked to production costs, import taxes, VAT, insurance premiums, subsidies, and battery costs), range anxiety as a function of battery technology, fuel consumption and reputation as perceived by consumers. Although scenarios will be run with various BEV targets for South Africa, the effect of the drivers affecting the EV adoption adds a feedback loop, which increases this target, which this study will incorporate, and refer to as the secondary BEV penetration.

After reviewing various modelling methods that have been used to understand BEV dynamics, it was clear that the modelling process incorporating the requirements necessary for this study was a system dynamics modelling process. No publications were identified, which used this modelling process to causally link disposable income to the affordability and adoption of BEVs, and especially in the South African context.

# Chapter 3: Research Methodology

---

## 3.1 Overview

Chapter 2 supported contextualising the problem with a detailed literature review of the dynamics linked to the problem and its environment, including the most suitable modelling approach to be followed. This chapter details the research methodology and modelling process that was followed. It also explains the system dynamics modelling process used in Eskom SOC, which allows for the implementation and use of developed models.

## 3.2 Method Selection

### 3.2.1 Requirements of the Method

The nature of the power utility's operating environment in the context of socio-economic, political and environmental changes requires an evolving business model with a dynamic planning approach (Ervural, Evren, & Delen, 2018) capable of understanding feedback behaviour across the electricity value chain (Krishnan, et al., 2016). To develop strategically sound business models for economic and environmentally conscious competitive advantage, advanced modelling tools and processes are required (Dyner & Larsen, 2001; Foley, O Gallachoir, Hur, Baldick, & McKeogh, 2010). After reviewing various methods that have been used to model BEV dynamics, it was necessary to follow a modelling process incorporating the method but also supporting a group model building approach to contextualise and frame the research problem and allow for preliminary system analysis before modelling the structure of the system.

A system dynamics methodology was chosen to allow for the understanding of the driving forces which impact the market penetration rates of electric vehicles in a non-linear fashion since they may expectedly be variables which may have to be modelled using feedback loops. The computer-based modelling process allows for descriptive analysis and understanding of patterns of behaviour over time (Brown, 2016), as opposed to deriving a least cost optimization solution. The system boundary may have qualitative and quantitative dependencies (based on the literature review) and thus a methodology capable of handling a wide spectrum of variables is required, while allowing for the identification of levers to effect change. The model should also have

the ability to run scenarios against various policies related to electric vehicle adoption, to assist in effective strategic decision making within the context of energy planning. The system dynamics modelling process will be explained in detail following the historical context.

### **3.2.2 Background and history of method: System Dynamics**

Professor Jay Wright Forrester (ex-Chair at the MIT Sloan School of Management) became involved in a project whilst heading up the Sloan School of Management in the mid-1950s when the General Electric Corporation managers were confronted by oscillations with a three-year period in their component inventories and workforce numbers. The cause of the problem had initially been attributed to business cycles and despite various management interventions, the oscillations could not be resolved. Forrester's view of the situation was that the system had many feedback loops so through hand calculations and drawings, he confirmed that the effect of the internal policies being implemented were generating the opposite effect to the one intended and was in fact worsening the oscillations; this then was the beginning of system dynamics (Lane, 2007).

In Africa, system dynamics is still a growing science, but has nevertheless been successfully used by various institutes in disciplines such as: new technology impacts, sustainability (specifically climate change and biofuels), renewables, and medical practice (Brent, 2018; Brent, et al., 2016). In South Africa, Eskom SOC, has developed specialised system dynamics skills since the first system dynamics simulation was developed in 2010 and presented to the company's Executive Committee and Board of Directors, as part of a scenario-planning project. The simulation proved advantageous in describing the system structure and to allow for scenario analysis, to challenge and even change previous mental models, as identified by Schoemaker (1995).

It became apparent that the acceptance and successful implementation of system dynamics models relied on the modelling process used with stakeholders, the effectiveness of engagements, as well as the identification of non-intuitive leverage points, which all culminated in an adapted system dynamics modelling process. This amended modelling process has been successfully applied for scenario analysis for many system problems across the electricity value chain including determinants of the 21<sup>st</sup> century energy security using systems thinking principles (Nel & Pillay, 2013), income distribution dynamics (Pillay, Nel, & Cohen, 2014), simulation of the South African forestry and logging industry (Koegelenberg & Pillay, 2015), hydro pumped



storage dynamics (Ntsoane & Pillay, 2015), simulating key performance indices (Memela & Pillay, 2015), the long-term role of coal in the generation supply mix (Booyens & Pillay, 2016), demineralised water production planning (du Plooy, 2016), and factors impacting electric vehicle monthly repayments (Pillay, Brent, & Musango, 2018).

### 3.2.3 Overview of the System Dynamics Modelling Process

The system dynamics modelling process requires several steps, as shown in Figure 3.1 (Richardson & Pugh III, 1989).



**Figure 3.1: System Dynamics Modelling Process** (Richardson & Pugh III, 1989)

Following a detailed process prevents the modeller from conceptual problems, and provides necessary contextualisation of the system problem to be modelled.

**Step 1: Problem Identification and System Conceptualization:** This step includes defining the problem dynamically with or without the use of data, since the behaviour of a system variable over time follows a pattern that can be illustrated (Richardson & Pugh III, 1989). After identifying the problem, key variables and reference modes (historical data/pattern of behaviour of variables); feedback structures are identified. For this purpose, causal loop diagrams (Systems Thinker, 2011) illustrate the visual cause-effect and loops of role-playing variables related to the system problem (Randers, 1976).

Part of this step includes a clear model purpose. Sterman (2016) refers to this step as *Problem Articulation*, which also includes defining time horizons. Considerations include obtaining and studying historic data and trends, also referred to as historical reference modes (Sterman, 2000). These reference modes become important since they can provide clues as to what system behaviours could potentially arise, and model runs can be compared against the trends obtained from the historical data as an indication of how accurate the model is or whether rework is required (Albin, 1997). Behaviour modes and defining boundaries are also critical and include variables that



may be endogenous (determined within the system of equations representing the real world) or exogenous (whose value is determined by variables outside the causal system under study) (Nagler, 1999).

**Step 2: Model Formulation:** This includes formulating rate equations and defining the variable parameters and initial values, when stock flow structures (as illustrated in Figure 3.2), which model the dynamic system behaviour based on the “*Principle of Accumulation*”<sup>6</sup>.

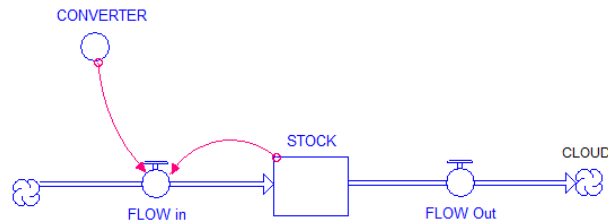

**Figure 3.2: Illustrative Stock Flow Diagram**

Source: Sterman (2000)

These stock flow structures illustrate that the dynamics behaviour in a system arises when flows accumulate in stocks. The elements or primary components that make up a stock flow diagram are explained in Table 3.1 (Sterman, 2000). Equation 3.1 forms the basis of the calculations represented illustratively in Figure 3.2:

$$Stock(t) = Stock(t-dt) + (Inflow\ Rate - Outflow\ rate) \times dt \quad \text{Equation 3.1}$$

The differential equation tells us that the Stock at time  $t$  is found from the Stock at a previous point in time,  $(t-dt)$ , by adding the net quantity accumulated as the result of the inflow and outflow during the period  $dt$ , basically a first order differential equation (Fuchs, 2006).

System dynamics modelling incorporates feedback, which is when the effects in one variable cause a change in another variable and the effects then trail back to the first variable (Monga, 2001).

---

<sup>6</sup> Principle of Accumulation states that “all dynamic behaviour in the world occurs when flows accumulate in stocks”

**Table 3.1: Components of System Dynamics Modelling**

COMPONENT	DEFINITION
<b>Stock</b>	Can accumulate or deplete and can only change through flows.
<b>Flow</b>	Determines rate of change.
<b>Converter</b>	Could be constants or time series data inputs or equations and could be connected to other equations that can be constructed to define relationships between variables.
<b>Connector</b>	Is a link that carries information about the current state of the system (the stock value)
<b>Cloud</b>	If attached to the inflow is known as a source and if attached to the outflow is known as a sink and can be infinite when undefined by variable relationships or mathematical boundaries.

Source: iSee Systems (2016); Sterman (2000)

Coyle (1996) included influence diagrams in the second step, and Sterman (2016) included various other tools, such as a model boundary chart (which indicates which variables are endogenous (outputs), exogenous (inputs) or excluded in the model structure), subsystem diagram, causal loop diagram, stock and flow maps and policy structure diagrams. The causal loop diagrams or system diagrams may be constructed by group model building, a facilitated participatory modelling method whereby stakeholders are guided through a brainstorming session to determine as many variables and relationships of these variables linked to the system problem (Vennix, 2000). The causal loop diagram (CLD) supports systems thinking by showing that reality is composed of circular influence instead of linear influence structures (Haraldsson, 2000).

**Step 3: Model Testing and Further Development:** Understanding model behaviour and sensitivity runs, refinement and reformulation, as well as validation, characterise this step. The iterative nature of the modelling process is emphasised where the iterations depend on the complexity of the system problem being modelled. Sensitivity analysis is based on 3 main categories: numerical (if parameters change with numerical values) (Maly & Petzold, 1996), behavioural (model behaviour and pattern over time changes when parameters change) (Hekimoğlu & Barlas, 2010), and policy sensitivity (checking model runs against policy based conclusions) (Forrester & Senge, 1979).

**Step 4: Policy Analysis:** At this stage, sensitive policy parameters are identified, the ones which result in the most change in influencing the system and would tend to be

the areas to be leveraged, besides the feedback loops which dominate behaviour (Richardson, 1991).

### 3.3 Adapted System Dynamics Modelling Process

Eskom SOC developed an Integrated Strategic Electricity Plan (ISEP), which includes complex dynamics that require extensive time to read through and filter out salient points so that decision makers can establish mental models based on perceived contextualisation (Pillay, Brent, & Musango, 2018). The process to support the development of the organizational strategies (Snabe & Grobler, 2006; Rouwette & Vennix, 2006) requires advanced modelling and includes system dynamics as an additional modelling process, incorporating group model building (Vennix, 2000), which could provide causal linkages and feedback loops for hundreds of variables and provide understanding of the system problem by allowing various sensitivity and scenario analysis (Forrester & Senge, 1979).

The adapted eight-step system dynamics modelling process includes some group model building elements (Andersen & Richardson, 1997), including system conceptualization, model formulation and decision making, with an emphasis on those practical aspects of project scoping, model communication and knowledge transfer necessary for implementation of models and modelling solutions (Figure 3.3) and was applied to this study.

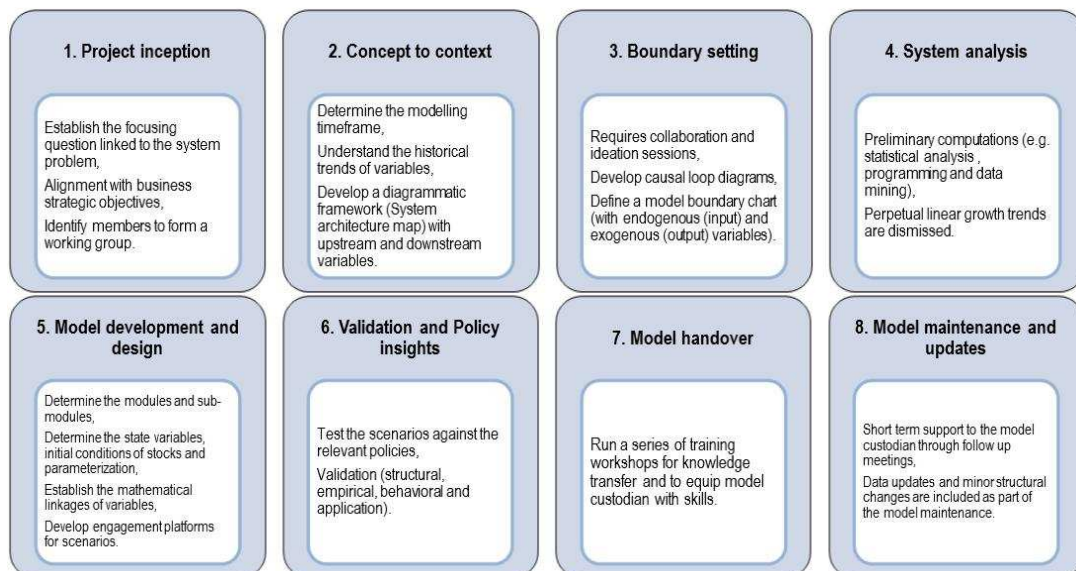

**Figure 3.3: Adapted System Dynamics Modelling Process**

### 3.3.1 Project Inception and the Identification of the Appropriate Customer/Custodian

A project may be initiated by a customer or be proposed by a system dynamicist (based on their experience, technical knowledge and understanding of the company's corporate objectives and business priorities). If the system dynamicist proposes a system dynamics model for development, they identify a potential custodian who is on an executive level with sufficient business influence. The custodian then nominates a technical owner who would be trained in using the completed tool, running the relevant scenarios, and reporting the results to the senior decision makers. Generally, the initial challenges for a system dynamicist is being presented with broad scopes to deliver on specific results using a system dynamics model. The system dynamicist has to engage with stakeholders (sometimes even on multiple occasions) until a focussed question is defined to address a particular business system problem. Generally, the customer has conceptualised what they think should be developed through their mental models, but experience difficulty in contextualising their ideas and formulating a focussing question. For customers/custodians with no prior system dynamics knowledge, successfully completed system dynamics tools are presented to the potential customer, relevant to their business interest with a discussion of how the results from the tools have been used for strategic cost benefit analysis or enhanced system understanding for improved decision making. Part of this step also involves identifying members to form a work group to engage with on a regular basis. The work group would consist of the system dynamicist, the custodian/customer, technical engineering members, environmentalists, financiers, subject matter experts etc.

The following points are emphasised as part of the first step:

1. The model results are not accurate to decimal places and should be used to understand changes in the pattern of behaviour as opposed to predicting behaviour, very much aligned to the concept of exploratory modelling<sup>7</sup> (Bankes, 1993). Linked to this point, the model is not predictive, but descriptive (Shmueli, 2010).
2. The structure is developed in a mathematically sound manner, but cannot be altered to provide bias for a predetermined result or output.
3. The model still requires engineering judgement and understanding of system behaviour through various scenario runs (used during strategic dialogues).

---

<sup>7</sup> Exploratory modelling is where a series of computational experiments are used to explore the implications of varying assumptions and hypothesis (Bankes, 1993)

4. Validated empirical data would be required for input into the model structure. However, calibration of the model can also take place through experience, in cases where data is lacking.
5. There is a need for a defined system boundary at the project inception stage to prevent project scope creep<sup>8</sup>, and also to balance model complexity with level of understanding i.e. the level of understanding of the model increases and reaches a maximum at a certain level of complexity after which understanding decreases with increasing complexity.

To further “empower” the customer, a condensed 2 day systems thinking and system dynamics internally facilitated course is offered to the stakeholders so that the system dynamics modelling structures, system dynamics method, and software tools are well understood. The additional knowledge also helps in initiating more system dynamics projects in a particular business area due to the understanding of the versatility and limitations of the system dynamics modelling process by the stakeholder. If a customer approaches the system dynamicist with a proposal for an system dynamics project, it does not preclude other potential clients who may also find value in the tool, from using it, unless the customer specifically requests sole proprietorship.

This study was proposed by the author to align with the priorities in the business corporate plan. Stakeholders consisted of the university supervisors as well as the eMobility project team at Eskom SOC (2018).

### **3.3.2 Conceptualisation to Contextualisation with a Theoretical Framework**

In supporting the customer to contextualise the project requirements, they are advised to suggest what graphical outputs or variables they would like to understand by running the model. This does not prescribe a preconceived result in terms of the emergent model solution, since the trend or graphical result may be non-intuitive and unexpected but it allows reflection on the system variables which may have to be reported on, and establishing a focussing question. Part of contextualising includes establishing a suitable modelling timeframe. The timeframe provides insight in determining the resolution of data which would be required. Depending on the resolution of data, different data owners are identified for further liaising or workgroup members.

---

<sup>8</sup> Uncontrolled changes are often referred to as project scope creep

For this study, the simulator started in 1993 to be able to understand the historical trends of variables and to establish mathematical equations, which could then be used to simulate future behaviour over time. The end of the simulation timeframe was to coincide with the timelines for the Green Transport Strategy (DOT, 2016), and the Integrated Energy Plan (DOE, 2016).

The system dynamicist then constructs a diagrammatic framework based on the operational and theoretical information linked to the system problem being modelled. This framework illustrates the high level system architecture map of the system problem and the related environment, in support of problem contextualisation (Figure 3.4). It does not display cause and effect relationships or directional quantities linked to the variables, but includes important upstream and downstream variables, driving forces and externalities specific to that environment. The value of such a map helps with engaging with the stakeholders on a first pass and has proven to be very effective. It assists in the system dynamicist acquiring the necessary basic system problem understanding on a more technical level since it requires extensive literature reviews before it can be drafted. It can, thereafter, through engagements, be verified by the customer as being the correct framework meeting the project specification. This step also requires high level assumptions (e.g. exclusion of the discrete raw material cost elements in the production cost module) to be agreed upon and possible proxies where no data may be available for quantitative mathematical equations.

In Figure 3.4, the electricity supply and demand modules were developed and then used to determine the reserve margin. The supply module was comprised of various generation options (fossil fuel, nuclear, gas, hydro, renewables) and was used to calculate the carbon emissions with coal making up base load. The vehicle module was made up of BEVs (requiring electricity for charging) and ICEVs (which also contributed to carbon emissions). The disposable income in the residential sector was used to calculate vehicle affordability, whilst various drivers are linked to the BEV module to further assess influences on BEV market penetration.

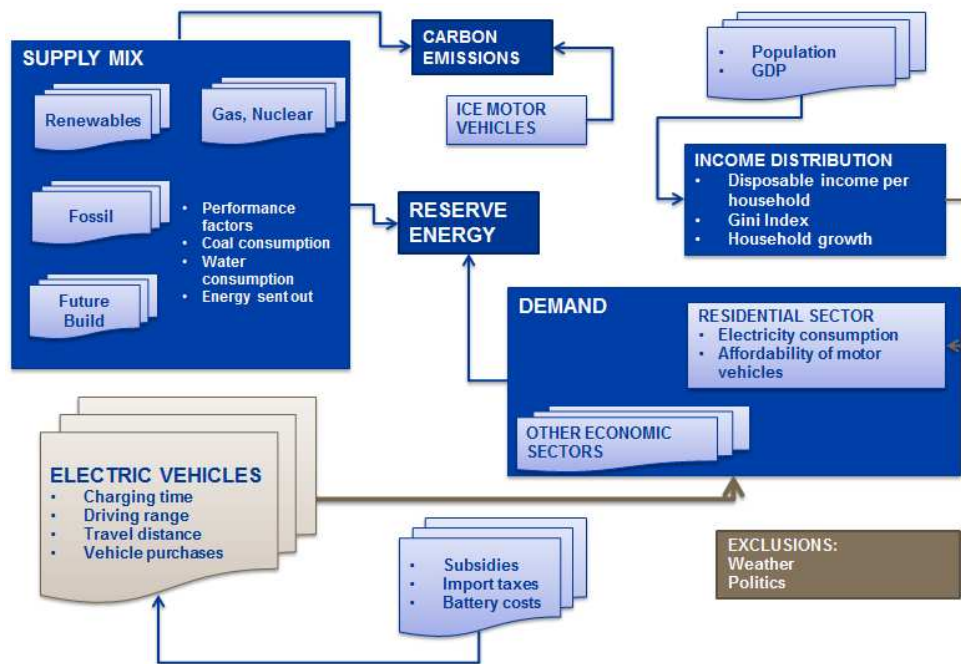

Figure 3.4: System Architecture Map

### 3.3.3 Collaborative Brainstorming and Boundary Setting

The constitution of a collaboration and ideation team is critical and relates back to group model building exercises (Vennix, 2000), since the output – developing a causal loop diagram (CLD) - can be subjective. The quality of subjective outputs, such as the CLDs, depend largely on the collective knowledge and experience of the participants, hence the emphasis on carefully selected participants. The system dynamicist facilitates the interactive and carefully managed session and directs the discussion around those aspects related to the system problem, by steering the group clear of emotionally charged arguments. This process is usually started by using sticky notes, one per variable. The CLD is usually finalised in a follow up session with the group after the system dynamicist completes the first draft. CLDs may be revised and be part of an iterative dynamic process over the life of the project. At this stage, the system dynamicist is equipped with a very clear idea of the variables that would be included in the model boundary chart. The stakeholder discussions would also help finalise the assumptions necessary for further work and those variables which may be excluded due to the required customer-defined project scope.

The model boundary chart for this study is shown in Table 3.2, and lists exogenous variables (not affected by the state/ feedback loops of the model), endogenous



variables (dependent on the system state), and excluded variables (not taken into account in the model) for the project.

**Table 3.2: Model Boundary Chart**

Exogenous Variables	Endogenous Variables	Excluded Variables
<ul style="list-style-type: none"> <li>• Electricity supply options (MW)</li> <li>• Population</li> <li>• GDP (R)</li> <li>• Travelling distance (km)</li> <li>• Disposable income (R)</li> <li>• BEV import taxes (R)</li> <li>• Vehicle Insurance (R)</li> <li>• Registered ICEVs</li> <li>• Battery life</li> <li>• Gini coefficient</li> <li>• Range anxiety</li> </ul>	<ul style="list-style-type: none"> <li>• CO<sub>2</sub> emissions (Mtons)</li> <li>• BEV charge demand (kWh)</li> <li>• Energy and capacity reserve margin (%)</li> <li>• Residential electricity consumption (GWh)</li> <li>• Economic sector electricity demand (GWh)</li> </ul>	<ul style="list-style-type: none"> <li>• Infrastructure</li> <li>• Weather</li> <li>• Politics</li> <li>• Well-to-wheel vehicle efficiencies and production costs</li> <li>• Time of use charging</li> </ul>

Figure 3.5 provides a visual representation of the high level dynamics and the drivers impacting the market penetration rate of BEVs and the impact on electricity demand

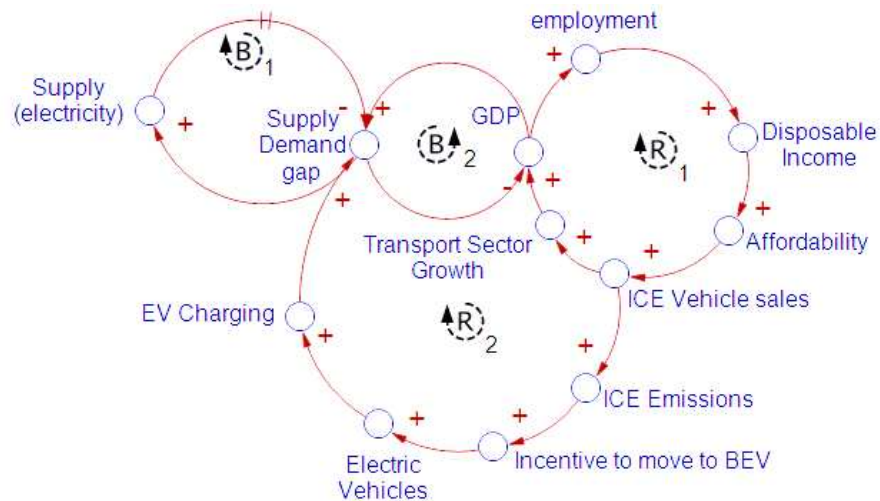

**Figure 3.5: Causal Loop Diagram of Factors Affecting BEVs**

If the electricity supply-demand gap is big, then the supply needs to increase to close the gap, which then also results in less supply required (**Electricity Supply-Demand: Balancing Loop 1**). The Gross Domestic Product (GDP) serves as a proxy for the economic health of the country. When the economy experiences growth (in the



services, transport, agriculture, forestry and fishing, industrial sectors), the gap between supply and demand of energy becomes smaller. When the gap gets smaller, the GDP may be influenced by balancing factors, which slow down economic growth (**Economic Growth: Balancing Loop B2**).

In South Africa the predominantly coal-based base load meets this supply. An increase in GDP usually results in employment, which supports the drive to a more equal income distribution. In the residential sector, this means more average real disposable income per household. An increase in real disposable income means consumers can afford purchasing motor vehicles, which supports transport sector growth and the overall economy (**Income Distribution: Reinforcing Loop R1**).

An increase in ICEV sales results in more carbon dioxide emissions. In the national drive to decarbonize our environment, an increase in carbon emissions in the transport sector incentivizes consumers to purchase more electric vehicles. The introduction of BEVs increases the demand for electricity required for charging and increases the supply-demand gap (**Transport Sector: Reinforcing Loop R2**).

Figure 3.6 shows the causal loop diagram (CLD) of the factors affecting BEV market penetration and monthly repayments that were considered in this study.

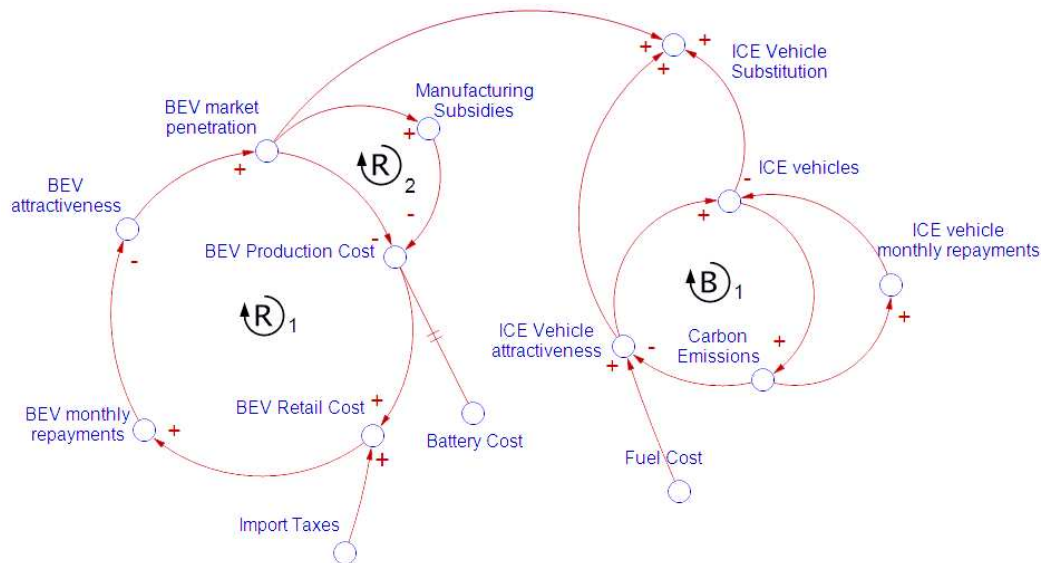

**Figure 3.6: Causal Loop Diagram of BEV Drivers**

**BEV Attractiveness Loop (R1):** BEV production costs are significantly influenced by the cost of the lithium-ion batteries (limit control). If the battery costs decrease, then the

overall BEV production cost will drop, thus resulting in a lower retail vehicle value. The retail cost is also impacted by import taxes (currently at 41%) and if import taxes decrease, the overall BEV retail cost similarly decreases. Lower retail costs allow for lower BEV monthly repayments. With lower BEV monthly repayments, BEVs become more attractive and affordable to the average consumer who then proceeds to purchase BEVs, thus increasing the market penetration for BEVs. This ultimately increases the substitution of ICEVs with BEVs.

**Manufacturing Incentive Loop (R2):** The need for more BEV market penetration results in manufacturing subsidies being used to incentive producers of electric vehicles for large volumes of BEVs. The introduction of manufacturing subsidies reduces the production cost and leads back into reinforcing loop R2.

**Internal Combustion Engine Vehicle Attractiveness Loop (B1):** ICEVs result in high carbon emissions which reduce the attractiveness of ICEVs which then decreases the overall number of ICEVs in the passenger car market. Fuel cost is also a deterrent and limit control on ICEV attractiveness for the lower and middle income groups. Factors such as the exchange rate and the oil price impact the cost of fuel required for ICEVs. If the fuel cost decreases then the number of ICEVs increases, but this results in increased carbon emissions in the transport sector. The carbon emissions then results in a penalty for commuters, which further reduces the attractiveness of ICEVs, again increasing ICEV substitution with BEVs.

### 3.3.4 System Analysis

Experience has shown that there are many organizational misconceptions that the system dynamics modelling software constitutes to the system dynamics modelling process. The reality is that significant time should be spent on problem identification and contextualisation, as well as data and system analysis, before commencing with the structural design of the system dynamics model. In a document on Supervisory Guidance on Model Risk Management, the Board of Governors of the Federal Reserve System summarises why one should not immediately commence with model development (2011):

*“The model may have fundamental errors and may produce inaccurate outputs when viewed against the design objective and intended business uses. The mathematical calculation and quantification exercise underlying any model generally involves application of theory, choice of sample design and numerical routines, selection of*

*inputs and estimation, and implementation in information systems. Errors can occur at any point from design through implementation. In addition, shortcuts, simplifications, or approximations used to manage complicated problems could compromise the integrity and reliability of outputs from those calculations.”*

The preliminary analysis could include statistical methods or programmable codes to determine patterns or relationships or simply involve a process of ordering and simplifying both qualitative and quantitative data into a time resolution suitable for importing into the system dynamics model. The empirical data may have gaps which may require classical regression, time series decomposition, least squares approximation, numerical interpolation or exponential smoothing or a combination of data analysis techniques.

Perpetual linear growth trends are dismissed on the premise that real systems elements have biophysical constraints and if the appropriate time period has been selected, these trends tend to plateau and reflect the carrying capacity of the system. This step is also critical since it can help the system dynamicist establish if any integration errors or incorrect structural linkages have been made, which may result in large variances in the results once the modelling software is used. Preliminary calculations have also assisted in the initiation and development of smaller system dynamics models, which have been used as stand-alone tools for some customers.

On conducting an analysis into the BEV data and the electricity load data, it was apparent that there was a need for a short-term system dynamics simulator to be developed before developing a long-term strategic simulator. The short-term simulator would be necessary because the different modelling time resolution would allow an understanding of the hourly trends for electricity demand and vehicle charging times, before using any statistical empirical data for the long-term simulator with its annual resolution from 1993 until 2050. The short-term simulator used hourly BEV data for year 2015 since there had been the extensive logging for this year of the Nissan-Eskom pilot study (Langley, 2015).

#### *3.3.4.1 Electricity Load*

Since charging and electrical energy consumption data was being used for 2025 for the BEVs, it was important to understand the typical electricity load trends, which were recorded per hourly per day per month for year 2015. The electricity load raw data was in the format shown in Table 3.3.

**Table 3.3: Electricity Load Hourly Data (MW)**

	Hr00	Hr01	Hr02	Hr03	...	Hr23
01/01/2015	23077	22783	22545	22606	...	
01/02/2015	23169	22811	22708	22700	...	

The coefficient of variation was calculated for the hourly data per month and all had a coefficient of variation of less than 1 which indicated that an average/ mean could be taken for that month (Figure 3.7). This part of the process allowed an understanding and analysis of the times at which the peak loads (MW) occurred, as well as the monthly and seasonal variations in peak load.

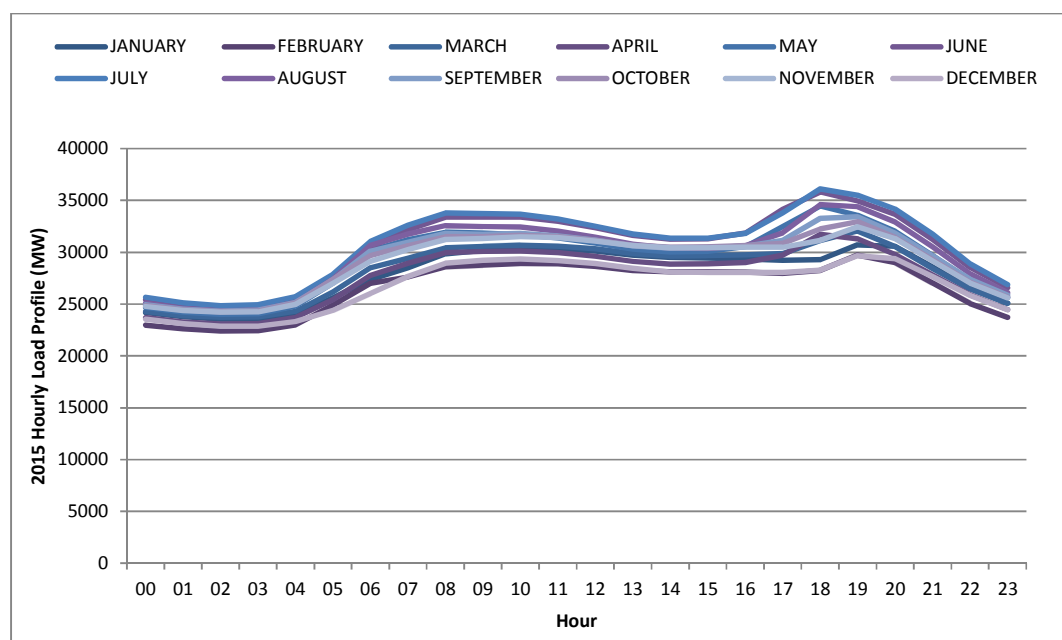

**Figure 3.7: Average Hourly Demand per Month in 2015**

Figure 3.8 shows the monthly load profiles for understanding overall seasonal trend analysis. This data was used as exogenous variables in the Short-Term Electric Vehicle Simulator (STEVsim). Refer to Appendix A for all the monthly electricity load profiles for 2015.

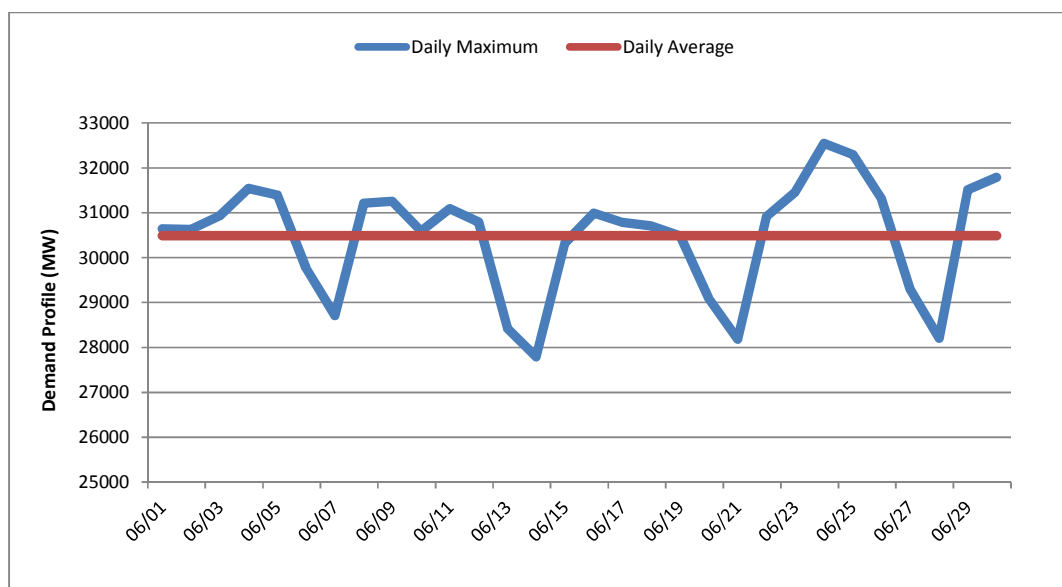

**Figure 3.8: Daily Electricity Load Profiles – June 2015**

#### 3.3.4.2 BEV Data Analysis

MS Excel was used to trend the hourly demand load profiles and the BEV charging and consumption profiles. Due to the huge volume of hourly BEV data, preliminary data mining was necessary. On average, each vehicle had over 3800 rows of data and the format of data shown in Table 3.4. It was important to note that although 10 BEVs had been test driven and piloted, the logger for the 10<sup>th</sup> BEV did not provide consistent data and was excluded from the analysis.

**Table 3.4: BEV Raw Data**

Device	Status	Duration (s)	Duration (hh:mm:ss)	Distance (km)	Start SOC	End SOC	kWh Used	kWh Charged	TripStartDT
Car 1	Standing	556	0:09:16	0.000	93.8%	87.2%	0.009	0.000	2014-01-28 13:51:12.000
Car 2	Driving	10	0:00:10	0.000	87.2%	87.2%	0.000	0.000	2014-01-28 14:00:28.000

Source: *TripStartDT* (Langley, 2016)

The first task was to filter out the 2015 data from the 2014 data to merge with the load profile information available for year 2015. It was immediately evident that the data was not consistently logged daily, and that the number of data records varied daily. This meant that the load forecast data per hour could not be exactly matched to similar hourly data from the BEV logging system.

Sub-routines (macros) using MS Excel Visual Basic were compiled to calculate the following per vehicle (refer to Appendix B for the Macro code):

- Sum of the electrical energy used (kWh) daily per month,
- Sum of the charging energy requirements (kWh) daily per month,
- Total distance travelled (km) per day,
- Sum of the Start State of Charge (SOC - %) daily per month,
- Sum of the End State of Charge (SOC - %) daily per month,
- Average daily Start State of Charge (SOC - %), and the
- Average daily End State of Charge (SOC - %).

All of the above were then programmed to be listed sequentially as rows of days per month with the relevant value. Thereafter, a master spreadsheet had to be compiled to consolidate all the different daily values for all the cars. This was a time-consuming process since each of the cars had missing or no values for some days and rows of missing data days had to be identified. At the end of this exercise, the following information was obtained:

- Fast charging as a fraction of overall charging,
- Vehicle usage profiles,
- Average daily charging and consumption profiles,
- Daily average distances travelled during weekdays and weekends, and the
- Relationship between charging and the distance travelled.

Assumptions on the most plausible reason for the following trends were made since the pilot study did not have the necessary detail on the driver feedback to explain the reason for some of the behaviours associated with the trends.

#### *3.3.4.2.1 Fast Charging*

The data reflects a general decrease in the rate of fast charging compared to Level 2 charging. It is also noted that one of the BEVs had an extremely high percentage (33%) relative to the average 8% (disregarding null values) for the fleet over the entire pilot period. Overall, for the majority of drivers, Level 2 charging increased in the second year for the BEVs.

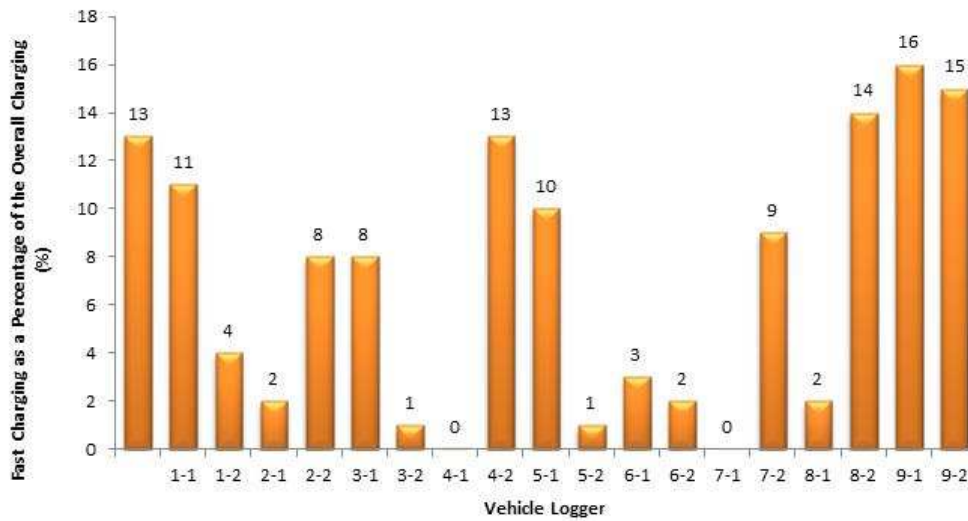

**Figure 3.9: Fast Charging as a Percent of Overall Charging**

### 3.3.4.2.2 Mobility Profile

Figure 3.10 shows the mobility profile of the BEVs. The trends indicate that if the BEVs were not being used, they were mostly being charged.

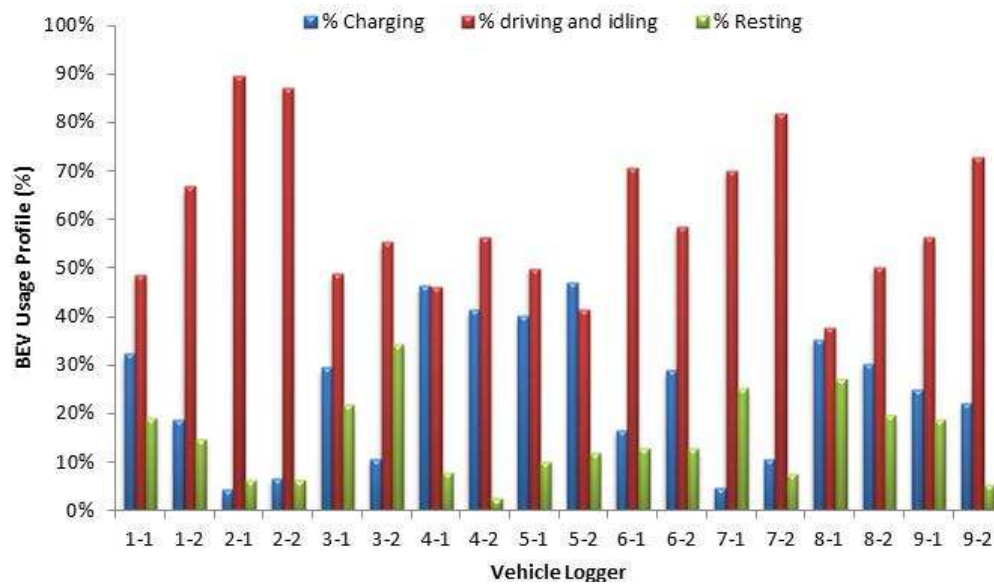

**Figure 3.10: Vehicle Usage Profiles**

### 3.3.4.2.3 BEV Charging and Consumption Profiles

From the empirical data, July 2015 profile had the highest BEV charging requirement compared to any other month of the year, so data for this profile was chosen to be input into STEVsim, to plan for the “worst case” in terms of the highest electrical charging requirements and consumption by BEVs (Figure 3.11). The monthly BEV charging and consumption profiles in 2015 are included in Appendix C.

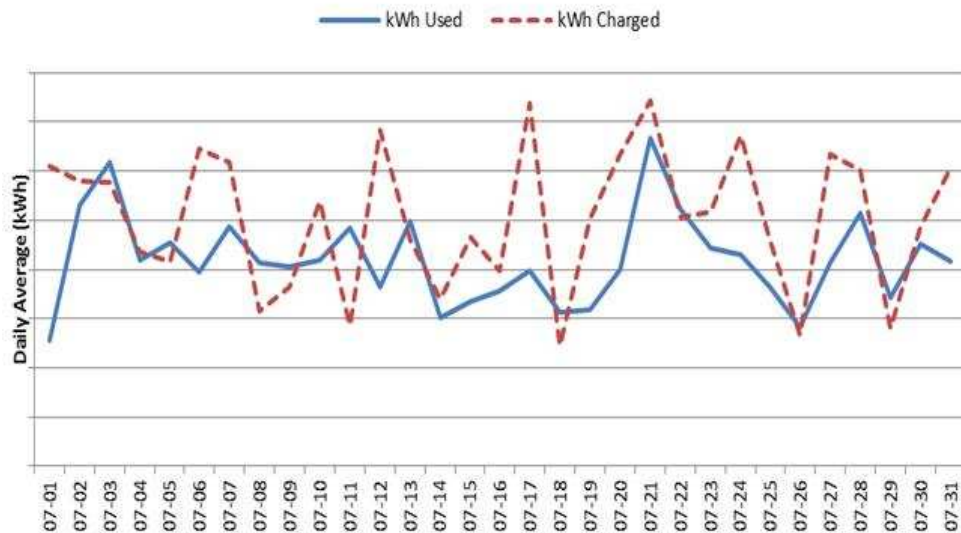

**Figure 3.11: Daily Average Consumption and Charging profiles – July 2015**

### 3.3.4.2.4 BEV Distance

Figure 3.12 indicated a significantly higher fraction use of the vehicles on weekdays for work commuting as a percent of the total commuting. The weekend minimum was 75% and the weekend maximum was 99%; while the weekday minimum was 1% and the weekday maximum was 25%.

Data indicated a significantly higher total mileage of the vehicles on weekdays for work commuting. Using the data logged over 2 years of the pilot BEV study, the coefficient of determination ( $R^2$ ) was calculated for the electrical charging energy consumed (kWh) and the distance travelled (km). A regression equation was then obtained from the linear fit ( $R^2=98\%$ ), as per the following equation.

$$\text{Charge}=(0.1671 \times \text{distance})-118.11$$

Equation 3.2



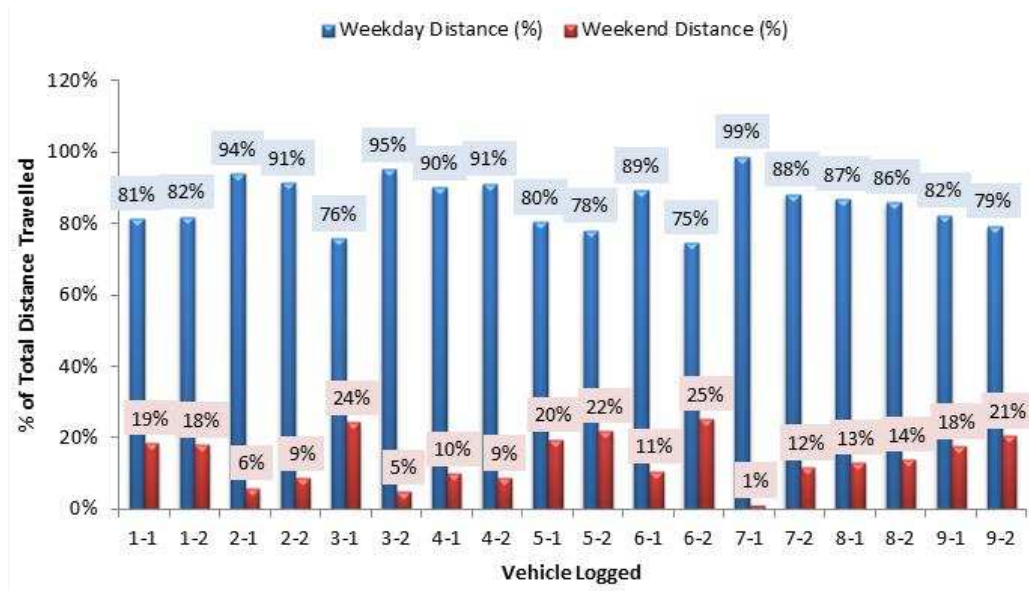

**Figure 3.12: Vehicle Distance Travelled (Weekday Vs Weekend)**

The average daily distance for July (month with the most BEV charging), is shown in Table 3.5. This average daily fuel consumption was 14.1 – 21 kWh per 100 km with an average daily distance of 71 km based on empirical data.

**Table 3.5: Daily Average BEV Distances (July 2015)**





Day	Distance (km)	Day	Distance (km)
1	83.54	16	60.82
2	91.75	17	68.67
3	82.76	18	53.61
4	75.75	19	43.94
5	58.5	20	55.94
6	92.98	21	78.82
7	85.51	22	102.57
8	60.48	23	83.88
9	52.47	24	80.6
10	69.46	25	69.13
11	59.45	26	65.33
12	75.17	27	52.4
13	81.95	28	86.35
14	69.55	29	74.86
15	56.47	30	57.01

### 3.3.5 Model Development and Design

The model structure may be designed to represent component configurations on the power plant, causally and mathematically linking the variables identified in the CLD, the MBC and the system architecture map. The iSee Stella software used in developing the system dynamics model also allowed for an engagement platform to be built which the customer could use to interact with the model and run scenarios. Some of the engagement elements in the iSee STELLA system dynamics modelling software to support the design and development of the interfaces for running scenarios is summarised in Table 3.6 (iSee Systems, n.d.).

Once the model has been developed, the first “Beta” version is usually handed over to the model owner and customer. They engage with the interface and run various scenarios, a process which does not require in-depth knowledge of the model structure. It has been found that only when the model is run by the model owner do they pick up elements, which they would like to have changed, despite having various demonstrations by the system dynamicist during previous meetings. The additional “tweaking” and fine tuning of the simulation is then concluded.

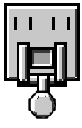
**Table 3.6: Interface Tools to Engage with the iSee STELLA Model**

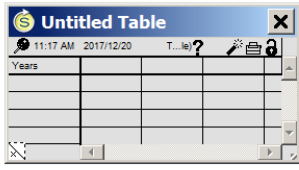
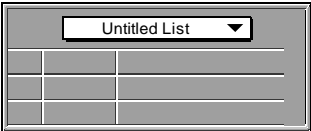
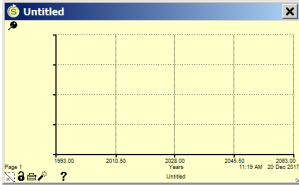
	<p>A <i>knob</i> allows the user the ability to select various values between a minimum and maximum assigned to that variable (on the converter which has the knob).</p>
	<p>A <i>slider</i> is also assigned to a converter containing data linked to a particular variable and can be adjusted from left to right or vice versa, also restricted by a minimum and maximum value.</p>
	<p>The <i>numeric display</i> displays the current or last value for the simulation calculation period.</p>
<div style="display: flex; justify-content: space-around;"> <div style="text-align: center;"> <p>Switch</p>  </div> <div style="text-align: center;"> <p>Switch</p>  </div> </div>	<p>Two types of <i>switches</i> are available to activate or deactivate the inclusion of a variable by assigning a converter with it (takes on a value of 0 or 1).</p>
	<p>These <i>buttons</i> have been used for navigation in the model and are linked to various interface pages. The other use of these buttons has been to link and execute certain standard options such as Run, Reset, Pause etc.</p>
	<p>These <i>display tables</i> allow results to be populated in value format as opposed to graphically and allow for comparative runs. This allows data to be exported to MS Excel.</p>
	<p><i>Input table</i> – this allows a user to input/ change a list of variables and recalculate outputs.</p>
	<p><i>Graph pads</i> allow 5 variables to be displayed at a time but each one has multiple pages which can also be populated with more variables.</p>

Source: iSee Systems (n.d.)

For this study, the model development and design of the Short-term Electric Vehicle Simulator (STEVsim) is explained in Chapter 4 and the long-term Electricity Strategic Battery Electric Vehicle (E-StratBEV) model in Chapter 5 with the detailed modules, structures and parameters chosen.

### **3.3.6 Validation and Policy Insights**

Model validation can be defined (Board of Governors of the Federal Reserve System, 2011) as a “*set of processes intended to verify that models are performing as expected, in line with their design objectives and business uses*” or “*substantiation that a computerized model within its domain of applicability possesses a satisfactory range of accuracy consistent with the intended application of the model*”; a process which should be continued on an ongoing basis after implementing it, to keep track of previously identified limitations and any new ones which may emerge.

In this step, the final validation of the model is carried out, and includes conceptual and theoretical model validity, model verification, operational validity and empirical data validity (Sargent, 2013). Besides the work group members, any internal and external parties with an interest in the model are contacted to run through the model scenarios and calibrate according to experience and new information which may emerge, a process which allows for theoretical and empirical consistency checks (Sterman, 1984; Qudrat-Ullah, 2005). Empirical consistency includes comparing the simulation results to historical data and ensuring closeness of fit. Validation is also carried out by evaluating other models, results and assumptions on related work and comparing the project results.

### **3.3.7 Final Model Handover**

The model handover stage is a formal step to ensure that the simulation results are checked against the original scope of the project and have been completed. Various training sessions are arranged with the model owner to ensure independent running of the model. The handover stage is officially minuted and signed off by the system dynamicist and the customer.

### **3.3.8 Model Maintenance and Updates**

Post the handover stage, the customer generally identifies additional minor model changes or additions which could enhance the optimal running of the tool.

## **3.4 Summary**

The adapted system dynamics modelling processes, which included elements of group model building necessary for strategy implementation (Scott, Cavana, & Cameron, 2015), is argued to be an effective and rigorous modelling process for the

practical development and implementation of system dynamics tools for use in an electricity utility.

In this chapter, the extension from completed system dynamics models into the implementation and execution for sustainable scenario analysis was explained. The development of a system architecture map, a model boundary chart and causal loop diagrams supported the contextualisation of the focussing problem and assisted in framing the modules developed in the model.

Extensive preliminary data analysis into the BEV data and the electricity load data required two different simulators with different timeframes. A short-term system dynamics simulator (STEVsim) was required to allow an understanding of the hourly trends for electricity demand and vehicle charging times, before using any statistical empirical data for the long-term E-StratBEV.

For the STEVsim, to be conservative, the electricity load profile for June 2015 was used (highest monthly electricity demand in that year) and the BEV charging and consumption profile for July 2015 (highest electrical energy demand in that year) was used. Overall, for the majority of drivers, BEV Level 2 charging increased in the 2<sup>nd</sup> year, possibly linked to insufficient charging infrastructure, namely: not enough super chargers close to residential areas. The mobility trends indicated that if the BEVs were not being used, they were being overcharged, perhaps in an attempt to overcome some of the usual range anxiety highlighted by BEV drivers.

A significantly higher total mileage of the BEVs was observed on weekdays for commuting as opposed to weekend travel. It could be that commuters had longer distances to travel on weekends and preferred the use of their own vehicles thus distances travelled decreased as reflected by the logged data.

The average daily distance for the BEVs was 71 km, which was used for calculation purposes in the models (STEVsim and the E-StratBEV). The average daily fuel consumption was determined to be 21 kWh per 100 km.

## Chapter 4: Short-term Simulator (STEVsim)

---

### 4.1 Overview

To complete the research objective, which required an understanding of the impact of BEV charging requirements on the daily electricity demand load profile, it was necessary to develop a short-term simulator (STEVsim). The intention with the STEVsim was also to understand the data and any short-term patterns of behaviour that would help with framing the longer term strategic simulator to address the remaining research objectives. Chapter 4 looks at the impact of BEVs on the daily electricity demand profile, and related carbon emissions on an hourly resolution for a period of one month, using system dynamics software.

### 4.2 Defining the System Boundary for STEVsim

For this study, the vehicles under consideration were limited to passenger vehicles<sup>9</sup> in the residential sector. The impact of BEV charging requirements on the daily electricity demand in the residential sector were determined, and the associated carbon emissions calculated for the electricity and transport sectors. Figure 4.1 shows the average number of new passenger vehicle sales (excludes minibuses, buses, motor cycles, bakkies/loading vans, and trucks) per month for a particular year in South Africa (eNatis, 2018). Total new passenger vehicle sales in South Africa reached a high of 39,215 units in August 2006, with an average monthly figure of 40,130 passenger vehicles for that year (10% of the total average monthly registered number of passenger vehicles for that year), as reported by the National Association of Automobile Manufacturers of South Africa (NAAMSA, 2017). BEV substitution of ICEVs was then set as a percentage of the new passenger vehicle sales.

The daily distance of 71 km (monthly total of 2,130 km per month), obtained from the data analysis, was used to calculate the BEV charging requirements for the month. The charging of BEVs was assumed to be 100% from energy sent out from coal fired power generation for each month in year 2015 (due to Eskom's current coal heavy base) (Eskom, 2017). The average unit energy sent out (MWh) by a coal fired station in South Africa was kept at an average of 302,167 MWh based on the current coal fleet

---

<sup>9</sup> A passenger vehicle is a road motor vehicle, excluding a motor cycle, intended for carrying passengers and designed to seat no more than 9 people including the driver (UNECE, 2003).

capacity. Due to the short modelling timeframe of one month for the STEVsim, the degradation of BEV batteries and drops in fuel efficiency over time was excluded.

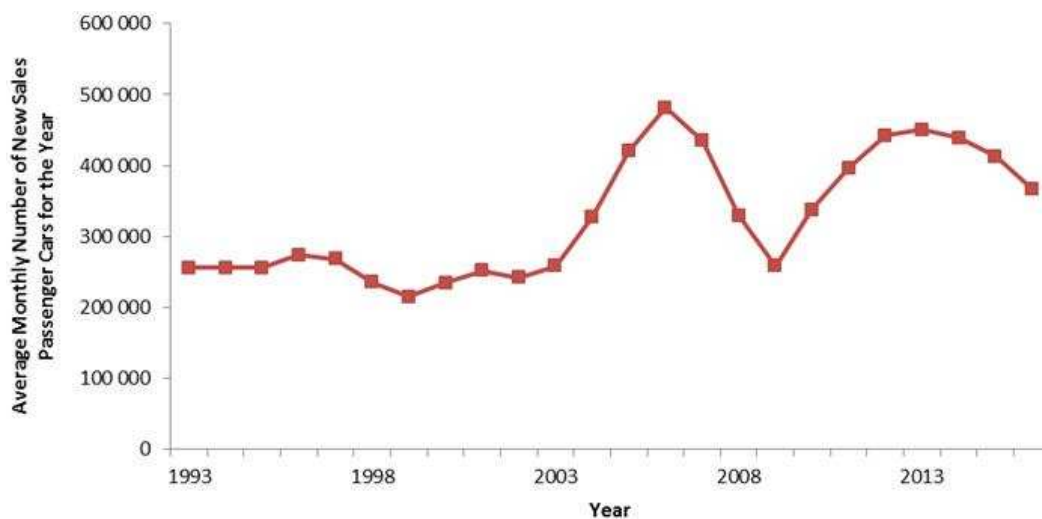

**Figure 4.1: Average Monthly Number of New Passenger Vehicles Annually**

Source: eNatis (2018)

### 4.3 Model Structures

The STEVsim was developed using iSee STELLA, and included the following modules:

- Electricity generation capacity,
- Electricity demand,
- BEV charging, and
- Carbon emissions.

#### 4.3.1 STEVsim Electricity Generation Capacity Module

The electricity generation capacity model structure to calculate the fraction of coal fired generation in the Eskom supply mix for 2015 used a total of 46,154 MW, of which Open Cycle Gas Turbines comprised 2,409 MW, Nuclear was 1,860 MW, Hydro was 600 MW, Pumped storage was 1,400, wind was 500 MW and imports were 1,500 MW. This meant that the coal fraction used for calculations was 0.79 (Eskom, 2017). STEVsim did not include the detailed differences in performance attributes and auxiliary power, which the strategic long-term simulator would require due to decommissioning schedules and the incorporation of the future build plan from South Africa's Integrated Resource Plan (DOE, 2016).

### 4.3.2 STEVsim Electricity Demand Module

The daily electrical energy sent out in MWh per month, and daily residential electricity demand (MW), were exogenous and the time series data was imported into converters. The monthly BEV charging requirements were calculated by multiplying the target number of BEVs to the average monthly BEV charge (obtained from the data analysis process in Chapter 3). Figure 4.2 was built to allow a user to select any month in the 2015 year for scenario analysis, in this case the electricity demand.

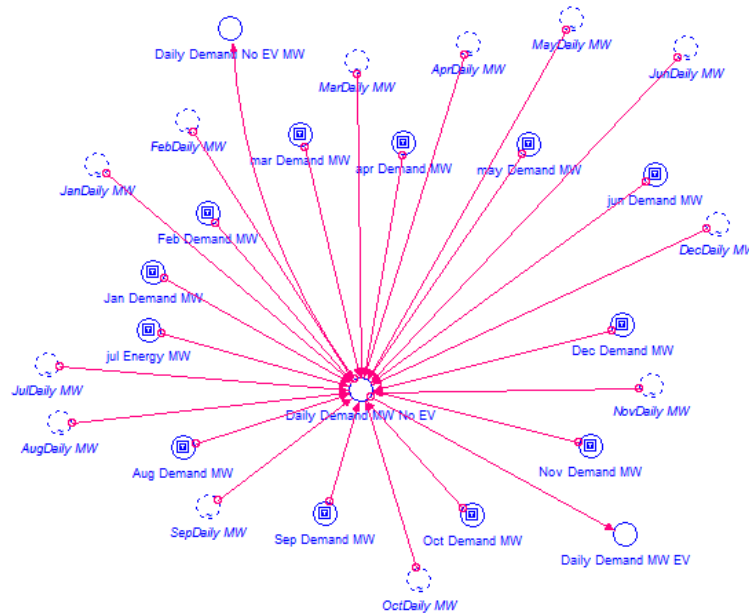

**Figure 4.2: Model Structure – Daily Electricity Demand**

Conditional statements allowed the selection of a specific month in the model structure. This was enabled on the user interface by creating a push button, linked structure, which allowed one unique selection. Similar conditional statements were built into the model structures for the daily:

- Energy sent out by coal fired power stations (MWh per month),
- Daily residential electricity demand (MW per hour per day), and
- Monthly BEV electrical charging energy required (MWh per day).

The total electrical energy required for charging the BEVs in a month was calculated using an initial stock value of zero which accumulated the daily electrical energy charge over a period of a month, represented by the following integral Equation 4.1 with an initial stock value of zero.

$$BEV\ Charge(t) = Daily\ Demand(t-dt) + Daily\ Demand\ Inflow * dt$$

Equation 4.1



Similar stocks were developed to accumulate the daily value over a month for:

- Energy sent out from coal fired electricity generation (MWh per month),
- Charging required (MWh per day) by BEVs, and
- Carbon emissions (ktons per month) generated in the energy sector and the transport sector.

#### 4.3.3 STEVsim Emissions Module

The carbon emissions generated from the coal fraction of the generation mix was calculated using Equation 4.2, where the average CO<sub>2</sub> emissions per MWh sent out was 0,924 ton per MWh (EPRI, 2010).

$$\text{Carbon emissions}_{Gx} (\text{tons}) = \text{Average CO}_2 \text{ emissions per MWh Sent Out (ton/MWh)} \times \text{Energy Sent out (MWh)} \quad \text{Equation 4.2}$$

The carbon emissions model structure for ICEVs is shown in Figure 4.3, where the stocks are the net accumulation of CO<sub>2</sub> emissions for petrol and diesel ICEVs.

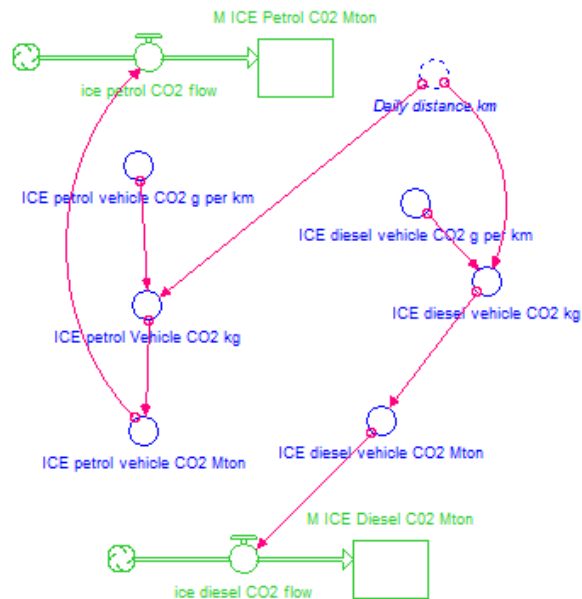

**Figure 4.3: Model Structure – Carbon Emissions from ICEVs**

Data was obtained on the average carbon dioxide emissions for an ICEV and set at 153.77 g/km for a petrol vehicle and 119.6 g/km for a diesel ICEV (Snyman, 2017). Vehicle population statistics in South Africa indicate that 80% of vehicles are petrol and

20% are diesel fuelled (ArriveAlive, 2017). The fractions for diesel and petrol ICEVs were, therefore, set at 0.2 and 0.8 respectively. Equation 4.3 was used to calculate the total emissions in the transport sector, and then the value was converted to ktons.

$$Carbon\ emissions_{ICE}(g) = (Distance\ travelled\ (km) \times (Vehicle\ Fuel\ Type)(g/km))$$

Equation 4.3

### 4.4 Interface Design & Development

In order to engage with the model, interfaces had to be developed to run scenario and sensitivity analyses. The interfaces include controls for the energy demand scenario analysis (Figure 4.4) and for the environmental aspects (Figure 4.5).

On the ENERGY DEMAND engagement platform, Figure 4.4, the graph on the top right, displays a comparative graph with the daily BEV charge. The bottom right graph set displays the daily values for the BEV charging requirements and the residential electrical energy demand without BEVs, based on which month's trends are being analysed (push buttons are activated for the data for that month).

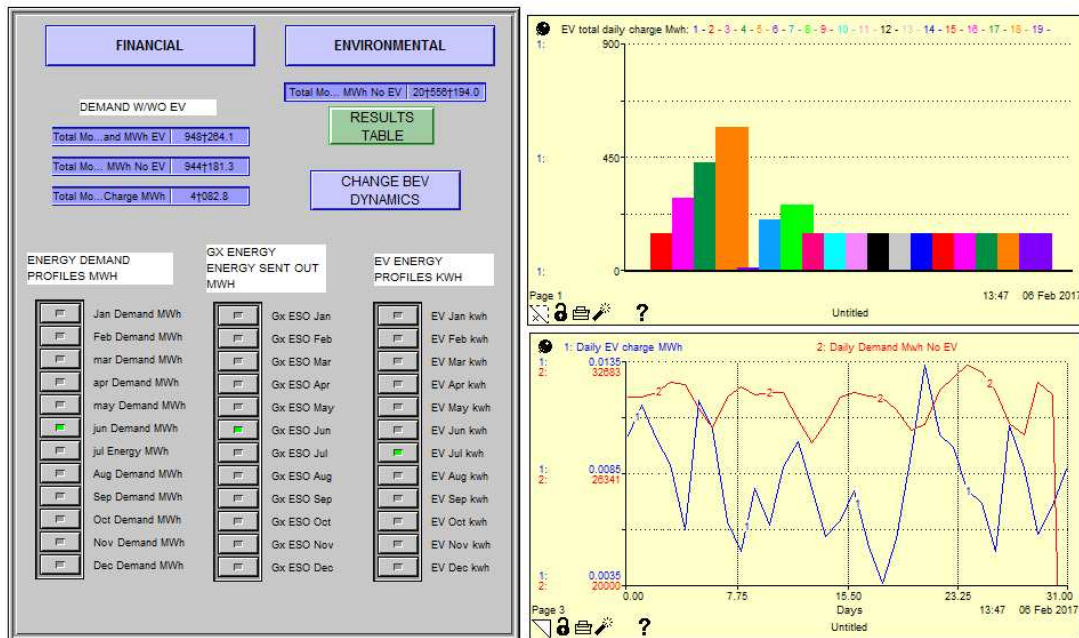

Figure 4.4: Model Interface – STEVsim: Energy Demand Dynamics

On the ENVIRONMENTAL interface shown in Figure 4.5, the user can view the impact of changing the target number of BEVs for substitution with new sales ICEVs for the month, and observe the impact on the daily emissions in the transport sector as well as

the carbon emissions in the energy sector due to additional energy sent out from the coal generation process.



Figure 4.5: Model Interface – STEVsim: Environmental Dynamics

## 4.5 Scenarios

The scenarios involved 3 different BEV substitutions of ICEVs. The expectation as perceived by the Energy Research Centre at the University of Cape Town, based on various government plans policies and programs, as well as stakeholder perception, is that there would be 4,000 electric vehicles per annum through the Public Procurement Program and 1,500 private electric vehicles purchased (Dane, 2013); hence a monthly penetration of approximately 458 BEVs. Based on South Africa's fraction of 0.05 of the world's GDP, Jordaan (2016) indicated a potential of 0.5% EV affordability in South Africa, which approximates to 100,000 EVs by the year 2020 (approximately 1,700 new BEV sales each month over 5 years). The Government's Green Transport Strategy, published by Department of Transport, plans for 2.9 million electric vehicles by 2050 (DOT, 2016), which is about 7,323 new BEV sales a month from 2017 until 2050.

The monthly forecasts from these sources are diverse, so for purposes of choosing BEV targets and understanding the impact of varying BEV penetration rates on daily electricity demand and emissions, a per cent substitution of the maximum monthly ICEV new vehicle sales was used. Table 4.1 is thus based on the Public Procurement

Program (PPP Scenario) of 458 BEVs; using GDP as a parametric (GDP Scenario) of 1,700 BEVs; and using the Department of Transport's Green Transport Strategy would imply 7,323 EVs a month (DOT Scenario).

**Table 4.1: STEVsim Scenarios for BEV Monthly Market Penetration**

Scenarios	Base-Case	PPP Scenario	GDP Scenario	DOT Scenario
BEVs penetration rate as a % of the maximum monthly average New Vehicle Sales	0%	1.14%	4.24%	18.25%
BEVs in a month	0	458	1,700	7,323

#### 4.6 STEVsim Results

Figure 4.6 illustrates the daily electricity consumption (MWh) for the different scenarios, when ICEVs are substituted with BEVs, based on an average daily travelling distance of 71 km; comparing the trend with the daily average residential consumption in a month.

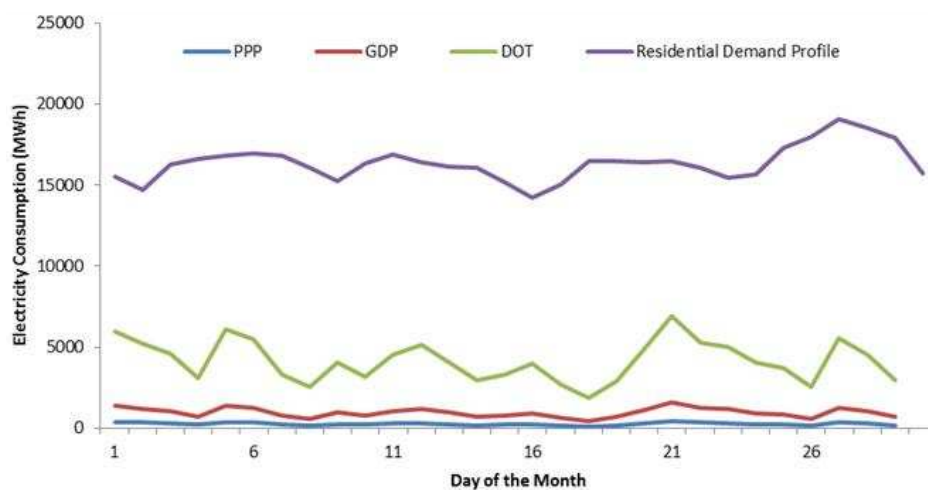

**Figure 4.6: Daily Electricity Consumption Profiles**

The PPP scenario (458 BEVs) resulted in a 1.58% increase in the residential electricity consumption and a 0.04% increase in the overall national monthly electricity consumption (residential plus all the economic sectors); the GDP scenario (1,700 BEVs) resulted in a 5.86% increase in the residential electricity consumption and a 0.13% increase in the national monthly electricity consumption, while the DOT scenario (7,323 BEVs) resulted in a 25% increase in the monthly residential electricity consumption, and a 0.57% increase in the national monthly electricity consumption.

The average unit energy sent out by a coal fired station in South Africa is 302,167 MWh per month. Figure 4.7 shows the monthly BEV electrical energy as a percent of a coal fired power station unit, and compares that to the overall electricity consumption increase due to charging requirements by varying monthly BEV substitutions, per month. For the most aggressive case, the DOT scenario (7,323 new BEVs for the month), this was an equivalent of 1.37% of a coal fired unit's energy sent out per month. The low penetration PPP scenario was 0.09% of a single coal fired unit's energy sent out per month.

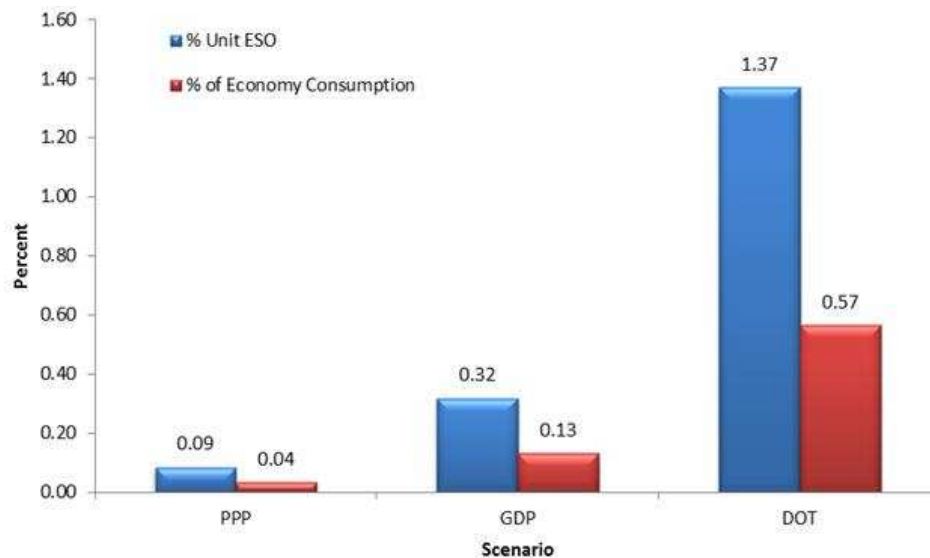
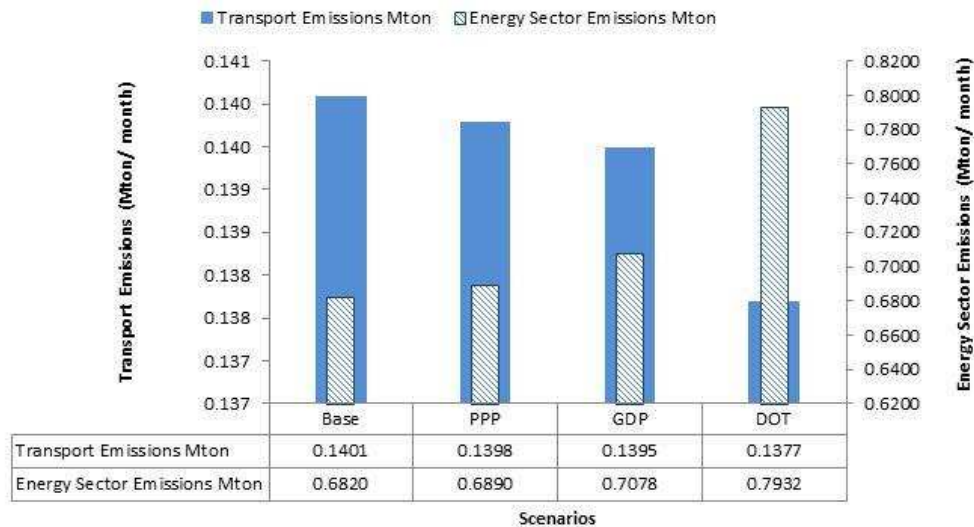

**Figure 4.7: Additional Electricity Required for BEV Charging per Month**

Figure 4.8 shows the carbon emissions in the energy sector and in the transport sector in a month. There was an average of 407,157 registered vehicles per month in 2006 when there was the highest recorded average number of monthly passenger vehicles. The carbon emissions for the registered (excluding the new passenger vehicles per month), travelling a daily distance of 71 km per day, would be about 0.1275 Mtons for the month.

The monthly registered passenger vehicles with a 100% ICEV fleet of new passenger sales produced about 0.1401 Mton per month carbon emissions in the transport sector, decreasing by 0.21% for the PPP scenario, 0.43% for the GDP scenario and 1.71% for the DOT scenario.

The energy sector carbon emissions were in the order of 0.680 Mtons per month without BEV charging requirements. The energy sector increased by 1.02% for the PPP scenario, by 3.79% for the GDP scenario and by 16.31% for the DOT scenario.



**Figure 4.8: Comparison of Carbon Emissions in the Transport and Energy Sectors**

#### 4.6 Summary

The preliminary data analysis showed that the hourly empirical charging data for the BEVs was inconsistent and could not be used to forecast the impact on the peak electricity demand profiles. However, after the development and scenario analysis of the STEVsim, the daily BEV electricity demand values for a month, for the various BEV market penetration rates provided an indication of the possible load on residential electricity consumption possibly expected. For municipalities to plan for additional electricity demands due to BEVs, a provincial breakdown of the impact of BEVs on the residential demand curves would have to be carried out, however, preliminary work in this chapter indicates that the impact on residential electricity consumption may be significant if there is a monthly BEV sale of 7,323 vehicles, assuming all charging is done at home.

Based on the STEVsim results, it appeared favourable to support the BEV substitution of ICEVs as part of environmental drives to reduce carbon emissions nationally although the impact was small with the number of BEVs used in these scenarios (a decrease of 1.71% for the most aggressive DOT scenario).

Since the power stations differ in performance attributes, auxiliary power consumption, and net energy produced, the overall performance measures and total electricity generated needed to be determined more accurately using weighted average performance formulas with the current generation capacity mix and the future build, not just a high level estimate of fraction of the total mix as was used in the STEVsim.

The future build needed to accommodate a possible scenario of a renewables heavy supply mix even if the country's current generation mix is heavily weighted with a coal base-load and this could only be done by building in a more detailed electricity supply module for the E-StratBEV.

Although the STEVsim provided an easy way to analyse and run calculations for results, the system dynamics software was not necessary since the causal variable relationships, for this scope of work, were linear, and the computations could have been done as effectively using MS Excel.



# Chapter 5: Model Structure for E-StratBEV

---

## 5.1 Overview

The research objective covered in this chapter includes the development of a mathematically sound, system representative model, using a system dynamics modelling approach. The Chapter explains the structure and development of the long-term strategic E-StratBEV model to determine the provincial and national affordability of BEV purchases using average disposable income profiles. The E-StratBEV was made up of various modules and sub-modules so that scenario runs and sensitivity analysis could be done in the next chapter to address all the research objectives including the number of BEVs which could be expected nationally and provincially, together with the related electricity consumption and carbon emissions expected.

## 5.2 Context for the E-StratBEV

From the literature review, preliminary analysis and the development of the STEVsim, the following information emerged, which was necessary for the development of the E-StratBEV:

- The drivers for BEV adoption are numerous and include tax incentives for consumers, increased charging infrastructure, longer driving ranges (with reduced “range anxiety”), lower purchase prices, fuel efficiency, speed and acceleration, vehicle variety and reputation effects, as well as policy mechanisms linked to climate change mitigation. These drivers vary for countries even within the same continental region and dominate at various intensities and orders of priority (Bessenbach & Wallrapp, 2013). This is important since South Africa cannot be assumed to have the same risks and prioritisation order for BEV drivers as those identified in other countries.
- No peer reviewed journal articles or BEV roadmaps exist for South Africa for long-term BEV forecasts (up to 2050), especially not on a provincial level. However, there are BEV forecasts based on work captured in reports from institutes, such as the Council for Scientific and Industrial Research (Bischof-Niemz, et al., 2017), Energy Research Centre (Dane, 2013; Grant, 2014) and speculative articles (Jordaan, 2016).



- If consumers have more disposable income, the number of vehicles per household increases (Van Heerden, 2016). If economic activity increases, there is a positive correlation with the purchase of luxury goods (Reyneke, Sorokáčová, & Pitt, 2012) such as BEVs. Globally, there are several BEV forecasts and expectations of BEV market penetration rates. This study looks at ICEV affordability based on disposable income on a provincial level and within income groups and relates the trends to BEV forecasts for the South African provinces.

Based on the causal loop diagram, the system architecture map, the literature review and the system data analysis, it was also expected that the drivers impacting the adoption rate of BEVs would introduce a secondary impact that results in an additional number of BEVs to the targets in the scenarios for the E-StratBEV. These impacts would require the development of stock-flow-feedback model structures in the E-StratBEV, to ensure alignment with patterns of behaviour that would be consistent with biophysical constraints in the long-term, noting that complex systems are dynamic and most often non-linear if causal relationships and feedback mechanisms are to be considered (Vaneman & Triantis, 2003). The E-StratBEV made use of the logistics curve equation specified in Meyer (1994), shown in Equation 5.1, which allows for asymptotic conversion to lower values, by specifying a negative value for  $U_1$ , or a positive stabilizing non-zero value by retaining a positive value for  $U_1$ .

$$P(t) = U_0 + \frac{U_1}{1 + \exp[-c(t - t_0)]} \quad \text{Equation 5.1}$$

where  $P$  is the dependent variable and  $P(t)$  is a function of time  $t$ ;  $U_0$  is the zero offset;  $U_1$  is the ultimate increase (or decrease) above  $U_0$ , modelled using a S-curve;  $c$  is a growth rate exponent that determines the maximum slope of the S-curve; and  $t_0$  is the time at which the maximum slope is reached (inflection point).

The timeframe for the E-StratBEV simulator started from 1993 to accommodate the historical Eskom power generating supply mix and ends at 2050 to align with South Africa's latest Integrated Resource Plan (DOE, 2016). Empirical data (e.g. BEV charging and electricity consumption profiles, distances travelled etc.) was obtained from the Eskom three-year BEV study (Langley, 2015).

### 5.3 Module Development for the E-StratBEV

The iSee Stella software was used to develop the modules of the E-StratBEV, which included the sub-modules shown in Table 5.1.

**Table 5.1: Modules and Sub-modules in E-StratBEV**

<b>Module</b>	<b>Sub-module</b>
5.3.1 Electricity Generation Capacity	<ul style="list-style-type: none"> <li>• Installed electricity capacity with performance factors</li> <li>• Energy sent out</li> <li>• CO<sub>2</sub> emissions based on the supply mix</li> </ul>
5.3.2 Economy	<ul style="list-style-type: none"> <li>• GDP and causal linkage with electricity consumption</li> <li>• Residential electricity consumption per province</li> <li>• Economic sector electricity consumption per province</li> <li>• Gini coefficient linked to residential consumption</li> </ul>
5.3.3 Income	<ul style="list-style-type: none"> <li>• Households per province</li> <li>• Real disposable income</li> <li>• Disposable income per household per decile</li> </ul>
5.3.4 ICEVs	<ul style="list-style-type: none"> <li>• Actual ICEVs per province with scrappage</li> <li>• Transport Sector Emissions and fuel efficiency</li> <li>• Affordable ICEVs per province based on disposable income</li> <li>• ICEV correction factor</li> </ul>
5.3.5 BEVs	<ul style="list-style-type: none"> <li>• BEV distribution per province depending on the parameter (GDP fractions or disposable income fractions or ICEV fractions or population fractions)</li> <li>• BEV Adjustment Factor to determine expected BEVs due to drivers</li> <li>• Linkage of BEV drivers such as purchase price (includes import taxes and battery costs), range anxiety, charging infrastructure and reputation effect.</li> <li>• BEV charging electricity requirements after substitution of ICEVs</li> </ul>

#### 5.3.1 Electricity Generation Capacity Module

The structures in this module were based on previous work by Nel (2011) and Booyens & Pillay (2016). The generation capacity module calculated the energy sent out (MWh) and comprised of a sub-module to calculate the *current* generation mix and a sub-module to calculate the *future* generation mix.

The *current* power generation supply sub-module included capacities for the Eskom coal power plant fleet, nuclear, hydro-pumped storage, gas cycle turbines, hydro-electric power, and wind power (Eskom, 2017). The *future* power generation supply sub-module was based on two options for the generating supply mix.

Time series data for the first option for a coal heavy future capacity was aligned to the IRP 2016 (DOE, 2016) future plan while the second option for a renewables heavy future capacity was aligned to the CSIR scenario (Wright, Bischof-Niemz, Calitz, Mushwana, Van Heerden, & Senatla, 2017) where solar photo-voltaic (PV), wind and flexible power generators (e.g. gas, Concentrated Solar Plant (CSP), hydro, biogas) were seen as the cheapest new-build mix, with an assumption of no technical limitations to solar PV and wind penetration until 2050.

The reason for the two future supply mixes was to understand what the impact on energy and capacity reserve margin<sup>10</sup> would be with the additional electrical consumption from BEVs. Capacity is measured in MW and would measure the instantaneous power that a power plant can produce while the energy calculations refers to the actual power generated over a period of time and is expressed in MWh. Ideally, the generation fleet requires a capacity reserve margin of 15-20%. The reason for calculating the energy reserve margin and comparing it against the capacity reserve margin is due to the variation in energy outputs even from large capacity renewable generating sources (when compared to coal heavy generating supply mixes). Individual coal fired power stations differ in performance attributes, auxiliary power consumption, and net energy produced. The arithmetic average would not be a representative measure to evaluate the fleet performance of the generation power plants since the performance of small capacity stations would weigh equally compared to large capacity stations, hence the overall performance measures and total electricity generated were determined using weighted average performance formulas (Merven, Stone, Hughes, & Cohen, 2012), shown in Equation 5.2.

$$M = \frac{\sum m_i c_i}{\sum c_i} \quad \text{Equation 5.2}$$

where  $i$  is the power station,  $M$  is the power station's capacity weighted average of performance measure  $m$ ;  $m_i$  is the performance measure for the power station (e.g. load

---

<sup>10</sup> Reserve margin is the (capacity minus demand)/demand where capacity is the expected available supply and demand is the expected peak demand.

factor); and  $C_i$  is the capacity of station,  $i$ . The time series performance factors were obtained from Eskom’s Generation division (Van Der Merwe, 2014), and included planned and unplanned outage allocations, as well as the stations auxiliary consumption.

These performance factors were used as inputs in arrayed dimensions and used to determine the level of the generation installed capacity stock (Figure 5.1) for each of the power stations, shown in Figure 5.2.

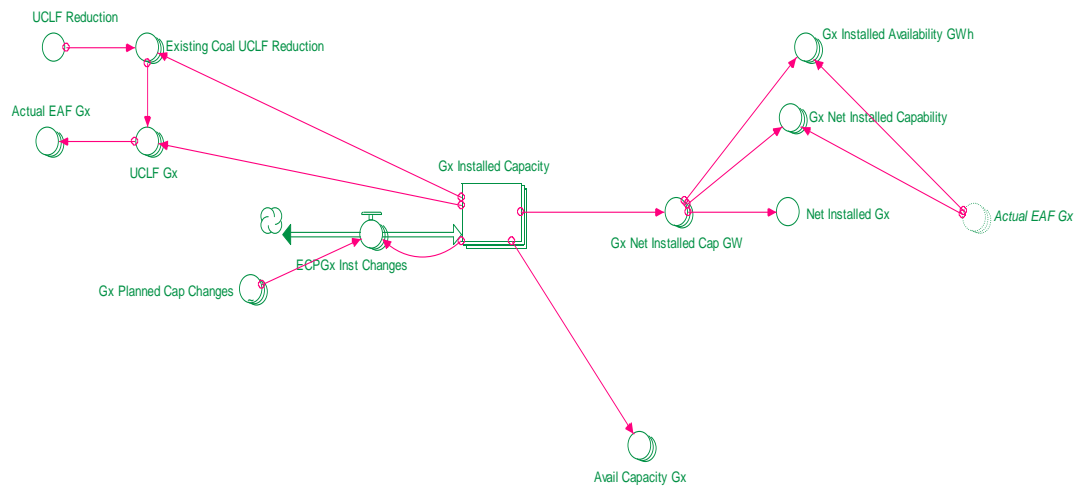

**Figure 5.1: Supply Mix of Existing Generation Capacity**

The time series performance factors were used to calculate the energy availability factor using Equation 5.3 with Eskom’s target for EAF 80% (Eskom SOC, 2017).

$$EAF = 1 - PCLF - UCLF - OCLF \tag{Equation 5.3}$$

Where EAF is the Energy Availability Factor and measures the plant availability including planned and unplanned unavailability and energy losses not under management control, PCLF is the Planned Capability Loss Factor which measures the energy loss during the period due to planned shutdowns, UCLF is the Unplanned Capacity Loss Factor and measures the lost energy due to unplanned energy losses resulting from equipment failures and other plant conditions, and OCLF is the Other Capacity Loss Factor (not accounted for UCLF or PCLF).

Stocks were used to store the power station capacities (MW), using inflows of base load capacities. To calculate the energy sent out (ESO) by the power stations, Equation 5.4 was used.

$$ESO \text{ (GWh)} = \text{Installed capacity (MW)} \times EAF \times EUF \times \text{Hrs per year} \quad \text{Equation 5.4}$$

Where *EU*F is the Energy Utilisation Factor (measures the use of available energy), and the hours per year = 8,760 hrs.

Figure 5.2 shows the existing base load generating supply mix for Eskom.

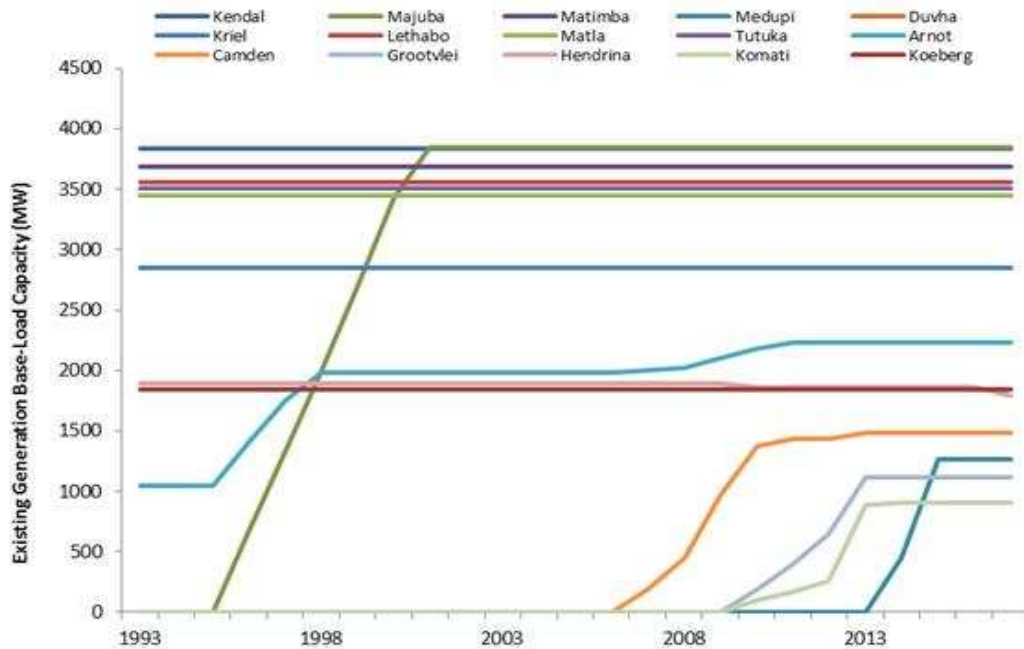

**Figure 5.2: Existing Eskom Electricity Supply (Base-load Capacity)**

Source: Eskom (2017)

The calorific value (CV) of coal, together with the heat rate (the heat input required to produce one unit of electricity – energy sent out ESO)) at the power station is required to calculate the coal consumption at the coal fired power stations. The energy sent out from the coal fired power stations was used to determine the CO<sub>2</sub> emissions using a carbon emission value of 924.4 kg per MWh energy sent out (EPRI, 2010).

Two types of merit order dispatch structures were developed to meet the energy demand. The first structure dispatches nuclear first, followed by renewables, then coal fired stations and then peaking plant (Nel, 2011). The second cascading dispatch logic structure is based on the power station with the highest thermal efficiency first, followed by the next highest (any unsupplied energy from the power stations is sent to future build coal fired power stations or to peaking stations) (Booyens, 2014). Structures

similar to Figure 5.1 in the current electricity generation base-load capacity sub-module were developed for:

- The existing peaking capacity sub-module such as open cycle and close cycle gas turbines, hydro pumped storage and hydro-electric, and
- The future generation supply mix sub-modules, one of which used a renewable heavy future supply mix and the other maintained a predominantly coal heavy supply mix.

Figure 5.3 is the Eskom committed base load capacity plan and factors in decommissioning of the coal fired power stations after a 50 year plant life.

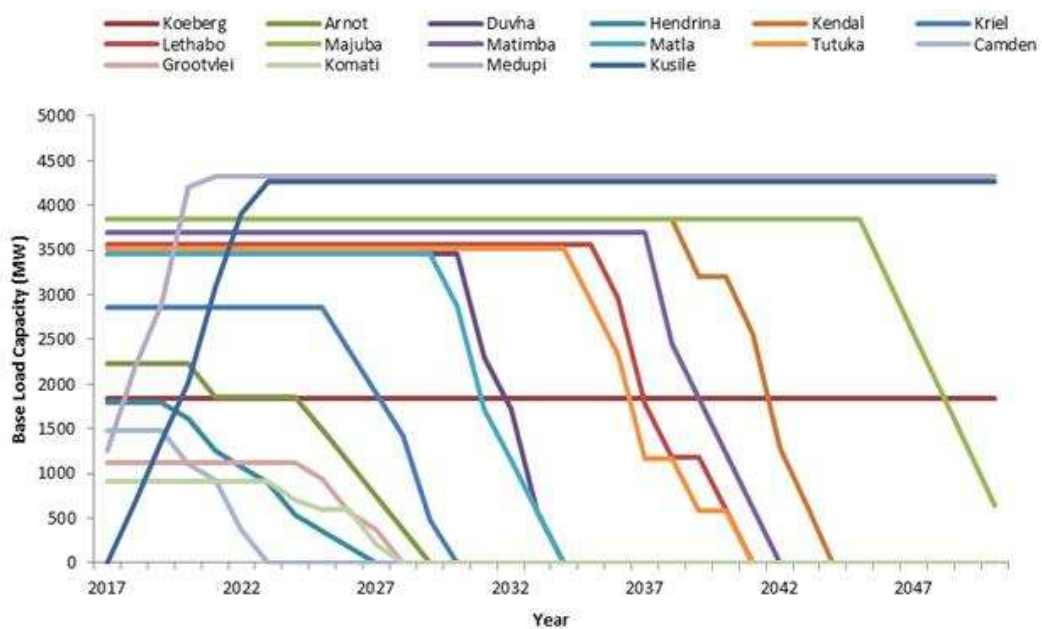

**Figure 5.3: Committed Eskom Base-load Future Supply Mix**

Source: VD Merwe A (2014)

Figure 5.4 is the Eskom committed peaking capacity plan used as inputs for the supply mix sub-module where the “DOE peaker” is the generating capacity controlled for despatch by Eskom’s National Control but not owned by Eskom.

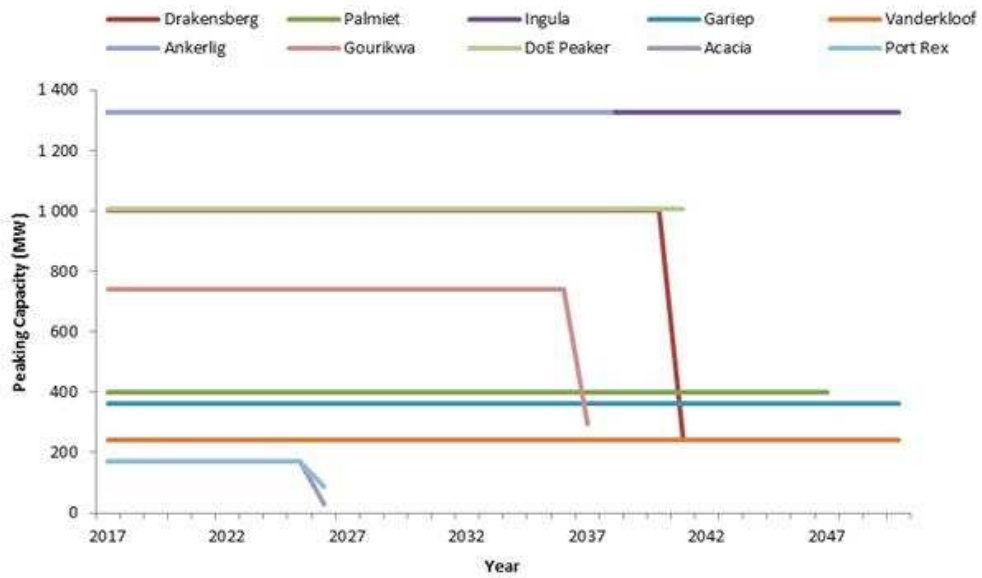

**Figure 5.4: Committed Eskom Peaking Supply Mix**

Source: VD Merwe A (2014)

For a coal heavy future supply mix, inputs shown in Figure 5.5 were added to the time series trends in Figures 5.3 and 5.4; and for the renewables heavy future supply mix, inputs from Figure 5.6 were added to the trends in Figures 5.3 and 5.4.

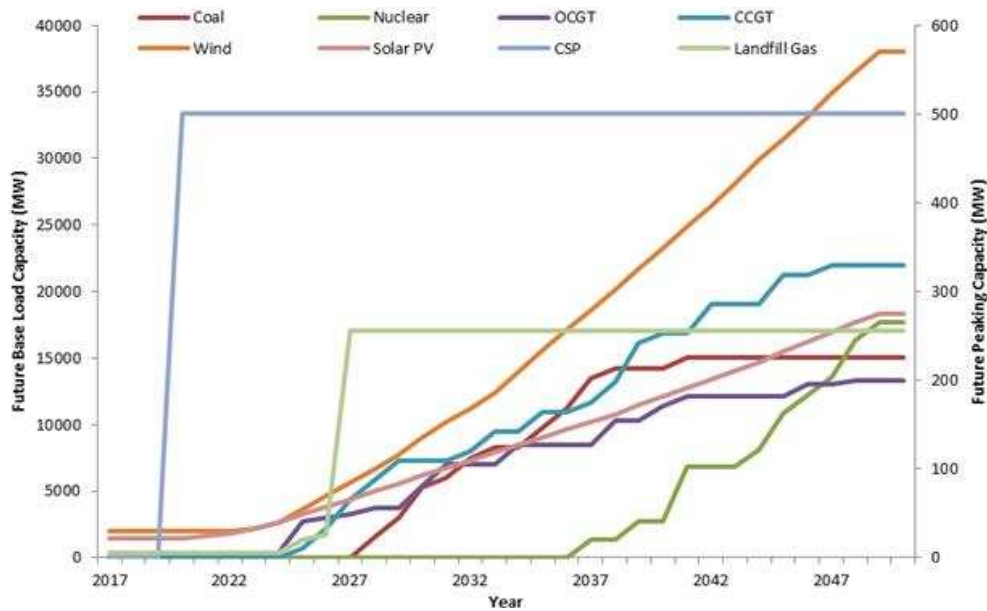

**Figure 5.5: Coal Heavy Future Supply Mix (Base-load and Peaking)**

Source: DOE, Integrated Energy Plan (2016)

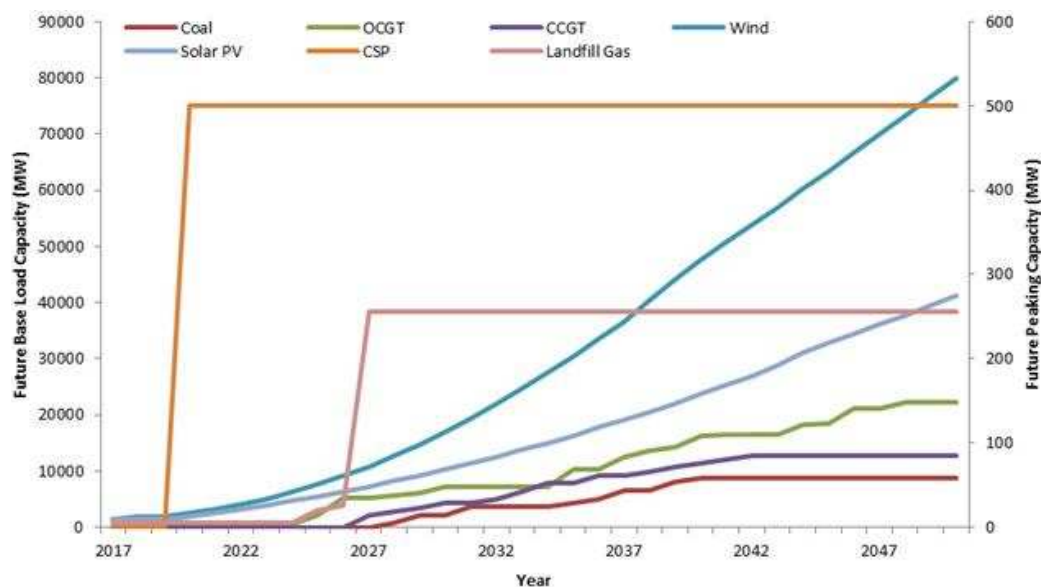

**Figure 5.6: Renewables Heavy Future Supply Mix (Base-load and Peaking)**

Source: Wright, Bischof-Niemz, Calitz, Mushwana, Van Heerden, & Senatla (2017)

### 5.3.2 Economy Module

The economy module is made up of the GDP sub-module, the economic sector electricity consumption sub-module, the residential electricity demand sub-module, causal mathematical linkages of electricity consumption with GDP and the Gini coefficient.

#### 5.3.2.1 GDP Sub-module

Part of the demand module included constructing a GDP sub-module (with the historical GDP data as exogenous inputs). Purchasing power parity provides a better comparison of real GDP compared to market exchange rates, since it considers constant value for a “basket” of goods and services. The base year used was 2010 (due to the national and European changes implemented in February 2013, which re-referenced short-term statistics and time series data from base year 2005 to 2010) (Botes, 2014; Van de Ven, 2015). Real GDP time series values (Stats SA, 2018) were uploaded into the converter displaying history (R million) in Figure 5.7. The structure allows the user to observe the percent year on year change in GDP but also to change the target value of the expected GDP at the end of the simulation time period together with the time period over which the target will be reached.



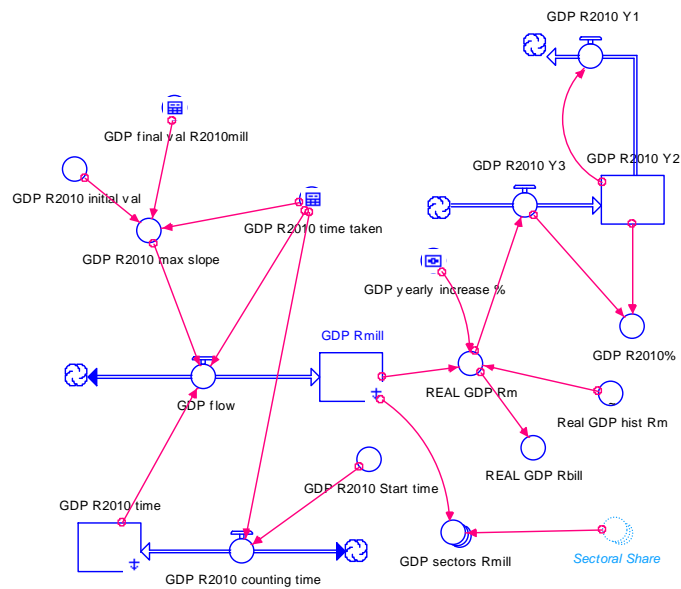

**Figure 5.7: GDP Sub-module**

The target GDP was set at a 2% constant annual growth based on South Africa’s National Treasury Budget Review (2017), to calculate the future growth from 2018 until 2050 (the end of the simulator timeframe).

The percentages used to calculate the future GDP for the economic sectors was kept at the 2016 values and are shown in Table 5.2 (Stats SA, 2018).

**Table 5.2: Economic Sector GDP Splits (2016)**

	<b>Economic Sector</b>	<b>Per cent of GDP (%)</b>
1.	Agriculture, forestry and fishing	2.41
2.	Mining and quarrying	8.26
3.	Manufacturing and Construction	18.06
4.	Services (includes Finance, real estate and business services, General government services, and Personal Services)	46.04
5.	Transport (includes Transport, storage and communication; Wholesale, retail and motor trade; catering and accommodation)	25.24
6.	Energy (Electricity, gas and water)	2.35

Source: Stats SA (2018)

After calculating the national GDP using 2010 as a base year, the *GDP per capita* was calculated by dividing the GDP stock by the population stock (with imported historic data from 1993 until 2016). The national GDP sub-module was then broken up into a provincial split based on the historical information shown in Figure 5.8 (Stats SA, 2017).

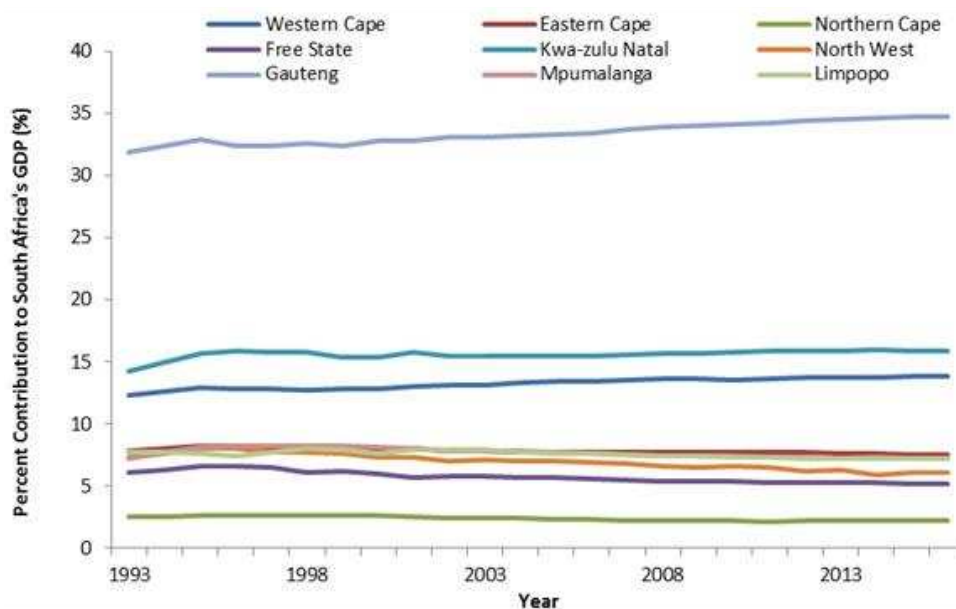
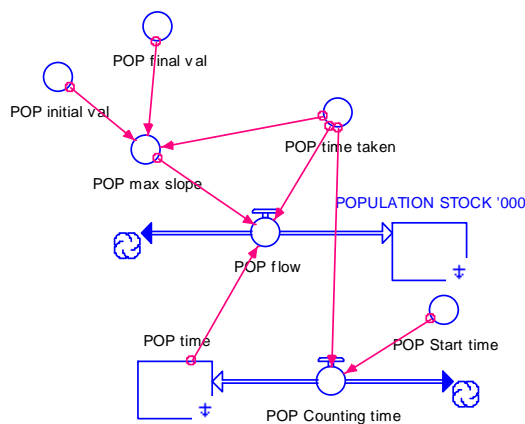

**Figure 5.8: Provincial Contributions to GDP**

Source: Stats SA (2017)

### 5.3.2.2 Electricity Consumption Sub-module

From 1993 until 2016, historical time series population data for the provinces was imported from the Provincial Demography Database, managed by the Department of Water & Sanitation (DWA, 2017). A logistic S-curve equation was used to determine the population growth from 2017 until 2050, using a medium growth target of 63.4 million estimated by the World Population Prospects (2013) and an initial stock value of 37.47 million people in 1993. The model structure is shown in Figure 5.9. A population target with an S-curve was used instead of births and deaths flowing into a population stock since the population target could be validated against a known forecast as far into the simulation timeframe as 2050 and changes to births and deaths were not required for any other calculations or structures.



**Figure 5.9: Population from 1993 until 2050**

The residential consumption<sup>11</sup> sub-module, shown in Figure 5.10, was developed to determine the national residential electricity consumption linked to GDP and income distribution. The additional electricity charging requirements based on the BEV targets were then added to the residential electricity consumption. The structure is based on mathematical relationships and equations established through previous work by Nel (2011) to link GDP to residential consumption, and Pillay et al. (2014) to link residential consumption to the Gini coefficient (representing income distribution).

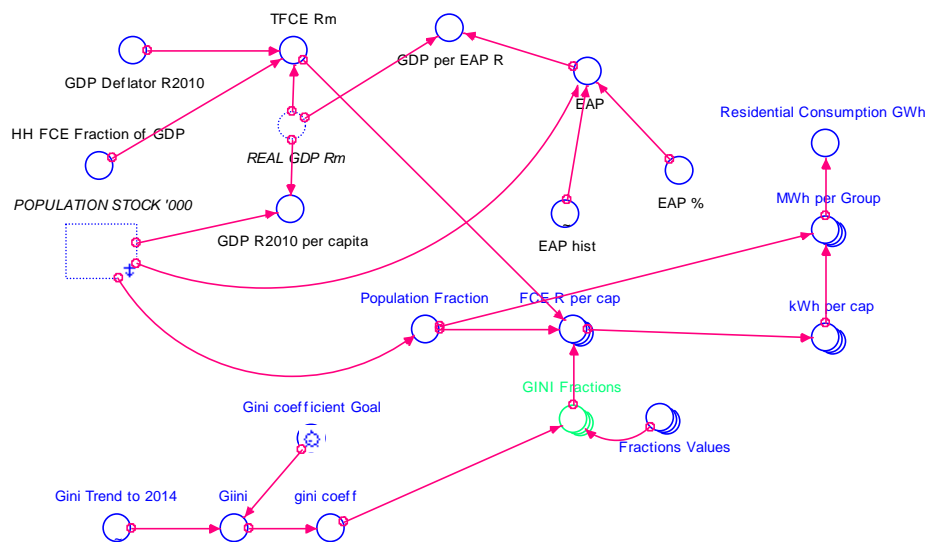

**Figure 5.10: GDP linked to Residential Electricity Consumption and the Gini coefficient**

<sup>11</sup> Electrical power is expressed in megawatts (MW) and reflects the output from the power stations while the energy consumed from electricity generation is measured megawatt-hours (MWh). The total residential electricity consumption in MWh was summed over the simulation timeframe (1993-2050).

The percentage provincial contribution fractions to the national population (DWA, 2017) were used to determine the GDP per capita distributions per province.

The residential electricity consumption per capita and residential electricity consumption per income group was calculated on a disaggregated provincial level (Figure 5.11). The electricity consumption was also calculated per economic sector. The economic sectors were put into arrays and include the same categories used for the GDP sectoral breakdowns: Agriculture, forestry and fishing; mining and quarrying; manufacturing and construction; services; transport; and energy (electricity, gas and water). The model structure for the economic sector electricity consumption per province is shown in Figure 5.12 and calculated with Equation 5.6.

$$\text{Provincial Electricity Consumption per Sector (GWh)} = (\text{Arrayed})\text{GDP} \times (\text{Arrayed})\text{Electricity Intensity} \quad \text{Equation 5.6}$$

Thereafter, the total electricity consumption for each province was obtained by adding the residential consumption with other provincial economic sector consumption.

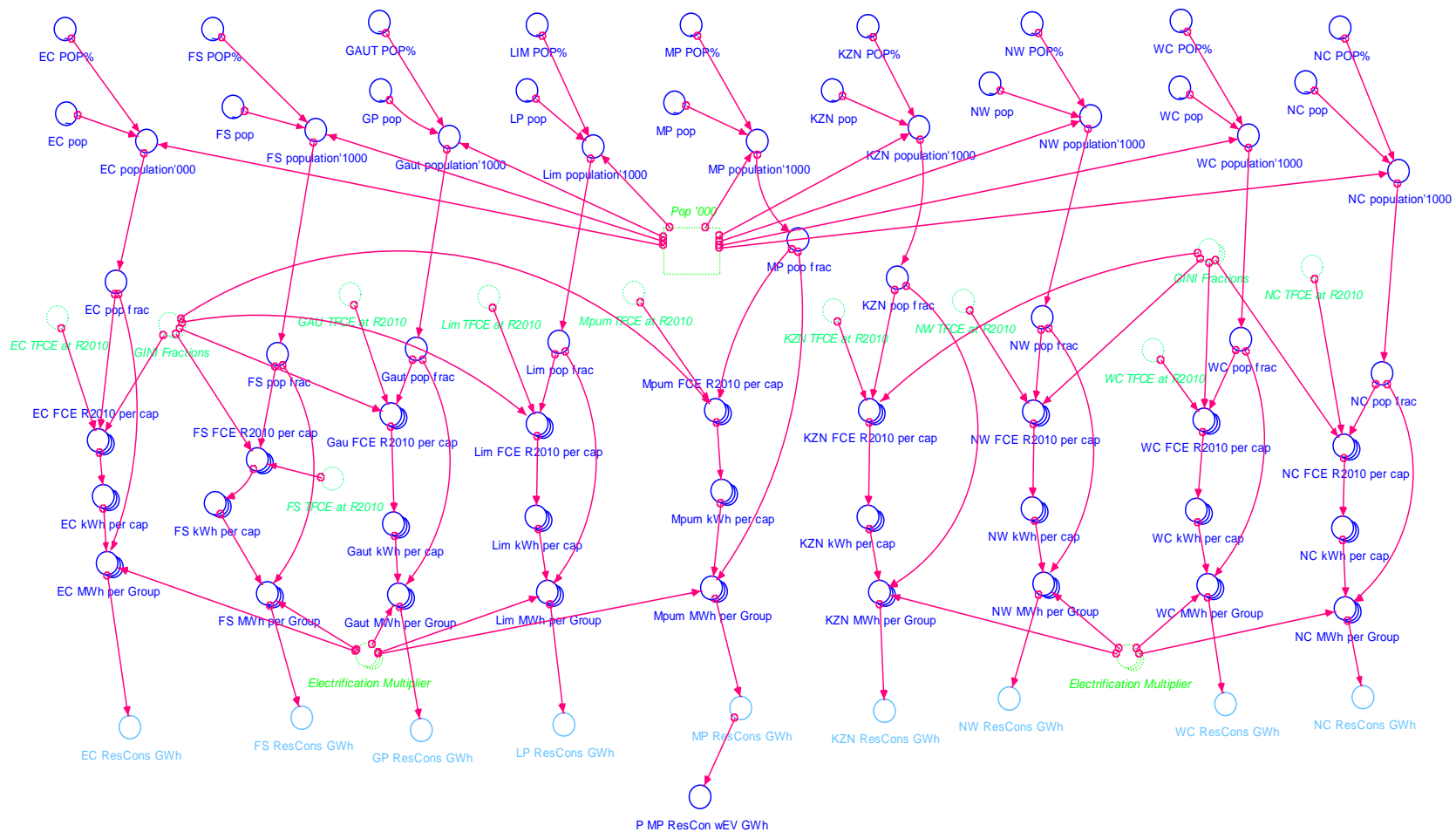

**Figure 5.11: Provincial Residential Electricity Consumption**

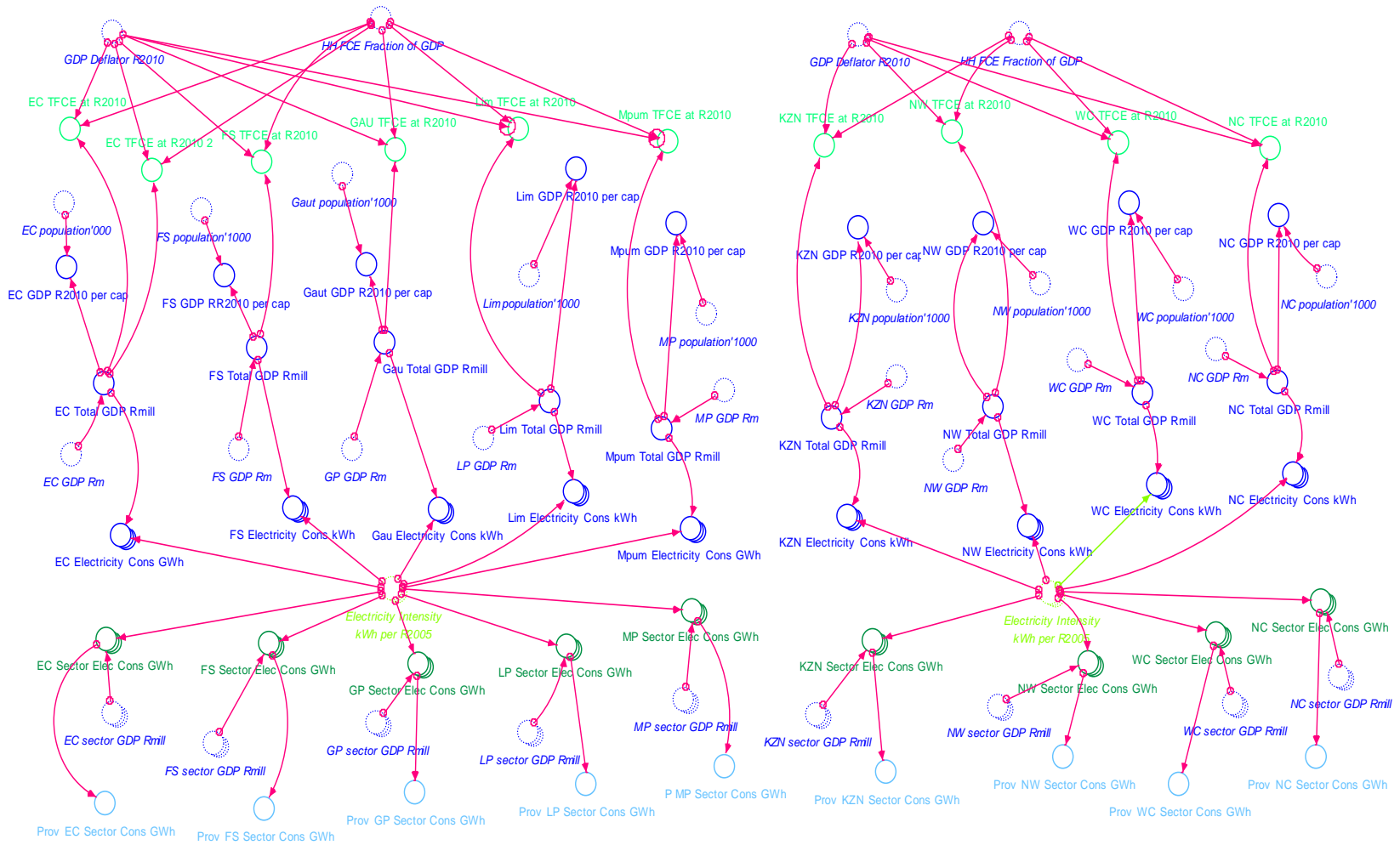
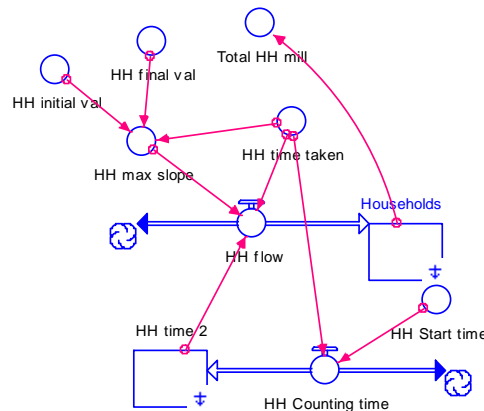

Figure 5.12: Provincial Sectoral Electricity Consumption

### 5.3.3 Income Module

#### 5.3.3.1 Household Sub-module

It was necessary to construct a model for the household growth nationally and on a provincial level so that this information could be linked to the number of ICEVs per household. Figure 5.13 shows the structure used to calculate the average household growth for South Africa.



**Figure 5.13: National Household Growth (1993-2050)**

The total number of households from 2017 until 2050 in Figure 5.13 was calculated using an annual growth rate of 3.17% based on the national household growth recorded in the April 2016 demographic values sourced from 2016 Stats SA General Household Survey (Stats SA, 2017), and an initial stock value of 8.35 million households in 1993.

The reason for not using the population stock and dividing it by the average number of people over time, is that household survey data from 1996 to 2006 indicate that the average size of the South African households has declined from 4.4 persons to 3.2 (Van Zyl, Cross, & O' Donovan, 2008) and if this trend is extrapolated past 2030, it means that the household numbers will become negative, which does not seem plausible with an increasing population and general socio-dynamics within societies.

The historic household data per province was obtained from DWA (2017) and Stats SA (2015) as well as the Bureau of Market Research (2007) and the fractions at 2016 (Table 5.3) were used to calculate the provincial distributions of households from 2017 until 2050 (Stats SA, 2017).

**Table 5.3: Provincial Share of Households (2016)**

Province	Provincial Households as a percent of National Households (%)
Eastern Cape	10.56
Free State	5.58
Gauteng	29.34
KwaZulu Natal	16.99
Limpopo	9.5
Mpumalanga	7.54
North West	7.54
Northern Cape	1.97
Western Cape	11

Source: Eighty20, Xtract based on AMPS 2014 data (StatsSA, 2015)

### 5.3.3.2 Real Disposable Income Sub-module

Studies by Medlock & Soligo (2002) indicate that although there is a positive relationship between economic growth in a country and the demand for private motor vehicles, the saturation levels vary across countries and user costs are a significant influence. Vehicle ownership volumes are different based on income distribution and consumers spending decisions (Lescaroux, 2010).

It was necessary to calculate the real disposable income on a national level first. The real disposable income from 1995 until 2015, at a 2010 base year, (Manamela, Mabaso, & Ligudu, 2017) was used to determine the trend from 2018 until 2050 using the regression Equation 5.7, where  $x$  is time.

$$\text{Real Disposable Income} = -27.165 \times x^3 + 1,732 \times x^2 - 4,824 \times x + 888,155 \quad \text{Equation 5.7}$$

The real disposable income per province from 2016 until 2050 was calculated using the fractions of average disposable income per household per province for 2014/2015 multiplied by the national disposable household income shown in Table 5.4 (Ruch, 2017).



**Table 5.4: Average Household Income per Province (2014/2015)**

Province	Average Disposable Household Income (R)	Fraction of National Average Disposable Household Income
Eastern Cape	90,156	0.0832
Free State	98,529	0.0909
Gauteng	193,771	0.1787
KwaZulu Natal	101,088	0.0932
Limpopo	79,152	0.0730
Mpumalanga	107,561	0.0992
North West	86,926	0.0802
Northern Cape	103,912	0.0959
Western Cape	222,959	0.2057

Source: Ruch (2017)

### 5.3.4 ICEV Module

Sub-modules were developed to link the real disposable income to the ICEV sub-module (which provided an indication of the number of ICEVs which would be afforded per income bracket per household)

#### 5.3.4.1 Actual ICEVs Sub-module

The first sub-module required calculating the provincial ICEVs based on actual historical time series data – this would then reflect “*Actual*” ICEVs. The empirical number of *Actual* registered motor vehicles per year was obtained from the Arrive Alive database (2017) and the National Automobile Association of South Africa (NAAMSA, 2017) from 1999 until 2016, shown in Figure 5.17, to model the growth per province using the regressions equations in Table 5.5 (from 2017 until 2050).

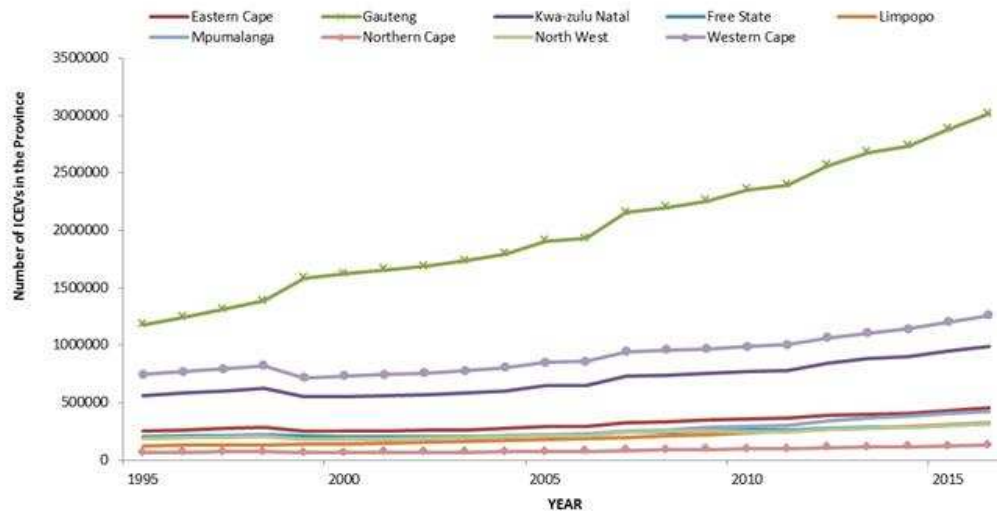

**Figure 5.17: Historical ICEV Data per Province**

Source: Arrive Alive (2017), NAAMSA (2017)

**Table 5.5: Regression Equations for Provincial ICEVs (where  $x$  is time)**

Province	Logistics Curve Equation	$R^2$
Gauteng	$y = 717.15x^2 + 62604x + 999073$	0.99
KwaZulu Natal	$y = 906.33x^2 - 4813.1x + 560580$	0.96
Western Cape	$y = 1031.8x^2 - 4971x + 740461$	0.97
Eastern Cape	$y = 411.73x^2 - 1948x + 252084$	0.96
Mpumalanga	$y = 264.9x^2 - 2080.1x + 207427$	0.96
Free State	$y = 587.45x^2 - 5091.1x + 195086$	0.98
North West	$y = 526.94x^2 - 4784x + 127315$	0.98
Northern Cape	$y = 154.81x^2 - 1314.8x + 68135$	0.97
Limpopo Province	$y = 243.57x^2 - 652.98x + 181270$	0.94

#### 5.3.4.2 Actual ICEVs with Scrappage Sub-module

An increase in personal disposable income was found to impact the consumer decision whether to buy a new passenger vehicle or keep the existing vehicle for a longer period i.e. a positive movement in exogenous factors results in an increase in replacement demand (Zide, 2012). Based on time series data, in the United States, vehicle scrappage rates in

year 2000 were 6% and this fell to 5.1% in 2008 (R.L Polk & Co., 2009), however, expectations for scrappage rates for 2019 are estimated at 6.9% per year (Statista, 2018).

Other studies estimate a scrappage rate of 0.84% per year (Demiroğlu & Yüncüler, 2016). Scrappage rates for passenger vehicles of varying vehicle age was composed based on data from 1987 to 2014, and included in a study by Bento et al. (2016), refer to Table 5.6.

**Table 5.6: Percent Scrappage Rate by Age for Passenger Vehicles**

Vehicle Age	2	3	4	5	6	7	8	9	10	11	12	13	14
Scrappage Rate (%)	1.5	1.84	2.03	2.56	3.79	5.3	7.17	9.4	11.75	<b>13.84</b>	15.65	17.18	18.29

Source: Bento et al. (2016)

A report generated by the Department of Transport indicated the average age of motor vehicles per province, shown in Table 5.7 (DOT, 2004).

**Table 5.7: Average Age of Motor Cars per Province**

Province	Average Age of Motor Vehicles per Province (Years)
Eastern Cape	10
Free State	12
Gauteng	9
KwaZulu Natal	10
Limpopo	11
Mpumalanga	11
North West	11
Northern Cape	12
Western Cape	10

Source: DOT (2004)

Based on the national average vehicle age of ~11 years, a scrappage rate of 13.84% (using the empirical guideline from Table 5.6) was built into the simulator. Figure 5.18 shows the model structure for the annual registered ICEVs with targeted scrappage rates, using S-curves for projections from 2017 until 2050.

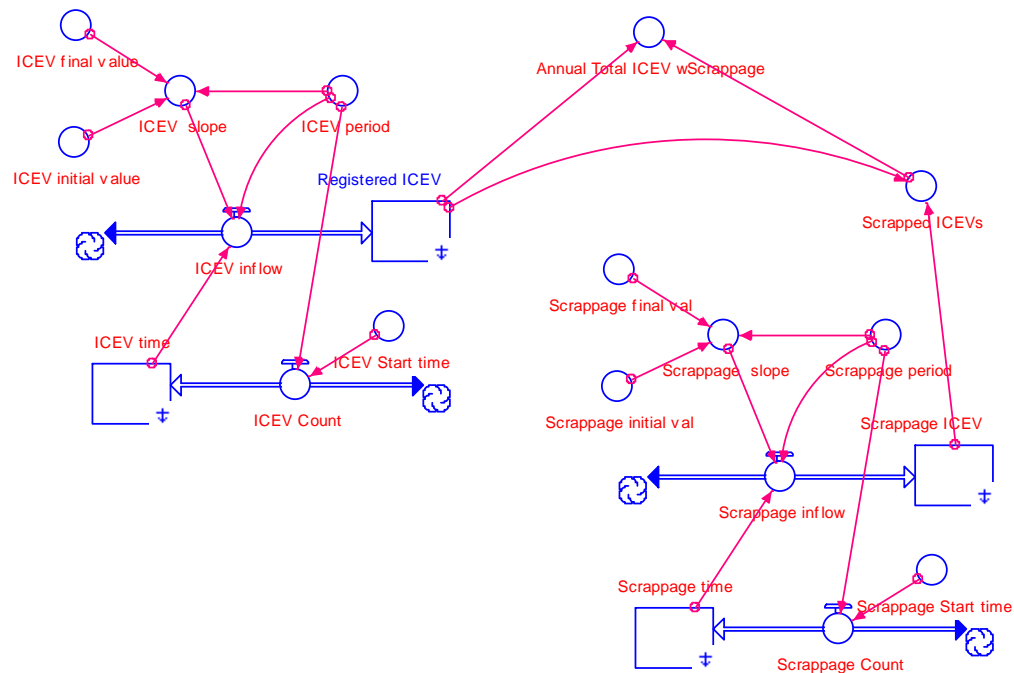

**Figure 5.18: ICEV Structure with Scrappage**

The reason for fitting an S-curve to the national actual registrations from 1993 until 2016 and then determining the trend from 2018 until 2050 was due to sources quoting new vehicle sales until 2050 (Merven, Stone, Hughes, & Cohen, 2012; Posada, 2018) and not the total registered number of ICEVs (which is what would be required to reflect the cumulative carbon emissions released in the transport sector).

The average distance travelled by passenger vehicles in 2009 was split into the provincial distributions shown in Figure 5.19, with an annual average of 15,867 km (Tongwane, 2013). Studies using the Vehicle Parc model by Mervin et al. (2012), indicate an average annual distance of 16,630 km for passenger vehicles, however, this value is calibrated to a new value of 24,000 km based on a 4.9% rate of mileage decay, new vehicle mileages and vehicle age. In a study by Deloitte, 80% of the surveyed drivers (over 13 000 consumers in 17 countries) indicated that they drove less than 80 km per day (Giffi, Vitale, Drew, Kuboshima, & Sase, 2011).

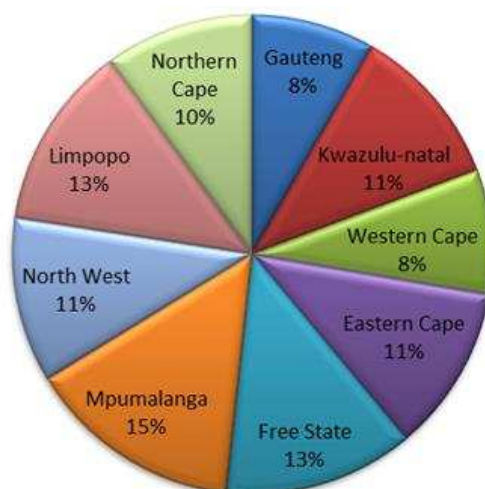

**Figure 5.19: Split of Provincial Annual Passenger Vehicle Distance travelled (2009)**

Source: Tongwane (2013)

The empirical data from the Eskom-Nissan BEV study indicated a value of 25,915 km per year (based on the daily average of 71 km), which was used for both the BEV and ICEV calculations in this study.

#### *5.3.4.3 ICEV Carbon Emissions and Fuel Efficiency Sub-module*

Due to vehicle technology improvements, as well as regulation reducing the vehicle mass and engine capacity, the fuel economy of ICEVs has improved over time. The Paris Agreement emission targets tie in with an expected 5.2% annual improvement in fuel efficiency from 2015 until 2021. An annual fuel efficiency improvement of 1% per year for new ICEVs from year 2018 was estimated, based on the Vehicle Parc Model developed by the Energy Research Centre (Merven, Stone, Hughes, & Cohen, 2012) and assumptions from a British study (Kwon, 2006).

This study used a 1% annual fuel efficiency improvement up until 2050, and built a sliding scale fuel efficiency improvement trend using S-curves from 1993 until 2050 (Figure 5.20) into the model structure.

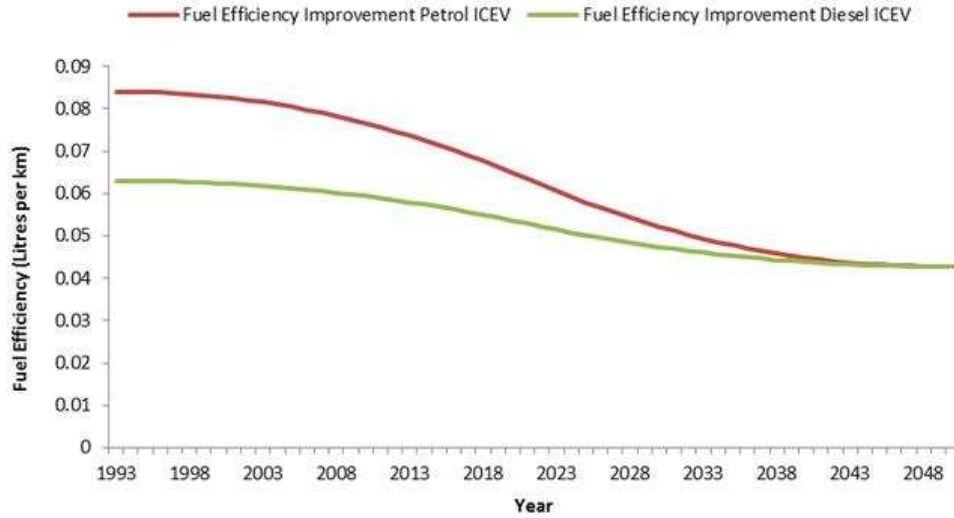

**Figure 5.20: S-curve of ICEV Fuel Efficiency Improvements (1993-2050)**

Vehicle population statistics in South Africa, indicates that 80% of vehicles are petrol and 20% are diesel fueled (SAMI, 2015; ArriveAlive, 2006). The fractions for diesel and petrol ICEVs were therefore set at 0.2 and 0.8 respectively. The fuel economy values and emission factors for the passenger vehicles were set at the values shown in Table 5.8 (Bischof-Niemz, et al., 2017).

**Table 5.8: Passenger Fuel Economy and Emission Factors**

	Fuel Economy (litres per km)	Emission Factor CO <sub>2</sub> (kg per litre)
Petrol ICEV	0.084	2.27
Diesel ICEV	0.063	2.68

Source: Bischof-Niemz, et al. (2017)

Figure 5.21 is the sub-module developed to account for the fuel economy improvements for the petrol and diesel ICEVs. The S-curves in Figure 5.20 were multiplied by the annual registered number of ICEVs (which includes the scrappage curve) and the annual distance. This was further multiplied by the relevant fuel fraction and then the respective emissions factors to calculate the annual ICEV CO<sub>2</sub> emissions.

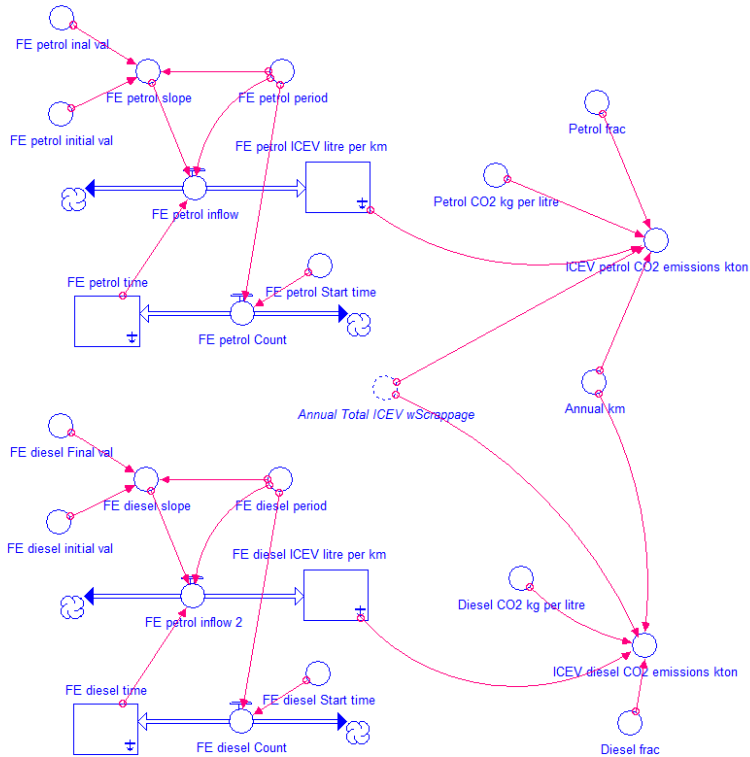

**Figure 5.21: Fuel Economy and ICEV Carbon Emissions Calculations**

The ICEV carbon emissions per province were then calculated by multiplying the provincial ICEV fractions at 2016 with the national ICEV carbon emissions time series converter. When BEVs were introduced and substituted with the ICEVs, carbon emissions calculations were updated to reflect the new carbon emissions in the transport sector.

#### 5.3.4.4 Affordable ICEVs Sub-module

Table 5.9 shows the average monthly income per proportion of households with a motor vehicle (Van Heerden, 2016) which was based on constructing conditional statements to check the income per decile per province then calculated the *Affordable* ICEVs, with the sub-module structure shown in Figure 5.22.

**Table 5.9: Monthly Income and Proportion of Households with ICEVs**

<i>Monthly Income Category</i>	<i>Proportion of Households with a Motor Vehicle</i>
Up to R799	2.8%
R800-R1 399	4.5%
R1 400-R2 499	2.9%
R2 500-R4 999	9.3%
R5 000-R7 999	20.7%
R8 000-R10 999	44.7%
R11 000-R19 999	75.2%
R20 000	145.3%

Source: Van Heerden (2016); IRR, Eighty20, XtracT based on AMPS (2014)

Figure 5.22 includes a per income decile calculation of ICEVs per province. The number of Actual and Affordable motor vehicles per income decile (nationally) was also calculated using the transport vehicle purchase expenditure fractions in Table 5.10 (Ruch, 2017).

**Table 5.10: Expenditure on Transport and Vehicle Purchases per decile**

<b>DECILE</b>	<b>1</b>	<b>2</b>	<b>3</b>	<b>4</b>	<b>5</b>	<b>6</b>	<b>7</b>	<b>8</b>	<b>9</b>	<b>10</b>
% Transport	11.8	10.7	10.7	11.3	11.1	12	12.9	13.8	15.1	19.6
% Vehicle Purchase	0	0	0	0.1	0.1	0.3	0.9	1.8	3.7	12

Source: Ruch (2017)



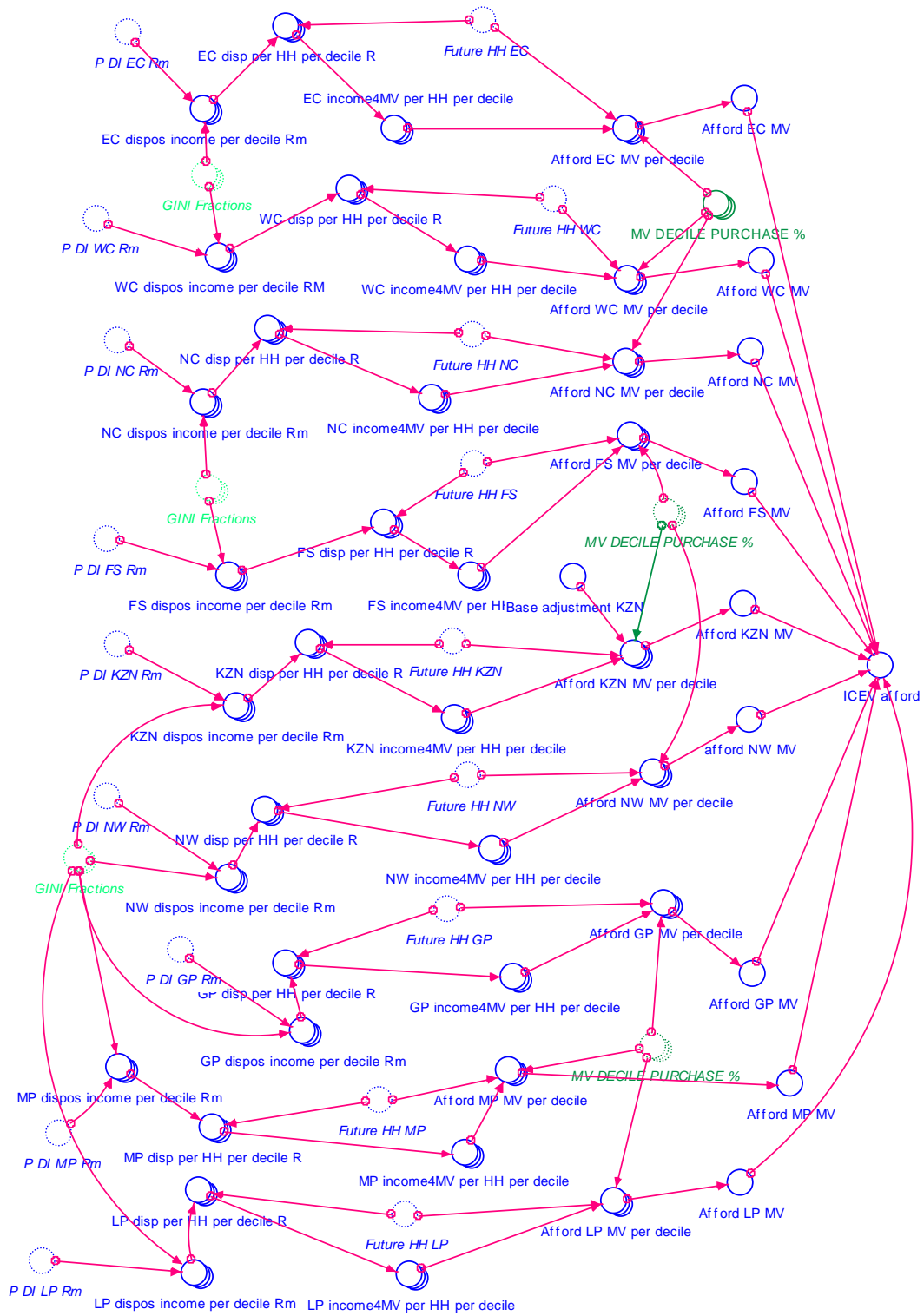

**Figure 5.22: Model Structure to Calculate Affordable ICEVs**

#### 5.3.4.4 ICEV Correction Factor

There are many influences which affect a consumer's choice to purchase a vehicle irrespective of their real disposable income and whether they can afford it. One such influence may be "New consumerism" which is a term to explain upscale spending of consumers driven by consumer aspirations, media influences, keeping up with community lifestyles etc. (Schor, 2011). Another reason for this variance is the fact that there are so many readily available vehicle finance schemes (with high balloon payments and interest rates) which encourage consumers to live on credit.

The relative weighting of these influences has not been quantified and covered in the scope of this study or uncovered through the detailed literature study however, this study has attempted to account for the "umbrella" of influences resulting in the gap, through a correction factor per province, shown in Figure 5.23. The ICEV Correction Factor is the ratio of the Actual ICEVs to the Affordable ICEVs. The national average ICEV Correction Factor was 1.77.

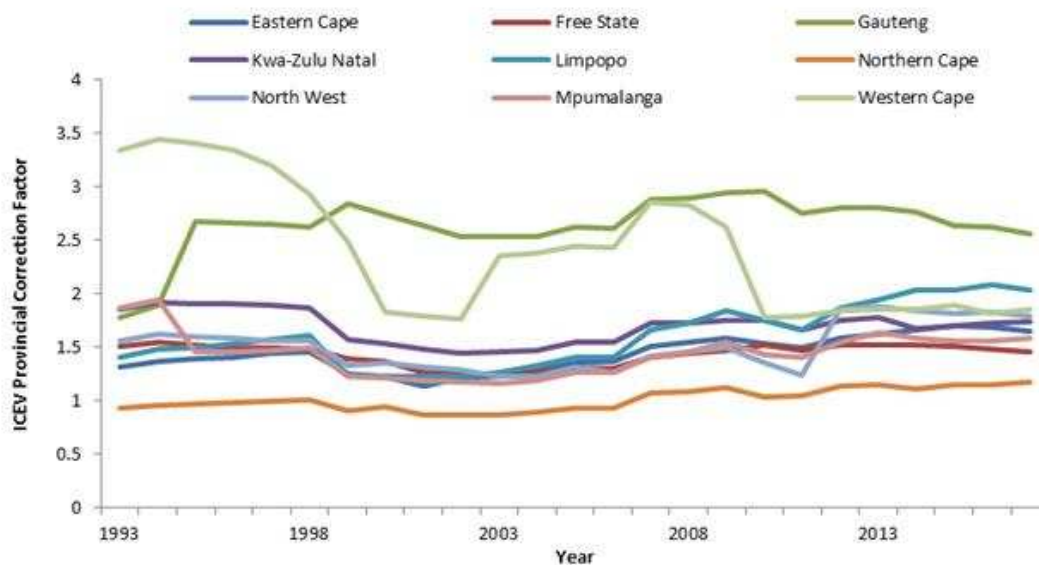
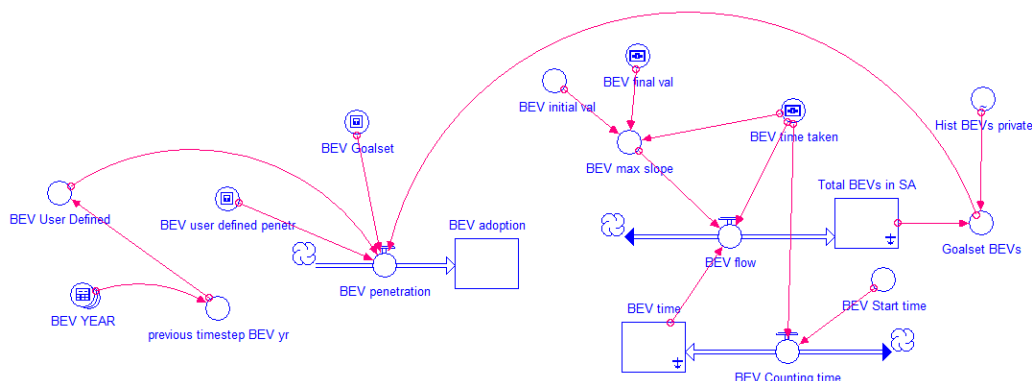

Figure 5.23: ICEV Correction factors for Provinces

#### 5.3.5 BEVs Module

For the E-StratBEV scenarios, a sub-module (Figure 5.24) was developed for setting BEV targets. A user was provided with two options. One way was to input a BEV goal-seeking target over a defined time period, the other option was to allow an annual input. Once these

targets were set, substitution with ICEVs was made structurally on a national level and per province.



**Figure 5.24: BEV Target Inputs**

### 5.3.5.1 BEV Provincial Distributions

Various parameter fractions (provincial differences in disposable income, GDP and ICEVs) were built into the structure to allow BEV distributions for the nine provinces, based on the chosen parameter fraction, shown in Table 5.11, provincial rankings depending on the parametric, in descending order with 1 being the highest and 9 being the lowest (based on 2016 provincial share data) (Stats SA, 2017; Stats SA, 2016; ArriveAlive, 2017).

**Table 5.11: Provincial Rankings for GDP, ICEVs and Disposable Income (2016)**

Rank	GDP (% share)	Population (% share)	ICEV Distribution (% share)	Disposable Income (% share)
1	Gauteng (34.72)	Gauteng (29.75)	Gauteng (41.77)	Western Cape (20.57)
2	KwaZulu Natal (15.93)	KwaZulu Natal (24.55)	Western Cape (17.37)	Gauteng (17.87)
3	Western Cape (13.79)	Eastern Cape (15.51)	KwaZulu Natal (13.72)	Mpumalanga (9.92)
4	Eastern Cape (7.54)	Western Cape (13.93)	Eastern Cape (6.27)	Northern Cape (9.59)
5	Mpumalanga (7.24)	Limpopo (12.86)	Mpumalanga (5.84)	KwaZulu Natal (9.32)
6	Limpopo (7.22)	Mpumalanga (9.62)	Limpopo (4.50)	Free State (9.09)
7	North West (6.14)	North West (8.31)	North West (4.39)	Eastern Cape (8.32)
8	Free State (5.23)	Free State (6.27)	Free State (4.38)	North West (8.02)
9	Northern Cape (2.20)	Northern Cape (2.64)	Northern Cape (1.78)	Limpopo (7.30)

Source: Stats SA (2017); Stats SA (2016) and ArriveAlive (2017)

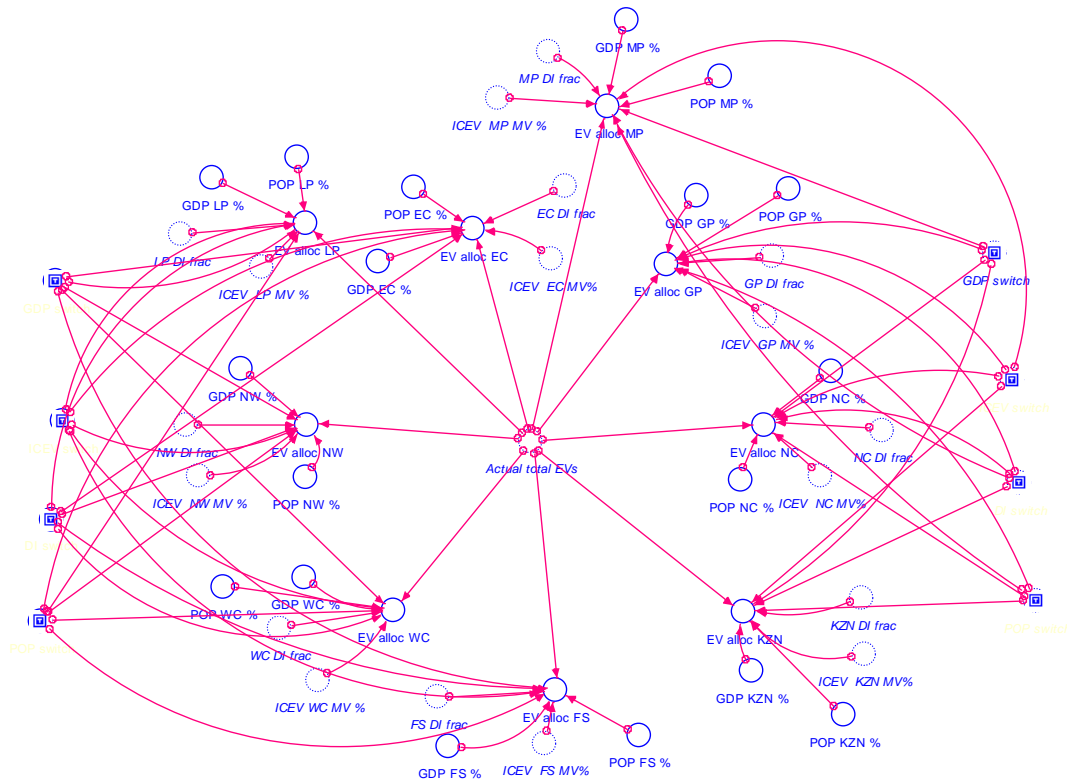

**Figure 5.25: Provincial Distribution of BEVs**

### 5.3.5.2 BEV Adjustment Factor

Similar to the difference between Actual and Affordable ICEVs, it is expected that the actual BEV penetration may be higher than what is expected, with various interventions and drivers. To account for this secondary impact of additional BEVs to the BEV penetration target, the BEV target was multiplied by the ICEV Correction Factor fraction (0.0177) to calculate the additional number of driver related BEVs ( $BEV_{drivers}$ ) (Equation 5.8).

$$BEV_{drivers} = \left[ \left( \frac{ICEV_{act}}{ICEV_{afford}} \right)^{-1} \right] \times BEV_0 \quad \text{Equation 5.8}$$

### 5.3.5.3 BEV Drivers

Literature indicates that there are several BEV drivers, however, based on the feedback from drivers of the BEVs during the Eskom EV pilot study (Langley, 2016), the BEV drivers in Table 5.12 were chosen, with relative weighted values, to represent the additional BEVs which may be expected in addition to BEV targets set. The stock level of the  $BEV_{drivers}$  variable would thus be affected to varying degrees by the purchase price, range anxiety, charging station infrastructure and the reputation of the electric vehicles. The weight

fractions in Table 5.12 were based on expert opinion and engagement with subject matter experts involved in the Eskom eMobility program.

**Table 5.12: Weight Fractions of Factors affecting BEV Penetration**

Variable	Weight Fraction
Purchase Price	0.5218
Range Anxiety	0.310
Charging Station Infrastructure	0.168
Reputation of Electric Vehicles	0.001

From the surveys conducted in the pilot study (Langley, 2016), it was noted that range anxiety experienced by the drivers would have decreased if the range of the BEV was higher (possibly by improved battery technology allowing for higher driving ranges in the future) (Parker, 2017). “Range anxiety” (driver worrying that battery of the electric vehicle will run out of power before they arrive at their destination), was also factored into the influences on BEV market penetration. Regression analysis of the forecasted battery technology improvement expectations with range anxiety resulted in Equation 5.9.

$$\text{Range Anxiety}(y) = -0.001(x^2) + 0.1886(x) + 85.035 \quad \text{Equation 5.9}$$

The following sub-module (Figure 5.26) was built to link the range anxiety to battery technology improvements, after which a time series ratio of range anxiety to battery range was calculated and multiplied by  $BEV_{drivers}$  to determine the contribution to additional BEVs over time.

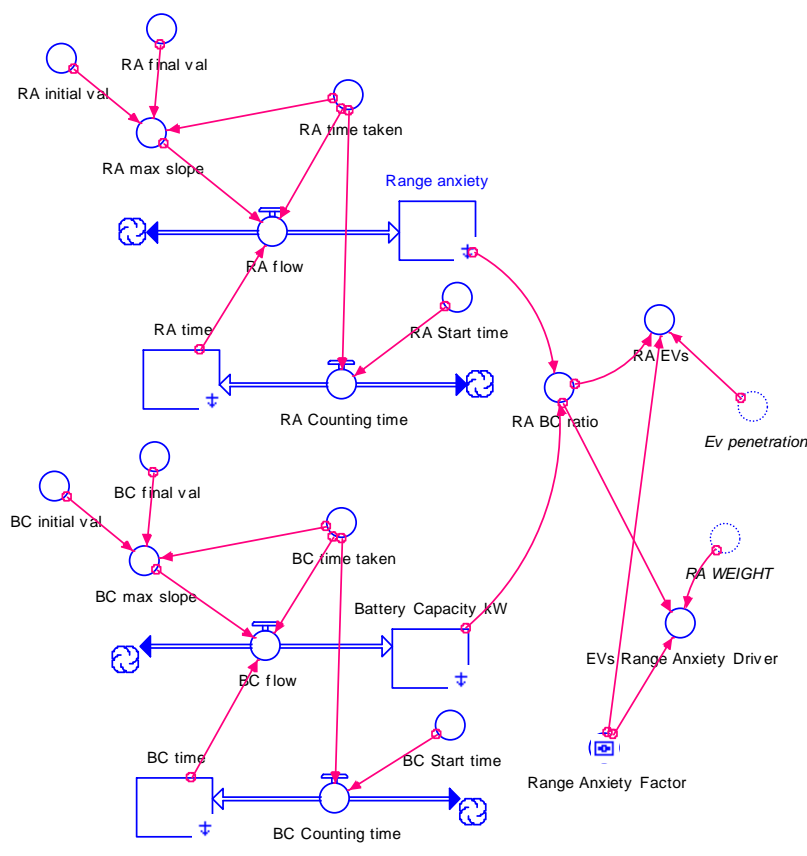

**Figure 5.26: Range Anxiety Impact on BEV Penetration**

The reputation effect driver was calculated next, shown in Figure 5.27, with the reputation improving over time with a related increase in BEVs. Similarly, to Figure 5.27, a structure linking the scaled impact of charging infrastructure was built.

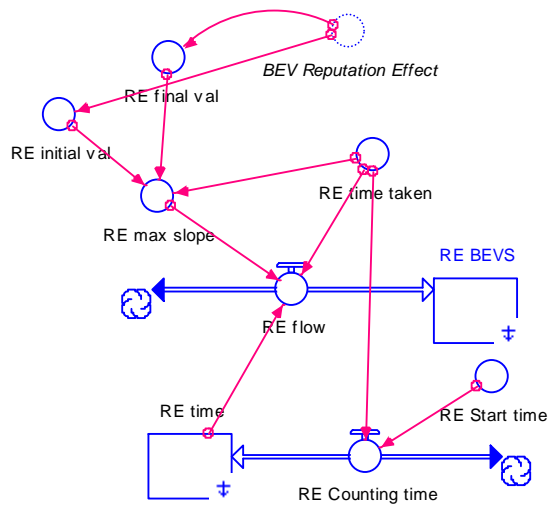

**Figure 5.27: Reputation Effect Impact on BEV Penetration**

Before the structure for the purchase price impact on BEV penetration could be developed, information and data from various sources (Green Car Reports, 2016; Parker, 2017; Coffman, Bernstein, & Wee, 2015; IEA, Global EV Outlook, 2013) was obtained and plotted on a graph (Figure 5.28), after which a regression equation was established to fill in those battery cost values which were not cited in literature.

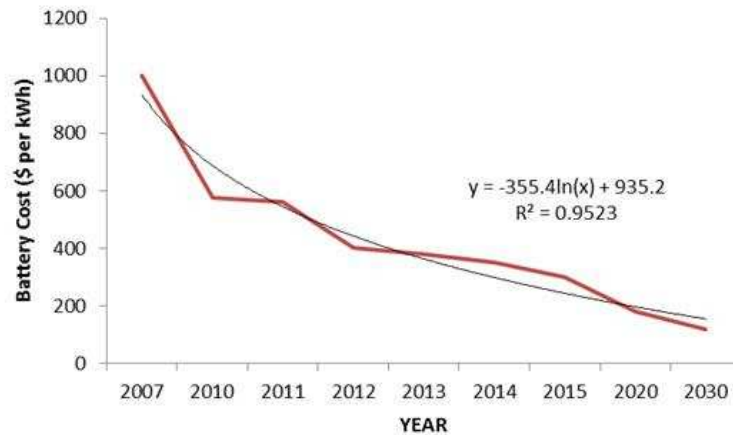

**Figure 5.28: Lithium-ion Battery Cost over Time**

The regression equation was built into the model structure linking production cost, import taxes, VAT and battery costs to the overall impact of purchase price decreases on BEV penetration. This trend would have to be calibrated over time as more empirical data for South Africa is obtained through various BEV projects. Figure 5.29 shows the input graph used to link the Purchase Price to the rate of penetration.

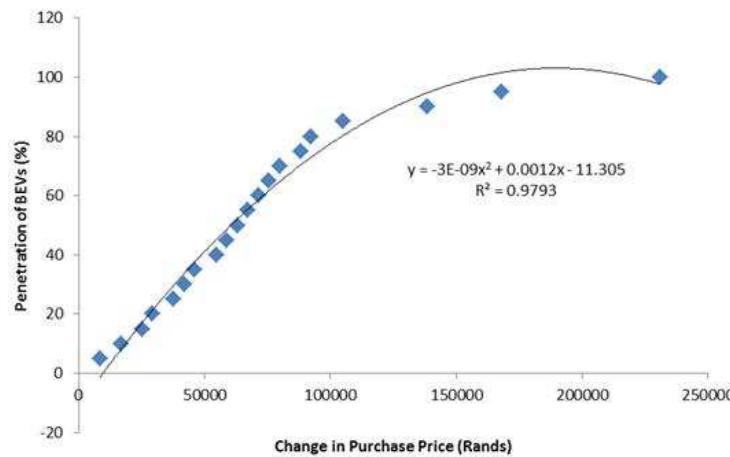

**Figure 5.29: Penetration of BEVs Influenced by Purchase Price**

The purchase price is affected by the production cost (largely changes in the battery cost), import taxes, and VAT. The structure for the purchase price is shown in Figure 5.30 and used an initial import tax of 42% and a VAT of 14%.

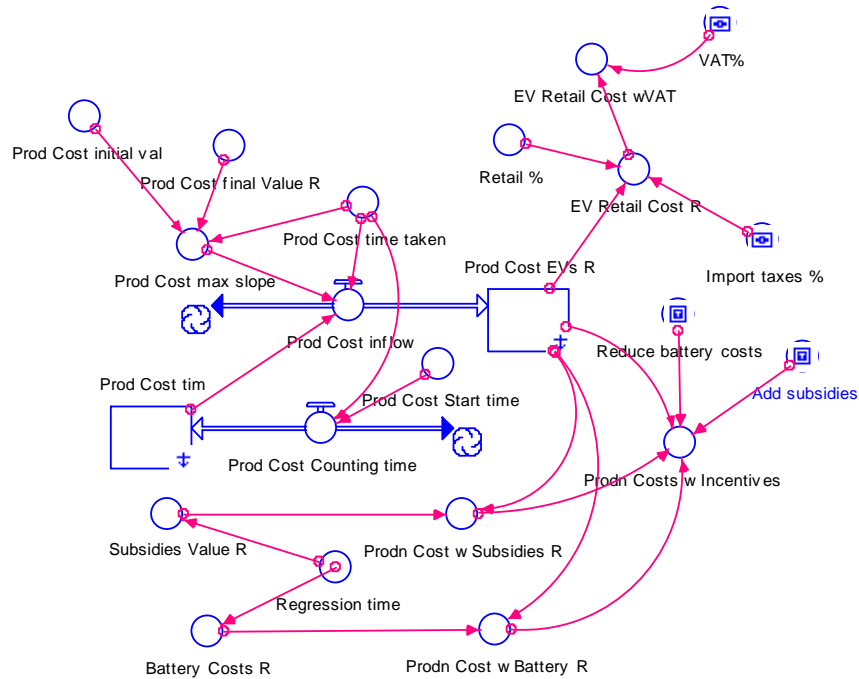

**Figure 5.30: Purchase Price Impact on BEV Penetration**

The impact of charging station infrastructure was modelled in the same way as the reputation effect and the purchase price. Thereafter, Figure 5.31 illustrates the calculation of the new number of BEVs after having taken the drivers into consideration.

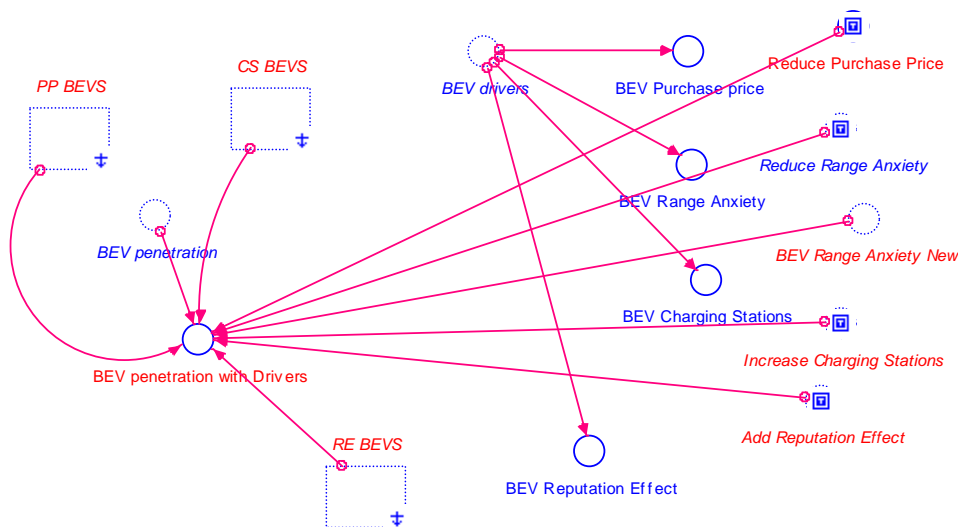

**Figure 5.31: Change in BEV to Charging Station Ratio Impact on BEV Penetration**



#### 5.3.5.4 BEV Charging Requirements

The BEV electricity charging demand was calculated using Equation 5.10, where Power Consumption equals 21.25 kWh per 100 km based on empirical data from the Eskom-Nissan pilot study (Langley, 2016).

$$BEV\ electricity\ demand = Distance \times Power\ Consumption_{BEV} \times No\ of\ BEVs_{province} \quad \text{Equation 5.10}$$

The electricity demand for charging the BEVs based on the targets and allocations were then added to each provincial electricity demand value to determine the impact on the energy and capacity reserve margins.

### 5.4 E-StratBEV validation

Model validation is carried out on a *structural* level (assessing if the model's influence structure is consistent with that of the real system) (Quadrat-Ullah, 2005), in terms of the model behaviour (determining if the model qualitatively produce the same results as the real system with respect to rates of change, oscillations, stability, etc.); *empirically* (checking if the model outputs correspond quantitatively (within the bounds of its purpose) with empirical results from the real system) (Sterman, 1984); and in terms of the *application* (determining if the modelled domain, complexity and functionality aligned with the purpose of the simulation) (Barlas, 1996). Validation of the structure and key variables in E-StratBEV was through frequent stakeholder engagement with Eskom's eMobility team to ensure that there was consistency in drivers and dynamics being considered based on experience by the team due to the Nissan-Eskom Nissan Leaf initiatives, and current work underway. Besides several engagements within the organisation, in terms of expert opinion validation, engagements were held with Hiten Parmar, the Director of the uYilo e-Mobility Programme, whereby the simulator was demonstrated and assumptions on variables such as percent charging at home, driver impact sensitivity, EV targets, and affordability was discussed and confirmed, based on his experience. Watson Collins from the Electric Power Research Institute was also engaged with on assumptions and the structure of the model as well as results.

Parameterization of time series data, in instances where there was insufficient empirical history or data consistency for the South African EV market, was through regression analysis. Historical and future trends in the supply and the demand modules were compared to historical operational planning trends completed by staff at Eskom.

## 5.5 E-StratBEV Engagement Platforms

Engagement platforms, using iSee Stella, were developed to allow various scenario runs. Figure 5.32 allows the supply sub-module to be run with a coal base heavy mix and then with a renewables heavy mix, observing the difference in energy and capacity reserve margins for BEV substitutions with ICEVs.

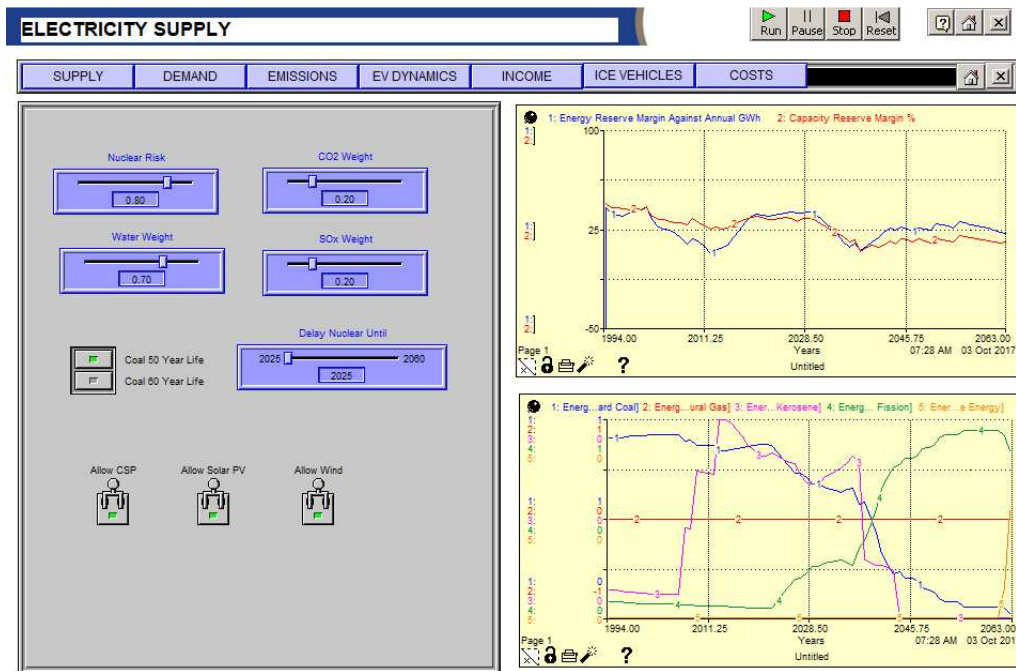

Figure 5.32: Supply Side Engagement Platform

Figure 5.33 allows the user to change factors such as GDP and the Gini coefficient, which are mathematically linked to the electricity demand in the various economic sectors and the residential sector. A GDP slider allows for a constant year on year annual increase value (default set at 2%). The final value for the GDP can also be changed to a goal driven target over a changeable period as well.

This interface allows the Gini coefficient to be changed from a minimum of 0.20 to a maximum of 1, and was set at a default of 0.68. The graph on the top right shows the change in the sum of the provincial residential consumption and the graph on the bottom right allows comparative runs of the economic sectors and overall national electricity consumption when the GDP and Gini coefficient are changed.

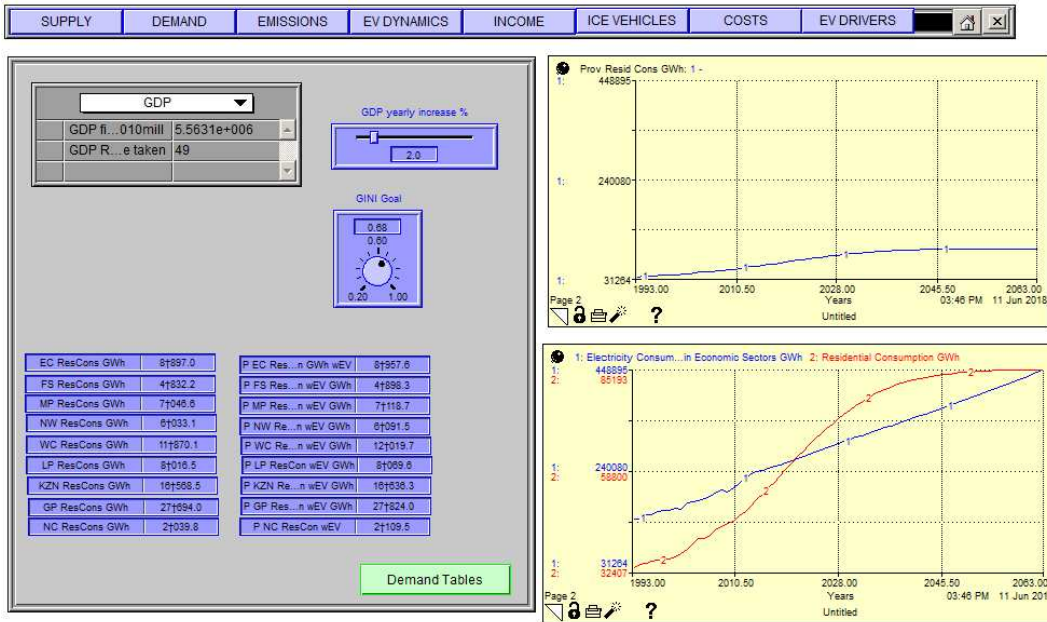

Figure 5.33: Gini coefficient and GDP Engagement Platform

The following Figure 5.34 shows the engagement platform to introduce a target number of BEVs for substitution with ICEVs.

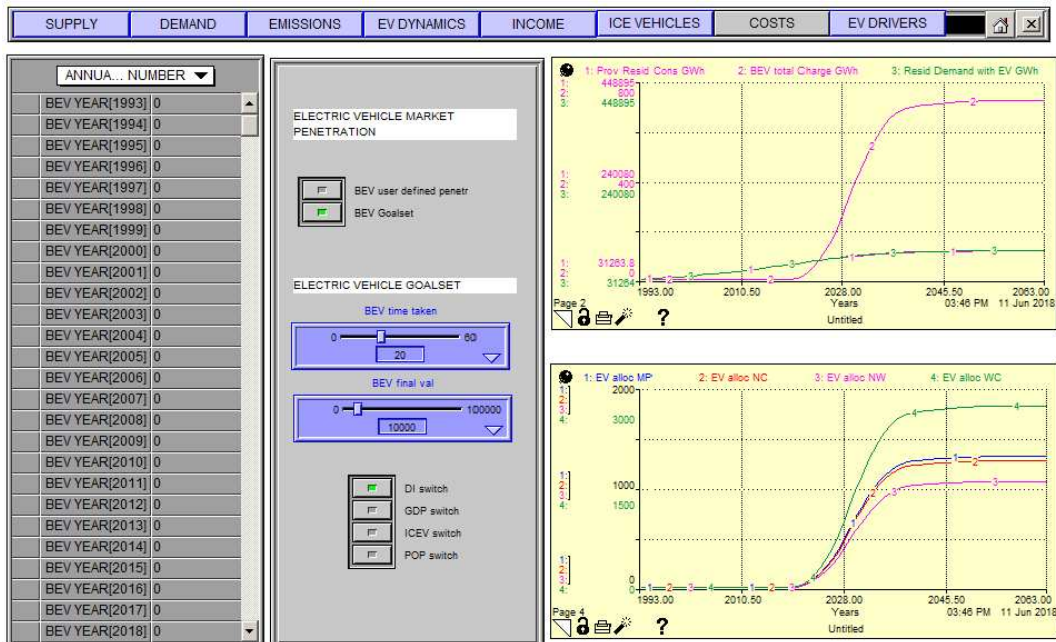
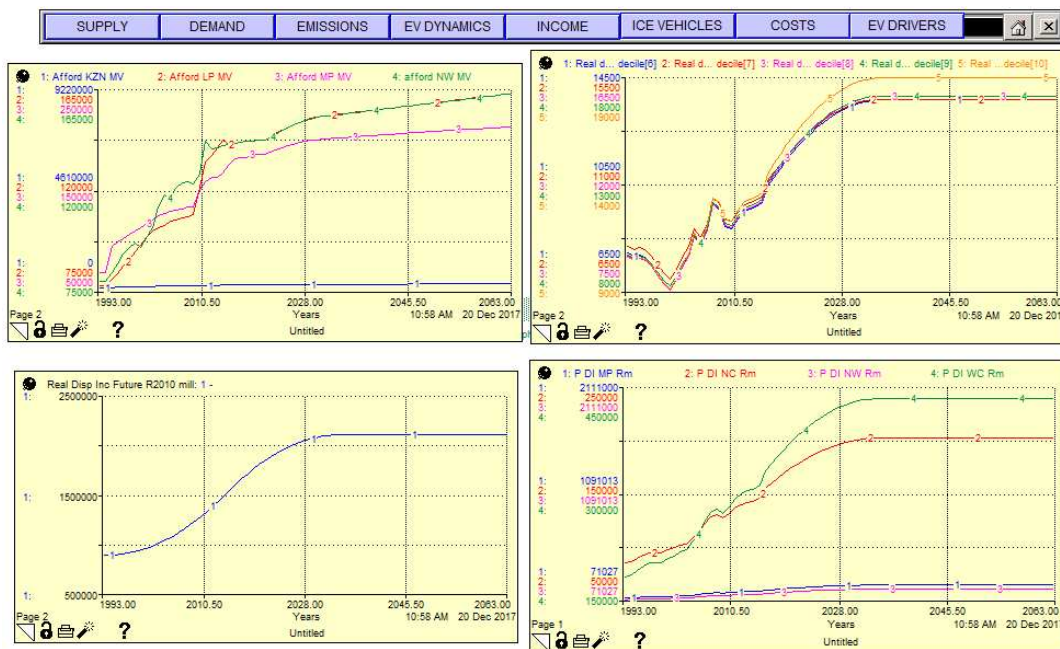

Figure 5.34: BEV Target Setting

The table on the left side of Figure 5.34 allows an annual entry of BEVs from year 2015 until year 2050. This interface also allows a goalsetting target BEV over a certain period of years.

Push buttons allow a choice of the manual table entry for BEVs or a goal-setting target. Parameter choices for disposable income or GDP or ICEV or population is also provided and based on the option chosen, various allocations of BEVs are made into the provinces. The graph on the top right shows the residential consumption with and without BEVs, and the BEV electrical charging requirements. The bottom right graph shows the provincial allocations based on the parameter (disposable income or GDP or ICEV or population) chosen to make the allocation.

Figure 5.35 shows the disposable income nationally per decile (top right graph), per province (bottom right graph), the national total (bottom left graph), and the affordable ICEVs linked to disposable income (top left graph).



**Figure 5.35: Disposable Income Engagement Platform**

Figure 5.36 shows the ICEV results, actual per decile nationally (top left graph), actual and affordable ICEVs nationally (top right graph), affordable per decile nationally (bottom left graph) and actual per province (bottom right graph).

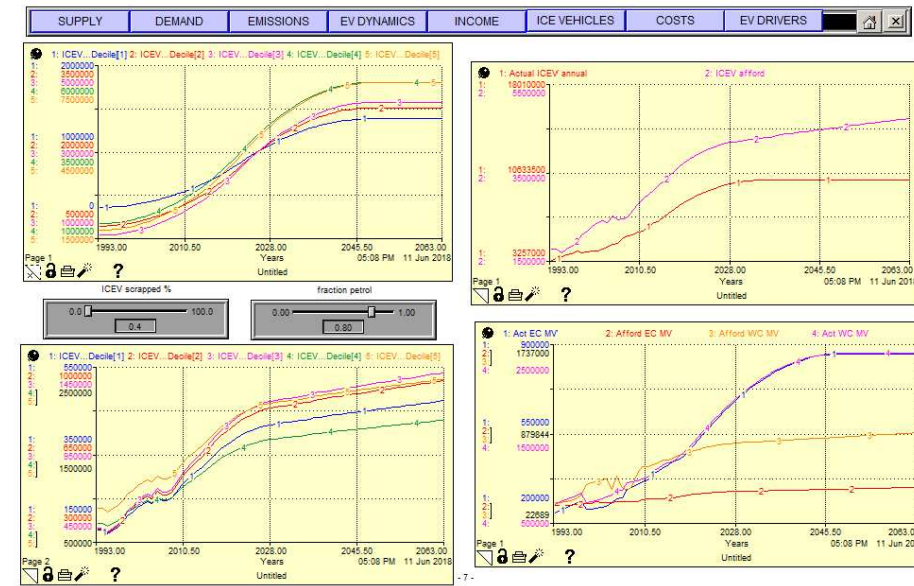

Figure 5.36: ICEV Engagement Platform

Figure 5.37 displays the results for the number of BEVs due to a specific driver (top left graph) while the bottom left scatter graph shows the relationship between range anxiety and battery capacity built into a feedback loop in the model.

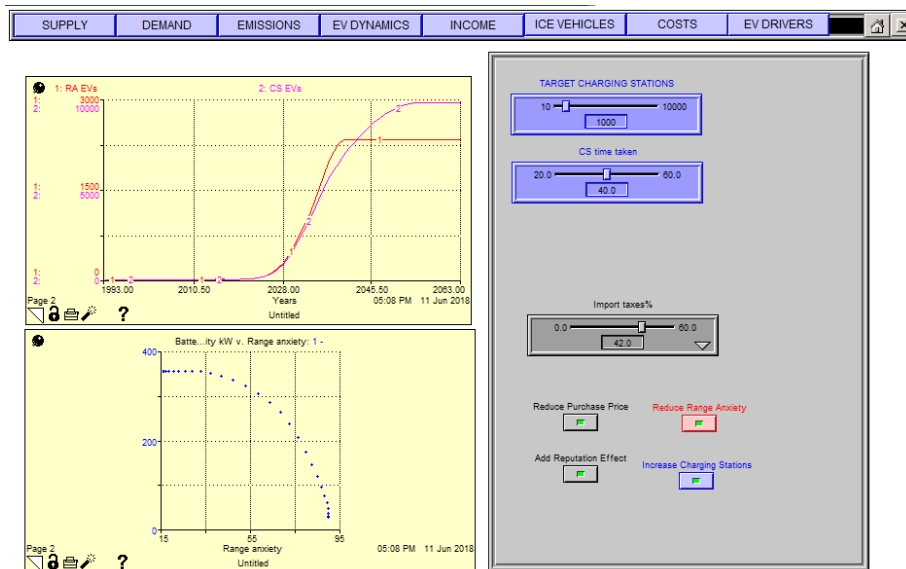

Figure 5.37: BEV Drivers Engagement Platform

A slider on the top right panel, allows a selection of charging stations and depending on the ration of



Figure 5.37 has sliders which allow the user to change the number of charging stations and the time taken to reach that goal. The ratio of BEVs to charging stations is also linked to additional BEVs; then added to the target driven number; besides the additional BEVs when the switches are activated for: range anxiety reduction; inclusion of reputation effect; and a change in the purchase price. The impact of reducing import taxes (currently set at 42%), and the overall impact on purchase price was also factored in.

## 5.6 Summary

A long-term strategic system dynamics model named E-StratBEV was developed using iSee STELLA. This chapter showed the various module structures of E-StratBEV, causal feedback loops, as well as the mathematically linked variables in a complex system looking at the impact of BEVs on electricity planning. E-StratBEV has the necessary elements to meet the research objective of developing a mathematically sound, system representative simulation tool using an adapted system dynamics modelling process to allow for scenario and sensitivity analyses.

The development of various interfaces with controls would allow for the necessary scenario runs and sensitivity analysis to address the following research objectives:

- Establishing the BEV targets and determine the provincial BEV distribution with the most suitable parameter,
- Calculating the current forecast for registered vehicle purchases and those expected based on disposable income and affordability,
- Determining the impacts of drivers such as purchase price, charging infrastructure, range anxiety and reputation effect on the BEV market penetration rates,
- Understanding the impact of BEVs on residential electricity consumption,
- Calculating the trade-off in environmental impacts of BEVs in the transport and energy sectors, and
- Establishing an adjusted provincial distribution of BEVs based on affordability and spending behaviour of consumers in the various deciles.

# Chapter 6: Results and Discussion

---

## 6.1 Overview

Using a system dynamics modelling process, a long-term Electricity Strategic Battery Electric Vehicle (E-StratBEV) model was developed to causally and mathematically link the variables in the scope of this study, allowing scenario analysis to address the research objectives to:

- Understand the provincial propensities for BEV adoption based on varying parameters (disposable income, GDP and ICEV fractions) so that the appropriate parameter for provincial distributions could be selected.
- Determine the current forecast for vehicle purchases and those expected based on disposable income and affordability.
- Examine the impacts of battery electric vehicle market penetration rates on residential electricity demand (including varying the electricity generation supply mix).
- Determine the impact of key drivers on BEV market penetration
- Calculate the environmental impact due to BEV penetration in the transport and energy sectors.
- Determine the adjusted number of BEVs based on expenditure linked to vehicle purchases within deciles and compare it to the expected number of BEVs per province.

## 6.2 BEV Scenario Definitions

The timeframe for the simulator was from 1993 until 2050 with an annual resolution, to coincide with the timelines for the Green Transport Strategy (DOT, 2016), and the Integrated Energy Plan (DOE, 2016).

The E-StratBEV uses a Low Growth and a High Growth BEV scenario.

A. *Low Growth scenario (LG)*: Transportation analysts at Bloomberg New Energy Finance forecast that global sales of electric vehicles will reach 41 million by 2040 (about 35% of new light duty vehicle sales) (Randall, 2016). An increase in luxury goods purchases (such as electric vehicles) appears to correlate positively with an improvement in economic conditions within a country (Reyneke, Sorokáčová, & Pitt, 2012), thus using the GDP parametric (South Africa's GDP is on average 0.0057 of the world GDP), means a target of 233,700 BEVs by 2040 for South Africa. If BEV sales were already

incentivised by the drivers included in this study, then the disposable income fractions could have been used.

- B. *High Growth scenario (HG)*: Based on South Africa's pledge to support the Paris Agreement on Climate Change commitments in April 2016, signed by the Minister of Environmental Affairs (DEA, 2016), South Africa should be targeting 2.9 million EVs by 2050. Using an S-curve to find the value at year 2040, this would equate to a target of 2.39 million EVs by 2040 (for the period starting at 2019).

Using goal-seeking S-curves in E-StratBEV, for the Low Growth and High Growth scenarios, Table 6.1 indicates the new annual BEV sales which would be required.

**Table 6.1: Annual BEV Sales Required for BEV Scenarios**

Year	Low Growth Annual BEV Sales	High Growth Annual BEV Sales
2019	1931	19752
2020	3862	39503
2021	5794	59255
2022	7725	79007
2023	9656	98758
2024	11587	118510
2025	13518	138262
2026	15449	158013
2027	17381	177765
2028	19312	197517
2029	21243	217268
2030	19312	197517
2031	17381	177765
2032	15449	158013
2033	13518	138262
2034	11587	118510
2035	9656	98758
2036	7725	79007
2037	5794	59255
2038	3862	39503
2039	1931	19752
<b>TOTAL</b>	<b>233,700</b>	<b>2,389,950</b>



## 6.3 The South African Economy

Before commencing with scenario runs to address the research objectives, an understanding of the economy in terms of GDP, income distribution, and disposable income was required.

### 6.3.1 GDP

Although GDP per capita is usually used as a measure of average living standards, a high GDP per capita does not always mean high levels of household income, especially since not all income generated by the economic activity in a country ends up in households (OECD Statistics Directorate, 2016). Thus, it is important to understand the economy of South Africa through the GDP since economic growth has also positively been linked to the purchase of luxury goods<sup>12</sup> (such as electric vehicles) (Kapferer, 2012), in addition to household disposable income.

Figure 6.1 illustrates the average GDP on a provincial level for period 1993 to 2018 and then from 2019 to 2050. The reason for dividing the data into two periods was to understand the historical relative average GDP growth between provinces and what the expected average GDP growth is likely to be.

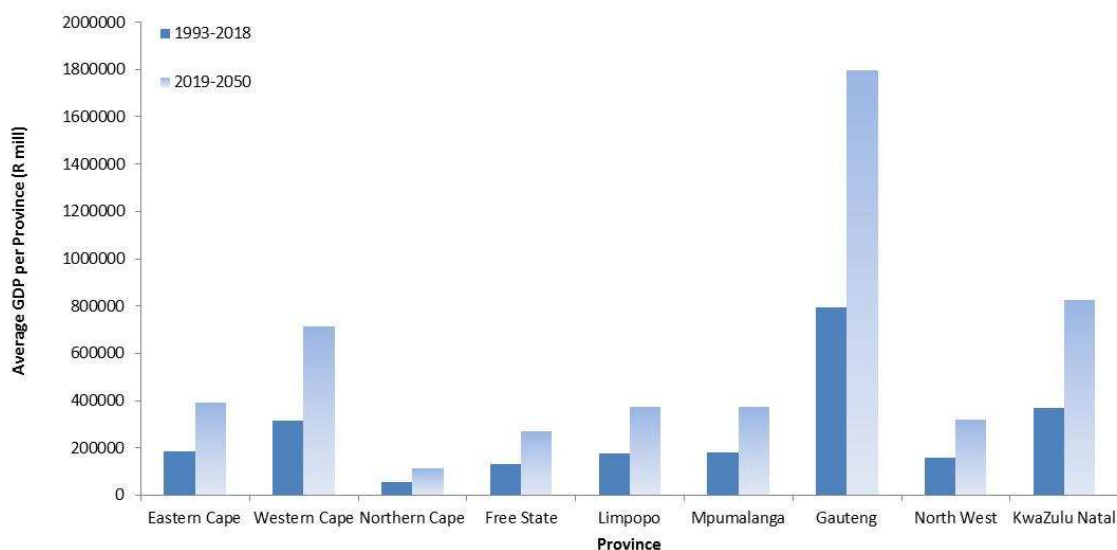

**Figure 6.1: Average GDP per Province per Period 1993-2018 and 2019-2050**

<sup>12</sup> A luxury good is a good for which demand rises increases more proportionally as income rises

Gauteng, KwaZulu Natal (KZN) and the Western Cape provinces are seen to have the highest relative provincial economic growth, with the lowest average growth in the Northern Cape, Free State and the North West provinces.

The primary sector is made up of agriculture and mining. The secondary sector includes manufacturing, construction and utilities. The tertiary sector includes finance, trade, government services, transport and personal services. On average, the primary sector contributes 12%, the secondary sector contributes approximately 31% and the rest is the contribution by the tertiary sector to the economic growth of South Africa on a national level (StatsSA, 2017). The historical GDP growth (1993-2018) on a provincial level has been driven by changing dynamics in the primary, secondary and tertiary industries. According to the South African Institute of Race Relations, Gauteng, KwaZulu Natal and the Western Cape account for 55.2% of the national population but contribute 64.1% to South Africa's GDP (IRR, 2017). The Real Economy Bulletin, published in 2016 (Makgetla & Fotoyi, 2016), indicates that Gauteng province accounts for over a third of the GDP, and almost a quarter of the population, in South Africa, whilst the Eastern Cape province population fraction is 13% with an 8% share of GDP, clearly illustrating the vast differences in the economies and GDP per capita on a regional scale in South Africa.

Gauteng province and the Western Cape province's economies driven by finance, real estate and the business services in the tertiary sector (South African MI, 2015) while the primary sector plays a pivotal role in Mpumalanga province, Limpopo province and North West province. The KwaZulu Natal province experiences economic growth largely through manufacturing with the highest fraction in transport and communication (due to Durban Harbour and the Richard Bay coal terminal contributions to transportation and good storage for export and import); while mining and quarrying drive the growth of the North West province, Limpopo province and Mpumalanga province. The tertiary industry was identified as having contributed about 65% of the Free State province's economy (Treasury, 2017).

Economic growth is expected to be positive over an average 30 year period from 2019 until 2050 for all the provinces, with South Africa aiming to increase the economy from R4.12 trillion in 2017 to R8.85 trillion by 2025 (Aiyer, 2018). For this to be realized, however, by 2025 the economic pie would have to comprise of 30% of GDP for the industrial sector, 60% of the services sector, 7.5% of the agricultural sector and the rest taken up by the other sectors (Aiyer, 2018). This would mean high economic growth in Gauteng and the Western Cape specifically.

### 6.3.2 GDP and Gini Coefficient Impact on Residential Consumption

Literature (Clarke, 1995; Bagchi & Svenjnar, 2015) indicates a negative relationship between economic growth and income inequality, but more importantly, it is necessary to understand the individual impact of these economic parameters on residential electricity consumption.

The simulator used the latest Gini coefficient (based on income per capita), which was 0.68 in 2015 and a GDP growth rate of 2% based on South Africa's National Treasury Budget Review (National Treasury, 2017), from 2018 until 2050 (the end of the simulator timeframe). South Africa's National Development Plan has included a target of 0.59 for the Gini coefficient and a doubling of the GDP (4%) by year 2030 (South African Government, 2015). An improvement in income distribution and economic growth in the country would result in an increase in electricity consumption, thus it is important to also understand the quantitative nature of this impact, through scenarios run in E-StratBEV. Based on a constant 2% GDP growth rate and two different Gini coefficients (0.68 & 0.59), scenarios were run without BEVs. Thereafter, the Gini coefficient was kept constant at 0.68 and scenarios were run using two different GDP values (2% & 4%), without BEVs. The cumulative impact on residential consumption from 1993 until 2050 is shown in Figure 6.2.

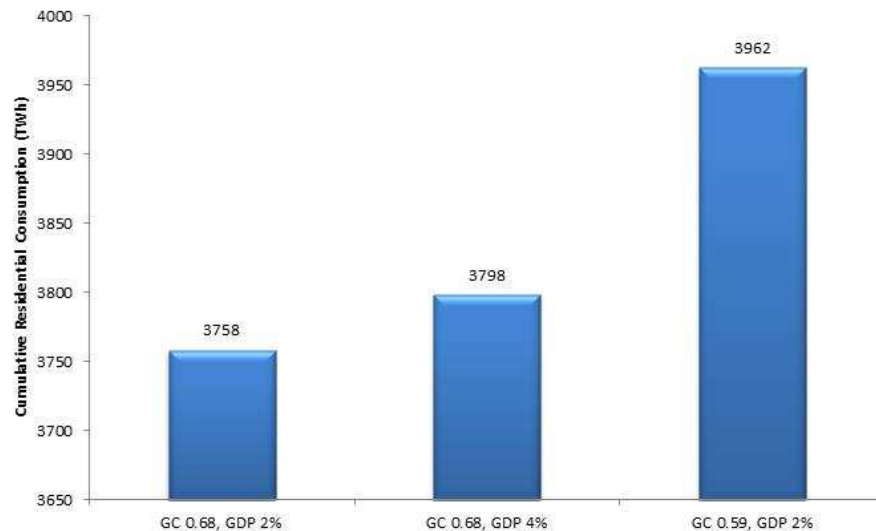

**Figure 6.2: Impact of GDP and Gini coefficient on Cumulative Residential Electricity Consumption (TWh)**

Doubling the GDP resulted in a 1.1% increase in residential consumption, while an improvement to attain the targeted Gini coefficient in the National Development Plan results in a 5.4% increase in residential consumption, significantly higher. With improved income distribution, the increased residential consumption could be due to the lower income deciles

having an increased capacity to purchase more electrical appliances such as fridges and televisions while the middle and higher income deciles tend to buy luxury goods such as air conditioners or multiple televisions (Pillay, 2014).

### 6.3.3 Disposable Income

The real disposable income per province was plotted to understand the relative trends on a provincial level (Figure 6.3). Luxury goods are identified as having a high income elasticity of demand i.e. as people get wealthier, their average household income increases accompanied by an increase in the demand for luxury goods (Caserta, 2008). The highest real disposable income is in the Western Cape province followed by Gauteng province.

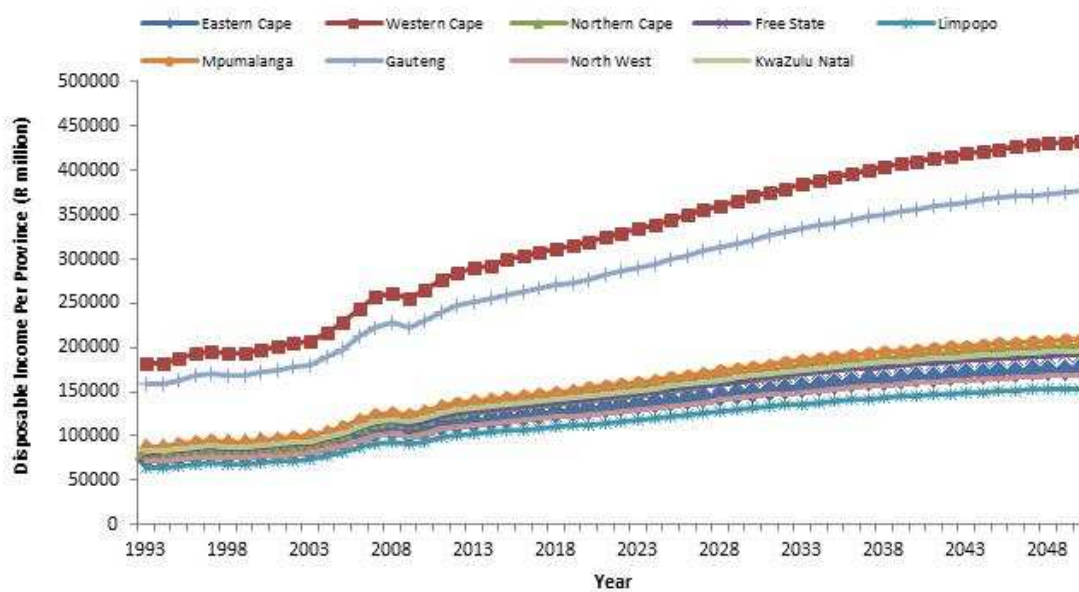
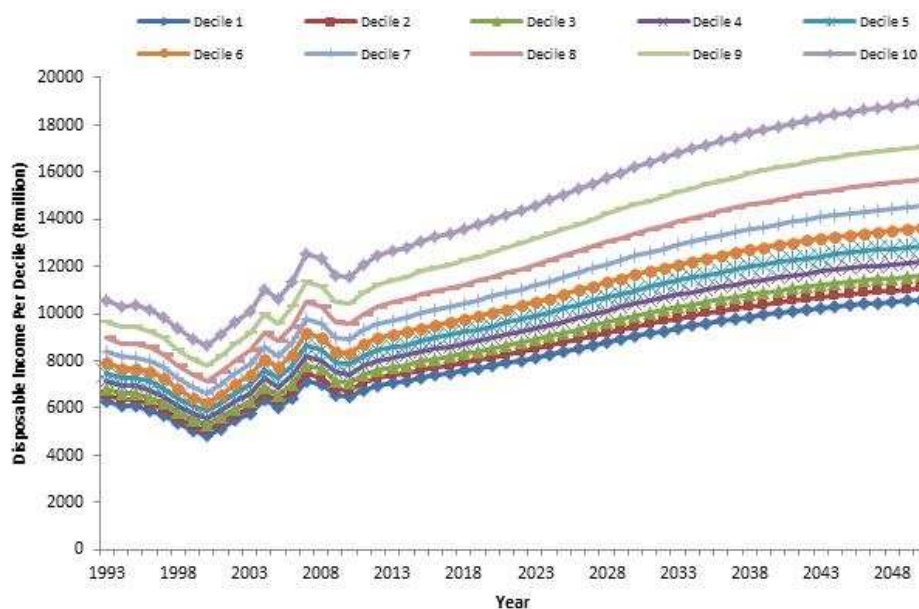

Figure 6.3: Real Disposable Incomes on a Provincial Level

Also notable is that the richer (higher deciles) households allocate higher proportions of the expenditures to luxuries, so it is expected that if the wealth in the higher deciles increases, then the expenditure on luxury goods such as electric vehicles will increase.

Figure 6.4 illustrates the income distribution per decile on a national level in South Africa. In South Africa, 62.3% of households fall within the poorest income bracket while the middle income group makes up 26.4% of households and the wealthiest households account for 1.2%; with the low income groups spending 11-12% on transport, the middle income group spends 15-19% and the high income group spends about 30% on transport (Hunter, 2016). The top quintile in South Africa earns 40 times more than the lowest quintile (roughly four

times more than in Mexico), according to the OECD, who have described South Africa as a high income inequality country with a slowing economy. Based on the results in Figure 6.4, it would appear as if the gap between the highest income decile and the lowest remains at 44% until the end of the simulation period.



**Figure 6.4: Real Disposable Incomes on a National Decile Level**

Studies have found that the highest income decile 10, nationally, is dominated by Gauteng (40%), while KZN and the Western Cape make up another 43% of that income group (Smith, 2016).

#### **6.4 Vehicle Purchases and Linkage to Consumer Affordability**

To determine the BEV market penetration rates and substitution with ICEVs, it was necessary to establish the actual number of registered ICEVs and the number of ICEVs, which would have been expected based on disposable income and affordability.

Scenarios were run to understand the inter-provincial distribution of registered passenger internal combustion engine vehicles based on empirical historical data and projections of the future trends, and this will be referred to as *Actual* ICEVs. Thereafter, scenarios were run to determine the number of ICEVs which could be afforded as a function of disposable income per province, this will be referred to as *Affordable* ICEVs.

Figure 6.5 shows the Actual ICEV registrations per province up until 2016 (ArriveAlive, 2017), thereafter projected until 2063. It is seen that Gauteng has the largest concentration of ICEVs, followed by the Western Cape and KwaZulu Natal. The lowest number of ICEVs is in the Northern Cape, followed by Free State and the North West.

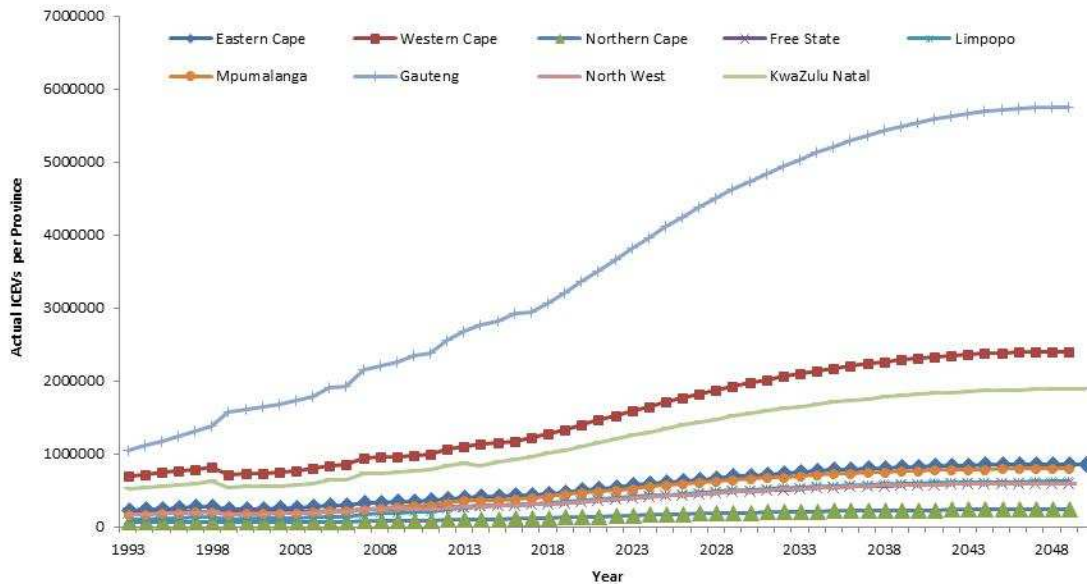

**Figure 6.5: Provincial Distribution of Actual ICEVs (No BEVs)**

The cumulative number of Actual ICEVs at the end of the simulation timeframe was projected to be 4.165 mill for Gauteng province, 1.738 mill for the Western province, 1.369 mill for KwaZulu Natal province, 0.625 mill for the Eastern Cape province, 0.583 mill for Mpumalanga, 0.452 mill for Limpopo province, 0.438 mill for North West province, 0.436 mill for Free State province and 0.177 mill for the Northern Cape province. Table 6.2 shows the average number of Actual ICEVs per period per province.

Gauteng province has about 23 times more ICEVs than Limpopo province (which has the lowest), while the Western Cape province is about 11 times more than Limpopo province and KwaZulu Natal is about 8 times more.

Studies show a strong correlation between disposable income and the use/access to vehicles for travel, especially households earning more than R3000 per month (Lombard, Cameron, Mokonyama, & Shaw, 2007). Average car ownership is more than double in Gauteng compare to the rest of the provinces.

**Table 6.2: Average Number of Actual ICEVs per Period per Province**

Average No. of ICEVs per province	1993-2000	2001-2010	2011-2020	2021-2030	2031-2040	2041-2050
Eastern Cape	257,760	300,527	311,789	324,950	338,737	352,725
Western Cape	751,403	865,079	890,945	921,782	954,547	988,598
Northern Cape	67,438	78,472	81,522	85,558	90,056	93,952
Free State	207,814	226,674	232,713	240,399	248,625	257,080
Limpopo	122,312	159,274	169,186	182,057	196,133	211,178
Mpumalanga	191,115	233,343	244,923	259,920	276,403	291,800
Gauteng	1,311,789	1,967,186	2,040,774	2,128,674	2,222,934	2,320,963
North West	186,537	218,331	224,815	232,743	241,107	249,678
KwaZulu Natal	569,609	661,580	683,635	711,104	740,858	765,349

Research indicates that the use of cars is significant for work commuting compared to other purposes and provinces such as Gauteng and the Western Cape have showed an increase in job opportunities, hence a possible increase in the number of commuters using passenger vehicles (Lombard, Cameron, Mokonyama, & Shaw, 2007). Figure 6.6 shows the difference between the Affordable ICEVs (from the simulated calculations) and the Actual ICEVs on a national level, from 1993 until 2050.

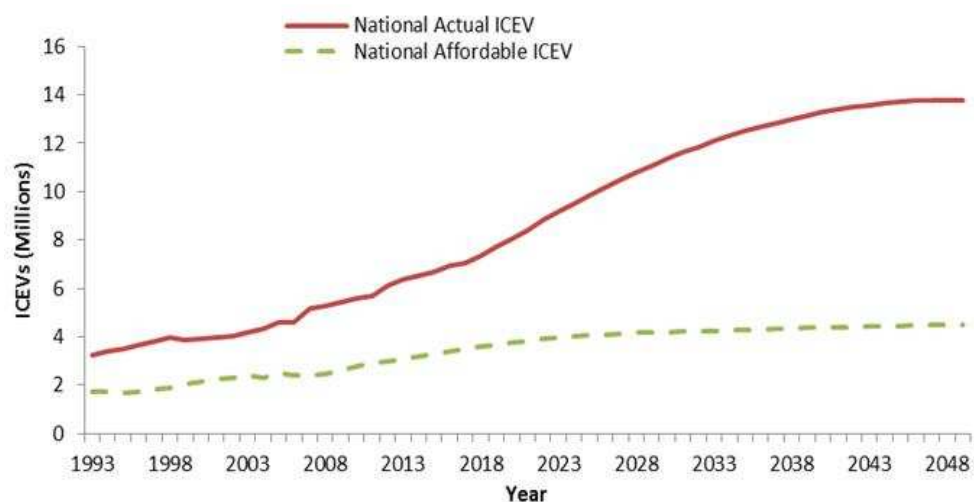
**Figure 6.6: Actual and Affordable ICEVs from 1993-2050**

On a national level, it would appear that South Africans are living beyond their “income” constraints and purchasing far more vehicles than what their disposable income allows, with



the situation worsening over time. The gap between Actual in 1993 was 46% and by 2018 increased by 50% with an expected 67% more Actual ICEVs than Affordable ICEVs by 2050, based on Figure 6.6.

There could be many reasons for this difference including access to many readily available vehicle finance schemes. The common methods for vehicle financing include balloon payments (which allows for reduced monthly instalments for the period of the credit agreement with an inflated final instalment due to the capital amount not being settled), fixed interest rates (credit agreement linked to the dynamic change in the prime interest rate) and instalment sale agreements (credit agreement that allows consumers to spread the capital amount plus interest over a set period).

Balloon payments result in the biggest final repayment amount compared to the other 2 finance methods, concluded from studies by Mothibi (2015). WesBank in South Africa, report that their balloon payments were 18% of total car sale agreements in March 2015 and are increasing by 13% annually on a national level (WesBank, 2017), which will certainly contribute towards the projected increased gap between Actual and Affordable ICEVs. The reason for buying more than we can afford is explained as “*new consumerism*” by Schor (2011), where consumer satisfaction is based on socially formed lifestyle aspirations and expectations, thus participating in what is known as upscale spending (where consumers choose reference groups whose incomes are much higher just to copy the consumption patterns, especially those of celebrities) (Murphy, 2016).

Figure 6.7 shows the provincial average differences between the Actual and Affordable ICEVs for various periods: 2001-2010, 2011-2020, 2021-2030, 2031-2040 and 2041-2050.

Gauteng province has the highest average difference between Actual and Affordable ICEVs by 2050 (4.252 mill), followed by the Western Cape province (1.545 mill) and KwaZulu Natal province (1.174 mill). All the other provinces have smaller differences between the Actual and Affordable ICEVs (between 0.108 mill and 0.519 mill).



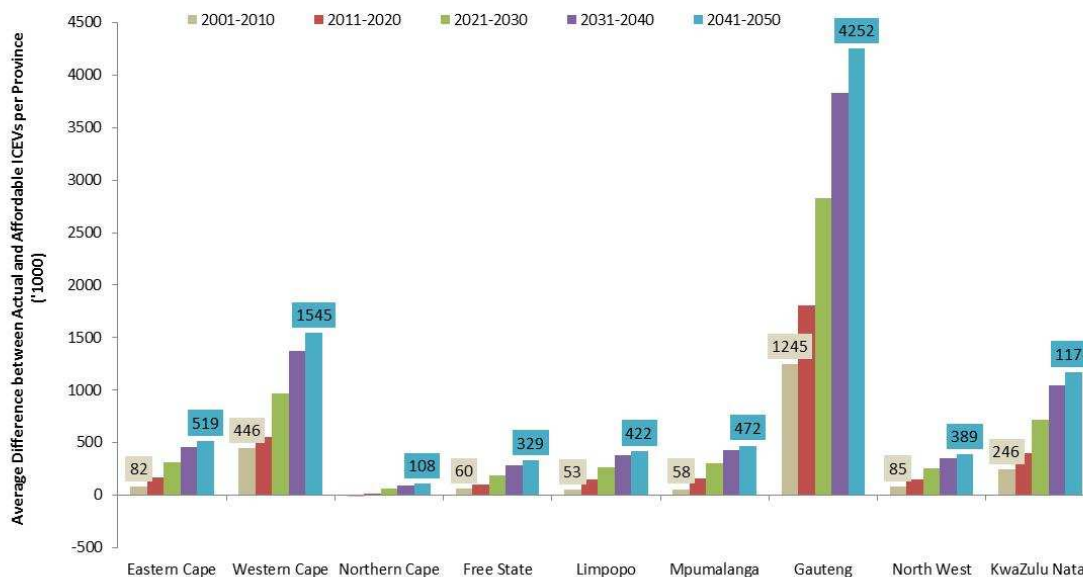

**Figure 6.7: Provincial Average Differences between Actual and Affordable ICEVs for 10 Year Periods**

Table 6.3 shows the provincial average number of ICEVs per 1000 people assuming all passenger vehicles.

**Table 6.3: Average ICEVs per 1000 people (2016, 2030 and 2040)**

Average No. of ICEVs per 1000 people	2016	2030	2040
Eastern Cape	63	86	91
Western Cape	191	262	277
Northern Cape	103	142	150
Free State	108	149	157
Limpopo	54	74	79
Mpumalanga	91	128	135
Gauteng	218	294	310
North West	84	111	118
KwaZulu Natal	86	118	125
National Average	111	152	160

Based on E-StratBEV calculations, the national average number of ICEVs per 1000 people in 2016 was 111 and expected to increase to 152 ICEVs per 1000 people in 2030 and 160 ICEVs per 1000 people by 2040.

Studies by Dargay & Gately (1997) indicate, through the development of an econometric car ownership model, that there is a long-term relationship between per capita car ownership and per capita income which follows a Gompertz curve (similar to the logistic S-curve, but with a slower rate of saturation). Venter and Mohammed (2013), through the development of a multinomial logit model of vehicle ownership, explains that high-income households would make vehicle purchase decisions irrespective of the number of dependents in the household. Guerra (2015) suggests if a household's income were to double then the household would be 44% more likely to get an additional car.

On a national income decile level (Figure 6.8), the Actual number of ICEVs is higher than the Affordable number of ICEVs; however, the highest difference is for the wealthiest income group (decile 10) and the lowest variance is for the lowest group (decile 1).

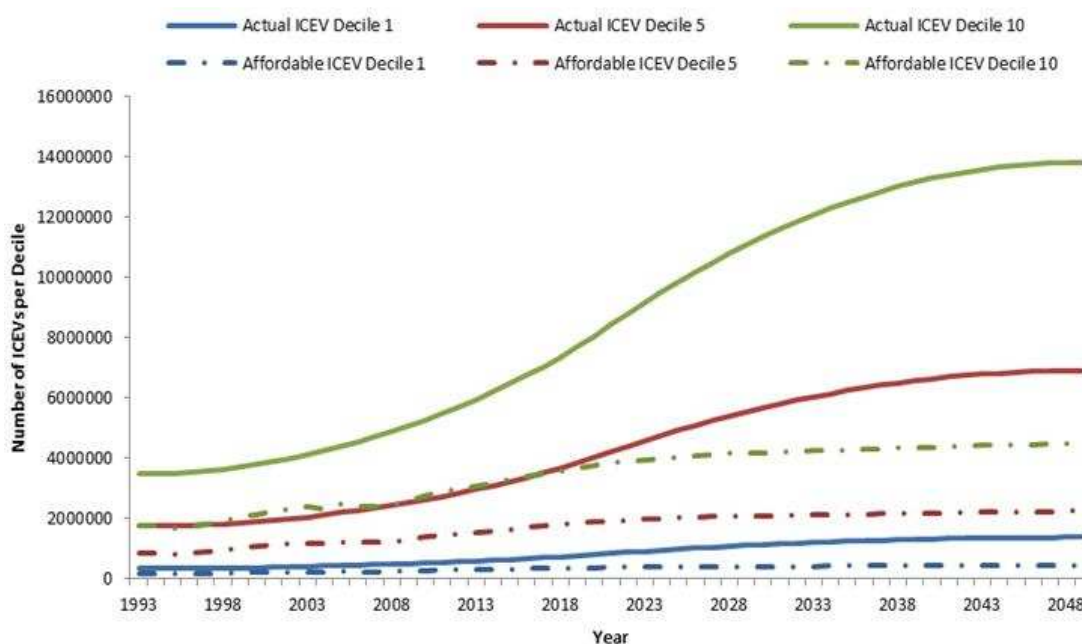

**Figure 6.8: National Number of Actual & Affordable ICE Motor Vehicles (Deciles 1, 5 & 10)**

Middle class income groups (decile 5) seem more susceptible to upscale spending (Silverstein, Fiske, & Butman, 2003), hence there is an expectation for widening the gap between Actual ICEVs and Affordable ICEVs as well.

The highest income groups appear to spend a lot of their income on buying property and businesses, and high-end luxury vehicles such as Porsches, Bentleys and Maserati's

(AFRASIA, 2017). With an influx of BEV luxury vehicles, it would be expected that the higher income groups would be likely to purchase these even without incentives, since research shows that affluent groups are less or not at all affected by economic downturns, and instead by exclusivity, functionality and quality of luxury goods (Gardyn, 2002). This also means that the disposable income cannot be used as a proxy to indicate affordability of vehicles in the high income groups since purchases are far likely to be financed through gains from financial investments.

## 6.5 BEV Distributions Based on Gross Domestic Profit, Disposable Income and ICEVs Fractions

This research objective was to determine the influence of various parameters on the provincial BEV distributions. The parameter fraction was important since it would affect the carbon emissions calculations and the residential electricity consumption calculations on a provincial level.

The parameter fractions included GDP (ACEA, 2017), disposable income (Occams Business Research and Consulting, 2017), and ICEV fractions. An indication of this difference in BEV provincial distributions for the Low Growth BEV scenario due to the various fractions in 2040 is shown in Table 6.4.

**Table 6.4: BEVs per province in 2040 for Various Parameter Fractions**

	Disposable Income Fraction	GDP Fraction	ICEV Fraction
Eastern Cape	19,440	17,617	14,626
Western Cape	48,062	32,220	40,678
Northern Cape	22,407	5,140	4,136
Free State	21,239	12,220	10,211
Limpopo	17,056	16,870	10,584
Mpumalanga	23,178	16,916	13,645
Gauteng	41,753	81,123	97,479
North West	18,739	14,346	10,257
KwaZulu Natal	21,776	37,220	32,033

If the GDP parameter fraction was used for the BEV provincial distributions, then the highest number of BEVs in 2040 would be for the Gauteng province (81,123), followed by KwaZulu Natal (37,220) and then the Western Cape province (32,220). If it was based on disposable income fractions then the Western Cape province would have 48,062 BEVs compared to

Gauteng province which would have 41,753 BEVs and KwaZulu Natal with 21,776 BEVs. Using the ICEV fractions within the provinces, the Gauteng province would have 97,479 BEVs followed by the Western Cape province with 40,678 BEVs and then KwaZulu Natal with 32,033 BEVs in 2040.

For this study, GDP was used to make the provincial distributions due to BEVs still being classified as luxury goods. If incentives were already in place to make BEVs more affordable then disposable income could have been used as a measure. By using the GDP parametric for the provincial distribution of BEVs, it is assumed that BEVs remain a luxury item for the simulation timeframe; with BEV drivers and incentives requiring extensive time for government, private and public sector negotiations. If incentives and drivers were introduced, especially with the aim of resolving the cost disparity between ICEVs and BEVs, then the provincial distributions would then follow the disposable income fractions. Debates are still in progress as to how to create a market in South Africa to encourage localisation for the EV manufacturing market, while not stifling the stimulus for growth for imported vehicles (Cokayne, 2018) and until a resolution is obtained, it is assumed that BEVs will remain a luxury vehicle and GDP can be used to understand provincial propensities to absorb BEVs. Provincial distributions were made for the Low Growth BEV scenario (233,700 BEV substitutions of ICEVs between 2019 and 2040) and for the High Growth scenario (2,390,193 BEV substitutions of ICEVs between 2019 and 2040) shown in Figure 6.9.

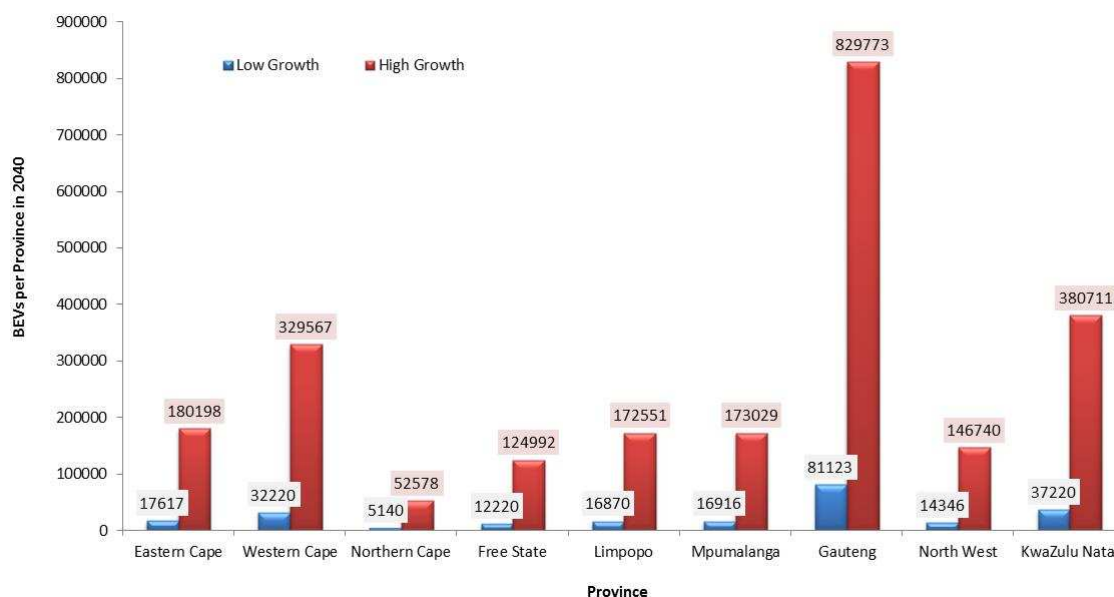
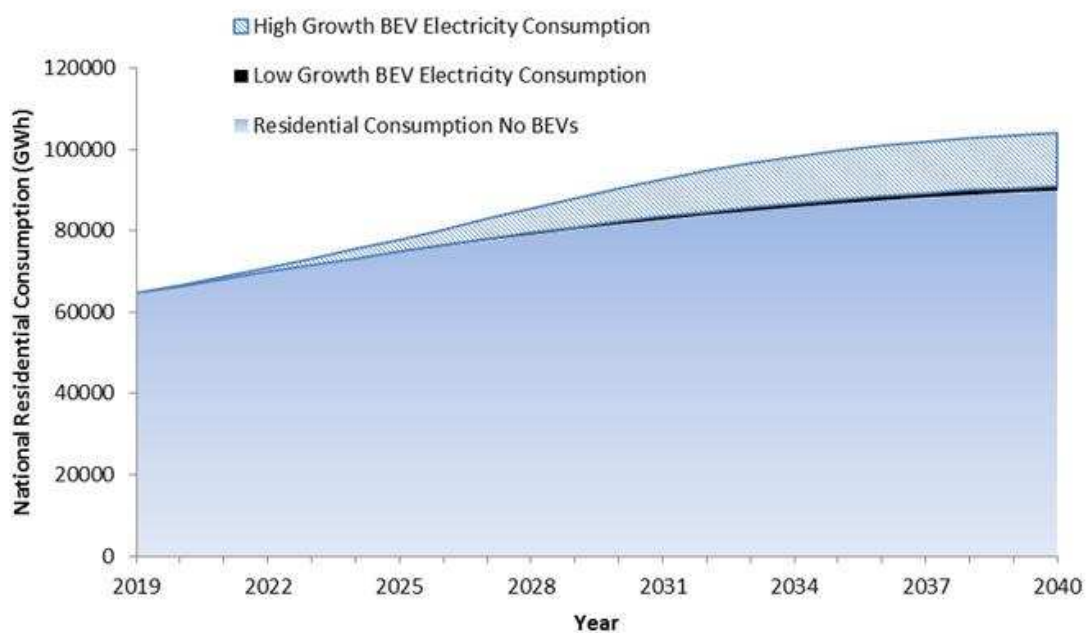

**Figure 6.9: Low Growth and High Growth BEV Distributions per Province in 2040**

The highest expected BEV targets by 2040 would be for the Gauteng province (81,123 Low Growth scenario and 829,773 High Growth scenario); then KwaZulu Natal province (37,220 Low Growth and 380,711 High Growth) and the Western Cape province (32,220 Low Growth scenario and 329,567 High Growth scenario). The lowest expected BEV targets by 2040 would be for the Northern Cape province (5,140 Low Growth scenario and 52,578 High Growth scenario).

## 6.6 Impact of Battery Electric Vehicle Market Penetration on Residential Electricity Consumption

*PlugInsights* surveyed vehicle charging sites of 3,247 electric vehicle owners and results show that 7% of charging takes place at work, 10% of charging occurs at public charging stations and 81% takes place at home (InsideEVs, 2013). Figure 6.10 shows the national residential electricity consumption without BEVs and then for the Low Growth and High Growth BEV target impact on residential electricity consumption assuming all power is supplied through the electricity network, and 81% of the BEV charging is done at home.



**Figure 6.10: Impact of BEV Targets on Residential Consumption from 2019 until 2040**

The E-StratBEV simulator results in Table 6.5 shows the Low Growth and High Growth BEV scenario impacts on the national residential electricity consumption for years 2019, 2030 and 2040, assuming 81% of the charging is done at home, using the electricity network.

**Table 6.5: Impact of BEV Targets on Residential Electricity Consumption (2019, 2030 and 2040)**

BEV Target Impact on Residential Electricity Consumption (% increase)	2019	2030	2040
Low Growth	0.02%	0.98%	1.41%
High Growth	0.17%	10%	14.46%

For the High Growth scenario, BEVs results in an increase of ~14.46% in residential electricity consumption by 2040 and have a negligible impact for the Low Growth scenario. For the Low Growth scenario, BEV drivers add a further cumulative total of 270 GWh from 2019 until 2040 while the High Growth BEV drivers add a further 2,764 GWh to the residential consumption.

Figure 6.11 shows the provincial cumulative residential electricity consumption from 2019 until 2040 for the Low Growth and the High Growth BEV scenarios, compared to the residential consumption with no BEVs. Gauteng province has the highest BEV impact on residential consumption, with an additional 43,898 GWh for the High Growth scenario or 4,291 GWh with the Low Growth, followed by KwaZulu Natal province, with an additional 20,140 GWh for the High Growth scenario or 1,969 GWh with the Low Growth, then the Western Cape, with an additional 17,435 GWh for the High Growth scenario or 1,704 GWh with the Low Growth.

Figure 6.12 shows the geographic provincial Low Growth BEV scenario for residential electricity consumption in 2019, 2030 and 2040. Figure 6.13 shows the geographic provincial High Growth BEV scenario for residential electricity consumption in 2019, 2030 and 2040.

The national residential consumption total for the Low and High growth scenarios is summarised in Table 6.6.

**Table 6.6: National Residential Electricity Consumption (TWh)**

Residential Consumption (TWh) Per Year	2019	2030	2040
Low Growth	0.01	0.80	1.27
High Growth	0.11	8.17	13.01

### **6.6.1 BEV Impact on Reserve Margin with Changing Generation Supply Mix**

Scenarios were run to understand the change in the expected energy and capacity reserve margins in 2030 and 2040, as a function of the generating supply mix. In 2030, there was a high energy reserve margin (23.36%) for both the coal and the renewables heavy supply mixes, meaning that the country's requirement for energy can be met, even with some periods of shortfall and excess energy, since these would possibly average out. In 2030 the capacity reserve margins were low (5.58% for the coal heavy supply mix and 9.26% for the renewables heavy supply mix) indicating that there may not be enough power (MW) to meet the evening and morning peak demand despite a positive average energy reserve margin. In 2040, this improved to a reliable capacity outlook with the high capacities included in the future supply plans especially for renewables (18.17% for the coal heavy supply mix and 21.85% for a renewables heavy supply mix). If the weighted average cost of electricity is considered for the different electricity generation mixes, a renewables heavy mix could potentially result in a 40% higher cost of electricity by 2040 than a coal heavy generation mix, although it appears a better choice for climate change mitigation.

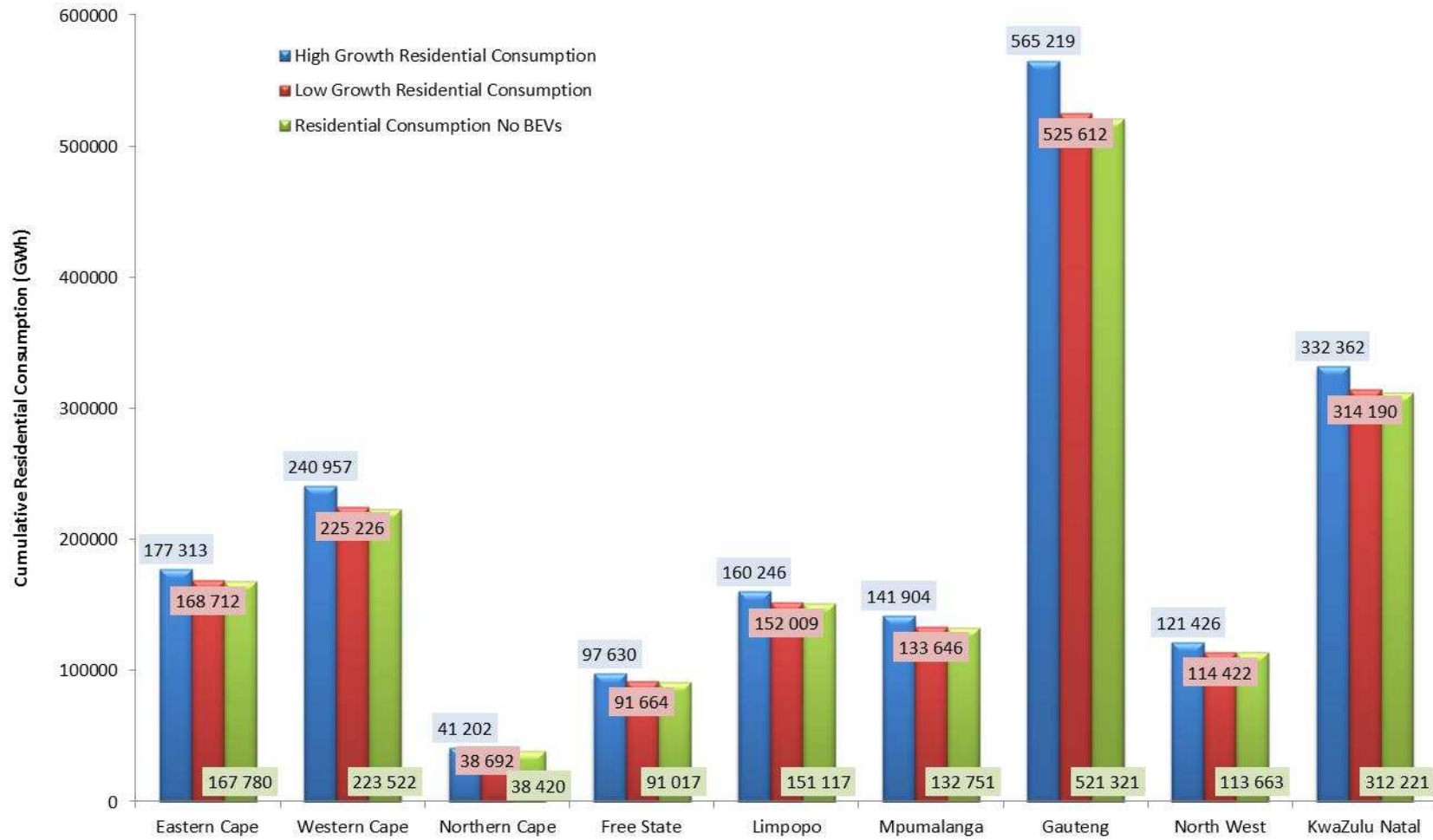

Figure 6.11: Cumulative Provincial Residential Electricity Consumption (GWh) from 2019 until 2040



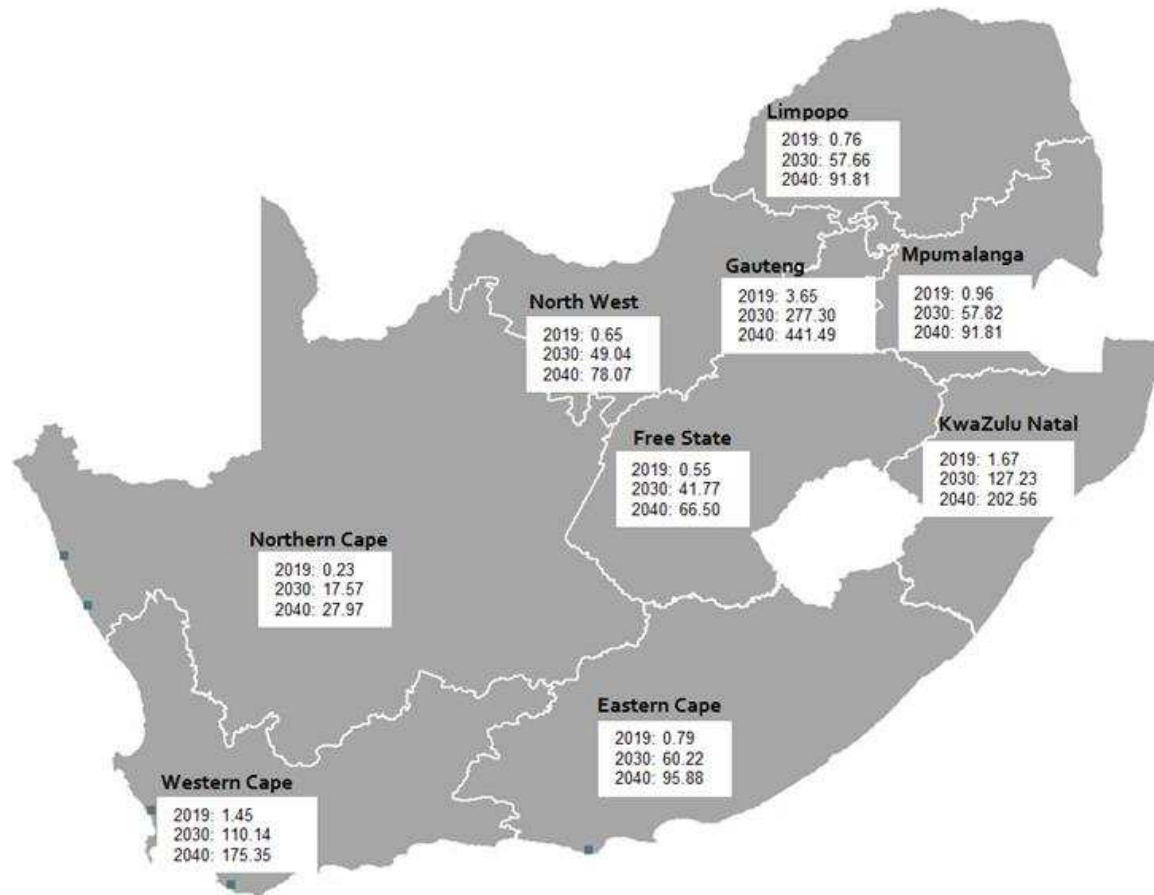

Figure 6.12: Low Growth Scenario: BEV Electricity Consumption (GWh) in 2019, 2030 and 2040

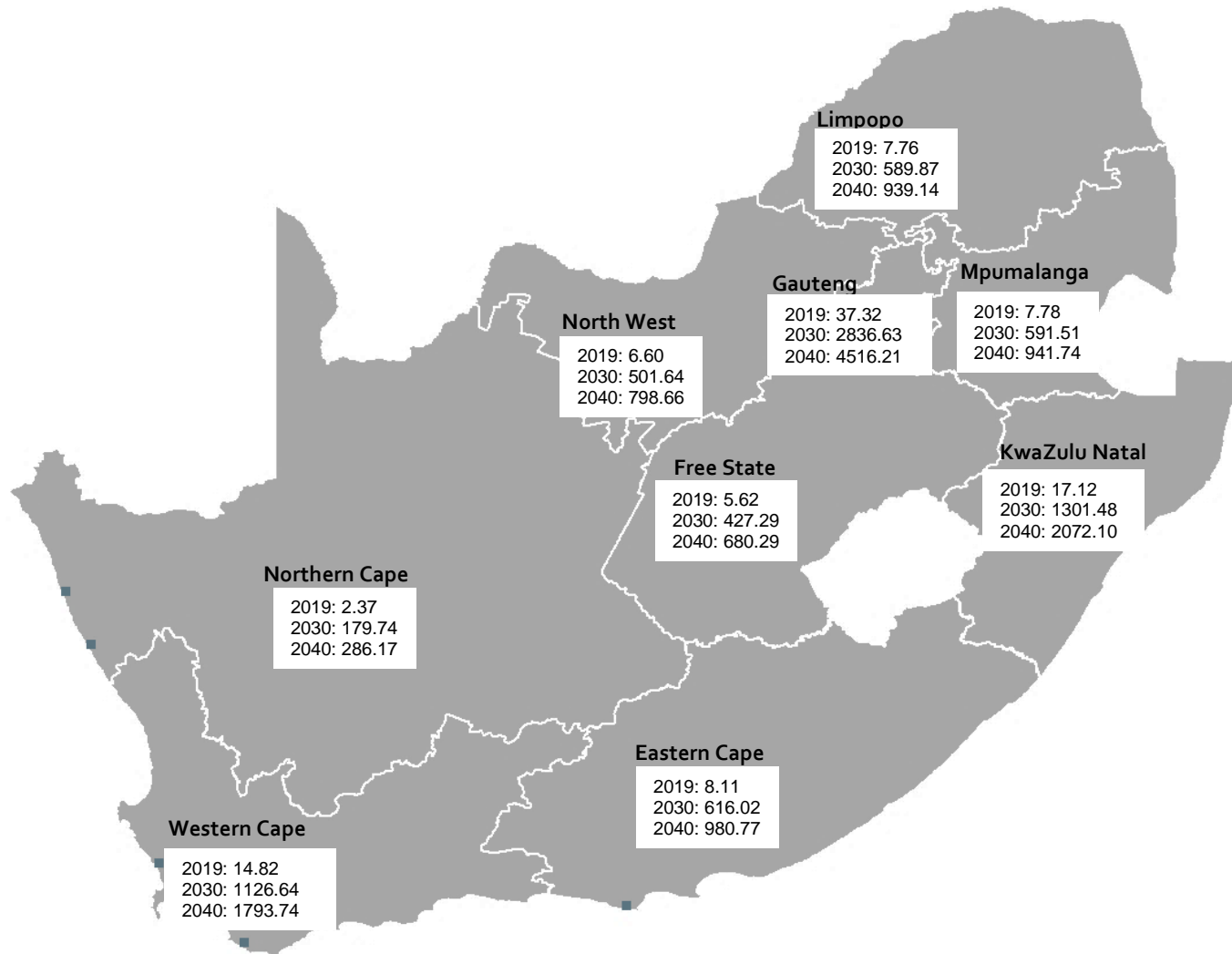

Figure 6.13: High Growth Scenario: BEV Electricity Consumption (GWh) in 2019, 2030 and 2040

## 6.7 Key Drivers Impacting BEV Market Penetration

BEV drivers were limited to include charging infrastructure, purchase price, range anxiety and reputation effect based on the feedback from the drivers who participated in the Eskom Nissan BEV pilot study (Langley, 2016).

Table 6.7 indicates the total number of BEVs from 2019 until 2040 for the Low Growth and High Growth scenarios, and then with the additional BEVs due to driver impact. Driver impact on BEV market penetration introduces an additional 1,589 BEVs for the Low Growth scenario from 2019 to 2040 while driver impact on BEV market penetration for the High Growth scenario introduces an additional 16,257 BEVs in the same period.

**Table 6.7: BEV Market Penetration with Drivers**

Scenario	Low Growth BEVs	High Growth BEVs
BEVs no Driver Impact	233,700	2,389,950
Driver Specific BEVs	1,589	16,257
Total BEVs with Drivers	235,289	2,406,157

Figure 6.14 shows the individual impact of each of the drivers on the Low Growth and the High Growth scenarios.

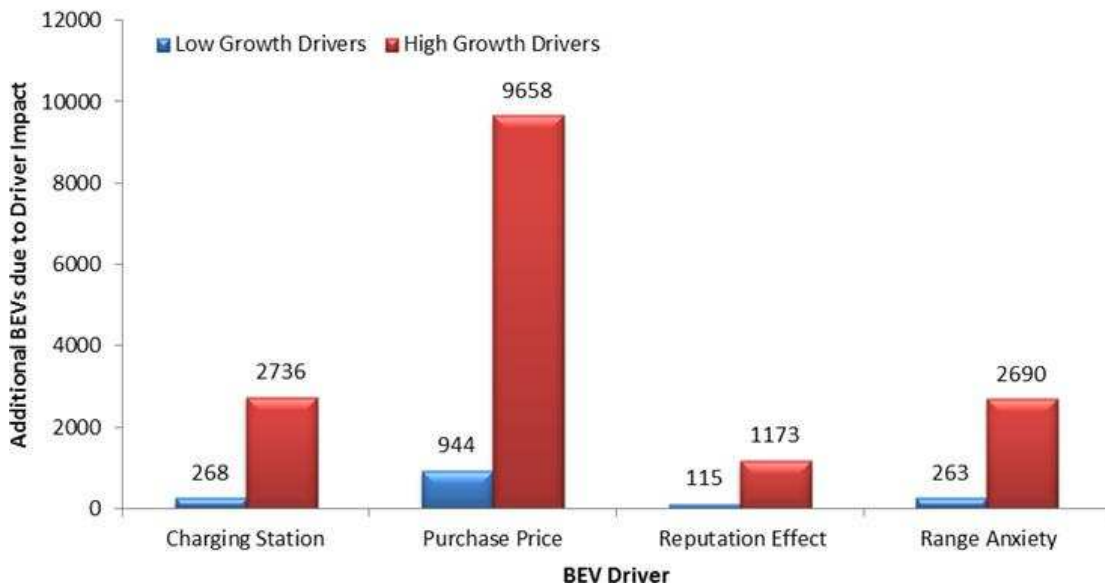

**Figure 6.14: BEV Distributions according to BEV Driver Influences (2019-2040)**

Harrison and Thiel (2017) concluded that fiscal incentives which relate to lowering the purchase price is required to encourage early adopters to EV technology, setting the scene

for the successful pre-mass market penetration of BEVs. Results from the E-StratBEV show that the decrease in BEV purchase price, to bring it on par with its ICEV counterpart, results in the largest number of additional BEVs (944 for the Low Growth scenario and an additional 9,658 BEVs for the High Growth scenario).

Range anxiety appears to be improved either through improved BEV battery technology that increases the range or even through the increased availability of charging infrastructure, although more than one charging station per 10 plug-in EVs would result in little gains and high costs and the influence on sales would become insensitive at more than 25 plug-in EVs per charging point (Harrison & Thiel, 2017). Results from the E-StratBEV indicate a comparable number of additional driver influenced BEVs when increasing charging stations and improving range anxiety. It is ascertained that a consumer's risk tolerance for new technology is influenced by public attitudes and preferences, thus the reputation of BEVs is an important consideration which will introduce an additional number of BEVs, although not as dominant as the other driver impacts (Egbue & Long, 2012).

## **6.8 Environmental Impacts of BEVs**

South Africa is ranked among the top 20 countries in terms of absolute CO<sub>2</sub> emissions, with emissions per capita of approximately 10 metric tons per year (ITMP25). The country's energy intensity is met largely by fossil fuel generation options (Eskom, 2010). Projections of the carbon emissions from the transport sector indicate a potential doubling by 2050 (Merven et al. 2012). Although the Green Transport Strategy has various focus areas and one of these is the promotion of green transport technologies through supporting the uptake of electric and hybrid electric vehicle technologies (Khutsoane, 2016), the impact of additional electrical charging of the EVs on carbon emissions in the energy sector needs to be understood.

The results were generated using E-StratBEV for two different electricity supply mixes (one with a coal heavy future mix and one with a renewables heavy supply mix). The cumulative change in carbon emissions from 2019 until 2040 was calculated on a national level (see Table 6.8).

Results show that for both scenarios, the net decrease in CO<sub>2</sub> emissions in the transport sector due to substitution with BEVs would benefit the country if the future supply mix was largely renewable in nature as opposed to if it was coal heavy.

**Table 6.8: National Cumulative Change in Carbon Emissions (Mton)**

<b>Change in Cumulative Carbon Emissions (2019-2040)</b>	<b>(Mton)</b>
Low Growth Energy Sector (Coal)	10.04
Low Growth Energy Sector (Renewables)	7.80
Low Growth Transport Sector (Coal)	8.21
High Growth Energy Sector (Coal)	102.86
High Growth Energy Sector (Renewables)	79.16
High Growth Transport Sector (Coal)	84.98

The cumulative carbon emissions from 2019 until 2040 was calculated on a provincial level, and shown in Figure 6.15 for the Low Growth scenario. For the Low Growth scenario, the Gauteng province benefits the most with a 3.46 Mton decrease in the transport sector accompanied by a 3.47 Mton increase in the energy sector or a 2.69 Mton increase if a renewables heavy supply mix dominates the energy sector. The second highest reduction in carbon emissions in the transport sector is for the Western Cape province (1.42 Mton), followed by KwaZulu Natal province (1.13 Mton reduction). The remaining provinces have a reduction between 0.15 Mton and 0.5 Mton for the cumulative period from 2019 until 2040. The Western Cape province appears to benefit the most with a higher reduction of carbon emissions in the transport sector even in the coal heavy electricity supply mix (a small net increase of 1.31 Mton in the energy sector compared to the 1.42 Mton decrease in the transport sector).

Figure 6.16 shows the cumulative carbon emissions for the High Growth scenario from 2019 until 2040. A higher substitution of ICEVs with BEVs results in a 35.51 Mton cumulative reduction in the transport sector in the Gauteng province for the period from 2019 until 2040. The province benefitting the least through ICEV substitution with BEVs for transport sector carbon emissions reduction is the KwaZulu Natal province, and the province with the most benefit in transport related carbon emissions is the Western Cape.

On a provincial level, it would be beneficial to introduce solar recharging stations to support climate change impacts, besides migrating towards a larger fraction of renewables in the future electricity supply mix (taking cognisance of the implications on the net energy reserve margin if this is pursued). Clearly additional initiatives need to be carried out to reduce the CO<sub>2</sub> emissions, such as:

- Introducing environmentally friendly and fuel efficient aircraft (ANA Group, 2014);
- Launching more energy efficient drives such as LED lighting, energy efficient appliances, effective home and water heating. (Goodall, 2017);

- Less waste and consumption of water and an increase in recycling (Jha, 2009); and
- Continuation of climate change research and initiatives towards a clean, sustainable economy, or a green economy.

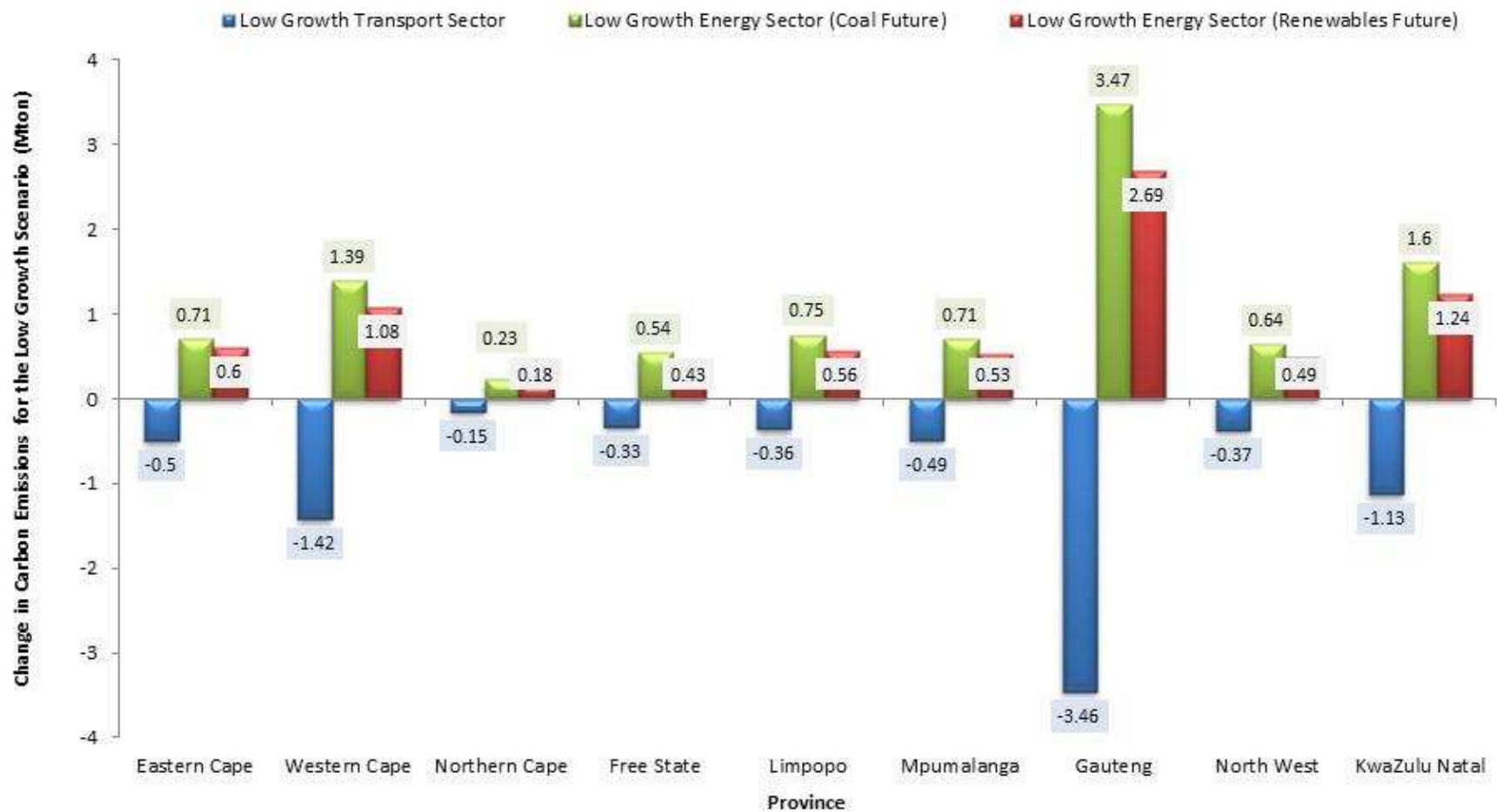

Figure 6.15: Low Growth Impact on Provincial Cumulative Carbon Emissions from 2019 until 2040

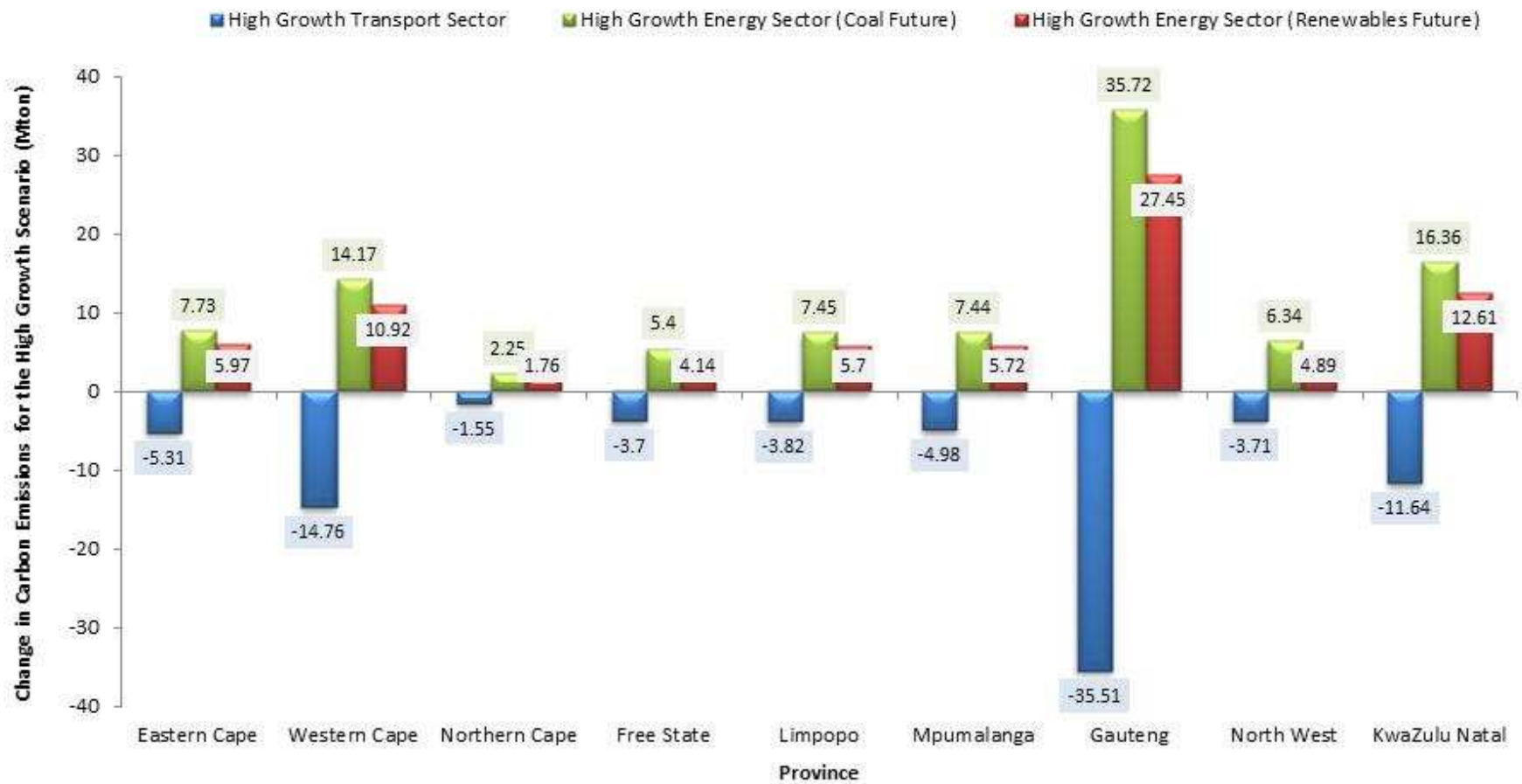

Figure 6.16: High Growth Impact on Provincial Cumulative Carbon Emissions from 2019 until 2040



## 6.9 BEV Distributions Based on Vehicle Expenditure within Deciles

The 2015 Gauteng City-region Observatory Quality of Life Survey report, showing the debt across income groups in the Gauteng province (Joseph, 2017), indicates that Gauteng is the wealthiest province with the middle and higher income groups carrying the majority of debt. Based on the StatsSA (Ruch, 2017) expenditure on vehicle purchases per income decile (nationally), deciles 1, 2 and 3 do not appear to spend income on purchasing vehicles but do spend on public transportation while decile 10 has an almost disproportionately higher percentage of income spent on vehicle purchases relative to the other deciles.

E-StratBEV was used to compare the difference in the BEV provincial distributions for the Low Growth scenario and the Low Growth scenario adjusted based on spending behaviour of the population within the various income groups (Figure 6.17).



**Figure 6.17: BEV Low Growth and Low Growth Adjusted in 2040**

If BEVs purchases align with the current practices on vehicle expenditure within deciles then the expected BEV distributions per province is lower than the expected targets. This means that nationally, although the Low Growth scenario indicates about 233,700 BEVs by 2040, an adjusted estimation based on the spending behaviour within deciles, results in 44,155 BEVs.

Figure 6.18 compares the difference in the BEV provincial distributions for the Low Growth scenario and the Low Growth scenario adjusted based on vehicle spending behaviour of the population within the various income groups. The High Growth scenario has an expected 2,389,950 BEVs by 2040 but the adjusted number is 451,736 BEVs.

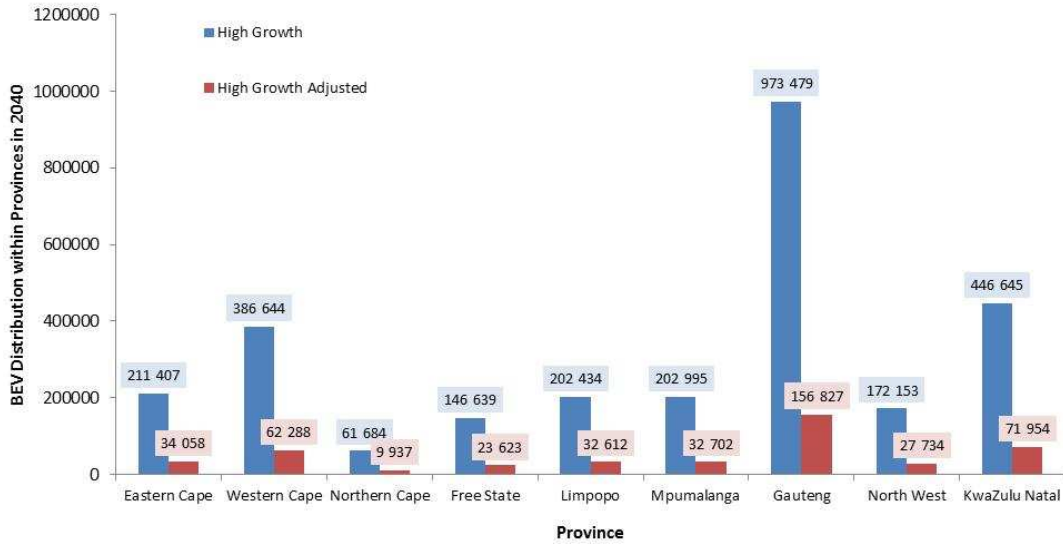

**Figure 6.18: BEV High Growth and High Growth Adjusted in 2040**

Based on vehicle spending behaviour, the distributions expected within each decile per province for the Low Growth and High Growth BEV scenarios by 2040 is reflected in Figures 6.19-6.24. Figure 6.19 shows Gauteng’s decile 10 expected to purchase the highest number of BEVs, 9,733 BEVs for the Low Growth scenario and 99,573 for the High Growth scenario, contributing to the Low Growth BEV total of 28,035 and to the High Growth BEV total of 286,816 for decile 10.

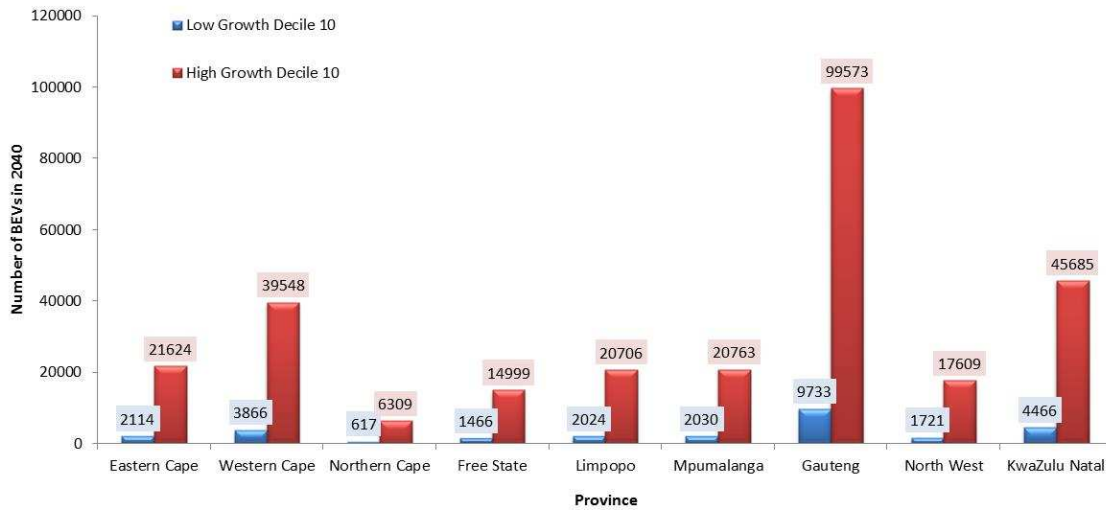

**Figure 6.19: Decile 10 - Low and High Growth BEV Adjusted to Expenditure Deciles in 2040**

Figure 6.20 shows decile 9 purchasing a total of 8,644 BEVs for the Low Growth scenario and 88,435 BEVs for the High Growth Scenario.

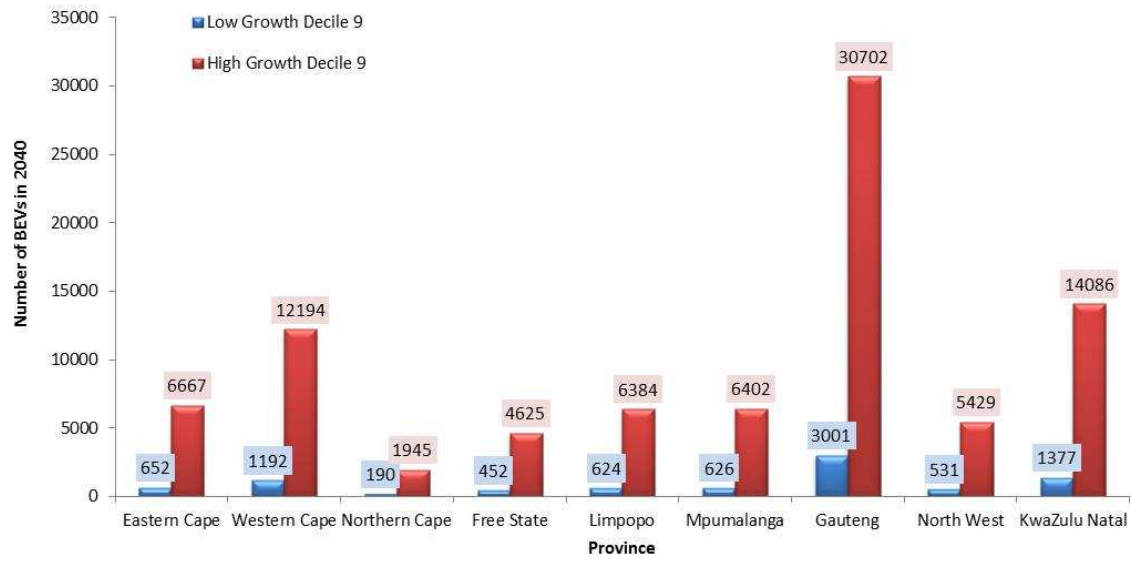

**Figure 6.20: Decile 9 - Low and High Growth BEV Adjusted to Expenditure Deciles in 2040**

Figure 6.21 shows a total of 4,205 BEVs for the Low Growth scenario and 43,023 BEVs for the High Growth scenario for decile 8.

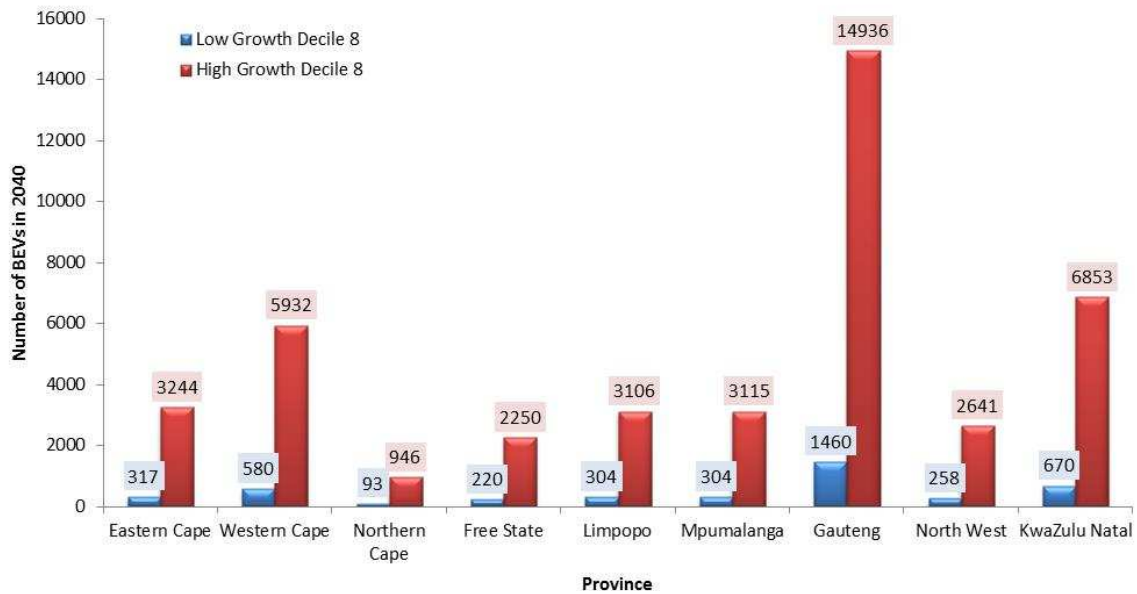

**Figure 6.21: Decile 8 - Low and High Growth BEV Adjusted to Expenditure Deciles in 2040**

Figure 6.22 shows a total of 2,102 BEVs for the Low Growth scenario and 21,511 BEVs for the High Growth scenario for decile 7.

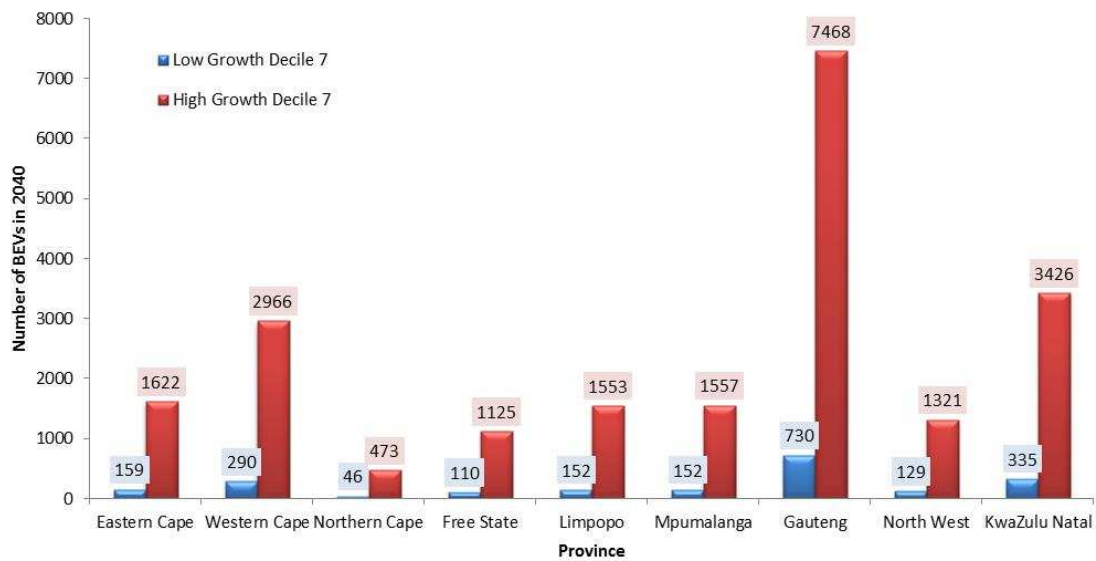

**Figure 6.22: Decile 7 - Low and High Growth BEV Adjusted to Expenditure Deciles in 2040**

Figure 6.23 shows a total of 701 BEVs for the Low Growth scenario and 7,170 BEVs for the High Growth scenario for decile 6.

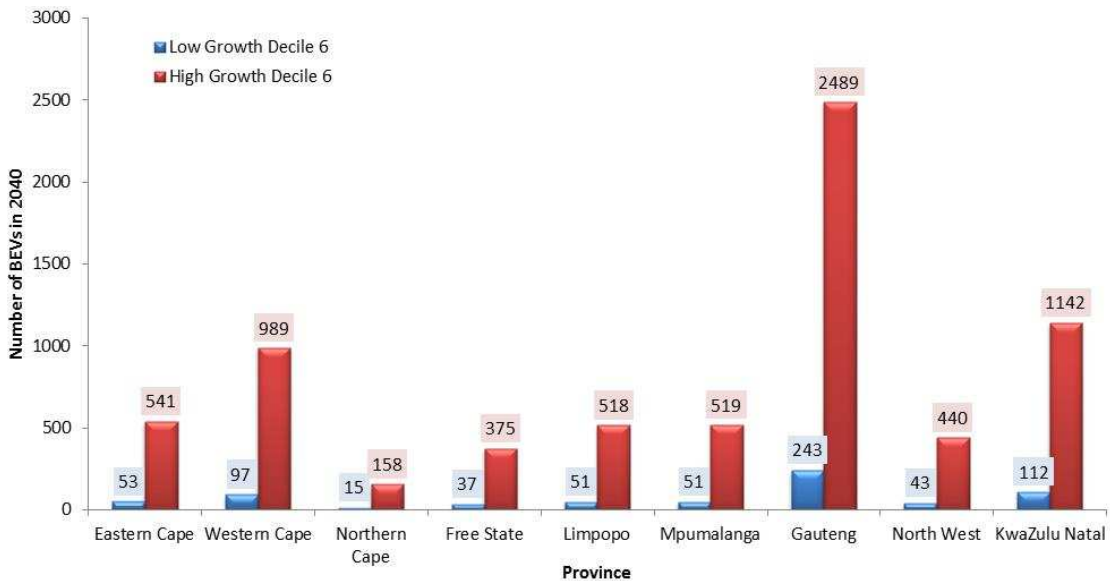

**Figure 6.23: Decile 6 - Low and High Growth BEV Adjusted to Expenditure Deciles in 2040**

Figure 6.24 shows a total of 234 BEVs for the Low Growth scenario and 2,390 BEVs for the High Growth scenario for decile 4 and the same for decile 5.

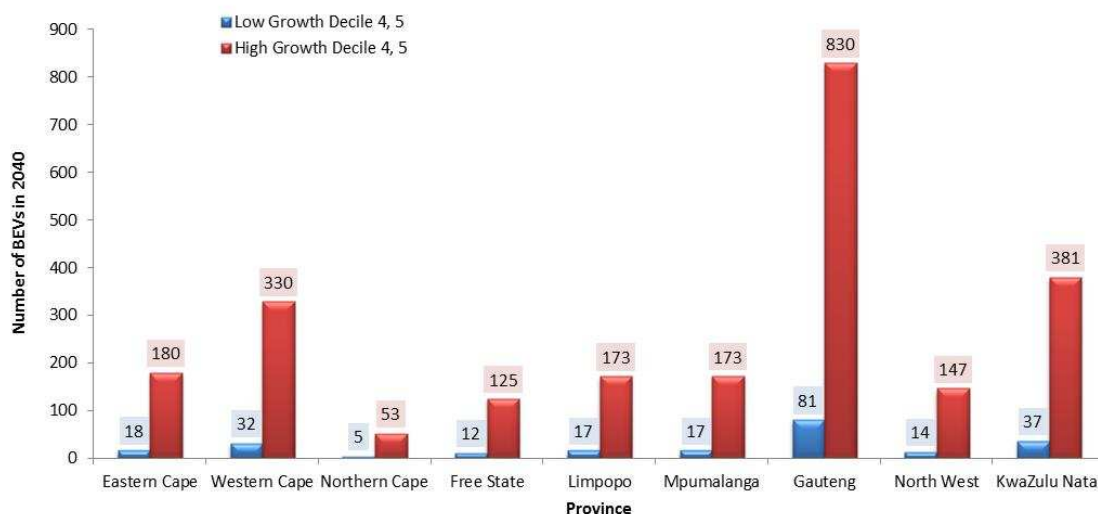

**Figure 6.24: Deciles 4 & 5 - Low and High Growth BEV Adjusted to Expenditure Deciles in 2040**

On a decile level and on a provincial level, Gauteng province dominates with the most vehicle purchases followed by the KwaZulu Natal and Western Cape provinces. BEV sales will be influenced significantly by deciles 8, 9 and 10.

## 6.10 Summary

This chapter detailed the results obtained from the E-StratBEV scenarios to answer the research objectives. The key outcomes include the following:

- A Low Growth scenario of 233,700 BEVs and a High Growth scenario with 2,389,950 BEVs, from 2019 until 2040.
- Doubling the GDP resulted in a 1.1% increase in residential consumption, while an improvement to attain the targeted 0.59 Gini coefficient in the National Development Plan results in a 5.4% increase in residential consumption, thus energy planners should consider the impact of income distribution.
- After using disposable income to calculate the Affordable number of ICEVs, and comparing it to the Actual registered ICEVs, it would appear that South Africans are living beyond their “income” constraints and purchasing far more vehicles than what their disposable income allows, with the situation worsening over time. The gap between

Actual and Affordable ICEVs in 1993 was 46% and by 2018 increased by 50% with an expected 67% more Actual ICEVs than Affordable ICEVs by 2050. One reason for this gap in the middle income group is because consumers have easy access to vehicle financing schemes including balloon payments, which are increasing annually by 13% indicating a continuation of spending beyond financial constraints, and their propensity for upscale spending. The high gap between the Actual and Affordable ICEVs in the high income group is a misnomer and would not accurately reflect affordability of vehicles since vehicles are more likely financed from investments and not monthly disposable income cash flow.

- d) GDP was used to make the provincial distributions due to BEVs still being classified as luxury goods. If incentives were already in place to make BEVs more affordable then disposable income could have been used as a measure.
- e) Driver impact on BEV market penetration introduced an additional 1,589 BEVs for the Low Growth scenario from 2019 to 2040 while driver impact on BEV market penetration for the High Growth scenario introduced an additional 16,257 BEVs in the same period. If the purchase price parity is obtained, the largest number of additional BEVs due to driver impact would be 944 for the Low Growth scenario and an additional 9,658 BEVs for the High Growth scenario.
- f) For the High Growth scenario, BEVs resulted in an increase of ~14.46% in residential electricity consumption by 2040 and had a negligible impact for the Low Growth scenario. For the Low Growth scenario, BEV drivers added a further cumulative total of 270 GWh from 2019 until 2040 while the High Growth BEV drivers added a further 2,764 GWh to the residential consumption.
- g) For a coal heavy supply mix, the cumulative carbon emissions from 2019 until 2040, for the Low Growth scenario resulted in an increase of 10.04 Mton in the electricity sector and a 8.21 decrease in the transport sector; while for a renewables heavy supply mix, the cumulative carbon emissions for the Low Growth scenario resulted in an increase of 7.8 Mton in the electricity sector.

The High Growth scenario resulted in 102.86 Mton cumulative carbon emissions in the electricity sector for a coal heavy supply mix and 79.16 Mton for a renewables heavy supply mix, compared to a decrease of 84.98 Mton in the transport sector. The net decrease in CO<sub>2</sub> emissions in the transport sector due to substitution with BEVs would

benefit the country if the future supply mix was largely renewable in nature as opposed to if it was coal heavy. However, the renewables heavy supply mix does not consider the weighted average cost of electricity with the supply mix or technology costs or grid integration impacts and although it appears a better choice, all factors have to be considered in changing the electricity supply mix. By 2040, a renewables heavy mix could potentially result in a 40% higher weighted average cost of electricity than a coal heavy generation mix.

- h) If BEVs purchases align with the current practices on vehicle expenditure within deciles then the expected BEV distributions per province was lower than the expected targets. This means that the Low Growth scenario would have to be adjusted from 233,700 BEVs by 2040 to 44,155 BEVs while the High Growth scenario would have to have a BEV correction of 2,389,950 BEVs by 2040 to 451,736.

# Chapter 7: Summary of Findings, Validation of Contribution, Limitations and Opportunities for Further Research

---

## 7.1 Overview

The use of the system dynamics methodology to develop E-StratBEV allowed sensitivity and scenario analysis of hundreds of causally linked quantitative dependencies, and allowed the structural linkage of feedback loops involved in additional BEVs due to the various drivers. This Chapter provides the validation of the contribution, summary of findings, limitations of the study, and identifies opportunities for future research. The research assisted with understanding the causal effect of income distribution, disposable income and affordability on vehicles purchases and the related impact on residential electricity consumption and carbon emissions on a provincial level. This would support the development of strategic energy plans and EV charging infrastructure plans, which can factor in the regional variations in BEV demand.

## 7.2 Summary of Findings

### 7.2.1 System Dynamics Modelling Process

After reviewing various modelling methods that have been used to understand BEV dynamics, it was clear that the modelling approach incorporating feedback loops and which would allow for the non-linear mathematical causal linkages of a wide spectrum of variables was required. This would support an in-depth understanding of the impact of the market penetration rate of BEVs on residential electricity consumption and carbon emissions, linked to affordability, was a system dynamics modelling process.

Using system dynamics to develop the STEVsim to address the short-term research objective to determine the daily impact of BEVs on the residential demand profile, proved unnecessary and MS Excel could easily have been used. However, the system dynamics modelling process with elements of group model building and the eight step adaptation of the current modelling practices ensured the successful development, execution and implementation of the E-StratBEV for use within the organisation through detailed system analysis and structural development with stakeholder engagements. From the



contextualisation of a mental model, which started as an idea, and the development of a proposal framework to a detailed system architecture map and causal loop diagram, the modelling process resulted in clear research direction and a defined system boundary. Although the modelling method provided some quantitative insights into regional variations of the relative impact of BEV market penetration in South Africa, it still provides more value if used for exploratory modelling and descriptive comparative scenario analysis as opposed to predictive system behaviour down to the last decimal place.

### **7.2.2 Scenario and Sensitivity Analysis**

The E-StratBEV showed that doubling the GDP (from 2% in 2019 to 4% until 2050) resulted in a 1.1% increase in residential demand, while an improvement to attain the targeted Gini coefficient in the National Development Plan (0.68 to 0.59) resulted in a 5.4% increase in residential consumption. The larger impact of an improved income distribution as opposed to economic growth on residential electricity consumption is an important consideration for long-term energy planners, in anticipation of energy futures aligned with evolving business models.

Average car ownership is more than double in Gauteng compared to the rest of the provinces. The use of passenger vehicles for work commuting is significantly higher in the Gauteng and the Western Cape provinces with the average car ownership more than double in Gauteng compared to the rest of the provinces. Gauteng province has the highest difference between Actual and Affordable ICEVs by 2050 (4.252 million), followed by the Western Cape province (1.545 million) and KwaZulu Natal province (1.174 million). All the other provinces have smaller gaps between the Actual and Affordable ICEVs (ranging from 0.108 million to 0.519 million). Although the wealthy income groups will purchase luxury vehicles irrespective of the economic drivers in the country, the middle income groups may be influenced by vehicle financing schemes such as balloon payments, or consumer lifestyle aspirations and upscale spending, which would account for the high gaps between Actual and Affordable ICEVs reflecting the results which show that consumers live far beyond their financial means and affordability in South Africa. While this may be intuitive, the calculations to determine the gap resulted in an ICEV correction factor and a BEV adjustment factor which was used to quantify the additional number of BEVs expected due to drivers such as the purchase price, charging infrastructure, range anxiety and reputation effect.

For this study, the Low Growth BEV scenario, using the GDP parametric of 0.0057 (South Africa's GDP fraction of the world's GDP) and a national BEV forecast of 41 million by 2040,

indicated a BEV target of 233,700 by 2040 for South Africa. The High Growth scenario was 2.39 million BEVs by 2040 based on South Africa's pledge to support the Paris Agreement on Climate Change commitments in April 2016. Through the modelling process it was established that GDP would be used to determine the provincial distributions of BEVs since the GDP has been linked to an increase in the purchase of luxury goods and BEVs are currently considered as luxury items. With BEV drivers and incentives requiring extensive time for government, private and public sector negotiations, it was assumed that BEVs would remain a luxury item for the simulation timeframe. However, once purchase parity is reached, the disposable income should be used to determine the provincial BEV distributions, adjusted by the ICEV correction factor.

The BEV growth drivers introduced an additional 1,589 BEVs to the Low Growth scenario and an additional 16,257 BEVs to the High Growth targets from 2019 to 2040. Results from the E-StratBEV showed that the decrease in BEV purchase price resulted in an additional 944 BEVs for the Low Growth scenario run and an additional 9,658 BEVs for the High Growth scenario run while the impact of increasing charging stations and improving range anxiety was comparable and not as significant. A consumer's risk tolerance for new technology is influenced by public attitudes and preferences, but the reputation effect driver, showed the least sensitive impact with an additional 1,173 BEVs for the High Growth scenario.

The national electricity consumption of charging the BEVs results in an increase of ~14.46% in residential electricity consumption by 2040 if the High Growth scenario is achieved and negligible impacts for the Low Growth scenario. For the Low Growth scenario, BEV drivers add a further cumulative total of 270 GWh from 2019 until 2040 while the High Growth BEV drivers add a further 2,764 GWh to the residential consumption. Gauteng province had the highest impact on residential consumption from 2019 until 2040 (adding an additional cumulative 43,898 GWh for the High Growth scenario or cumulative 4,291 GWh with the Low Growth scenario), followed by KwaZulu Natal province (adding an additional 20,140 GWh for the High Growth scenario or 1,969 GWh with the Low Growth), then the Western Cape (adding an additional 17,435 GWh for the High Growth scenario or 1,704 GWh with the Low Growth).

For a coal heavy supply mix, the cumulative carbon emissions from 2019 until 2040, for the Low Growth scenario results in an increase of 10.04 Mton in the energy sector and a 8.21 decrease in the transport sector; while for a renewables heavy supply mix, the cumulative carbon emissions for the Low Growth scenario results in an increase of 7.8 Mton in the

energy sector. The High Growth scenario results in 102.86 Mton cumulative carbon emissions in the energy sector for a coal heavy supply mix and 79.16 Mton for a renewables heavy supply mix, compared to a decrease of 84.98 Mton in the transport sector. The net decrease in CO<sub>2</sub> emissions in the transport sector due to substitution with BEVs would benefit the country if the future supply mix was largely renewable in nature as opposed to if it was coal heavy. However, the renewables heavy supply mix does not consider the weighted average cost of electricity with the supply mix or technology costs or grid integration impacts and although it appears a better choice, all factors have to be considered in changing the electricity supply mix.

To effect changes to the current predominantly coal generating supply mix in South Africa, without disrupting economic activity, may require extensive long-term financial investments and technical and resource planning, short-term options such as solar powered charging stations would be required to charge the BEVs. Additionally, other initiatives would be required to reduce national carbon emissions such as energy efficient drives, environmentally friendly and fuel efficient aircraft and more fuel efficient ICEVs. On a provincial level, the Western Cape province appears to benefit the most with a higher reduction of carbon emissions in the transport sector even with a coal heavy supply mix (a small net increase of 1.31 Mton in the energy sector compared to the 1.42 Mton decrease in the transport sector).

The top quintile in South Africa earns 40 times more than the lowest quintile; with the highest income decile 10 is dominated by Gauteng (40%) while KwaZulu Natal and the Western Cape make up another 43% of that income group. If BEVs purchases align with the current practices within deciles on expenditure on transport and vehicle expenditure then the expected BEV distributions per province will be significantly lower than the expected targets. This means that nationally, although the Low Growth scenario indicates about 233,700 BEVs by 2040, the adjusted number (based on the spending behaviour within deciles) may result in 44,155 BEVs. The High Growth scenario has an expected 2,389,950 BEVs by 2040 but the adjusted number may well be 451,736 BEVs.

### **7.3 Validation of Contributions**

Historical empirical data was available for electricity, energy, ICEVs (Stats SA, 2016), GDP (Stats SA, 2018), disposable income (Van Heerden, 2016), population and households (Stats SA, 2017), economic sector energy intensities and BEV sales (Knight & Thompson, 2018); and the simulated results could be compared to the actual historical trends. The

future trends had to be derived through theoretical and mathematical means, which were tested against literature and other forecasts e.g. the endogenously calculated carbon emissions in the energy and transport sector due to BEV substitutions of ICEVs was compared against the CSIR 2030 regional BEV forecasts (Bischof-Niemz, et al., 2017), and improvements in vehicle efficiency used the ERC's Vehicle-parc model (Merven B. , Stone, Hughes, & Cohen, 2012).

Some variables such as the quantitative weighted contribution of BEV drivers to the initial expected market penetration of BEVs had to be established through expert opinion (Snyman, 2017; Brown, 2016) and extensive multiple engagements with the eMobility team at Eskom (some members have been involved with early EV pilot projects as far back as 1988), and aligned with results from studies in other countries (Reichmuth & Goldman, 2017) (Yilmaz & Krein, 2013). Besides several engagements within the organisation, in terms of expert opinion validation, engagements were held with Hiten Parmar, the Director of the uYilo e-Mobility Programme, whereby the simulator was demonstrated and assumptions on variables such as percent charging at home, driver impact sensitivity, EV targets, and affordability was discussed and confirmed, based on his experience. Watson Collins from the Electric Power Research Institute (preparing a report on eMobility for the organisation) was also engaged with on assumptions and the structure of the model as well as results. Further calibration of variables such as the consumer behaviour to purchase more BEVs as the cost parity with ICEVs is reached, can be continued through experience and as data becomes available through more BEV pilot studies in South Africa.

Extensive time was spent for this study on preliminary analysis including statistical method and programmable code to determine possible relationships of variables which could be causally and structurally linked in the model. The empirical gaps in historical data were completed through classical regression and numerical interpolation. Future trends dismissed perpetual linear growth on the premise that trends tend to plateau and should reflect the carrying capacity of a system which is has biophysical constraints. Due to the detailed preliminary analysis and calculations, it was easier to establish if any integration errors or errors due to incorrect structural linkages were made once the model was developed. After the preliminary analysis and throughout the development of the sub-modules, validation of the model outputs was carried out by engagements and work group meetings with various subject matter experts where scenarios were run and the model initialisation and parameters were further calibrated according to experience and new information which emerged, a process which allowed for theoretical and empirical consistency checks.

## 7.4 Limitations of the Study

Although this study forecasts the annual provincial BEV sales which would be required from 2019 until 2040 and its expected impact on residential electricity consumption and carbon emissions, the complex nature of the system problem introduces various levels of uncertainty which will inevitably affect the long-term forecast such as:

- Political influence and government actions to effect import taxes, incentivise local manufacturers and support infrastructural development in a cost effective manner,
- The date of BEV penetration starts from 2019 but this could even shift by 5-10 years depending on when consumers are incentivised and when policies to support BEVs are implemented, thus the forecasts will be affected,

The study has also been limited by virtue of exclusions, which was not part of the initial scope, but which will provide better resolution of results such as EVs in larger fleets, such as public transport busses and company transport, and the impact on electricity consumption and carbon emissions on a larger-scale. Calculating the impact of trucks, buses, minibus taxis (MBTs) and light duty vehicles (LDVs) on carbon emissions in the transport industry and then the perceived benefits by substitution with their electric counterparts will impact many business models relying on electric passenger vehicles as green technology options for climate change mitigation or to generate electricity sales revenues.

In South Africa, deciles 1-3 rely on public transport (buses/ trains/minibus taxis). If buses become electric like the Chinese built state-of-the-art electric buses which can be flash charged in 30 seconds using supercapacitors and travel 6 km on that charge, this will affect urban carbon emissions and electricity consumption (ES Components, 2017). Calculations will have to be completed for the transport sector and the net impact to the environment for various vehicle categories when supplied with electrical energy from a coal heavy generating mix.

Further work will be required on sources for charging electric buses and electric trucks, besides electric passenger vehicles. Although cities like Vancouver have plans to cut emissions by 80% through substitution of the entire fuel combusted fleet with the electric versions, their options to charge will include solar PV panels and renewable natural gas (City of Vancouver, 2017). In South Africa, electricity generation options using gas reserves will have to be researched further.

For weighted average cost of electricity calculations, a renewables heavy generation mix would equate to 40% more than a coal heavy mix in 2040 but further work should be done on tariff structures and options so that low income groups are not negatively impacted. With the current economic climate challenging the present tariff hike applications in South Africa, changing the generation mix will mean an even greater impact on user tariffs which has political, social and further negative economic impacts.

The inclusion of hybrid and plug-in hybrid passenger vehicles is necessary since the EV passenger market will not be exclusive to pure electric vehicles. Plug-in hybrids have a utility factor (UF) which will impact the average electric range (AER) resulting in a fraction of the annual distances being driven electrically. For example, the Toyota Prius Plug-in has a UF of 72% which means that instead of calculating electrical charging for an annual distance of 25,915 km, the electrical distance will be 18,658 km while an annual distance of 7,256 km per vehicle will contribute towards additional carbon emissions in the transport industry.

The use of logistic S-curves to determine the long-term behaviour of variables in this study may be subject to bias due to the method relying on the accuracy of the independent variables expected to influence the behaviour of the equation in that environment. This method's inclusion of qualitative elements to determine the environmental influence could introduce errors in the long-term forecasts. A possible solution is to calibrate the model with empirical data such as BEV sales patterns and consumer behaviour per province over a long enough time period that will inform a pattern of behaviour, which could be linked to a mathematical forecast.

## **7.5 Opportunities for Future Research**

Future research could factor in the entire value chain for electric vehicles, from the raw materials and processing to the manufacturing of the discrete components, including the electric motor, transmission, batteries, electronics, capacitors, braking system, structural elements, wheels and tyres, as well as the vehicle base. This will allow for a detailed financial model to be developed to know the cost elements and identify which variable changes will add the greatest benefit for cost reduction. Besides improving battery technology, other aspects such as carbon fibre and lightweight materials could increase range and lower costs and environmental emissions and this can be further explored. Another area of research expansion could focus on making the electric vehicles a truly green technology option, thus requiring a comprehensive "well-to-wheel" emissions study.

Once the uptake of BEVs increases, it will be easier to determine the time-of-use charging behaviour of consumers in the residential sector. This will help to more accurately understand daily BEV demand impacts on the electricity load, in support of grid integration studies.

The adapted system dynamics modelling process allowed for the successful development and implementation of the E-StratBEV, however, the process can be further enhanced by establishing criteria to check project complexity and the extent of non-linearity of variables. This checklist, based on a database of projects where the adapted system dynamics modelling process has been successfully applied, will be useful in guiding a modeller to whether the approach will be applicable before commencement.

## References

- ACEA. (2017, October 10). *Interactive map: Correlation between uptake of electric cars and GDP in the EU*. European Automobile Manufacturers Association [Online] <http://www.acea.be/statistics/article/interactive-map-correlation-between-uptake-of-electric-cars-and-gdp-in-EU>. [2018, June 15].
- Ackoff, R. L., & Sasieni, M. W. (1968). *Fundamentals of Operations Research*. John Wiley & Sons Inc.
- AFRASIA. (2017). *Africa Wealth report 2017*. New World Wealth.
- Aiyer, S. (2018, March 14). *Here's How South Africa Can Become An R8.8-TRILLION Economy By 2025*. Huffington Post [Online] [https://www.huffingtonpost.co.za/sourajit-aiyer/heres-how-south-africa-can-become-an-r8-8-trillion-economy-by-2025\\_a\\_23381175/](https://www.huffingtonpost.co.za/sourajit-aiyer/heres-how-south-africa-can-become-an-r8-8-trillion-economy-by-2025_a_23381175/). [2018, June 14].
- Al-Alawi, B., & Bradley, T. (2013). *Review of Hybrid, Plug-In Hybrid, and Electric Vehicle Market Modeling Studies*. Renewable and Sustainable Energy Reviews, 190-203.
- Albin, S. (1997, June 30). *Building a System Dynamics Model Part 1: Conceptualization*. MIT System Dynamics in Education Project. Massachusetts Institute of Technology.
- Alexander, M. (2013). Media club South Africa [Online] [http://www.medioclubsouthafrica.com/landstatic/163-provinces\\_new](http://www.medioclubsouthafrica.com/landstatic/163-provinces_new). [2016, April 4].
- Amberber, E. (2014, October 16). *South Africa's MellowCabs: when urban transportation meets advertising* [Online] <https://yourstory.com/2014/10/mellowcabs/>. [2018, January 31].
- Amusa, H., Amusa, K., & Mabuga, R. (2009, June). *Aggregate demand for electricity in South Africa: An analysis using the bounds testing approach to cointegration*. Energy Policy, 37, 4167–4175.
- Andersen, D. F., & Richardson, G. R. (1997, Summer). *Scripts for Group Model Building*. System Dynamics Review, 13(2), 107-129.
- Andrews, A. (2014, April). *Draft Policy for Promoting Sustainable (Green) Transport in Gauteng*. Department of Road & Transport, Gauteng. South Africa.
- ANA Group. (2014). *Efforts to Reduce CO<sub>2</sub> Emissions*. ANA Group [Online] <https://www.ana.co.jp/group/en/csr/environment/effort.html>. [2017, December 13].
- Apter, M. J., & Wolpert, L. (2006, March 24). *Cybernetics and development, Information theory*. Journal of Theoretical Biology, 8(2), 244-257.
- ARB. (2017, January 18). *California's Advanced Clean Cars - Midterm Review*. Air Resources Board [Online] [https://www.arb.ca.gov/msprog/acc/mtr/acc\\_mtr\\_finalreport\\_full.pdf](https://www.arb.ca.gov/msprog/acc/mtr/acc_mtr_finalreport_full.pdf). [2018, May 23].
- ArriveAlive. (2006, November). *Registered Vehicles*. ArriveAlive [Online] [https://www.arrivealive.co.za/document/Nov\\_PDFS/Nov2006\\_RegVehs\\_LicPrDP\\_Fuel\\_Dist1.pdf](https://www.arrivealive.co.za/document/Nov_PDFS/Nov2006_RegVehs_LicPrDP_Fuel_Dist1.pdf). [2017, October 10].
- ArriveAlive. (2017). *Registered Vehicles*. ArriveAlive [Online] <https://www.arrivealive.co.za/Registered-Vehicles>. [2017, October 30].
- Autotrader. (2015, November). *5 Best Electric Cars*. Autotrader [Online] <https://www.autotrader.co.za/car-news/bmw/i8/f6be0fa6-c465-417b-9e0d-9722f0bf9dc5-5-best-electric-cars>. [2017, December 4].



- Awerbuch, S. (2006). *Portfolio-Based Electricity Generation Planning: Policy Implications For Renewables And Energy Security*. *Mitigation and Adaptation Strategies for Global Change*, 11(3), 693-710.
- Bagchi, S., & Svenjnar, J. (2015). *Does wealth inequality matter for growth? The effect of billionaire wealth, income distribution, and poverty*. *Journal of Comparative Economics*, 43(3), 505-530.
- Baianu, I. C. (2011, November). *Complexity, Emergent Systems, Life and Complex Biological Systems: Complex Systems Theory and Biodynamics*. Eprints, University of Southampton.
- Bairamzadeh, S., Saidi-Mehrabad, M., & Pishvae, M. S. (2018, February). *Modelling different types of uncertainty in biofuel supply network design and planning: A robust optimization approach*. *Renewable Energy*, 116(Part A), 500-517.
- Baker, L., & Phillips, J. (2018, June). *Tensions in the transition: the politics of electricity distribution in South Africa*. *Environment and Planning C: Politics and Space*.
- Bankes, S. (1993, May-June). *Exploratory Modelling for Policy Analysis*. *Operations Research*, 41(3), 435-449.
- Barlas, Y. (1996). *Formal aspects of model validity and validation in system dynamics*. *System Dynamics Review*, 12(3), 183-210.
- Barnes, J., & Black, A. (2003). *Motor Industry Development Programme: Review Report*. Department of Trade and Industry, South Africa.
- Barnett, M. W. (2003). *Modeling & Simulation In Business Process Management*. Gensym Corporation [Online] <https://www.bptrends.com/publicationfiles/11-03%20WP%20Mod%20Simulation%20of%20BPM%20-%20Barnett-1.pdf>. [2017, June 20].
- Barranquero, J., Chica, M., Cordon, O., & Damas, S. (2015). *Detecting Key Variables in System Dynamics Modelling by Using Social Network Metrics*. Switzerland: Springer International.
- Batteries. (2016). *Recharge: The European Association for Advanced Rechargeable Batteries* [Online] <http://www.rechargebatteries.org/knowledge-base/batteries/lithium-ion-cell-lilon/>. [2016, June 6].
- Battery University. (2016, May 13). *Learn about Batteries*. Battery University [Online] [http://batteryuniversity.com/learn/article/types\\_of\\_lithium\\_ion](http://batteryuniversity.com/learn/article/types_of_lithium_ion) [2016, June 14].
- Baudry, G., Macharis, C., & Vallee, T. (2018, January 1). *Range-based Multi-Actor Multi-Criteria Analysis: A combined method of Multi-Actor Multi-Criteria Analysis and Monte Carlo simulation to support participatory decision making under uncertainty*. *European Journal of Operational Research*, 264(1), 257-269.
- BCG. (2010). *Batteries for Electric Cars: Challenges, Opportunities and the Outlook to 2020*. Focus. The Boston Consulting Group.
- Beeton, D. (2015, October 28). *The Future of Electric Mobility: Today, Tomorrow...and in Dundee*. Urban Foresight.
- Bellis, M. (2016). *History of Electric Vehicles*. About.com [Online] <http://inventors.about.com/od/cstartinventions/a/History-Of-Electric-Vehicles.htm>. [2016, June 10].
- Benson, R. A. (1970, August ). *Gini Ratios: Some considerations affecting their interpretation*. *American Journal of Agricultural Economics*, 52(3), 444-447.

- Bento, A., Roth, K., & Zuo, Y. (2016, January 18). *Vehicle Lifetime Trends and Scrappage Behaviour in the U.S. Used Car Market*. University of California [Online] [http://faculty.sites.uci.edu/kevinroth/files/2011/03/Scrappage\\_18Jan2016.pdf](http://faculty.sites.uci.edu/kevinroth/files/2011/03/Scrappage_18Jan2016.pdf). [2018, June 6].
- Berckmans, G., Messagie, M., Smekens, J., Omar, N., Vanhaverbeke, L., & Van Mierlo, J. (2017, September). *Cost Projection of State of the Art Lithium-Ion Batteries for Electric Vehicles Up to 2030*. *Energy Research, Engineering and Policy Journal*, 10(9), 1314.
- Bergek, A., Berggren, C., Magnusson, T., & Hobday, M. (2013, July-August). *Technological discontinuities and the challenge for incumbent firms: Destruction, disruption or creative accumulation?* *Research Policy*, 42(6-7), 1210-1224.
- Bessenbach, N., & Wallrapp, S. (2013). *Why do Consumers resist buying Electric Vehicles. An empirical Study of Innovation Perception and the Effect of Consumer Characteristics, Innovation Exposure and Buying Incentives*. Copenhagen Business School.
- Bhana, A. (2017, August). *SA shaky on supporting electric vehicle rollout*. Moneyweb [Online] <https://www.moneyweb.co.za/in-depth/sa-shaky-on-supporting-electric-vehicle-rollout/>. [2017, November 11].
- Bialek, R., Duffy, G., & Moran, J. (2009). *Spaghetti Diagram*. In *The Public Health Quality Improvement Handbook* (p. 220). Milwaukee: ASQ Quality Press.
- Billbeisi, K., & Kesse, M. (2017, April). *Tesla: A Successful Entrepreneurship Strategy*. Clayton State University.
- Biloslavo, R., Bagnoli, C., & Edgar, D. (2018, February 10). *An eco-critical perspective on business models: The value triangle as an approach to closing the sustainability gap*. *Journal of Cleaner Production*, 174, 746-762.
- Bischof-Niemz, T., Calitz, J., Tazvinga, H., Fourie, R., Mushwana, C., Nkosi, M., et al. (2017). *The impact of a significantly increased electric vehicle fleet on South Africa's 2016 Integrated Resource Plan*. CSIR. Pretoria: CSIR.
- Black, A., & Mitchell, S. (2005, July 6). *Policy in the South African Motor Industry: Goals, Incentives and Outcomes*. *South African Journal of Economics*, 70(8), 1273-1279.
- Bloch, M. (2012, October 19). *Estimating your cars carbon dioxide emission impact*. Green Living Tips [Online] <https://www.greenlivingtips.com/articles/calculating-car-carbon-emissions.html>. [2016, June 10].
- Blog: 21 February 2017 (Number of vehicles registered per province as per end January 2017)*. South African Market [Online] <https://www.southafricanmi.com/blog-21feb2017.html>. [2017, December 18].
- Board of Governors of the Federal Reserve System. (2011, April). *Supervisory Guidance on Model Risk Management*. Office of the Comptroller of the Currency [Online] <https://www.occ.treas.gov/news-issuances/bulletins/2011/bulletin-2011-12a.pdf>. [2018, June 3].
- Bohatch, T. (2017, May). *What's Causing Cape Towns Water Crisis*. GroundUp [Online] <https://www.groundup.org.za/article/whats-causing-cape-towns-water-crisis/>. [2017, December 14].

- Bonges III, H. A., & Lusk, A. C. (2016, January). *Addressing electric vehicle (EV) sales and range anxiety through parking layout, policy and regulation*. Transportation Research Part A: Policy and Practice, 83, 36-73.
- Booyens, D. (2014). *Long-Term Role Of Coal In The Generation Supply Mix*. Johannesburg: Eskom.
- Booyens, D., & Pillay, N. S. (2016). *Long Term Role of Coal in the Generation Supply Mix*. 34th International System Dynamics Conference. Boston: System Dynamics Society.
- Bosch, A., Rossouw, J., Claassens, T., & Du Plessis, B. (2010, September). *A Second look at measuring inequality in South Africa: A modified Gini coefficient*.
- Botes, E. (2014, December 15). *Note on the benchmark revisions and rebasing of South Africa's national accounts statistics*. Reserve Bank [Online] <https://www.resbank.co.za/Lists/News%20and%20Publications/Attachments/6534/05Note%20on%20the%20benchmark%20revisions%20and%20rebasng%20of%20South%20Africa%27s%20national%20accounts%20statistics.pdf>. [2018, March 5].
- Brennan, J. W., & Barder, T. E. (2016, November 29). *Battery Electric Vehicles vs. Internal Combustion Engine Vehicles*. Arthur D Little [Online] [http://www.adlittle.de/sites/default/files/viewpoints/ADL\\_BEVs\\_vs\\_ICEVs\\_FINAL\\_November\\_292016.pdf](http://www.adlittle.de/sites/default/files/viewpoints/ADL_BEVs_vs_ICEVs_FINAL_November_292016.pdf). [2018, May 23].
- Brent, A. C. (2018). *System dynamics models for Africa's developmental planning*. (T. Simelane, Ed.) Pretoria, South Africa: Human Sciences Research Council, and the Africa Institute of South Africa.
- Brent, A. C., Musango, J. K., Smit, S., Pillay, N. S., Botha, A., Louw, R., et al. (2016, May). *Utilization of System Dynamics in Southern Africa: A Systematic Review*. Systems Research & Behavioural Science, 34(6), 657-60.
- Brouwer, A. S., Kuramochi, T., Van Den Broek, M., & Faaij, A. (2013, July). *Fulfilling the electricity demand of electric vehicles in the long term future: An evaluation of centralized and decentralized power supply systems*. Applied Energy, 107, 33-51.
- Brouwer, F., Avgerinopoulos, G., Fazekas, D., Laspidou, C., Mercure, J.-F., Pollit, H., et al. (2018, January). *Energy modelling and the Nexus concept*. Energy Strategy Reviews, 19, 1-6.
- Brown, J. (2016, December). *SA to see more electric vehicles*. Fin24 [Online] <https://www.fin24.com/Tech/News/sa-to-see-more-electric-vehicles-20161209>. [2017, December 11].
- Brown, J. (2016, December 11). *SA to see more electric vehicles*. Fin24Tech [Online] <http://www.fin24.com/Tech/News/sa-to-see-more-electric-vehicles-20161209>. [2017, February 10].
- Bubear, R. (2017, January 23). *Here are ALL the cars the government bought in 2016*. CarMag [Online] <http://www.carmag.co.za/news/industry-news/here-are-all-the-cars-the-government-bought-in-2016/>. [2018, May 23].
- Buchmann, I. (2017, December 15). *Discover alternatives to fossil fuel in batteries*. Battery University [Online] [http://batteryuniversity.com/learn/article/electric\\_vehicle\\_ev](http://batteryuniversity.com/learn/article/electric_vehicle_ev). [2018, February 1].
- Budget Review 2016*. (2016, February). South Africa: National Treasury.
- Budzik, P. M., & Naill, R. F. (1976). *FOSSIL 1: A policy analysis model of the U.S. energy transition*. WSC '76 Proceedings of the 76 Bicentennial conference on Winter simulation , (pp. 145-152).

- Bureau of Market Research. (2007, May). *Population and household predictions for South Africa by province and population group 2001-2021*. Bureau of Market Research [Online] <http://www.foresightfordevelopment.org/sobipro/download-file/46-662/54>. [2017, May 21].
- Capeetc. (2015, May 27). *Cape Town Set To Be South Africa's First Electric Car Charging Hub*. Cape Town etc [Online] [https://www.google.com/search?q=EV+Charging+infrastructure+city+of+cape+town&source=lnms&tbn=isch&sa=X&ved=0ahUKEwjt2Ijx3YHZAhUCasAKHUnjCaUQ\\_AUICigB&biw=960&bih=479#imgrc=\\_JcjrpcHFkNffM](https://www.google.com/search?q=EV+Charging+infrastructure+city+of+cape+town&source=lnms&tbn=isch&sa=X&ved=0ahUKEwjt2Ijx3YHZAhUCasAKHUnjCaUQ_AUICigB&biw=960&bih=479#imgrc=_JcjrpcHFkNffM). [2018, January 3].
- Car History. (2009). *Electric Vehicles Recent Years (1990 to 1998)*. Car History: Become smart with car history [Online] <http://carhistory-plate.blogspot.co.za/2009/01/electric-vehicles-recent-years-1990-to.html>. [2016, June 12].
- Carravilla, M. A., & Oliveira, J. F. (2018). *Resources for the Education in Operations Research: Past, Present and Future*. (J. Beliën, A. Teixeira, H. W. Ittmann, J. de Miranda, M. Laumanns, & M. Vaz Pato, Eds.) Cham: Springer International Publishing.
- Carter, M. (2014, March 02). *Electric Cars, Green Transportation*. Inhabitat [Online] <https://inhabitat.com/teslas-lithium-ion-battery-gigafactory-to-reduce-battery-costs-by-more-than-30/>. [2017, December 4].
- Caserta, K. (2008). *Luxury Good Demand*. Boston College. Boston College.
- Cavana, R. Y., & Maani, K. E. (2000). *A Methodological Framework for Integrating Systems Thinking and System Dynamics*. 18<sup>th</sup> International Conference of the System Dynamics Society.
- Centre for Advanced Energy Studies. (1997, December). *Advanced Vehicle Testing Activity*. Idaho National Laboratory.
- Chamon, M., Mauro, P., & Okawa, Y. (2008, April). *Mass car ownership in the emerging market giants*. *Economic Policy*, 23(54), 244-296.
- Chan, C. C. (2013, January). *The Rise & Fall Of Electric Vehicles In 1828–1930: Lessons Learned*. *Proceedings of the IEEE*, 101(1), 206-212.
- Chan, C. C., Wong, Y. S., Bouscayrol, A., & Chen, K. (2009, April). *Powering Sustainable Mobility: Roadmaps of Electric, Hybrid, and Fuel Cell Vehicles*. *Proceedings of the IEEE*, 97, 4, 603-607.
- Chapman, D. (2018, January 30). *Eskom eMobility Programme*. Johannesburg, South Africa.
- Chen, M., Zhang, H., Liu, W., & Zhang, W. (2014, August). *The Global Pattern of Urbanization and Economic Growth: Evidence from the Last Three Decades*. *PLoS One*, 9(8).
- Cheng, Y.-H., & Chang, Y.-H. (2015, November 1). *Urban transportation energy and carbon dioxide emission reduction strategies*. *Applied Energy*, 157, 953-973.
- Cheron, E., & Zins, M. (1997). *Electric Vehicle Purchasing Intentions: the concern over battery charge duration*. *Transportation Research Part A: Policy and Practice*, 31(3), 235-243.
- Chettiar, M., Lakmeharan, K., & Koch, R. (2009). *A Review of the January 2008 Electricity Crisis in South Africa: A Problem a Decade in the Making*. Sixth Southern Africa Regional Conference. Paris: Cigre.
- Cheyne, C., & Imran, M. (2016, August). *Shared transport: Reducing energy demand and enhancing transport options for residents of small towns*. *Energy Research & Social Science*, 18, 139-150.

- Chinembiri, E. K. (2010, January). *An Empirical Assessment of the Impact of Trade Liberalization on Employment in South Africa*. A paper for Trade and Industrial Policy Studies. TIPS.
- Christ, C. F. (1967, March). *Econometrics and Model-Building*. The ANNALS of the American Academy of Political and Social Science, 370(1), 164-175.
- Chung, D., Elgqvist, E., & Santhanagopalan, S. (2016). *Automotive Lithium-ion Cell Manufacturing: Regional Cost Structures and Supply Chain Considerations*. Technical Report NREL/TP-6A20-66086, Clean Energy Manufacturing Analysis Center.
- Cinlar, E. (1975). *Introduction to Stochastic Processes*. Prentice-Hall International.
- City of Vancouver (2017, October 24). *Renewable City Strategy Update*. [Online] <https://council.vancouver.ca/20171101/documents/pspc1.pdf>
- Clarke, R. G. (1995). *More evidence on income distribution and growth*. Journal of Development Economics, 47(2), 403-427.
- Clarkson, G. (1963). *The theme of consumer demand: a critical appraisal*. Prentice-Hall.
- Clarkson, G. (1964, February). *The Theory of Consumer Demand: A Critical Appraisal*. Journal of Political Economy, 72(1), 98-99.
- Coffman, M., Bernstein, P., & Wee, S. (2015, April). *Factors Affecting EV Adoption: A Literature Review and EV Forecast for Hawaii*. Florida: University of Central Florida.
- Coffman, M., Bernstein, P., & Wee, S. (2016, August 10). *Electric vehicles revisited: a review of factors that affect adoption*. Transport Reviews, 37(1), 79-93.
- Cokayne, R. (2018, May 2). *Government urged to switch on and aid SA electric vehicle market*. IOL [Online] <https://www.iol.co.za/business-report/technology/government-urged-to-switch-on-and-aid-sa-electric-vehicle-market-14737799>. [2018, June 18].
- Collins. (2018). *Definition of Disposable Income*. Collins English Dictionary [Online] <https://www.collinsdictionary.com/dictionary/english/disposable-income>. [2018, March 27].
- Cover, T. M., & Thomas, J. A. (2016). *Elements of Information Theory Second Edition*. Hoboken, New Jersey: John Wiley & Sons Inc.
- Coyle, R. G. (1996). *System Dynamics Modelling: A practical approach* (Vol. 1). Florida, USA: Chapman & Hall/CRC.
- Creamer, T. (2018, April 2018). *Extreme inequality in South Africa is constraining growth and investment*. Engineering News [Online] [http://www.engineeringnews.co.za/article/extreme-inequality-is-constraining-south-african-investment-and-growth-2018-04-10/rep\\_id:4136](http://www.engineeringnews.co.za/article/extreme-inequality-is-constraining-south-african-investment-and-growth-2018-04-10/rep_id:4136). [2018, May 25].
- Cronin, M. A., Gonzalez, C., & Sterman, J. D. (2009). *Why don't well-educated adults understand accumulation? A challenge to researchers, educators, and citizens*. Organizational behavior and Human decision Processes, 116-130.
- CSIR. (2016, January). *Forecasts for electricity demand in South Africa (2014 – 2050) using the CSIR sectoral regression model*. Department of Energy [Online] <http://www.energy.gov.za/IRP/2016/IRP-AnnexureB-Demand-forecasts-report.pdf>. [2018, May 17].
- Curry, C. (2017, July 5). *Lithium-ion Battery Costs and Market*. Bloomberg New Energy Finance. Bloomberg.

- Curtin, R., Shrago, Y., & Mikkelsen, J. (2009). *Plug-in Hybrid Electric Vehicles*. University of Michigan. Michigan.
- Curtin, S., & Gangi, J. (2016). *Fuel Cell Technologies Market Report 2016*. U.S. Department of Energy [Online] [https://www.energy.gov/sites/prod/files/2017/10/f37/fcto\\_2016\\_market\\_report.pdf](https://www.energy.gov/sites/prod/files/2017/10/f37/fcto_2016_market_report.pdf). [2018, May 22].
- Dane, A. (2013). *The potential of electric vehicles to contribute to South Africa's greenhouse gas emissions targets and other developmental objectives*. Cape Town, South Africa: Energy Research Centre, University of Cape Town.
- Dane, A. (2017, December 4). *South African Electric Vehicle Macro-economic Study: EVIA Conference*. Change Pathways [Online] [http://www.evia.org.za/AnthonyDane\\_ChangePathways\\_SAEVmacro\\_economicstudy\\_v2.pdf](http://www.evia.org.za/AnthonyDane_ChangePathways_SAEVmacro_economicstudy_v2.pdf). [2018, May 23].
- Danneels, E. (2004). *Disruptive Technology Reconsidered: A Critique and Research Agenda*. The Journal of Product Innovation Management, 21(4), 246-248.
- Darby, S. J. (2018, January). *Smart electric storage heating and potential for residential demand response*. Energy Efficiency, 11(1), 67-77.
- Dargay, J., & Gately, D. (1997). *Vehicle Ownership to 2015: implications for energy use and emissions*. Energy Policy, 25(14-15), 1121-1127.
- Dargay, J., & Gately, D. (2001). *Modelling Global Vehicle Ownership*. In C.-H. Park, J. R. Cho, J. Oh, Y. Hayashi, & J. Viegas (Ed.), *Proceedings of the 9th World Conference on Transport Research* (pp. 22-27). Seoul: Pergamon.
- Dargay, J., & Gately, D. (1999, February). *Income's effect on car and vehicle ownership, worldwide: 1960–2015*. Transportation Research Part A: Policy and Practice, 33(2), 101-138.
- De Greene, K. B. (1993). *A Systems-Based Approach to Policymaking*. New York: Springer Science Business Media.
- De Maio, F. G. (2007, October). *Income Inequality Measures*. Journal of Epidemiology & Community Health, 61(10), 849-852.
- DEA. (2010). *National Climate Change Response Green Paper 2010*. Government Gazette, South African Government.
- DEA. (2011, October). *National Climate Change Response White Paper*. South African Government [Online] [https://www.gov.za/sites/www.gov.za/files/national\\_climatechange\\_response\\_whitepaper\\_0.pdf](https://www.gov.za/sites/www.gov.za/files/national_climatechange_response_whitepaper_0.pdf). [2018, May 17].
- DEA. (2014, November). *GHG National Inventory Report for South Africa: 2000-2010*. South Africa: Department of Environmental Affairs.
- DEA. (2016, November). *South Africa joins Nations of the World in ratifying the Paris Agreement on Climate Change*. Department of Environmental Affairs [Online] [https://www.environment.gov.za/mediarelease/southafrica\\_ratifies\\_parisagreement](https://www.environment.gov.za/mediarelease/southafrica_ratifies_parisagreement). [2018, May 23].



- DEAT Scenario Building Team. (2007). *Long Term Mitigation Scenarios - Strategic Options for South Africa*. Department of Environment Affairs and Tourism. Pretoria.
- Del Duce, A., Egede, P., Öhlschläger, G., Dettmer, T., Althaus, H., Butler, T., et al. (2013). *Guidelines for the LCA of electric vehicles*. eLCAR.
- Deloitte. (2017, February). *An overview of electricity consumption and pricing in South Africa. An analysis of the historical trends and policies, key issues and outlook in 2017*. Eskom [Online] <http://www.eskom.co.za/Documents/EcoOverviewElectricitySA-2017.pdf>. [2018, May 17].
- Demirođlu, U., & Yüncüle, C. (2016). *Estimating Light-Vehicle Sales in Turkey*. Central Bank Review(3), 16, 93-108. Turkey: Research and Monetary Policy Department.
- Djotaroeno, D. S. (2010). *Application of Hubbert Peak Oil Theory to Model Life Cycle Cost of Oil Assets in Suriname*. Maastricht School of Management (MSM). MSM.
- DMR. (2011, July). *The Beneficiation Startegy for the Minerals Industry of South Africa*. Department of Mineral Resources [Online] <http://www.google.com/url?sa=t&rct=j&q=&esrc=s&source=web&cd=1&cad=rja&uact=8&ved=0ahUKEwjKorX6sozbAhWGa8AKHfnrDGsQFggmMAA&url=http%3A%2F%2Fpmg.org.za%2Ffiles%2Fdocs%2F110726dmr.ppt&usq=AOvVaw3ipXP4xBZ-v7yXW9XkBEPK>. [2018, May 17].
- DOE. (2012, October 12). *A Survey of Energy-related Behaviour and Perceptions in South Africa: The Residential Sector 2012*. Department of Energy [Online] <http://www.energy.gov.za/files/media/Pub/Survey%20of%20Energy%20related%20behaviour%20and%20perception%20in%20SA%20-%20Residential%20Sector%20-%202012.pdf>. [2018, February 27].
- DOE. (2013, June). *Draft 2012 Integrated Energy Planning Report*. Department of Energy [Online] <http://www.energy.gov.za/files/policies/energyPlanning/Draft-2012-Integrated-Energy-Planning-Report-an-Executive-Summary.pdf>. [2018, May 17].
- DOE. (2016, November 22). *Integrated Energy Plan (IEP)*. Department of Energy [Online] <http://www.energy.gov.za/files/IEP/presentations/Integrated-Energy-Plan-22-Nov-2016.pdf>. [2018, January 19].
- Doke, L. (2015, July 17). *Investment still needed in transport infrastructure*. Mail & Guardian [Online] <https://mg.co.za/article/2015-07-17-investment-still-needed-in-transport-infrastructure>. [2018, February 9].
- DOL. (2012). *Commission for Employment Equity Annual Report 2011-2012*. Department of Labour. Pretoria.
- DOT. (2004, September). *Age of Vehicle*. Arrive Alive [Online] <https://www.arrivealive.co.za/document/04AgeofVehicle.pdf>. [2017, November 11].
- DOT. (2005, August). *Key Results of the National Household Travel Survey*. Arrive alive: <https://www.arrivealive.co.za/document/household.pdf>. [2017, December 15].
- DOT. (2013, July). *Electric Vehicle Industry Road Map Key Action Plans Annexure 1*. CiteSeer [Online] <http://citeseerx.ist.psu.edu/viewdoc/download;jsessionid=06944BBE4EA90C9111EC2CD7A7E4EC8B?doi=10.1.1.360.7143&rep=rep1&type=pdf>. [2018, May 23].

- DOT. (2016, August). *Draft Green Transport Strategy: (2017-2050)*. Chemical & Allied Industries Association [Online] <https://www.caia.co.za/wp-content/uploads/2016/08/Draft%20GTS%20Revised%20v5.pdf>. [2018, January 17].
- DOT. (2016, October). *National Transport Master Plan (NATMAP) 2050 Synopsis Report*. Department of Transport [Online] <http://www.transport.gov.za/web/departement-of-transport/natmap-2050>. [2018, May 17].
- Doucette, R. T., & McCulloch, M. D. (2011, February). *Modeling the CO<sub>2</sub> emissions from battery electric vehicles given the power generation mixes of different countries*. *Energy Policy*, 39(2), 803-811.
- DTI. (2012). *South African Automotive Industry Report 2012*. The Department of Trade and Industry [Online] <http://www.thedti.gov.za/DownloadFileAction?id=763>. [2018, May 21].
- DTI. (2012). *South African Electrical Vehicle Industry Roadmap*. Department of Trade and Industry. South Africa.
- Du Plooy, C. J. (2016). *Unpredictability of Demineralized Water Production due to the Random Nature of Key Simulator Variables*. 34<sup>th</sup> International System Dynamics Conference. System Dynamics Society.
- Du Plooy, C., & Pillay, N. S. (2015). *Demineralised Water Production Planning*. 33<sup>rd</sup> International System Dynamics Conference. System Dynamics Society. Boston.
- Duke, M., Andrews, D., & Anderson, T. (2009, September). *The feasibility of long range battery electric cars in New Zealand*. *Energy Policy*, 3455-3462.
- DWA. (2017). *National Water Services Knowledge System*. Department of Water and Sanitation [Online] <http://www.dwa.gov.za/wsks/DefaultList.aspx?SubjectAreaID=1&DataTopicDetailID=69&DisplayTypeID=1&PerspectiveID=0&LvIID=10&DataTopicID=1>. [2017, October 11].
- Dykes, K. (2010, November 23). *System Dynamics and Sustainable Energy*. MIT Engineering Systems Division, MIT.
- Dyner, I., & Larsen, E. R. (2001, November). *From planning to strategy in the electricity industry*. *Energy Policy*, 29(13), 1145-1154.
- Eckart, J. (2017, November 28). *Batteries can be part of the fight against climate change - if we do these five things*. World Economic Forum [Online] <https://www.weforum.org/agenda/2017/11/battery-batteries-electric-cars-carbon-sustainable-power-energy/>. [2018, June 11].
- Egbue, O., & Long, S. (2012, September). *Barriers to widespread adoption of electric vehicles: An analysis of consumer attitudes and perceptions*. *Energy Policy*, 48, 717-729.
- Elcar*. (n.d.). Retrieved from Hemming's Motor News: <http://www.hemmings.com/index.cfm/fuseaction/articles.obg/id/30>.
- Electric Vehicle News. (1998). *Electric Vehicles History Part V*. Electric vehicles news [Online] <http://www.electricvehiclesnews.com/History/historyV.htm>. [2016, June 6].
- Electric Vehicle News. (2010, August). *Electric Vehicle Definition*. Electric Vehicle News [Online] <http://electricvehiclesnews.com/Definition/description.htm>. [2018, February 2].



- Element Energy Limited. (2013, December). *Pathways to high penetration of electric vehicles*. Cambridge.
- Eliseev, A. (2012, April 20). *Lights go off on SA electric car project*. Daily Maverick [Online] <https://www.dailymaverick.co.za/article/2012-04-20-lights-go-off-on-sa-electric-car-project/#.WwO6wHziJEY>. [2018, May 22].
- eNatis. (2018, April). *Vehicle Registrations Statistics*. eNatis [Online] <http://www.enatis.com/index.php/statistics>. [2018, May 27].
- Energy, U. D. (1993). *Overview of the ideas model - A Dynamic Long-Term Policy Simulation Model of U.S. Energy Supply and Demand*.
- EPRI. (2010). *Power Generation Technology Data for Integrated Resource Plan of South Africa*. Electric Power Research Institute, California.
- Ervural, B. C., Evren, R., & Delen, D. (2018, March). *A multi-objective decision-making approach for sustainable energy investment planning*. *Renewable Energy*, 387-402.
- ES Components. (2017, October 11). *China takes the lead in adopting the all electric bus equipped with supercapacitors*. ESC [Online] <https://www.escomponents.com/blog/2017/10/11/china-takes-the-lead-in-adopting-the-all-electric-bus-equipped-with-supercapacitors>. [2018, October 04].
- Eskom. (2010, February). *Electricity Generation*. Eskom [Online] [http://www.eskom.co.za/Whatweredoing/ElectricityGeneration/Pages/Electricity\\_Generation.aspx](http://www.eskom.co.za/Whatweredoing/ElectricityGeneration/Pages/Electricity_Generation.aspx). [2018, January 18].
- Eskom. (2017, May). *About Electricity*. Eskom [Online] <http://www.eskom.co.za/AboutElectricity/FactsFigures/Documents/GX0001GenPlantMixRev19.pdf>. [2018, April 12].
- Eskom SOC. (2017, March 31). *Eskom's Integrated Report*. Eskom [Online] [http://www.eskom.co.za/IR2017/Documents/Eskom\\_integrated\\_report\\_2017.pdf](http://www.eskom.co.za/IR2017/Documents/Eskom_integrated_report_2017.pdf). [2018, April 12].
- Eskom SOC. (2018, March 28). *Electric Vehicle Industry*. Eskom [Online] <http://www.eskom.co.za/sites/idm/Business/Documents/Electric%20vehicle.pdf>. [2018, May 22].
- EU. (n.d.). *Concepts*. Tilastokeskus [Online] [http://www.stat.fi/meta/kas/kulutusmenot\\_en.html](http://www.stat.fi/meta/kas/kulutusmenot_en.html). [2017, August 15].
- European Commission. (2017, November). *Road Transport: Reducing CO<sub>2</sub> Emissions from Vehicles*. European Commission [Online] [https://ec.europa.eu/clima/policies/transport/vehicles/cars\\_en](https://ec.europa.eu/clima/policies/transport/vehicles/cars_en). [2018, May 23].
- EVIA. (2017, February 7). *EVIA 2016 Booklet*. SANEDI [Online] <http://www.sanedi.org.za/EVIA/images/EVIA%202016%20Booklet.pdf>. [2018, May 22].
- Expansion. (2018, March). *Country Comparison Brazil vs South Africa*. Country Economy [Online] <https://countryeconomy.com/countries/compare/brazil/south-africa>. [2018, March 14].
- EXpress, P. E. (2016, February 24). *E-bike a first for SA University*. News24 [Online] <https://www.news24.com/SouthAfrica/Local/PE-Express/e-bike-a-first-for-sa-university-20160222>. [2018, January 30].
- Farris, F. A. (2010, December). *The Gini Index and Measures of Inequality*. The Mathematical Association of America.

- Fiddaman, T. (1997). *Feedback Complexity in Integrated Climate-Economy Models*. PhD Thesis, MIT, MIT Sloan School of Management.
- Fiddaman, T. (1998). *A Feedback-Rich Climate-Economy Model*. 16<sup>th</sup> International Conference of the System Dynamics Society. Quebec.
- Fin24. (2017, May). *Revealed: Where and what SA super rich spend their money on*. FIN24 [Online] <https://www.fin24.com/Economy/revealed-where-and-on-what-sa-super-rich-spend-their-money-20170504-2>. [2017, November 12].
- Fischer, H., & Keating, D. (2017, August 4). *How eco-friendly are electric cars?* Deutsche Welle [Online] <http://www.dw.com/en/how-eco-friendly-are-electric-cars/a-19441437>. [2018, February 4].
- Fischer, M. (2017, October 10). *Electric Cars Are A Better Environmental Choice – In Spite Of Environmental Impact*. Vattenfall [Online] <https://news.vattenfall.com/en/article/electric-cars-are-better-environmental-choice-spite-environmental-impact>. [2018, February 2].
- Fisher, D. M. (2001-2006). *Lessons in Mathematics: A Dynamic Approach with Applications across the Sciences*. (J. Boutin, N. Maville, & S. Peterson, Eds.) United States: iSee Systems Inc.
- Foley, A. M., O Gallachoir, B. P., Hur, J., Baldick, R., & McKeogh, E. J. (2010, December). *A strategic review of electricity systems models*. *Energy*, 35(12), 4522-4530.
- Foley, A., Tyther, B., Calnan, P., & Ó Gallachóirab, B. (2013, January). *Impacts of Electric Vehicle charging under electricity market operations*. *Applied Energy*, 101, 93-102.
- Ford, A., & Yabroff, I. (1979, June). *Technical Documentation of the Electric Utility Policy and Planning Analysis Model*. Los Alamos National Laboratory report LA-7773-MS.
- Forrester, J. W. (1961). *Industrial Dynamics*. Cambridge, Massachusetts: MIT Press.
- Forrester, J. W. (1969). *Urban Dynamics*. Cambridge, Massachusetts: MIT Press.
- Forrester, J. W. (1971a). *World Dynamics*. Waltham, Massachusetts: Pegasus Communications.
- Forrester, J. W. (1995). *Learning and Renewal. The McKinsey Quarterly*(4).
- Forrester, J. W. (2009, July). *Learning through System Dynamics as Preparation for the 21st Century*. MIT.
- Forrester, J. W., & Senge, P. M. (1979, June 8). *Tests for building confidence in system dynamics models*. Clexchange.org [Online] <http://static.clexchange.org/ftp/documents/roadmaps/RM10/D-2926-7.pdf>. [2018, April 17].
- Fortmann-Roe, S. (2016). *Insightmaker: Features*. Insight Maker [Online] <https://insightmaker.com/features>. [ 2018, April 17].
- Fouquet, R. (2012, November). *Trends in income and price elasticities of transport demand (1850–2010)*. *Energy Policy*, 50, 62-71.
- Fuchs, H. U. (2006, December). *System Dynamics Modelling in Science and Engineering*. Mayaguez: University of Puerto Rico.
- Fullerton, D., Gan, L., & Hattori, M. (2015, January). *A model to evaluate vehicle emission incentive policies in Japan*. *Environmental Economics and Policy Studies*, 17(1), 79-108.
- Gardyn, R. (2002, November). *Defining Luxury: OH, THE GOOD LIFE*. Primedia Business Magazines & Media.

- Garwood, T. L., Hughes, B. R., Oates, M. R., O'Connor, D., & Hughes, R. (2018, January). *A review of energy simulation tools for the manufacturing sector*. *Renewable and Sustainable Energy Reviews*, 81(Part 1), 895-911.
- Bloomberg. (2016). *Gasoline Prices Around the World: The Real Cost of Filling Up*. Bloomberg [Online] <https://www.bloomberg.com/graphics/gas-prices/#20162:South-Africa:ZAR:1>. [2017, February 9].
- Gastwirth, J. L. (1971, November). *A General Definition of the Lorenz Curve*. *Econometrica*, 39(6).
- Gauteng Province. (2016, March). *Gauteng Province Household Travel Survey 2014*. Department of Road & Transport: Gauteng Province, South Africa.
- Gerssen-Gondelach, S. J., & Faaij, A. P. (2012, April). *Performance of batteries for electric vehicles on short and longer term*. *Journal of Power Sources*, 212, 111-129.
- Giampietro, M. (2012). *Energy Analysis for a Sustainable Future: Multi-Scale Integrated Analysis of Societal and Ecosystem Metabolism*. Routledge.
- Giampietro, M., Mayumi, K., & Sorman, A. (2012). *The Metabolic Pattern of Societies: Where Economists Fall short*. Routledge.
- Giffi, C., Vitale, J., Drew, M., Kuboshima, Y., & Sase, M. (2011, October). *Unplugged: Electric vehicle realities versus consumer expectations*. Deloitte.
- GIZ. (n.d.). *Transfer-Project*. Transfer: Towards climate friendly transport technologies and measures [Online] <http://transferproject.org/about-us/>. [2018, January 26].
- Gomez, J. C., & Morcos, M. M. (2003). *Impact of EV Battery Chargers on Power Quality of Distribution Systems*. *IEEE Transactions on Power Delivery*, 18, 3, 975-981.
- Gong, Q., Midlam-Mohler, S., Marano, V., & Rizzoni, G. (2012). *Distribution of PEV Charging Resources to Balance Transformer Life and Customer Satisfaction*. IEEE International Electric Vehicle Conference (IEVC).
- Goodall, C. (2017, January). *How to reduce your carbon footprint*. The Guardian [Online] <https://www.theguardian.com/environment/2017/jan/19/how-to-reduce-carbon-footprint>. [2017, December 1].
- Gorbea, C., Lindemann, U., & de Weck, O. (2011). *System Dynamics Modeling Of New Vehicle Architecture Adoption*. 18<sup>th</sup> International Conference on Engineering Design (ICED 11), 278-289. Denmark.
- Gorton, M. (2011, November 10). *Solar-powered Electric Vehicle Charging Stations Sprout Up Nationally*. *Renewable Energy World* [Online] <https://www.renewableenergyworld.com/articles/print/pvw/volume-3/issue-5/solar-energy/solar-powered-electric-vehicle-charging-stations-sprout-up-nationally.html>. [2018, June 15].
- Grahn, P. (2014). *Electric Vehicle Charging Modeling*. *Doctoral Thesis*. Stockholm, Sweden: School of Electrical Engineering, Royal Institute of Technology.
- Grant, A. (2014, January). *Plug-in Hybrid and Battery Electric Vehicles in South Africa: Market Forecasts*. University of Cape Town, School of Economics. Cape Town: University of Cape Town.

- Green Car Reports. (2016). *Electric-car battery costs*. Green Car Reports [Online] [http://www.greencarreports.com/news/1103667\\_electric-car-battery-costs-tesla-190-per-kwh-for-pack-gm-145-for-cells](http://www.greencarreports.com/news/1103667_electric-car-battery-costs-tesla-190-per-kwh-for-pack-gm-145-for-cells). [2016, June 10].
- Guerra, E. (2015, February). *The geography of car ownership in Mexico City: a joint model of households' residential location and car ownership decisions*. *Journal of Transport Geography*, 43, 171-180.
- Guzzella, L., & Onder, C. H. (2010). *Introduction to Modeling and Control of Internal Combustion Engine Systems*. Chennai, India: Springer.
- Haddadian, G., Khodayar, M., & Shahidehpour, M. (2015). *Accelerating the Global Adoption of Electric Vehicles: Barriers and Drivers*. *The Electricity Journal*, 28, 53-68.
- Halper, J., & Pearl, J. (2005). *Causes and Explanations: A Structural-Model Approach. Part I: Causes*. 843–887. *Brit. J. Phil. Sci.*
- Haraldsson, H. V. (2000, January). *Introduction to Systems and Causal Loop Diagrams*. Sweden: Lunds University.
- Hardman, D., Rotheran, A., Jupe, S., & Hawkins, D. (2012). *Electric Vehicles: The Barriers to Power System Integration*.
- Harrison, G., & Thiel, C. (2017, January). *An exploratory policy analysis of electric vehicle sales competition and sensitivity to infrastructure in Europe*. *Technological Forecasting and Social Change*, 114, 165-178.
- Harrop, P. (2011, November). *The death of lead acid batteries*. *Electric Vehicle Research* [Online] <https://www.electricvehiclesresearch.com/articles/3921/the-death-of-lead-acid-batteries>. [2018, May 22].
- Hatziaargyriou, N., Pecas Lopes, J. A., Bower, E. T., & Strunz, K. (2012). *Impact of Electric and Plug-in Hybrid Vehicles on Grid Infrastructure - Results from the MERGE project. CIGRE no. C6-201*.
- Haw, M., & Hughes, A. (2007). *Clean Energy and Development for South Africa: Background Data*. Cape Town: British High Commission South Africa & Energy Research Centre.
- Hekimoğlu, M., & Barlas, Y. (2010). *Sensitivity analysis of system dynamics models by behavior pattern measures. 28<sup>th</sup> International Conference of the System Dynamics Society*. Seoul: System Dynamics Society.
- Held, M. (n.d.). *Mobile and eco-friendly – when are electric cars a sensible option?* Fraunhofer Institute for Building Physics IBP [Online] [https://www.ibp.fraunhofer.de/en/Press/Research\\_in\\_focus/Archives/February\\_electric-cars.html](https://www.ibp.fraunhofer.de/en/Press/Research_in_focus/Archives/February_electric-cars.html). [2018, May 23].
- Herring, H., & Roy, R. (2007). *Technological innovation, energy efficient design and the rebound effect*. *Technovation*, 27(4), 194-203.
- Hidrue, M. K., Parsons, G. R., Kempton, W., & Gardner, M. P. (2011, September). *Willingness to pay for electric vehicles and their attributes*. *Research and Energy Economics*, 33(3), 686-705.
- Høj, J.-C., & Lewis, C. (2015, May 27). *OECD Economic Surveys: South Africa 2015*. Secretary-General of the OECD.

- Høyer, K. G. (2007, November). *The history of alternative fuels in transportation: The case of electric and hybrid cars*. Utilities Policy 16 (2008) 63e71. (ScienceDirect, Compiler) Norway: Elsevier.
- Hume, J. (n.d.). *MRPC Regional Energy Plan Application for Federal Assistance*.
- Hunter, S. (2016, May 20). *An Exact Breakdown Of Poor, Middle And Rich Spending Habits In SA*. 2 Oceans Vibe [Online] <http://www.2oceansvibe.com/2016/05/20/his-is-how-different-classes-of-south-africans-spend-their-money/>. [2017, November 17].
- IDAHO. (2015, May 4). *How Do Gasoline & Electric Vehicles Compare?* Advanced Vehicle Testing Activity [Online] <https://avt.inl.gov/sites/default/files/pdf/fsev/compare.pdf>. [2018, February 1].
- IDC. (2013, December). *Industrial Development Corporation South African Economy: An Overview of Key Trends Since 1994*. SCRIBD [Online] <https://www.scribd.com/document/308793992/IDC-R-I-Publication-Overview-of-Key-Trends-in-SA-Economy-Since-1994>. [2018, January 19].
- IEA. (2002). *World energy outlook: Energy and Poverty*. International Energy Agency [Online] [http://www.worldenergyoutlook.org/media/weowebiste/2008-1994/weo2002\\_part1.pdf](http://www.worldenergyoutlook.org/media/weowebiste/2008-1994/weo2002_part1.pdf). [2018, May 17].
- IEA. (2011). *Technology Roadmap: Electric and Plug-in Hybrid Electric Vehicles*. France: International Energy Agency.
- IEA. (2013, April). *Global EV Outlook. Understanding the Electric Vehicle Landscape to 2020*.
- IEA. (2016). *Beyond one million electric cars. Global EV Outlook 2016*. France.
- IEA. (2017). *Global EV Outlook 2017: Two million and counting*. International Energy Agency.
- IEC. (2017, February). *Electric vehicle conductive charging system - Part 1: General requirements*. International Electrotechnical Commission Webstore [Online] <https://webstore.iec.ch/publication/33644>. [2018, May 22].
- Illsey, R., & Le Grand, J. (1987). *The measurement of inequality in health*. Health and Economics, 13-36. (A. Williams, Ed.) London: MacMillan.
- Index Mundi. (n.d.). *South Africa - Household final consumption expenditure*. Index Mundi [Online] <https://www.indexmundi.com/facts/south-africa/household-final-consumption-expenditure>. [2018, May 16].
- InsideEVs. (2013, December 8). *81% of Electric Vehicle Charging is Done at Home*. Inside EVs [Online] <https://insideevs.com/most-electric-vehicle-owners-charge-at-home-in-other-news-the-sky-is-blue/>. [2018, June 17].
- Intel. (2012). *Case Study: PEP Stations, Electric Vehicle Charging*. USA.
- Intriligator, M. D. (2004, December 1). *Chapter 3 Economic and econometric models*. Handbook of Econometrics, 1, 181-221.
- IRENA. (2017). *Electricity Storage And Renewables: Costs And Markets To 2030*. Abu Dhabi: International Renewable Energy Agency.
- IRR. (2014). *Eighty20, XtracT based on AMPS 2014. Individual January–December 2014 data*.
- IRR. (2015, April). *IRR Calculations of Vehicle Sales Based on NAAMSA data*.
- IRR. (2017). *2016 87th Annual Report*. South African Institute of Race Relations, Melville, South Africa.

- iSee Systems. (2016). *iSee System Products*. iSee Systems [Online]  
<http://www.iseesystems.com/software/Education/StellaSoftware.aspx>. [2017, January 14]
- iSee Systems. (n.d.). *Building a Simple Interface*. iSee Systems [Online]  
[https://www.iseesystems.com/resources/help/v1-6/Content/06-Building\\_Interfaces/1InterfaceBuildingExample.htm](https://www.iseesystems.com/resources/help/v1-6/Content/06-Building_Interfaces/1InterfaceBuildingExample.htm). [2018, May 28].
- Jacobs, D., Bleijenbergh, I. L., & Vennix, J. (2011). *Supporting decision-makers in managing stock-flow problems: The effects of oral feedback on reasoning and decision-making*. Nijmegen, Netherlands.
- JATO Dynamics. (2013, December). *Cars and Luxury Goods - Complements or Substitutes for Share of Consumers Wallet?* Euromonitor International.
- Jha, A. (2009, December). *Government departments cut CO<sub>2</sub> emissions by 10%*. The Guardian [Online] <https://www.theguardian.com/environment/2009/dec/18/carbon-emissions-climate-change>. [2017, December 13].
- Johannesburg City Review Report*. (2017, August). Euromonitor [Online]  
<http://www.euromonitor.com/johannesburg-city-review/report>. [2017, December 13].
- Johnson-Laird, P. (1999). *Mental Models*. In R. A. Wilson, & F. C. Keil (Eds.), *The MIT Encyclopedia of the Cognitive Sciences* (pp. 525-526). Cambridge: MIT Press.
- Johnson-Laird, P. (2010, September). *Mental models and human reasoning*. Princeton: PNAS.
- Jones, B. G., & Kone, S. (1996, April). *An exploration of relationships between urbanization and per capita income: United States and countries of the world*. The Journal of the Regional Science Association International, 75(2), 135-154.
- Jones, N. A., Ross, H., Lynam, T., Perez, P., & Leitch, A. (2011, March). *Mental Models: An Interdisciplinary Synthesis of Theory and Methods*. Ecology and Society, 16(1).
- Jordaan, W. (2016). *Electric Vehicle Predictions for South Africa*. Gridcars [Online]  
<http://www.gridcars.net/electric-vehicle-predictions-south-africa/>. [2017, November 9].
- Joseph, K. (2017, May 02). *Quality of Life Survey 2015*. The Gauteng City-Region Observatory [Online] [http://www.gcro.ac.za/media/redactor\\_files/GCRO\\_QoL\\_2015\\_Press\\_pack\\_low\\_res.pdf](http://www.gcro.ac.za/media/redactor_files/GCRO_QoL_2015_Press_pack_low_res.pdf). [2018, February 28].
- Kaasa, A. (2003). *Factors Influencing Income Inequality In Transition Economies*. Tartu: Tartu University Press.
- Kaczmarczyk, V., Fiedler, P., Štohl, R., & Bradáč, Z. (2012). *Electric vehicles charger as a part of home area network*. IFAC Proceedings , 45, 180-185. IFAC .
- Kalhammer, F. K., Kamath, H., Duvall, M., Alexander, M., & Jungers, B. (2009, May). *Plug-In Hybrid Electric Vehicles: Promise, Issues and Prospects*. EVS24 International Battery, Hybrid and Fuel Cell Electric Vehicle Symposium 1. Norway: ResearchGate.
- Kapferer, J.-N. (2012, September-October). *Abundant rarity: The key to luxury growth*. Business Horizons, 55(5), 453-462.
- Kaplan, M. (1996). *Decision Theory as Philosophy*. New York: Cambridge University Press.



- Kavousian, A., Rajagopal, R., & Fischer, M. (2013, June). *Determinants of residential electricity consumption: Using smart meter data to examine the effect of climate, building characteristics, appliance stock, and occupants' behavior*. *Energy*, 55, 184-194.
- Keating, E. (1999, August). *Issues to Consider While Developing a System Dynamics Model*. Kellogg Graduate School of Management.
- Kershoff, G. (2000, December). *Measuring Business and Consumer Confidence in South Africa*. Bureau of Economic Research [Online] <https://www.ber.ac.za/Knowledge/pkDownloadDocument.aspx?docid=4128>. [2018, February 27].
- Khutsoane, B. (2016, December). *Electric vehicle industry association (EVIA) launch*. Department of Transport. South Africa.
- Kierzkowski, H. (2009, October). *A New New Global Auto Industry? Trade and Industry in Asia Pacific: History, Trends and Prospects*. Australia.
- Klee, H., & Allen, R. (2011). *Simulation of Dynamics Systems with MATLAB and Simulink*. London: CRC Press.
- Kljajic, M., Škraba, A., & Rozman, Č. (2012, December). *Methodology of system dynamics for decision support in agriculture*. *Agricultura*, 9(1-2), 7-16.
- Knight, D. S., & Thompson, W. (2018, February 13). *Can electric vehicles rescue Eskom?* Moneyweb [Online] <https://www.moneyweb.co.za/moneyweb-opinion/can-electric-vehicles-rescue-eskom/>. [2018, May 23].
- Knowler, W. (2017, December 17). *Balloon-payment car deals on the up*. Business Live [Online] <https://www.businesslive.co.za/bt/money/2017-12-16-balloon-payment--car-deals-on-the-up/>. [2018, June 15].
- Knupfer, S. M., Hensley, R., Hertzke, P., Schaufuss, P., Laverty, N., & Kramer, N. (2017, January). *Electrifying insights: How automakers can drive electrified vehicle sales and profitability*. Advanced Industries. McKinsey Automotive and Innovation Center (MAIC).
- Koegelenberg, T., & Pillay, N. S. (2015). *A System Dynamics Approach to Simulating the South African Forestry & Logging Sector's Electricity Demand*. 33<sup>rd</sup> International System Dynamics Conference. Boston: System Dynamics Society.
- Krishnan, V., Ho, J., Hobbs, B. F., Liu, A. L., McCalley, J. D., Shahidehpour, M., et al. (2016, May). *Co-optimization of electricity transmission and generation resources for planning and policy analysis: review of concepts and modeling approaches*. *Energy Systems*, 7(2), 297-332.
- Kumar, A. H., Paton, C., & Muller, J. (2014). *Electric Vehicles 2014, RES/RR/13/35495*. Frost & Sullivan. Johannesburg. South Africa.
- Kwon, T. H. (2006). *The Determinants of the Changes in Car Fuel Efficiency in Great Britain (1978-2000)*. *Energy Policy*, 2405-2415.
- Lamprecht, N. (2017, April). *Automotive Export Manual 2017*. Arcadia, South Africa: AIEC.
- Lane, B., & Potter, S. (2007). *The Adoption of Cleaner Vehicles in the UK: Exploring the Consumer Attitude-Action Gap*. *Journal of Cleaner Production*, 1085-1092.
- Lane, D. C. (2007). *The Power of the Bond Between Cause and Effect: Jay Wright Forrester and the Field of System Dynamics*. *System Dynamics Review*(23), 95-118.

- Langley, P. (2012, May). *Eskom Electric Vehicle Programme*. Eskom SOC. Johannesburg, South Africa.
- Langley, P. (2015, January). *Electric Vehicles Research Results 2014*. Eskom SOC. Johannesburg, South Africa.
- Langley, P. (2016). *Electric Vehicle Results. Report 1789591*. Eskom SOC. Johannesburg, South Africa.
- Laszlo, A., & Krippner, S. (1998). *Systems Theories: Their Origins, Foundations, and Development*. Amsterdam: Elsevier.
- LCTSA. (2017, April). *Mobility: A Time for Change (Part 1)*. Low Carbon Transport South Africa [Online] <http://www.lctsa.co.za/2017/04/03/mobility-a-time-for-change/>. [2018, January 30].
- Lee, J., & Mo, J. (2011, September 22). *Analysis of Technological Innovation and Environmental Performance Improvement in Aviation Sector*. International Journal of Environmental Research and Public Health, 8(9), 3777-3795.
- Lehohla, P. (2012). *Living Conditions Survey 2008/9. Poverty Profile of South Africa*. Pretoria: StatsSA.
- Lescaroux, F. (2010, May). *Car Ownership in Relation to Income Distribution and Consumers' Spending Decisions*. Journal of Transport Economics and Policy (JTEP), 44(2), 207-230.
- Liao, F., Molin, E., & Van Wee, B. (2016). *Consumer preferences for electric vehicles: a literature review*. Transport Reviews, 37(3), 252-272.
- Litman, T. (2017, February 27). *Understanding Transport Demands and Elasticities*. Victoria Transport Policy Institute [Online] <http://www.vtpi.org/elasticities.pdf>. [2018, May 21].
- Liu, X., Hildebrandt, D., & Glasser, D. (2012, January 20). *Environmental impacts of electric vehicles in South Africa*. South African Journal of Science, 108(1/2.603).
- Locatelli, B., Aldunce, P., Fallot, A., Le Coq, J.-F., Sabourin, E., & Tapasco, J. (2017). *Research on Climate Change Policies and Rural Development in Latin America: Scope and Gaps*. Sustainability, 9(10), 1831.
- Lombard, M., Cameron, B., Mokonyama, M., & Shaw, A. (2007, July). *Report on Trends in Passenger Transport in South Africa*. Midrand, South Africa: Development Bank of South Africa.
- Lopes, J. A., Soares, F. J., & Almeida, M. R. (2011). *Integration of Electric Vehicles in the Electric Utility Systems*. Proceedings of the IEEE, 99, 1, 168-183.
- Lorenz, M. C. (1905). *Methods of measuring the concentration of wealth*. Journal of the American Statistical Association, 9(70), 209-219.
- Louw, A. (2016, September 19). *The Futran System: Breeding the Paradigm Shift*. PodCar City & Advanced Transit: Automated mobility on demand. Belgium: Podcar City.
- Lubrano, M. (2010, January). *Lorenz curves and parametric distributions*. The Econometrics of Inequality and Poverty.
- Lumina Decision Systems. (2016). *Analytica Training*. Lumina Decision Systems [Online] <http://www.lumina.com/services/analytica-training>. [2018, May 21].
- MacColl, B. (2013, June 11). *Eskom Electric Vehicle. Preparing for a possible e-mobility future*. Eskom SOC. Johannesburg, South Africa.



- Mahmud, K., Town, G. E., Morsalin, S., & Hossain, M. J. (2017, November). *Integration of electric vehicles and management in the internet of energy*. Renewable and Sustainable Energy Reviews. Elsevier.
- Makgetla, N., & Fotoyi, A. (2016). *The Real Economy Bulletin, Provincial Review 2016*. Trade & Industry Policy Strategies (TIPS) [Online]  
[https://www.google.com/url?sa=t&rct=j&q=&esrc=s&source=web&cd=8&cad=rja&uact=8&ved=0ahUKewj2-vPIlozaAhUKKsAKHTEMBuIQFghfMAC&url=http%3A%2F%2Fwww.tips.org.za%2Fmanufacturing-data%2Fthe-real-economy-bulletin%2Fprovincial-review%2Fitem%2Fdownload%2F1515\\_baad](https://www.google.com/url?sa=t&rct=j&q=&esrc=s&source=web&cd=8&cad=rja&uact=8&ved=0ahUKewj2-vPIlozaAhUKKsAKHTEMBuIQFghfMAC&url=http%3A%2F%2Fwww.tips.org.za%2Fmanufacturing-data%2Fthe-real-economy-bulletin%2Fprovincial-review%2Fitem%2Fdownload%2F1515_baad). [2018, March 27].
- Maly, T., & Petzold, L. R. (1996, February). *Numerical methods and software for sensitivity analysis of differential-algebraic systems*. Applied Numerical Mathematics, 20(1-2), 57-79.
- Manamela, M., Mabaso, K., & Ligudu, L. (2017, March). *Gross Domestic Product Fourth Quarter 2016. Statistical Release P0441*. South Africa: Stats SA.
- Markard, J., & Truffer, B. (2008). *Technological innovatin systems and the multi-level perspective: Towards an integrated framework*. Research Policy, 37, 596-615.
- Markowitz, M. (2013, February 22). *Wells to wheels: electric car efficiency*. Matter 2 Energy [Online]  
<https://matter2energy.wordpress.com/2013/02/22/wells-to-wheels-electric-car-efficiency/>. [2018, February 1].
- Martin, L. A. (1997). *An Introduction to Feedback*. MIT System Dynamics in Education Project. Massachusetts Institute of Technology.
- McCarthy, C. (2005). *Productivity Performance In Developing Countries*. Country Case Studies: South Africa.
- McCarthy, P. S. (1996, August). *Market Price and Income Elasticities of New Vehicle Demands*. The Review of Economics and Statistics, 78(3), 543-547.
- Mckinsey & Company. (2017, January). *Electrifying insights: How automakers can drive electrified vehicle sales and profitability*. McKinsey [Online] <https://www.mckinsey.com/industries/automotive-and-assembly/our-insights/electrifying-insights-how-automakers-can-drive-electrified-vehicle-sales-and-profitability>. [2018, February 1].
- Meadows, D. H. (1980). *The Unavoidable A Priori*. In J. Randers, Elements of the System Dynamics Method. United States of America: Productivity Press.
- Meadows, D. H., Meadows, D. L., Randers, J., & Behrens, W. W. (1972). *The Limits to Growth: A Report for the Club of Rome's Project on the Predicament of Mankind*. New York: Universe Books.
- Medlock, K. B., & Soligo, R. (2002, May). *Car Ownership and Economic Development with Forecasts to the Year 2015*. Journal of Transport Economics and Policy (JTEP), 36(2), 163-188.
- Melton, K. I. (2004, July). *Detailed and Dynamic Complexity*. Dahlonega: North Georgia College & State University.
- Memela, N., & Pillay, N. S. (2015). *Using System Dynamics to Simulate the Eskom's Key Value Chain Key Performance Indicators*. 3rd Annual System Dynamics Conference - South Africa. Johannesburg: South African System Dynamics Chapter.

- Merven, B., Stone, A., Hughes, A., & Cohen, B. (2012). *Quantifying the energy needs of the transport sector for South Africa: A bottom-up model*. University of Cape Town. Energy Research Centre.
- Meyer, P. (1994). *Bi-Logistic Growth*. *Technological Forecasting and Social Change*, 47, 89-102.
- Mi, C., & Masrur, M. A. (2017). *Hybrid Electric Vehicles: Principles and Applications with Practical Perspectives, Second Edition*. John Wiley & Sons.
- Ministry of Transport Chile. (2012, February). *Proposal E-mobility Readiness Plan Chile*. Ecofys [Online] [https://www.ecofys.com/files/files/ecofys\\_2012\\_nama\\_e-mobility\\_readiness\\_plan\\_chile.pdf](https://www.ecofys.com/files/files/ecofys_2012_nama_e-mobility_readiness_plan_chile.pdf). [2018, May 23].
- Mirjat, N. H., Uqaili, M. A., Harijan, K., Mustafa, M. W., Rahman, M., & Khan, W. A. (2018, March 27). *Multi-Criteria Analysis of Electricity Generation Scenarios for Sustainable Energy Planning in Pakistan*. *Energies* 2018, 11(14), 757.
- Modise, D., & Mahotas, V. (2011, December 16). *South African Energy Sector*. United States Energy Association [Online] [https://www.usea.org/sites/default/files/event-file/497/South\\_Africa\\_Country\\_Presentation.pdf](https://www.usea.org/sites/default/files/event-file/497/South_Africa_Country_Presentation.pdf). [2018, May 17].
- Moeckel, R., & Yang, D. (2016). *Car Ownership and the Impact of Built Environment, Demographics and Transport Systems*. *Journal of Civil Engineering and Architecture*, 10, 587-595.
- Mok, B. (2017, October). *Types of Batteries Used for Electric Vehicles*. Stanford University Coursework [Online] <http://large.stanford.edu/courses/2016/ph240/mok2/>. [2018, May 22].
- Monga, P. (2001). *A System Dynamics Model of the Development of New Technologies for Ship Systems*. MSc In Industrial and Systems Engineering, Virginia Polytechnic Institute and State University, Falls Church.
- Montmasson-Clair, G. (2017, March). *Policy Brief 2/2017: Electricity supply in South Africa: Path dependency or decarbonisation?* Department of Trade & Industry Policy Strategies [Online] [https://www.google.com/url?sa=t&rct=j&q=&esrc=s&source=web&cd=6&cad=rja&uact=8&ved=0aHUKewiCvrCitYzbAhXIK8AKHY5oBPAQFghLMAU&url=https%3A%2F%2Fwww.tips.org.za%2Fpolicy-briefs%2Fitem%2Fdownload%2F1350\\_a698ceb76e4c60eea22c36a1af47ded6&usq=AOvVaw0fMERD6J5exiQ](https://www.google.com/url?sa=t&rct=j&q=&esrc=s&source=web&cd=6&cad=rja&uact=8&ved=0aHUKewiCvrCitYzbAhXIK8AKHY5oBPAQFghLMAU&url=https%3A%2F%2Fwww.tips.org.za%2Fpolicy-briefs%2Fitem%2Fdownload%2F1350_a698ceb76e4c60eea22c36a1af47ded6&usq=AOvVaw0fMERD6J5exiQ). [2018, May 17].
- Moon, Y. B. (2016, August 22). *Simulation modelling for sustainability: a review of the literature*. *International Journal of Sustainable Engineering*, 10(1), 2-19.
- Morapedi, K., & Makhari, M. (2018, April). *National Transport Master Plan (NATMAP) 2050*. Department of Transport [Online] [http://www.satc.org.za/assets/4a\\_morapedi.pdf](http://www.satc.org.za/assets/4a_morapedi.pdf). [2018, May 23].
- Morsy, S. (2018). *Electric Vehicle Outlook 2018, BNEF's annual long-term forecast of global electric vehicle (EV) adoption to 2040*. Bloomberg New Energy Finance [Online] <https://about.bnef.com/electric-vehicle-outlook/>. [2018, May 23].
- Mothibi, G. (2015). *An Assessment of Car Buyers' Understanding of Balloon Payment Method in Relation to the National Credit Act in South Africa*. *Journal of Law, Policy and Globalization*, 35.
- Stats SA. (2016, December). *Motor Trade Sales P6343.2*. Stats SA.
- Murphy, W. W. (2016). *Consumer Culture and Society*. California, United States: SAGE Publications.

- NAAMSA. (2017, January). *National Association of Automobile Manufacturers of South Africa*.  
NAAMSA [Online] <http://www.naamsa.co.za/flash/index.html>. [2017, February 2017].
- Nagler, J. (1999, April 19). *Notes on Simultaneous Equations and Two Stage Least Squares Estimates*.
- Naill, R. F. (1976). *User's guide to the COAL1 model*. System Dynamics Group, Thayer School of Engineering.
- NAMA. (2010). *Rollout of electric private passenger vehicles*. NAMA [Online] [http://www.nama-database.org/index.php/Rollout\\_of\\_electric\\_private\\_passenger\\_vehicles](http://www.nama-database.org/index.php/Rollout_of_electric_private_passenger_vehicles). [2018, May 22].
- North West Provincial Government. (2015). *Estimates of Provincial Revenue and Expenditure 2015/16*. Department: Finance, North West Provincial Government. Mmabatho, South Africa.
- National Treasury. (2013, May). *Carbon Tax Policy Paper*. National Treasury [Online] <http://www.treasury.gov.za/public%20comments/Carbon%20Tax%20Policy%20Paper%202013.pdf>. [2018, May 17].
- National Treasury. (2017, February 22). *Budget Review 2017*. National Treasury [Online] <http://www.treasury.gov.za/documents/national%20budget/2017/review/FullBR.pdf>. [2018, March 16].
- Nel, W. (2011). *Eskom Technology Systems Model Using System Dynamics*. Eskom SOC. Johannesburg, South Africa.
- Nel, W., & Pillay, N. S. (2013). *Determinants of 21 century Energy Security using Systems Thinking Principles*. 32nd International Energy Workshop. IEW.
- Nemry, F., & Brons, M. (2010). *Market penetration scenarios of electric drive vehicles*. Plug-in Hybrid and Battery Electric Vehicles. Luxembourg: Publications Office of the European Union.
- NERSA. (2017, March). *Electricity Supply Statistics dor South Africa 2012*. National Energy Regulator of South Africa [Online] <http://www.nersa.org.za/Admin/Document/Editor/file/News%20and%20Publications/Publications/Current%20Issues/Electricity%20Supply%20Statistics/Electricity%20Supply%20Statistics%20for%20South%20Africa%202012.pdf>. [2018, May 17].
- Nieftagodien, S., & Van der Berg, S. (2007). *Consumption patterns and the black middle class: The role of assets*. Stellenbosch University, Department of Economics.
- Nieuwenhuis, P. (2018, February). *Alternative business models and entrepreneurship: The case of electric vehicles*. The International Journal of Entrepreneurship and Innovation, 19(1), 33-45.
- NMMU. (2016, March 1). *Shared e-bikes make for speedy inter-campus commute*. Nelson Mandela University [Online] <http://soe.mandela.ac.za/News/Shared-e-bikes-make-for-speedy-inter-campus-commut>. [2018, February 1].
- Ntsoane, M., & Pillay, N. S. (2015). *Hydro Pumped Storage Dynamics*. 33<sup>rd</sup> International System Dynamics Conference. System Dynamics Society.
- NWDC. (2017, September 7). *Economic Data Report 1st Quarter 2017/18*. North West Development Corporation [Online] [http://nwdc.co.za/wp-content/uploads/2017/09/NWDC\\_Economic-Data-Report-Q1-2017.2018.pdf](http://nwdc.co.za/wp-content/uploads/2017/09/NWDC_Economic-Data-Report-Q1-2017.2018.pdf). [2018, January 26].

- Occams Business Research and Consulting. (2017). *Global Electric Vehicle Market Research Report Insights, Opportunity Analysis, Market Shares and Forecast, 2017 - 2023*. Occams Business Research and Consulting. Research and Markets.
- Odendaal, N. (2017, September 21). *Eskom's unsustainable business model in need of proactive reform*. Engineering News [Online] <http://www.engineeringnews.co.za/print-version/eskoms-unsustainable-business-model-in-need-of-proactive-reform-eberhard-2017-09-21>. [2018, April 1].
- OECD. (2017, July). *Economic Surveys: South Africa 2017*. Paris: OECD Publishing.
- OECD Statistics Directorate. (2016, October 6). *Statistical Insights: What does GDP per capita tell us about households' material well-being?* OECD [Online] <http://oecdinsights.org/2016/10/06/gdp-per-capita-households-material-well-being/>. [2018, June 14].
- Olivier, J. G., Janssens-Maenhout, G., Muntean, M., Jeroen, A. H., & Peters, J. A. (2016). *Trends in Global CO<sub>2</sub> Emissions: 2016 Report*. PBL Netherlands Environmental Assessment Agency.
- Olsina, F., Garces, F., & Haubrich, H. J. (2006, August). *Modeling long-term dynamics of electricity markets*. *Energy Policy*, 34(12), 1411-1433.
- Palinski, M. (2017). *A Comparison of Electric Vehicles and Conventional Automobiles: Costs and Quality Perspective*. Bachelor Thesis in Business Administration, Yrkeshogskolan NOVA.
- Parker, C. (2017, August). *Assessing the Viability of e-Mobility: Assessing the Viability of e-Mobility*. Johannesburg: Frost & Sullivan.
- Parmar, H. (2017, May). *Sustainable Transport and Mobility for Cities Workshop - eThekweni Municipality*. uYilo eMobility Programme [Online] [https://www.sanedi.org.za/Cleaner%20Mobility/images/Presentations/uYilo\\_UNIDO\\_Sustainable\\_Transport\\_and\\_Mobility\\_for\\_Cities\\_workshop\\_HitenParmar\\_320170330.pdf](https://www.sanedi.org.za/Cleaner%20Mobility/images/Presentations/uYilo_UNIDO_Sustainable_Transport_and_Mobility_for_Cities_workshop_HitenParmar_320170330.pdf). [2018, January 17].
- Pasaoglu, G., Harrison, G., Jones, L., Hill, A., Beaudet, A., & Thiel, C. (2016, March). *A system dynamics based market agent model simulating future powertrain technology transition: Scenarios in the EU light duty vehicle road transport sector*. *Technological Forecasting and Social Change*, 104, 133-146.
- Paul, T. K., & Aisu, H. (2012). *Management of Quick Charging of Electric Vehicles Using Power from Grid and Storage Batteries*. IEEE International Electric Vehicle Conference (IEVC).
- Perez-Quiros, G. (2018, January-March). *Discussion of the paper "Deciding between alternative approaches in macroeconomics"*. *International Journal of Forecasting*, 34(1), 139-141.
- Pettinger, T. (2015, October 21). *Income inequality by income decile*. Economics Help [Online] <https://www.economicshelp.org/blog/14853/economics/income-inequality-by-income-decile/>. [2018, May 16].
- Phillips, M. (2014, October). *Why electricity demand is linked to GDP*. Market Realist [Online] <http://marketrealist.com/2014/10/why-electricity-demand-is-linked-to-gdp/>. [2017, November 10].
- Pillay, N. S. (2014, April). *Using System Dynamics to Explore Gini Coefficient Parametrics*. MSc report. University of Cape Town, South Africa.
- Pillay, N. S. (2015, July). *Gini Coefficient Parametrics*. 33<sup>rd</sup> International System Dynamics Conference. System Dynamics Society.

- Pillay, N. S., Brent, A. C., & Musango, J. K. (2018, October). *An Adapted System Dynamics Approach to Determine the Linkage Between Battery Electric Vehicle Affordability and Real Disposable Income in South Africa. 29th Annual Conference of SAIEE*. Stellenbosch: SAIEE.
- Pillay, N. S., Brent, A. C., & Musango, J. K. (2018, August). *Drivers Impacting BEV Production Cost and Monthly Repayments*. The 36th International Conference of the System Dynamics Society. Reykjavik, Iceland: System Dynamics Society.
- Pillay, N. S., Nel, W., & Cohen, B. (2014). *A system dynamics approach to exploring the relationship between income distribution and residential electricity consumption*. 32nd International System Dynamics Conference. System Dynamics Society.
- Pillay, N. S., Nel, W., & Cohen, B. (2014, April). *Using System Dynamics to Explore Gini Coefficient Parametrics*. Cape Town, South Africa: University of Cape Town.
- Pillay, N., Webb, W., Booyens, D., & Von Berg, K. (2012). *Simulating Customer Value Perception and The Distribution Business*. Eskom SOC. Johannesburg, South Africa.
- Population Pyramid. (2018). *Population Pyramids of the World from 1950 to 2100*. Retrieved January 15, 2018, from Population Pyramid: <https://www.populationpyramid.net/south-africa/2050/>
- Posada, F. (2018, January). *South Africa's New Passenger Vehicle CO<sub>2</sub> Emission Standards*. International Council on Clean Transportation.
- Post, W. (2017, May 11). *Comparison of Energy Efficiency and CO<sub>2</sub> of Gasoline and Electric Vehicles*. The Energy Collective: The worlds best thinkers on energy and climate [Online] <http://www.theenergycollective.com/willem-post/2404277/comparison-energy-efficiency-co2-gasoline-electric-vehicles>. [2018, May 23].
- Pouris, A., & Thopil, G. A. (2015, March). *Long Term Forecasts Of Water Usage For Electricity Generation: South Africa 2030 . Report No. 2383/1/14 . Water Research Commission*.
- Powersim Software. (2016). *Powersim*. Powersim [Online] <http://www.powersim.com/>. [2017, August 23].
- Provincial Treasury. (2015, September). *Analysis Of Income Inequality In Mpumalanga, 1996-2014*. Provincial Treasury - Mpumalanga Province, South Africa.
- Provincial Economic Review and Outlook 2017*. (2017). Cape Town: Western Cape Government, Provincial Treasury.
- Pugh, A. L., & Richardson, G. P. (1981). *Introduction to System Dynamics Modeling with Dynamo*. Cambridge, MA: MIT Press.
- Qian, K., Zhou, C., & Yuan, Y. (2012). *Impact of fully electric vehicle battery charging loads on the load demand of distribution systems*.
- Quadrat-Ullah, H. (2005). *Structural validation of System Dynamics and Agent-based Simulation Models*. Proceedings of the 19th European Conference on Modelling and Simulation. Latvia: ECMS.
- R.L Polk & Co. (2009, March). *U.S. Vehicle median increased in 2008, accprding to Polk*. Autonews [Online] <http://www.autonews.com/assets/pdf/ca6029933.pdf>. [2018, June 6].

- Rafique, M. M., Ali Shakir, M., & Chohan, G. Y. (2018, January). *Statistical and Econometric Estimation of Current and Projected Energy Utilization in Pakistan*. NFC IEFER Journal of Engineering and Scientific Research, 5(2).
- Ramayia, J. (2013, May 9). *New road map proposes possible incentives for locally made electric vehicles*. Urban Earth [Online] <http://www.urbanearth.co.za/articles/new-road-map-proposes-possible-incentives-locally-made-electric-vehicles>. [2016, April 5].
- Randall, T. (2016, February 25). *Here's How Electric Cars Will Cause the Next Oil Crisis*. Bloomberg New Energy Finance [Online] <https://www.bloomberg.com/features/2016-ev-oil-crisis/>. [2018, June 12].
- Randers, J. (1976). *A Framework for Discussion of Model Conceptualisation*. The 1976 International Conference on System Dynamics , 414-452. Norway: System Dynamics Society.
- Randers, J. (1980). *Guidelines for Model Conceptualization*. Elements of the System Dynamics Method. Portland: OR: Productivity Press.
- Raymond, C. (2017, August 15). *Public charging stations: Can South Africa support electric cars?* Wheels24 [Online] [http://www.wheels24.co.za/News/Gear\\_and\\_Tech/public-charging-stations-can-south-africa-support-electric-cars-20170815](http://www.wheels24.co.za/News/Gear_and_Tech/public-charging-stations-can-south-africa-support-electric-cars-20170815). [201, January 31].
- Reichmuth, D., & Goldman, J. (2017, August). *Accelerating US Leadership in Electric Vehicles*. Union of Concerned Scientists [Online] [https://www.ucsusa.org/sites/default/files/attach/2017/09/cv-factsheets-ev-incentives.pdf?\\_ga=2.108452610.1630188791.1517413160-1434713090.1436805699](https://www.ucsusa.org/sites/default/files/attach/2017/09/cv-factsheets-ev-incentives.pdf?_ga=2.108452610.1630188791.1517413160-1434713090.1436805699). [2018, May 23].
- Reyneke, M., Sorokáčová, A., & Pitt, L. (2012). *Managing brands in times of economic downturn: How do luxury brands fare?* Journal of Brand Management, 19(6), 457-466.
- Rezvani, Z., Jansson, J., & Bodin, J. (2015). *Advances in consumer electric vehicle adoption research: A review and research agenda*. Transportation Research Part D, 34, 122-136. Elsevier.
- Richardson, G. (1991). *System Dynamics: Simulation for Policy Analysis from a Feedback Perspective*. In P. A. Fishwick, & P. A. Luker (Eds.), *Advances in Simulation* (pp. 144-169). New York: Springer.
- Richardson, G. P., & Pugh III, A. L. (1989). *Introduction to System Dynamics Modelling*. United States of America: Pegasus.
- Riley, G. (2015). *South Africa - Economic Growth and Development*. tutor2u [Online] <https://www.tutor2u.net/economics/reference/south-africa-economic-growth-and-development>. [2018, February 6].
- Roberts, N. (1983). *Introduction to system dynamics modelling*. 562. Portland, Oregon: Productivity Press.
- Rodrigue, J.-P., Comtois, C., & Slack, B. (2017). *The Geography of Transport Systems* (Vol. 4th ). Abingdon: Taylor & Francis.
- Rostow, W. W. (1960). *The Five Stages of Growth*. In *The Stages of Economic Growth: A Non-Communist Manifesto* (pp. 4-16). Cambridge University Press.
- Rubin, J. (2006). *Transportation and Land-Use Change*. In K. J. Boyle, *Economics of Rural Land-Use Change* (p. 14). Routledge: Taylor & Francis Group.



- Ruch, W. (2017). *StatsSA - P03102014 Living Conditions of Households in South Africa 2014/15*. Stats SA. Pretoria: StatsSA.
- SA Government. (2010, November). *The New Growth Plan*. South African Government [Online] <http://www.economic.gov.za/communications/publications/new-growth-path-series/download>. [2018, May 17].
- SA Government. (2012, August 15). *National Development Plan 2030*. South African Government [Online] [https://www.gov.za/sites/default/files/NDP-2030-Our-future-make-it-work\\_r.pdf](https://www.gov.za/sites/default/files/NDP-2030-Our-future-make-it-work_r.pdf). [2018, May 18].
- SAIRR. (2012). *South Africa Survey 2012*. Johannesburg, South Africa.
- SAIRR. (2013, January 24). *South Africa 'two-thirds urbanised'*. South Africa Info [Online] <http://www.southafrica.info/news/urbanisation-240113.htm>. [2016, June 20].
- South African MI. (2015). *Number of vehicles registered per province as per end January 2017*. South African Market Insights [Online] <https://www.southafricanmi.com/blog-21feb2017.html>. [2017, October 31].
- South African MI. (2017, November 6). *SA vs World*. South African Market Insights [Online] <https://www.southafricanmi.com/sa-vs-the-world.html>. [2018, February 6].
- Sanderson, H. (2017, July 7). *Electric car growth sparks environmental concerns*. Financial Times [Online] <https://www.ft.com/content/8342ec6c-5fde-11e7-91a7-502f7ee26895>. [2018, February 6].
- Santini, D. J. (2011). *Electric Vehicle Waves of History: Lessons Learned about Market Deployment of Electric Vehicles*. Electric Vehicles – The Benefits and Barriers. InTech.
- SARB. (2011, June 15). *Time series data*. SARB. Retrieved 15 June 2011.
- SARB. (2012, December). *Full Quarterly Bulletin No 266*. SARB [Online] [http://www.durban.gov.za/City\\_Services/Economic\\_Development/PSIR/SARB%20Quarterly%20Bulletin/SARB%20Quarterly%20Bulletin-December%202012.pdf](http://www.durban.gov.za/City_Services/Economic_Development/PSIR/SARB%20Quarterly%20Bulletin/SARB%20Quarterly%20Bulletin-December%202012.pdf). [2016, 5 June].
- Sargent, R. J. (2013, February). *Verification and validation of simulation models*. Journal of Simulation, 7(12), 12-24.
- Schlesinger, S. (1979). *Terminology for model credibility*. Simulation, 32(3), 103-104.
- Schoemaker, P. H. (1995). *Scenario Planning: a Tool for Strategic Thinking*. Sloan Management Review, 36, 25-40.
- Schools, S. T. (2003). *Tips for Stock/Flow Maps*. Waters Foundation with Catalina Foothills School District.
- Schor, J. B. (2011, October). *The Overspent American: Why We Want What We Dont Need*. St. Margaret Mary Parish [Online] [http://www.smpm.com/services/peace\\_justice\\_docs/Overspent%20American%20-%20Why%20we%20want%20what%20we%20don't%20need.pdf](http://www.smpm.com/services/peace_justice_docs/Overspent%20American%20-%20Why%20we%20want%20what%20we%20don't%20need.pdf). [2018, June 8].
- Schwabinger, M. (2006). *System Dynamics and the Evolution of the Systems Movement*. Systems Research and Behavioral Science, Wiley Interscience, 583-594. John Wiley & Sons Ltd.
- Scott, R. J., Cavana, R. Y., & Cameron, D. (2015). *Interpersonal Success Factors for Strategy Implementation: A Case Study Using Group Model Building*. Journal of the Operational Research Society, 66(6), 1023-1034.

- SD Society. (2016). *Core System Dynamics Software*. (Wordpress and Atahualpa). System Dynamics Society [Online] <http://tools.systemdynamics.org/core-sd-software/>. [2018, April 14].
- SEAI. (2017). *Electric Vehicle Roadmap: 2011-2050*. Ireland: Sustainable Energy Authority of Ireland.
- Sebitosi, A. B., & Pillay, P. (2008). *Grappling with a half-hearted policy: the case of renewable energy and the environment in South Africa*. *Energy Policy*, 36, 2513-2516.
- Senge, P. (1990). *The Fifth Discipline*. Currency Doubleday.
- Seymore, R., Inglesi-Lotz, R., & Blignaut, J. (2014, June). *A greenhouse gas emissions inventory for South Africa: A comparative analysis*. *Renewable and Sustainable Energy Reviews*, 34, 371-379.
- SFSA. (2017, December). *CSIR Electric Vehicles Exhibition*. SFSA [Online] <http://www.sfsa.co.za/council-of-scientific-and-industrial-research/>. [2018, January 30].
- Shamwari Game Reserve. (2015, March 23). *Conserving Shamwari Game Reserve*. ETB Travel News [Online] <http://india.etbtravelnews.global/245988/conserving-shamwari-game-reserve/>. [2018, May 22].
- Shende, V. (2014, February). *Analysis of Research in Consumer Behavior of Automobile Passenger Car Customer*. *International Journal of Scientific and Research Publications*, 4(2).
- Shmueli, G. (2010). *To Explain or to Predict?* *Statistical Science*, 25(3), 289-310.
- ShowMe SA;. (2008). *Maps of South Africa*. Show Me South Africa [Online] <https://showme.co.za/facts-about-south-africa/the-maps-of-south-africa/>. [2018, May 24].
- Shukla, P. R., Dhar, S., Pathak, M., & Bhaskar, K. (2015). *Electric Vehicle Scenarios and a Roadmap for India*. New Delhi: Magnum Custom Publishing.
- Sierzchula, W., Bakker, S., Maat, K., & Van Wee, B. (2014, May). *The influence of financial incentives and other socio-economic factors on electric vehicle adoption*. *Energy Policy*, 68, 183-194.
- Silverstein, M. J., Fiske, N., & Butman, J. (2003). *Trading Up: Why Consumers Want New Luxury Goods--and How Companies Create Them*. New York, United States: Penquin Group.
- Slowik, P., Pavlenko, N., & Lutsey, N. (2016, October). *Assessment of Next Generation Electric Vehicle Technologies White Paper*. The International Council on Clean Transportation [Online] [https://www.theicct.org/sites/default/files/publications/Next%20Gen%20EV%20Tech\\_white-paper\\_ICCT\\_31102016.pdf](https://www.theicct.org/sites/default/files/publications/Next%20Gen%20EV%20Tech_white-paper_ICCT_31102016.pdf). [2018, May 23].
- Smart, J., Francfort, J., Karner, D., Kirkpatrick, M., & White, S. (2009, May). *U.S. Department of Energy – Advanced Vehicle Testing Activity: Plug-in Hybrid Electric Vehicle Testing and Demonstration Activities*. *World Electric Vehicle Journal*, 3, 482-493.
- Smit, P. C., Dams, D. J., Mostert, J. W., Oosthuizen, A. G., Van der Vyver, T. C., & Van Gass, W. (1996). *Economics: A South African Perspective* (Vol. 1st Edition). South Africa: Juta and Company (Pty) Ltd.
- Smith, C. (2016, August). *Tshwane beats Jozi, CT in highest per capita personal income*. FIN24 [Online] <https://www.fin24.com/Economy/tshwane-beats-jozi-ct-in-highest-per-capita-personal-income-20160808>. [2017, November 21].
- Smith, R. (2011, August 31). *The Environmental Sustainability of Paper*. *Graduate Studies Journal of Organizational Dynamics*, 1(1).



- Snyman, C. (2017, December). *Electrifying Mobility*. (S. A. Institute, Ed.). EE Publishers [Online] <http://www.ee.co.za/wp-content/uploads/2017/12/Carel-Snyman-SANEDI-Electrifying-mobility.pdf>. [2018, January 26].
- SOE review. (2016, November 22). *Transport is essential to grow the economy*. SOE Review [Online] <http://www.soereview.co.za/transport-is-essential-to-grow-the-economy/>. [2018, February 9].
- South African Government. (2015). *The National Development Plan 2030, Our Future - Make it Work*. National Planning Commission, Department of the Presidency. National Planning Commission.
- South African MI. (2017). *SA by numbers*. South African Market Insights [Online] <https://www.southafricanmi.com/sa-by-numbers.html>. [2018, May 25].
- South African MI. (2015). *South Africa's Economic Structure*. South African Market Insight [Online] <https://www.southafricanmi.com/south-africas-economic-structure.html>. [2018, January 23].
- Spector, J. (2017, August 17). *Study: We're Still Underestimating Battery Cost Improvements*. Green Tech Media [Online] <https://www.greentechmedia.com/articles/read/were-still-underestimating-cost-improvements-for-batteries#gs.0sAGRLE>. [2018, February 21,].
- Stadler, M., Marnay, C., Sharma, R., Mendes, G., & Kloess, M. (2011, September). *Modeling Electric Vehicle Benefits Connected to Smart Grids*. 7th IEEE Vehicle Power and Propulsion Conference. Chicago.
- Staffwriter. (2016, September 20). *South Africans spend more of their income on petrol than any other country*. BusinessTech [Online] <https://businesstech.co.za/news/energy/137397/south-africans-spend-more-of-their-income-on-petrol-than-any-other-country/>. [2017, February 9].
- Statista. (2017, June). *Number of electric vehicles in the world 2012-2016*. Statista: The Statistics Portal [Online] <https://www.statista.com/statistics/270603/worldwide-number-of-hybrid-and-electric-vehicles-since-2009/>. [2018, February 2].
- Statista. (2018). *U.S. vehicles - projected scrappage rate 2017-2019*. Statista [Online] <https://www.statista.com/statistics/738684/us-vehicle-scrappage-rate/>. [2018, June 5].
- Stats SA. (2012, October). *General Household Survey, 2008-15 data, Census 2011*. Statistics SA.
- Stats SA. (2016, December). *Motor Trade Sales P6343*. Statistics SA.
- Stats SA. (2016, August 25). *P0302 - Mid-year population estimates, 2016*. Statistics SA [Online] <http://www.statssa.gov.za/publications/P0302/P03022016.pdf>. [2018, June 3].
- Stats SA. (2017). *General Household Survey 2016*. Statistical release P0318, Statistics SA.
- Stats SA. (2017, March 7). *P0441 - Gross Domestic Product (GDP), 4th Quarter 2016*. Statistics SA [Online] [http://www.statssa.gov.za/publications/P0441/GDP\\_P0441\\_Annual\\_Quarter\\_and\\_Regional\\_Revisions\\_tables\\_Q4\\_2016.xls](http://www.statssa.gov.za/publications/P0441/GDP_P0441_Annual_Quarter_and_Regional_Revisions_tables_Q4_2016.xls). [2018, June 3].
- Stats SA. (2018, March 6). *Gross Domestic Product, 4th Quarter 2017*. Stats SA [Online] [http://www.statssa.gov.za/?page\\_id=1854&PPN=P0441&SCH=6985](http://www.statssa.gov.za/?page_id=1854&PPN=P0441&SCH=6985). [2018, May 23].
- StatsSA. (2007, September). *Labour Force Survey P0210*. Pretoria, South Africa: Stats SA.
- StatsSA. (2013). *Statistics South Africa*. Stats SA [Online] <http://www.statssa.gov.za/>. [2016, April 4].
- StatsSA. (2015, May). *General Household Survey P0318*. Pretoria, South Africa: Stats SA.

- StatsSA. (2017, January). *Living Conditions Survey 2014/15 P0310*. Stats SA [Online] <http://www.statssa.gov.za/publications/P0310/P03102014.pdf>. [2018, March 27].
- StatsSA. (2017, March). *Statistical Release P0441*. Stats SA [Online] <http://www.statssa.gov.za/publications/P0441/P04414thQuarter2016.pdf>. [2018, March 16].
- StatsSA. (2017, April). *Stats Biz*. StatsSA [Online] <http://www.statssa.gov.za/wp-content/uploads/2017/05/StatsBizApril2017.pdf>. [2017, December 12].
- Sterman, J. D. (1984, Winter). *Appropriate summary statistics for evaluating the historical fit of system dynamics models*. *Dynamics*, 10(2), 51-66.
- Sterman, J. D. (2000). *Business Dynamics: Systems Thinking and Modelling for a Complex World*. McGraw-Hill.
- Sterman, J. D., Richardson, G. P., & Davidsen, P. (1987, May). *Modeling the Estimation of Petroleum Resources in the United States*.
- Styczynski, Z., Stotzer, M., Muller, G., & Komarnicki, P. (2012). *Challenges and barriers of integrating e-cars into a grid with high amount of renewable generation*.
- Sudhansu. (2017, November 11). *What is the Difference between Electric cars vs. IC Engine Cars*. The Indian Society [Online] <http://theindiansociety.org/electric-cars-2/>. [2018, February 1].
- Suleman, M., Gaylard, M., Tshaka, S., & Snyman, C. (2015). *South African Cities Green Transport Programme: Accelerating the Transition to Green Transport*. SANEDI, SA Cities Network, Linkd, Department of Environmental Affairs. Midrand, South Africa: SA Green Fund, Development Bank of SA.
- Sullivan, J., Salmeen, I., & Simon, C. (2009). *PHEV Marketplace Penetration: An Agent Based Simulation*. Working Paper of the University of Michigan Research Institute.
- Sun, I. Y. (2007). *Gini Coefficient*. Blackwell Encyclopaedia of Sociology. (G. Ritzer, Ed.)
- Sustainable Energy Authority of Ireland. (2010, August 27). *A Guide to Electric Vehicles*. Donegal County Development Board [Online] [http://www.donegalcdb.ie/media/wwwdonegalcdbie/content/greeneconomy/Electric\\_Vehicles-1.pdf](http://www.donegalcdb.ie/media/wwwdonegalcdbie/content/greeneconomy/Electric_Vehicles-1.pdf). [2018, May 22].
- Sustainable Energy Authority of Ireland. (2010, August). *A Guide to Electric Vehicles*. Dublin: Sustainable Energy Authority of Ireland.
- Swart, G. (2015). *Innovation Lessons Learned from the Joule EV Development*. In D. L. Pretorius (Ed.), 24th International Association for Management of Technology Conference Proceedings. Cape Town: International Association of Management of Technology.
- Sysdea. (2016). *Modern online modeling software*. Retrieved from Sysdea: <https://sysdea.com/>
- Anylogic. (2016). *System Dynamic Simulation, Anylogic*. Anylogic: Multimethod Simulation Software [Online] <http://www.anylogic.com/system-dynamics>. [2016, April 14].
- System Dynamics Society. (2016, July-December). *In Memorium Jay W. Forrester 1918-2016*. *System Dynamics Review*, 32(3-4), 185-186.
- Systems Thinker. (2011, February). *Building Blocks: Guidelines for Causal Loop Diagrams*. 22(1). Pegasus.

- Tainter, J. A. (2011, June). *Energy, complexity, and sustainability: a historical perspective*. Environmental Innovation and Societal Transitions, 1(1), 89-95.
- Takahashi, Y. (2003). *Translation from Natural Language to Stock Flow Diagrams*. Senshu Research Abroad Program. Japan: School of Commerce, Senshu University.
- Tesla. 2016. *About Tesla*. [Online] <https://www.teslamotors.com/about>. [2016, June 11].
- Testa, G. (2017). *A comparative, simulation supported study on the diffusion of battery electric vehicles in Norway and Sweden*. University of Bergen & Radboud University, Oslo.
- Teufel, F., Miller, M., Genoese, M., & Fichtner, W. (2013, April). *Review of System Dynamics models for electricity market simulations. Working Paper Series In Production And Energy*. Germany: Karlsruhe Institute of Technology.
- Thackeray, M. (2011, June 20). *Twenty Golden Years of Battery R&D at CSIR, 1974–1994*. South African Journal of Chemistry, 64(1), 61-66.
- The Economist. (2017, September). *An infrastructure for charging electric vehicles takes shape*. The Economist [Online] <https://www.economist.com/news/business/21728671-reliable-network-should-not-prove-insurmountable-roadblock-infrastructure-charging>. [2017, December 4].
- Todd, J. (2013). *Analysis of the Electric Vehicle Industry. Creating The Clean Energy Economy*. Washington: International Economic Development Council.
- Tongwane, M. (2013). *Transport Sector Greenhouse Gas Inventory for South Africa for the base year 2009*. University of Witwatersrand, Faculty of Science. Johannesburg: University of Witwatersrand.
- Tourism, D. (1999). *Greenhouse Gas Emissions Inventory*. Pretoria.
- Treasury. (2016, March). *Estimates of Provincial Revenue and Expenditure 2015/16*. Treasury [Online] <http://www.treasury.gov.za/documents/provincial%20budget/2015/4.%20Estimates%20of%20Prov%20Rev%20and%20Exp/NW/1.%20Budget%20Overview/NW%20-%20EPRE%20-%20Budget%20Overview.pdf>. [2018, March 27].
- Treasury. (2017, April). *Estimates of Provincial Revenue and Expenditure for the Free State*. Treasury [Online] <http://www.treasury.gov.za/documents/provincial%20budget/2017/4.%20Estimates%20of%20Prov%20Rev%20and%20Exp/FS/FS%20-%20EPRE%20-%20Full%20Document.pdf>. [2018, June 14].
- True World. (2015, December). *TRUE - Temporal Reasoning Universal Elaboration: System Dynamics - Multibody Dynamics Simulation (MDS) - Procedural Animation*. True World [Online] <http://true-world.com/htm/en/index.html>. [2018, June 14].
- Turan, O., & Yucel, G. (2014). *Analysing Electric Vehicle Diffusion Scenarios for Istanbul*. Proceedings of the System Dynamics Conference. System Dynamics Society.
- Turbospout. (2008, October 1). *SA's electric car joule: official pics*. Urban Sprout [Online] [https://urbansprout.co.za/sas\\_electric\\_car\\_joule\\_official\\_pics](https://urbansprout.co.za/sas_electric_car_joule_official_pics). [2018, February 1].
- Turok, I. (2012, October). *Urbanisation and Development in South Africa: Economic Imperatives, Spatial Distortions and Strategic Responses*. Urbanization And Emerging Population Issues Working Paper 8. London: International Institute for Environment and Development (IIED).

- Tziafetas, G. N. (1989). *A Formula for the Gini Coefficient and its Decomposition*. *Biometrical Journal*, 31(8), 961-967.
- Umpleby, S. A., & Dent, E. B. (1999). *The Origins and Purposes of Several Traditions in Systems Theory and Cybernetics*. *Cybernetics and Systems: An International Journal*, 79-103.
- U.S Government Publishing Office. (2011). *United States Code, 2006 Edition, Supplement 5, Title 15 - Commerce and Trade*. Government Publishing Office [Online] <https://www.gpo.gov/fdsys/granule/USCODE-2011-title15/USCODE-2011-title15-chap52-sec2502>. [2018, May 22].
- U.S. Department of Energy. (2014, December). *Evaluating EV Charging Impacts and Customer Charging Behaviours, Smart Grid Investment Grant Program*. U.S. Department of Energy.
- uYilo. (n.d.). *Electric game viewer demonstration*. uYilo [Online] <http://uyilo.org.za/Projects/Electric-game-viewer-demonstration>. [2018, February 1].
- uYilo. (n.d.). *Home*. uYilo e-Mobility Programme [Online] <http://uyilo.org.za/>. [2018, January 30].
- Van de Ven, P. (2015, February). *New Standards for Compiling National Accounts: Whats the impact on GDP and other Macro-economic Indicators*. OECD [Online] <http://www.oecd.org/sdd/na/new-standards-for-compiling-national-accounts-SNA2008-OECD2015.pdf>. [2018, March 15].
- Van Der Merwe, A. (2014). *Eskom Generation Plan*. Johannesburg, South Africa: South Africa.
- Van Heerden, G. (2016). *Assets & Inome 2016*. IRR.
- Van Zyl, G. (2016, July 24). *Why the SA economy needs to grow by at least 5%*. Fin24 [Online] <https://www.fin24.com/Economy/why-the-sa-economy-needs-to-grow-by-at-least-5-20160724>. [2018, February 6].
- Van Zyl, J., Cross, C., & O' Donovan, M. (2008, March). *Overview of the extent and nature of the unbundling of south african households and the implications thereof*.
- Vaneman, W. K., & Triantis, K. (2003). *The dynamic production axioms and system dynamic behaviors: the foundation of future integration*. *Journal of Productivity Analysis*, 19, 93-113.
- Vaudreuil, M. P., Guerin, D. R., Arnold, M. R., & Timms, B. S. (2011, May). *System Dynamics Computer Simulation Modelling to Forecast the Energy Demands for the Montachusett Region under a variety of Simulations and Scenarios*. Montachusett: Worcester Polytech Institute.
- Vennix, J. A. (2000, February). *Group Model Building: Tackling Messy Problems*. *System Dynamics Review*, 15(4), 379-401.
- Ventana Systems. (2015). *Vensim Documentation*. Vensim: Ventana Systems [Online] <http://vensim.com/docs/>. [2016, April 21].
- Venter, C. J., & Mohammed, S. O. (2013, April). *Estimating car ownership and transport energy consumption: a disaggregate study in Nelson Mandela Bay*. *Journal of the South African Institution of Civil Engineering*, 55(1).
- Venter, I. (2017, August). *BMW approaches govt to scrap import duty on electric vehicles*. *Engineering News* [Online] <http://www.engineeringnews.co.za/article/bmw-sa-approaches-govt-to-scrap-import-duty-on-electric-vehicles-2017-08-07>. [2017, December 12].

- Vilchez, J. J., Jochem, P., & Fichtner, W. (2013, November 17-20). *EV Market Development Pathways – An Application of System Dynamics for Policy Simulation*. World Electric Vehicle Journal, 6, 1030-1038.
- Von Bertalanffy, L. (1972, December). *The History and Status of General Systems Theory*. The Academy of Management Journal, 15(4), 407-426.
- Wakefield, E. H. (1994). *History of the Electric Automobile: Battery-Only Powered Cars*. Society of Automotive Engineers Inc. Warrendale, USA.
- Wakeford, J. J. (2013). *Preparing for Peak Oil in South Africa - An Integrated Study*. Stellenbosch, South Africa: Springer Science & Business Media.
- Watanabe, C. (2017, November 28). *Why Battery Cost Could Put the Brakes on Electric Car Sales*. Bloomberg [Online] <https://www.bloomberg.com/news/articles/2017-11-28/electric-cars-need-cheaper-batteries-before-taking-over-the-road>. [2018, May 23].
- Welch, D. (2017, October 3). *Automakers plan electric car blitz even as Tesla burns billions*. The Big Spend Budget 2018 [Online] <http://www.livemint.com/Industry/KrU38T3HGAb2YBPoZjsrIM/Automakers-plan-electric-car-blitz-even-as-Tesla-burns-billi.html>. [2018, January 31].
- Welgemoed, F. (2013, April). *Electric Vehicles 2013: RES/RR/12/34348*. Eskom SOC. Johannesburg, South Africa.
- WesBank. (2017, June 1). *Junk status continues to affect new vehicle sales*. Wesbank [Online] <https://www.wesbank.co.za/wesbankcoza/pressroom/archive/2017/06/01/new-vehicle-sale-commentary/junk-status-continues-to-affect-new-vehicle-sales>. [2018, June 15].
- Whakatutuki, H. (2015). *Projections of Electric Vehicel Fleet Size. Method description for the Draft EDGS 2015*. New Zealand: Ministry of Business, Innovation & Employment.
- Wheels24. (2018, January 16). *Electric vehicles in SA: Uptake of EVs slow but steady*. Wheels24 Motoring News [Online] [https://www.wheels24.co.za/News/Gear\\_and\\_Tech/electric-vehicles-in-sa-uptake-of-evs-slow-but-steady-20180116](https://www.wheels24.co.za/News/Gear_and_Tech/electric-vehicles-in-sa-uptake-of-evs-slow-but-steady-20180116). [2018, May 22].
- Whitman, H. (2016, November). *The Lifecycle Impact of Electric Vehicles*. TriplePundit [Online] <https://www.triplepundit.com/2016/11/lifecycle-impact-electric-vehicles/>. [2017, December 14, ].
- Wilson, L. (2013). *Shades of Green: Electric Cars' Carbon Emissions Around the Globe*. Shrink That Footprint, United Kingdom.
- Winkler, H. (2007, March). *Energy policies for sustainable development in South Africa*. Energy for Sustainable Development, 11(1), 26-34.
- World Bank. (2008). *World Development Indicators*. World Bank.
- World Bank. (2018). *An Incomplete Transition Overcoming the Legacy of Exclusion in South Africa*. World Bank Group.
- World Population Prospects. (2013, June 13). *World Population Prospects: The 2012 Revision (Updated: 13 June 2013)*. South Africa Data Portal [Online] <http://southafrica.opendataforafrica.org/UNWPP2012R/world-population-prospects-the-2012-revision-updated-13-june-2013>. [June 14, 2017].

- Wright, J. G., Bischof-Niemz, T., Calitz, J., Mushwana, C., Van Heerden, R., & Senatla, M. (2017, April 3). *Formal comments on the Integrated Resource Plan (IRP) Update Assumptions, Base Case and Observations 2016*. CSIR [Online] [https://www.csir.co.za/sites/default/files/Documents/20170331CSIR\\_EC\\_DOE.pdf](https://www.csir.co.za/sites/default/files/Documents/20170331CSIR_EC_DOE.pdf). [2018, June 4].
- Wu, Q., Tae Cha, S., & Nielsen, A. H. (2012). *Impact Study of Electric Vehicle Integration on Low Voltage Grids*. CIGRE, no. C6-105.
- Yan, Q., Wang, X., Balezentis, T., & Streimikiene, D. (2018, March 21). *Energy-economy-environment (3E) performance of Chinese regions based on the data envelopment analysis model with mixed assumptions on disposability*. Energy & Environment.
- Yang, W., Zhou, H., & Liu, J. (2015, September 8-11). *Market evolution modeling for electric vehicles based on system dynamics and multi-agents*. Smart Electric Distribution Systems and Technologies (EDST). Vienna.
- Yilmaz, M., & Krein, P. (2013, May). *Review of Battery Charger Topologies, Charging Power Levels, and Infrastructure for Plug-In Electric and Hybrid Vehicle*. IEEE Transactions On Power Electronics, 28(5), 2151-2160.
- Zamalloa, M., Arzuaga, A., & Chan, M. (2012). *Polyphase charging station: Optimized integration of high power EV charging into the distribution grid*.
- Zhang, C., & Qin, C. (2014). *Exploration of the Growing Trend of Electric Vehicles in Beijing with System Dynamics method and Vensim model*. China: System Dynamics Society.
- Zide, S. (2012, November). *An Analysis Of The Demand For New Passenger Vehicles In South Africa (1995-2005)*. North West University.
- Zubaryeva, A., Thiel, C., Barbone, E., & Mercier, A. (2012, November). *Assessing factors for the identification of potential lead markets for electrified vehicles in Europe: expert opinion elicitation*. Technological Forecasting and Social Change, 79(9), 1622-1637.
- записи, К. (2014, April). *Electric powered cars*. Electrical-cars.net [Online] <http://electrical-cars.net/interesting/electric-powered-cars.html>. [2016, June 12].

## Appendix A

### Daily Average Electricity Load per Month (2015)

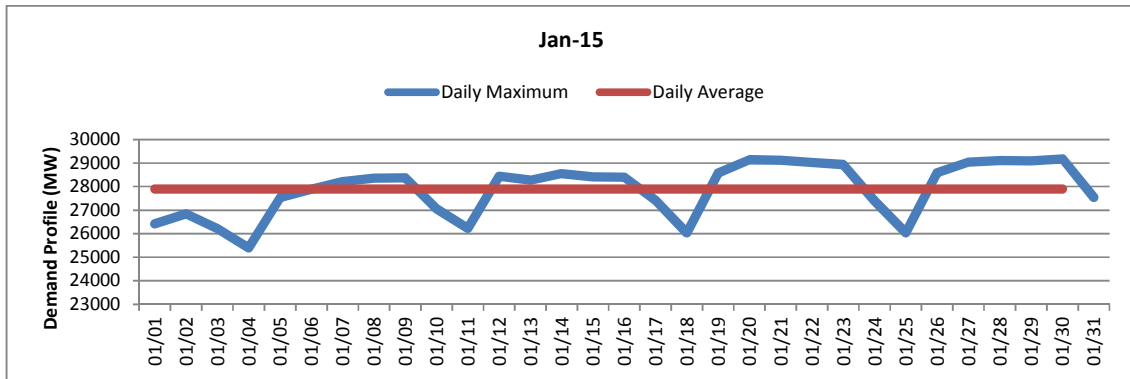

Figure A1: Daily Maximum and Average Electricity Load (MW) January 2015

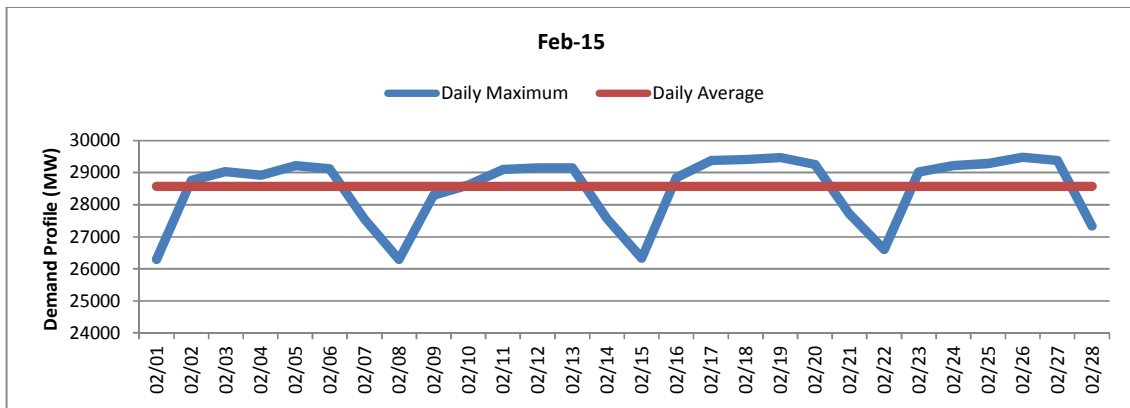

Figure A2: Daily Maximum and Average Electricity Load (MW) February 2015

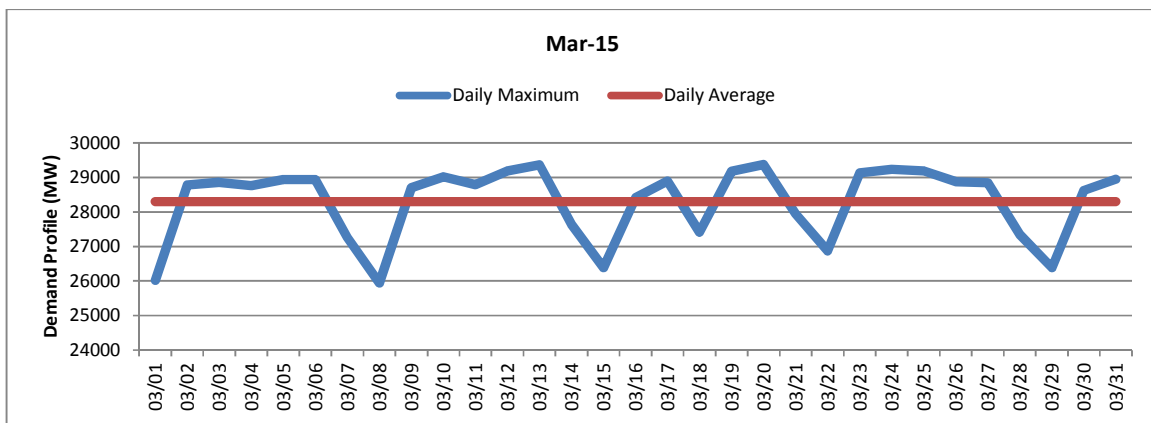

Figure A3: Daily Maximum and Average Electricity Load (MW) March 2015



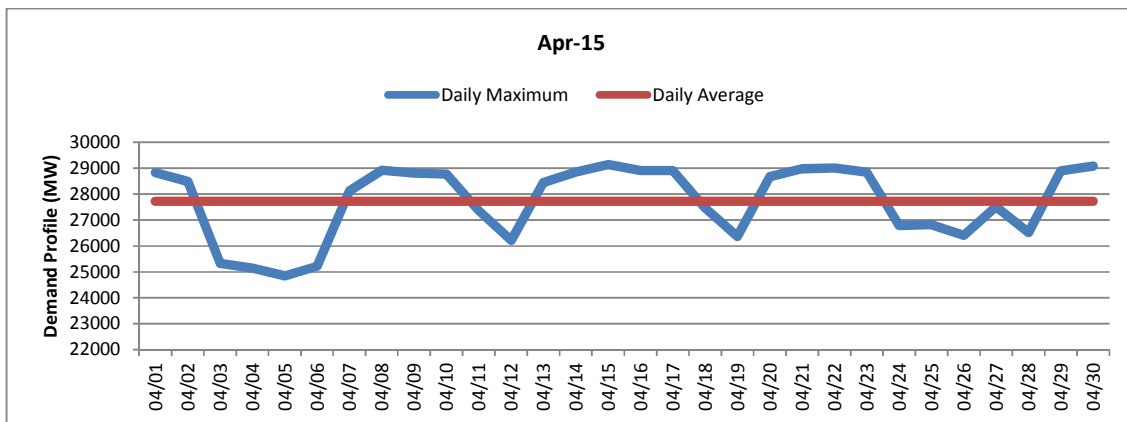

Figure A4: Daily Maximum and Average Electricity Load (MW) April 2015

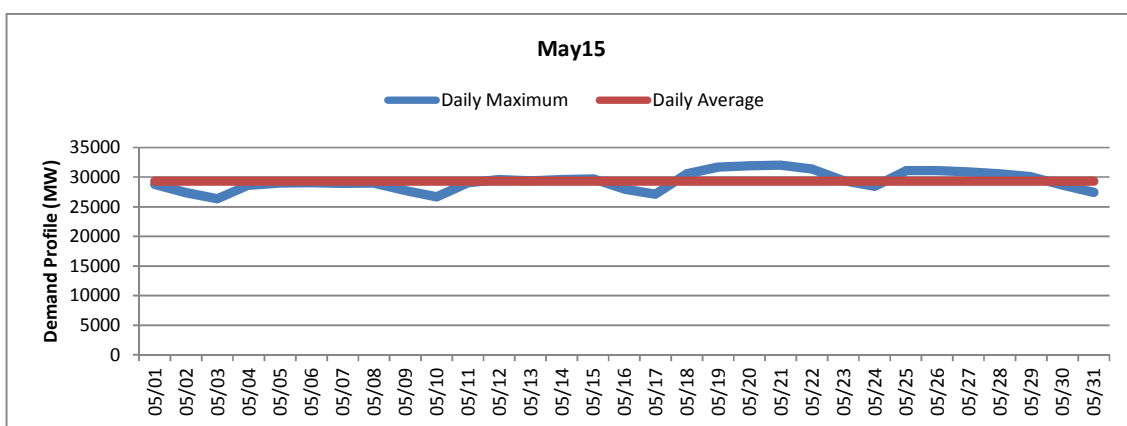

Figure A5: Daily Maximum and Average Electricity Load (MW) May 2015

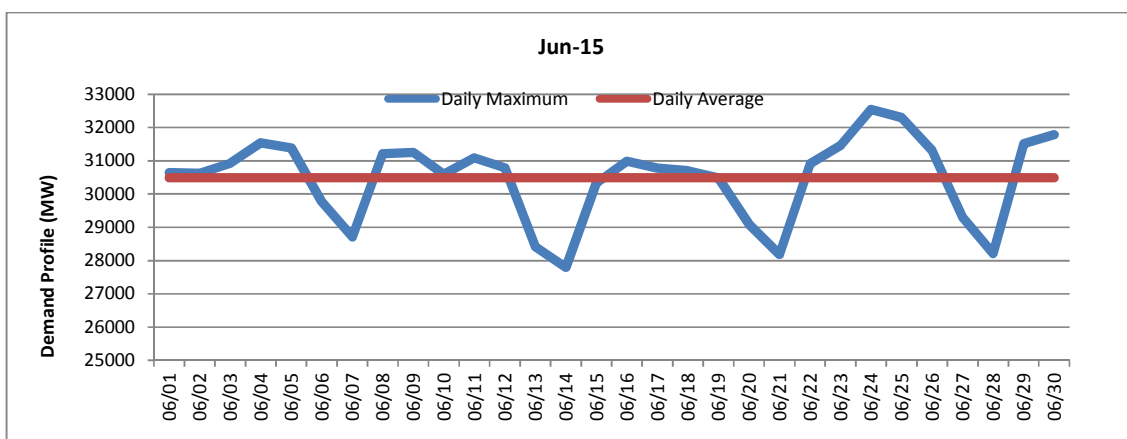

Figure A6: Daily Maximum and Average Electricity Load (MW) June 2015



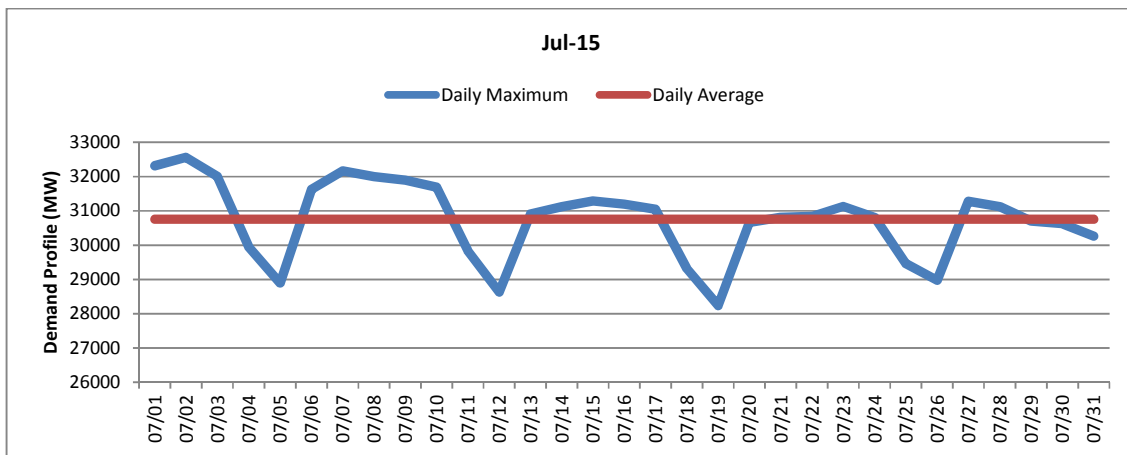

Figure A7: Daily Maximum and Average Electricity Load (MW) July 2015

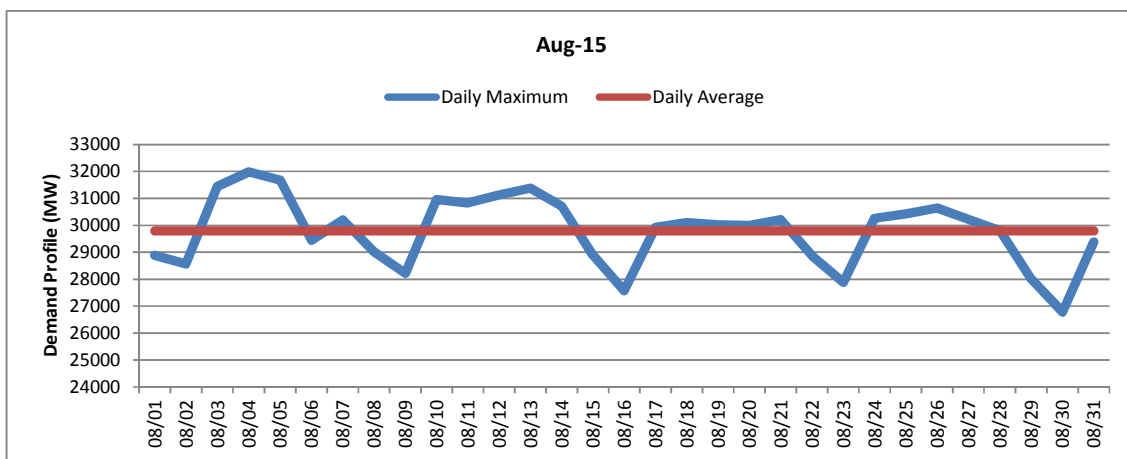

Figure A8: Daily Maximum and Average Electricity Load (MW) August 2015

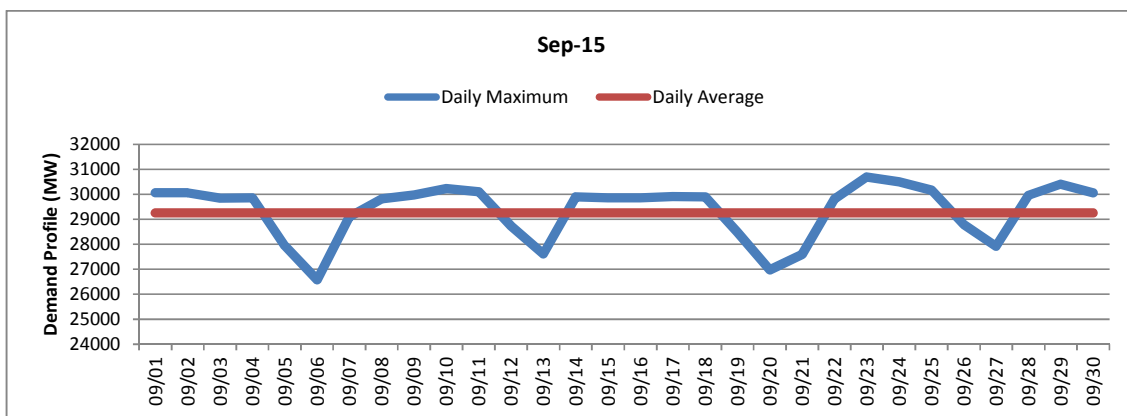

Figure A9: Daily Maximum and Average Electricity Load (MW) September 2015

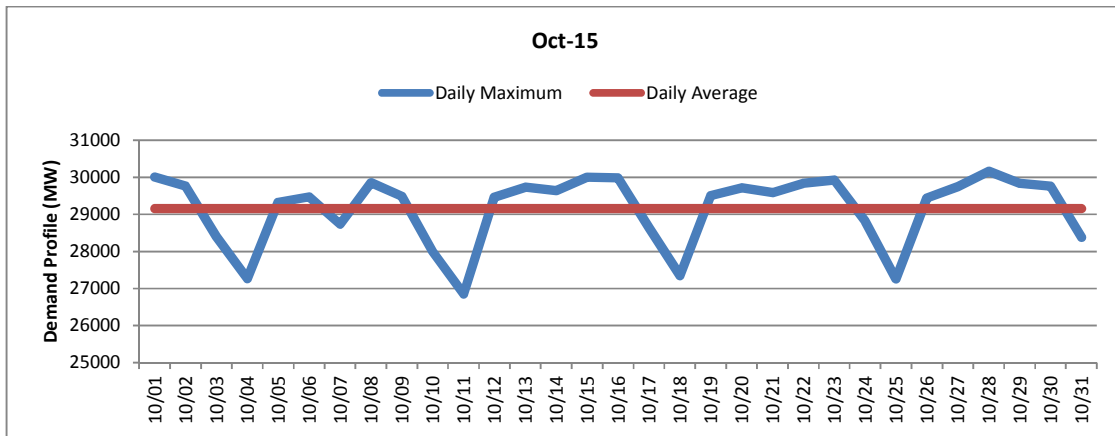

Figure A10: Daily Maximum and Average Electricity Load (MW) October 2015

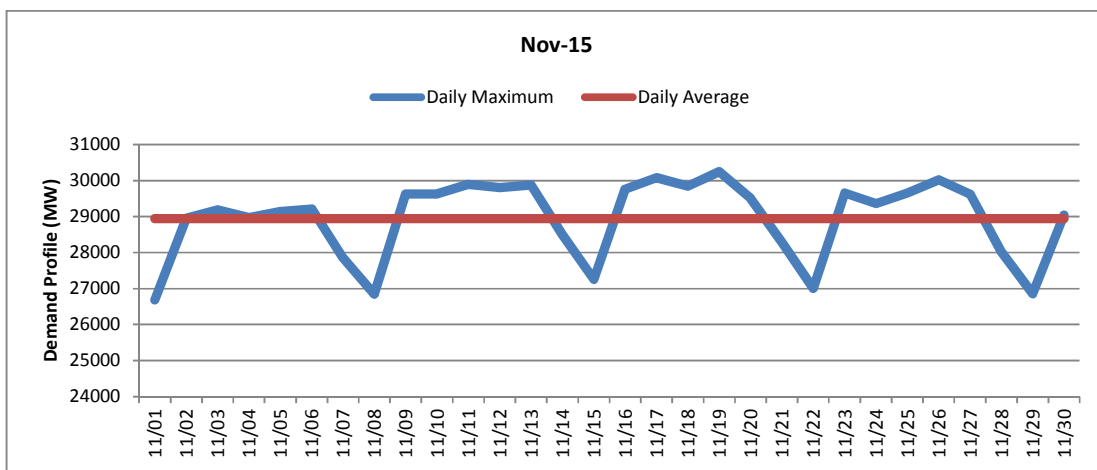

Figure A11: Daily Maximum and Average Electricity Load (MW) November 2015

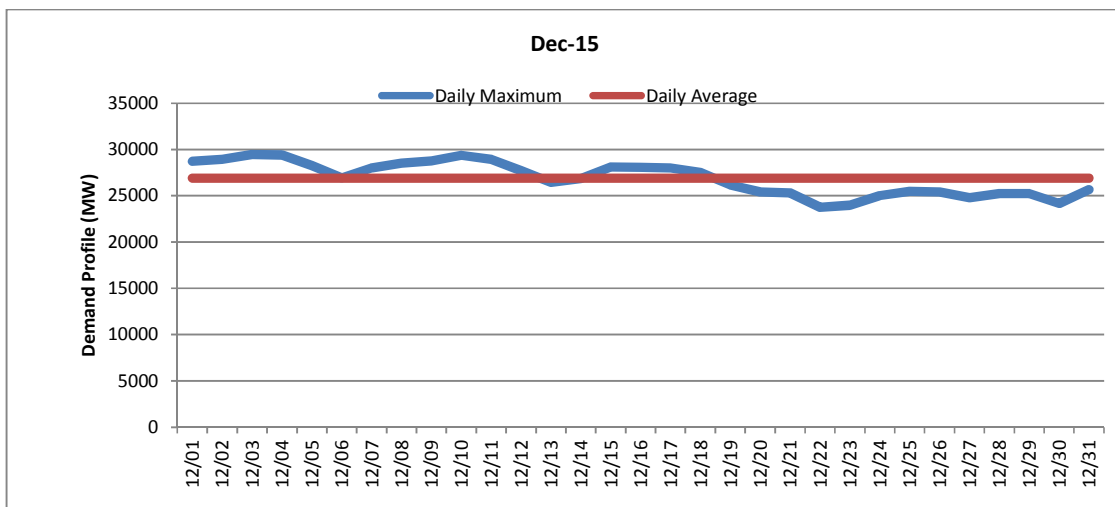

Figure A12: Daily Maximum and Average Electricity Load (MW) December 2015

## Appendix B

### B1: Macro for Data Mining – Count, Sum and Sequence Variables (Distance travelled, Energy used, Charge)

#### Sub SUMVAR()

```
Dim i As Single, j As Single, sumvar1 As Single, dt As Long, count As Long, k As Long,
sumvar2 As Single, sumvar3 As Single
```

```
k = 3
```

```
For k = 3 To 12
```

```
  i = 5
```

```
  count = 5
```

```
  While Worksheets(k).Cells(i, 11) <> ""
```

```
    sumvar1 = Worksheets(k).Cells(i, 8)
```

```
    sumvar2 = Worksheets(k).Cells(i, 9)
```

```
    sumvar3 = Worksheets(k).Cells(i, 5)
```

```
    dt = Worksheets(k).Cells(i, 11)
```

```
    j = i + 1
```

```
  While Worksheets(k).Cells(j, 11) = Worksheets(k).Cells(i, 11) And Worksheets(k).Cells(j,
  11) <> ""
```

```
    sumvar1 = sumvar1 + Worksheets(k).Cells(j, 8)
```

```
    sumvar2 = sumvar2 + Worksheets(k).Cells(j, 9)
```

```
    sumvar3 = sumvar3 + Worksheets(k).Cells(j, 5)
```

```
    j = j + 1
```

```
  Wend
```

```
  Worksheets(k).Cells(i, 15) = sumvar1
```

```
  Worksheets(k).Cells(i, 14) = sumvar2
```

```
  Worksheets(k).Cells(i, 13) = sumvar3
```

```
  Worksheets(k).Cells(count, 16) = dt
```

```
  Worksheets(k).Cells(count, 17) = sumvar1
```

```
  Worksheets(k).Cells(count, 18) = sumvar2
```

```
  Worksheets(k).Cells(count, 19) = sumvar3
```

```
  count = count + 1
```

```
  i = j
```

```
  Wend
```

```
Next k
```

```
End Sub
```

**B2: Macro for Data Mining – Average and sequence hourly data into Columns  
(Distance travelled, Energy used, Charge)**

**Sub AVERAGE1()**

Dim i As Single, j As Single, StartSOC As Single, EndSOC As Single, dt As Long, count As Long, k As Long, averagecount As Integer

k = 3

For k = 3 To 12

i = 5

count = 5

While Worksheets(k).Cells(i, 11) <> ""

    StartSOC = Worksheets(k).Cells(i, 6)

    EndSOC = Worksheets(k).Cells(i, 7)

    dt = Worksheets(k).Cells(i, 11)

    averagecount = 1

    j = i + 1

While Worksheets(k).Cells(j, 11) = Worksheets(k).Cells(i, 11) And Worksheets(k).Cells(j, 11) <> ""

    StartSOC = StartSOC + Worksheets(k).Cells(j, 6)

    EndSOC = EndSOC + Worksheets(k).Cells(j, 7)

    averagecount = averagecount + 1

    j = j + 1

Wend

Worksheets(k).Cells(i, 20) = StartSOC / averagecount

Worksheets(k).Cells(count, 21) = StartSOC / averagecount

Worksheets(k).Cells(i, 22) = EndSOC / averagecount

Worksheets(k).Cells(count, 23) = EndSOC / averagecount

count = count + 1

i = j

Wend

Next k

End Sub

## Appendix C

### Daily Charging and Electricity Consumption BEV profiles

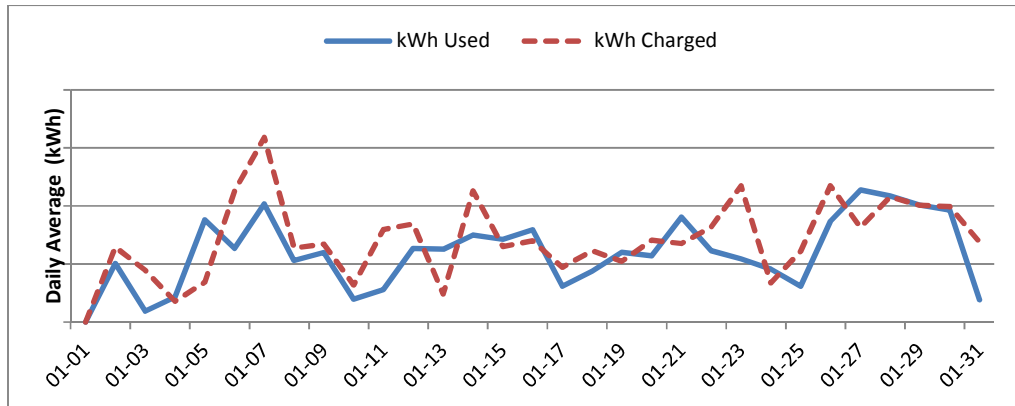

Figure C1: January 2015 BEV Daily Charging and Consumption Profile

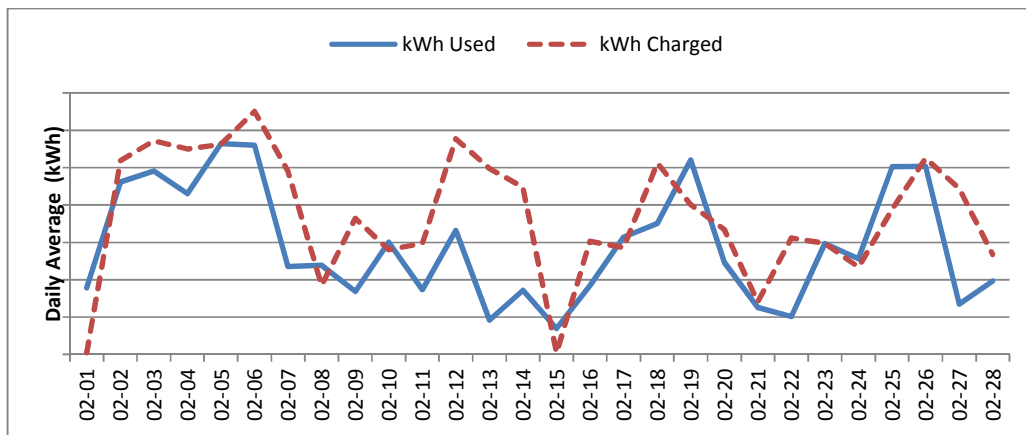

Figure C2: February 2015 BEV Daily Charging and Consumption Profile

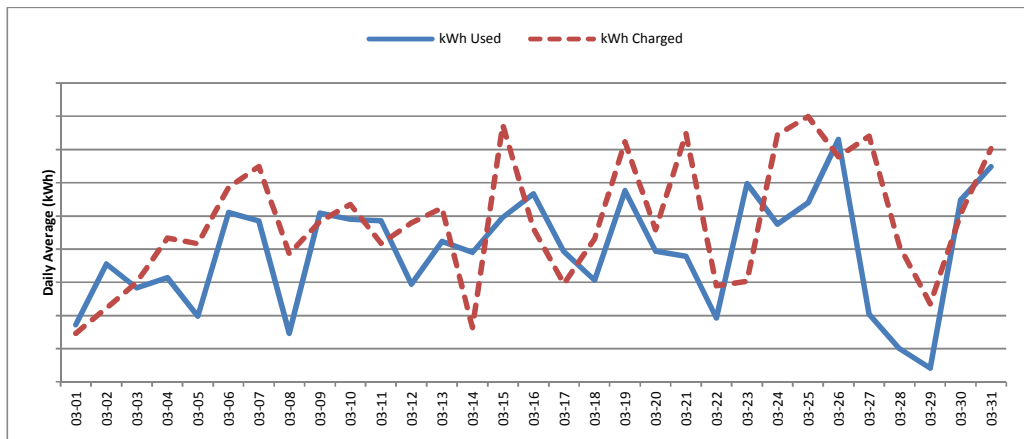
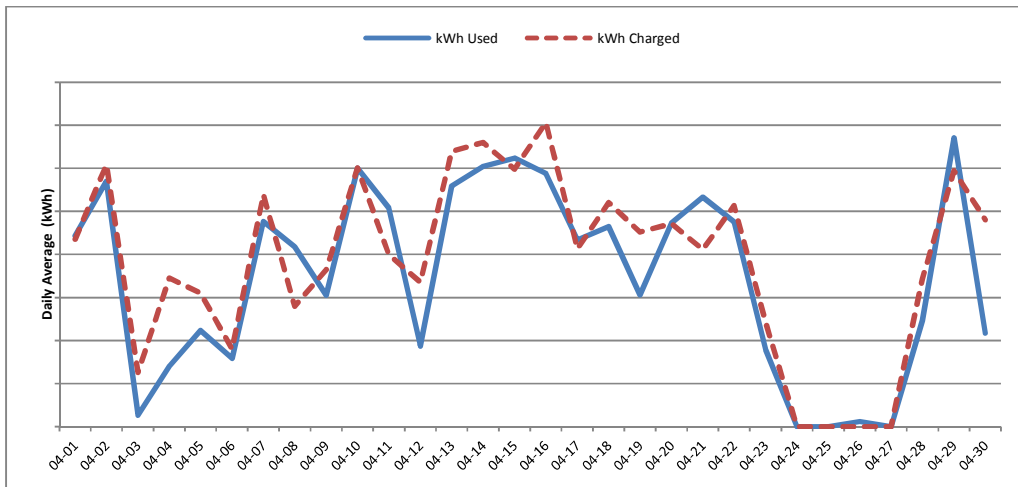
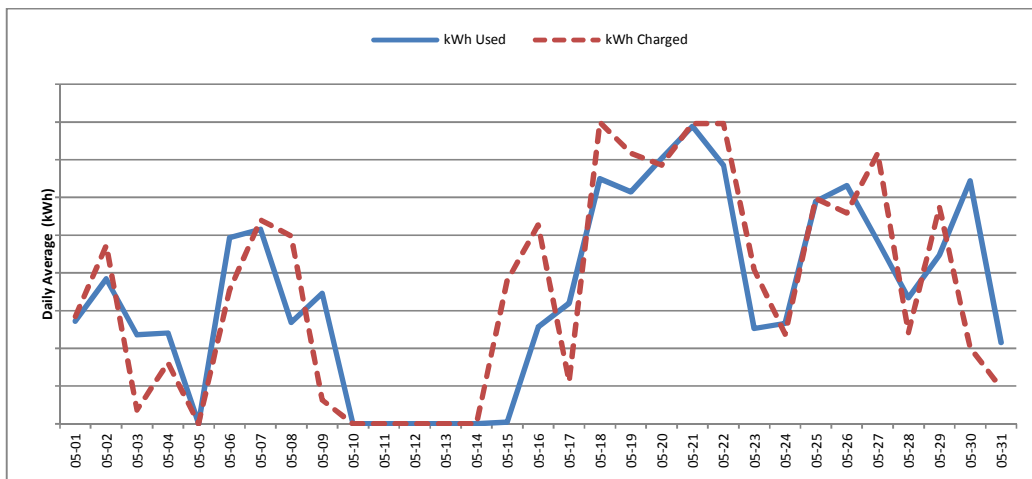

Figure C3: March 2015 BEV Daily Charging and Consumption Profile



**Figure C4: April 2015 BEV Daily Charging and Consumption Profile**



**Figure C5: May 2015 BEV Daily Charging and Consumption Profile**

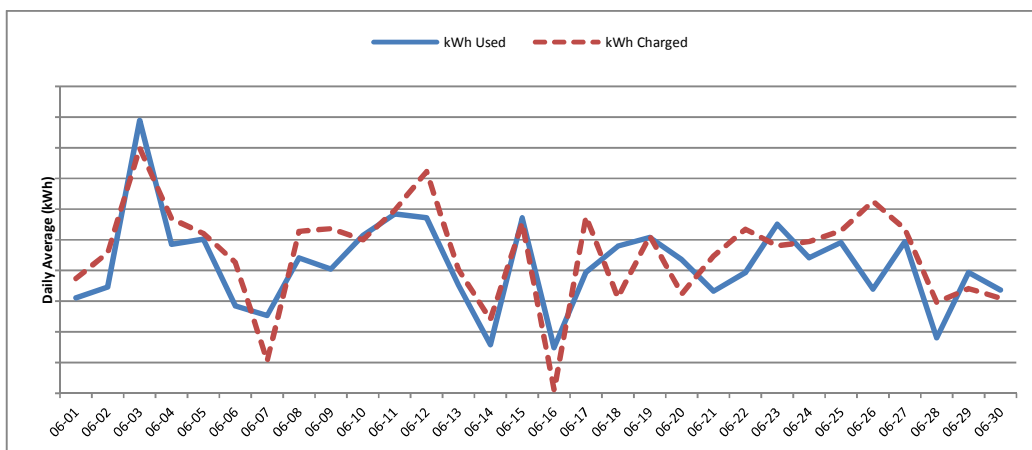

**Figure C6: June 2015 BEV Daily Charging and Consumption Profile**

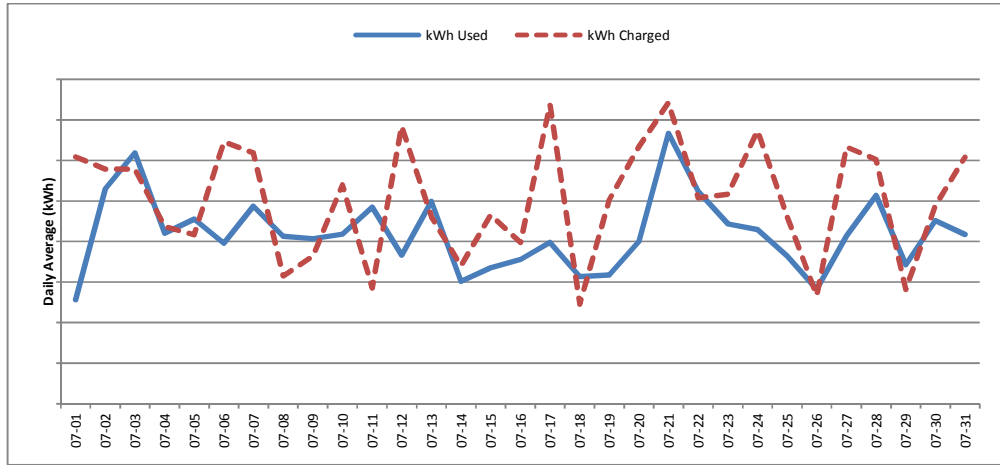

**Figure C7: July 2015 BEV Daily Charging and Consumption Profile**

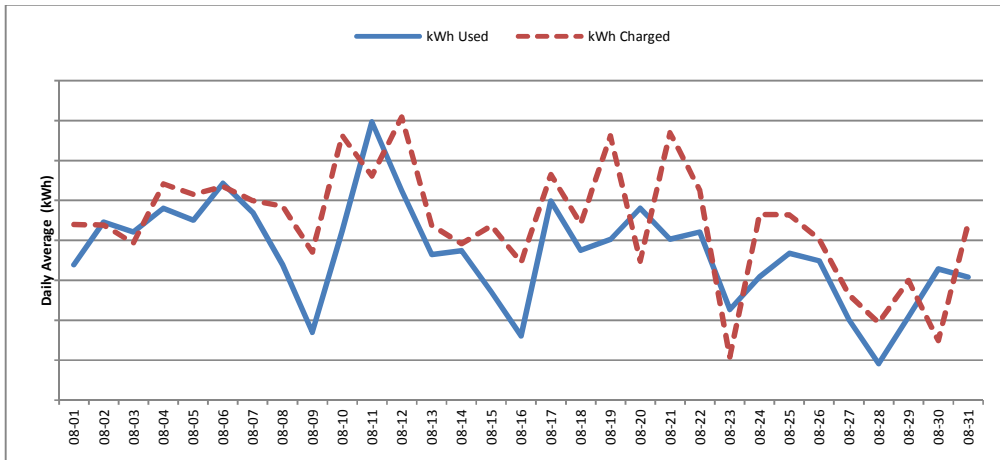

**Figure C8: August 2015 BEV Daily Charging and Consumption Profile**

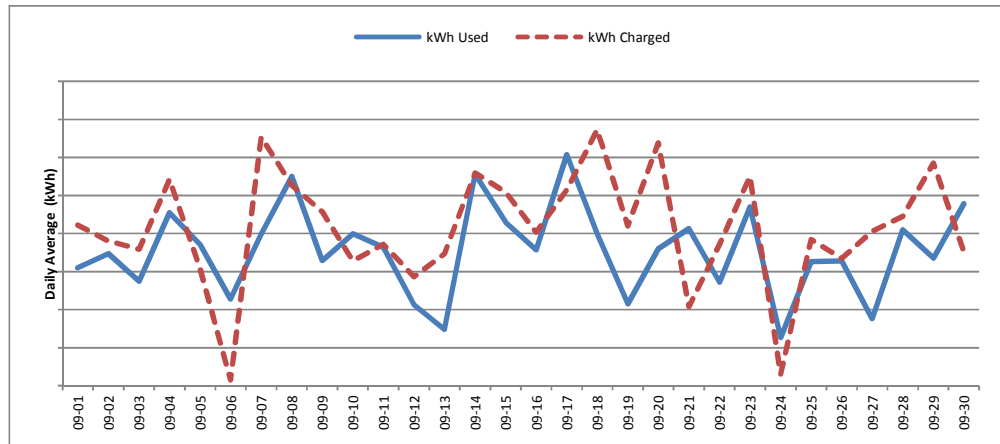

**Figure C9: September 2015 BEV Daily Charging and Consumption Profile**

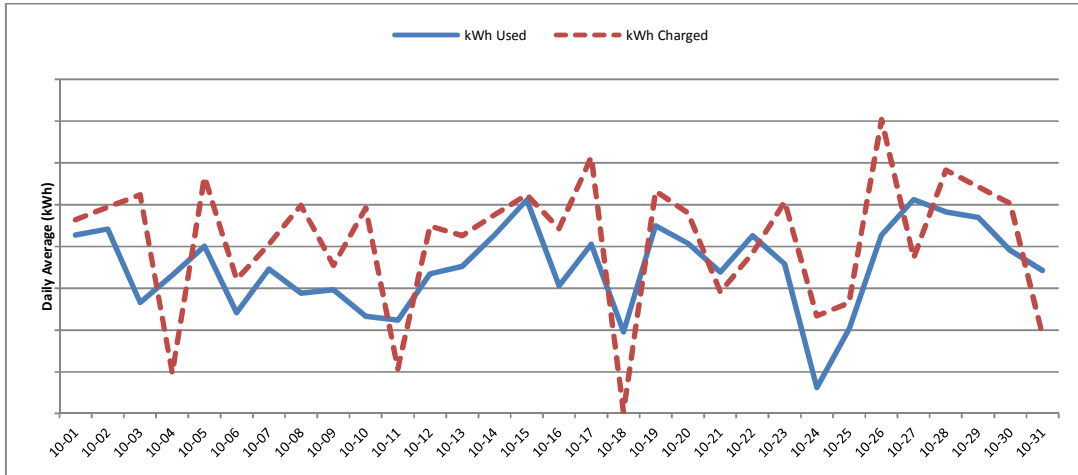

**Figure C10: October 2015 BEV Daily Charging and Consumption Profile**

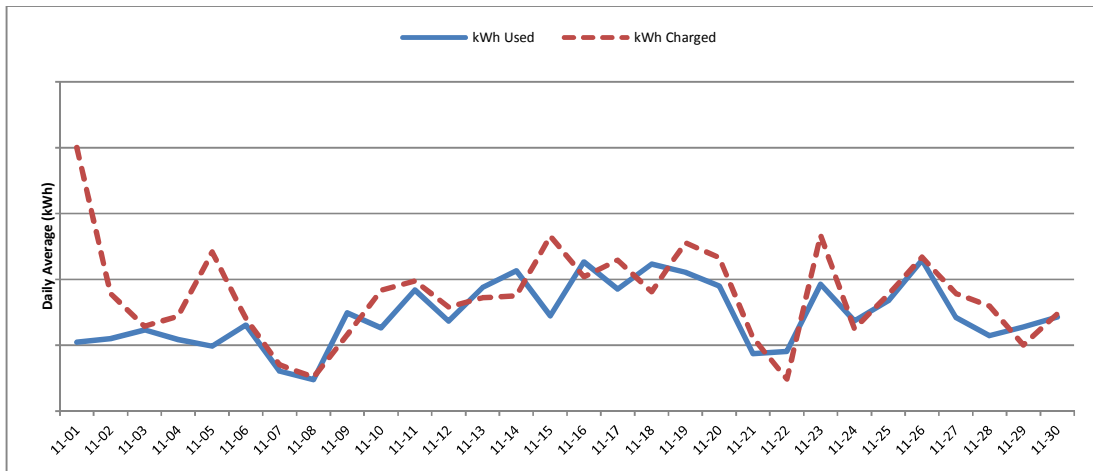

**Figure C11: November 2015 BEV Daily Charging and Consumption Profile**

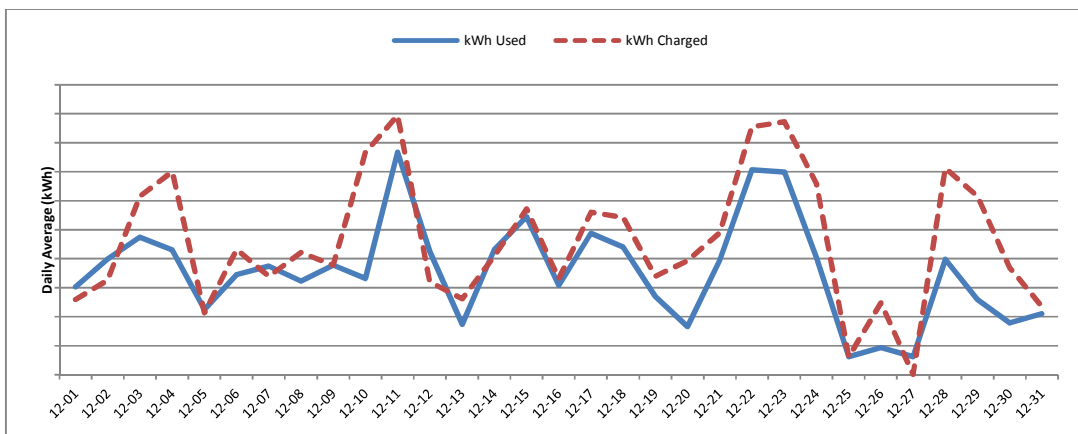

**Figure C12: December 2015 BEV Daily Charging and Consumption Profile**