



Influence of gas discharge parameters on emissions from a dielectric barrier discharge excited argon excimer lamp

Authors:

Peter Baricholo¹
Dumisani J. Hlatywayo¹
Hubertus M. von Bergmann²
Timo Stehmann²
Erich Rohwer²
Mike Collier³

Affiliations:

¹Department of Applied Physics, National University of Science and Technology, Bulawayo, Zimbabwe

²Laser Research Institute, Department of Physics, Stellenbosch University, Stellenbosch, South Africa

³Department of Electronic Engineering, National University of Science and Technology, Bulawayo, Zimbabwe

Correspondence to:
Peter Baricholo

Email:
pbaricholo@yahoo.com

Postal address:
PO Box AC939, Ascot, Bulawayo, Zimbabwe

Dates:
Received: 06 Jan. 2011
Accepted: 20 June 2011
Published: 03 Nov. 2011

How to cite this article:
Baricholo P, Hlatywayo DJ, Von Bergmann HM, Stehmann T, Rohwer E, Collier M. Influence of gas discharge parameters on emissions from a dielectric barrier discharge excited argon excimer lamp. *S Afr J Sci.* 2011;107(11/12), Art. #581, 7 pages. <http://dx.doi.org/10.4102/sajs.v107i11/12.581>

© 2011. The Authors.
Licensee: AOSIS OpenJournals. This work is licensed under the Creative Commons Attribution License.

A dielectric barrier discharge excited neutral argon (Ar I) excimer lamp has been developed and characterised. The aim of this study was to develop an excimer lamp operating at atmospheric pressure that can replace mercury lamps and vacuum equipment used in the sterilisation of medical equipment and in the food industry. The effects of discharge gas pressure, flow rate, excitation frequency and pulse width on the intensity of the Ar I vacuum ultraviolet (VUV) emission at 126 nm and near infrared (NIR) lines at 750.4 nm and 811.5 nm have been investigated. These three lines were chosen as they represent emissions resulting from de-excitation of excimer states that emit energetic photons with an energy of 9.8 eV. We observed that the intensity of the VUV Ar₂* excimer emission at 126 nm increased with increasing gas pressure, but decreased with increasing excitation pulse frequency and pulse width. In contrast, the intensities of the NIR lines decreased with increasing gas pressure and increased with increasing pulse frequency and pulse width. We have demonstrated that energetic VUV photons of 9.8 eV can be efficiently generated in a dielectric barrier discharge in Ar.

Introduction

Excimer lamps are capable of delivering high power, high efficiency and narrowband radiation. These sources emit intense ultraviolet (UV) radiation at specific wavelengths that can selectively generate radicals. High gas pressure is necessary to ensure that excimer formation is faster than radiative decay,¹ whilst the small radiative lifetime and broad spectral width of excimer bound-free transitions require a high-excitation power density.² Excimer lamps radiate in the UV and vacuum ultraviolet (VUV) spectral bands as a result of radiative decay of exciplex and excimer molecules.³ In this study, we aimed to develop an efficient VUV source and to determine the optimum operating conditions for VUV generation. VUV sources can be used in bacterial deactivation and the sterilisation of medical equipment, as well as an alternative treatment to thermal pasteurisation in the food industry.

The kinetic model we used follows the known energy flow in excited argon at high density. Figure 1 shows some of the transitions taking place in argon (Ar) when it is electrically excited. Of the four levels in the 3p⁵4s configuration of Ar, the $J = 0$ (³P₀) and the $J = 2$ (³P₂) are metastable. The two metastable levels, ³P₀ and ³P₂, lie at 11.55 eV and 11.72 eV, respectively, above the ground state. According to their statistical weights ($g = 2J+1$, where J is the total angular momentum quantum number of the state), the ³P₀ level is expected to be five times less populated than the ³P₂ level.⁴ In general, Ar atoms, such as those involved in discharge Ar₂* excimer kinetics, are ionised by multistep processes to provide the electron source, where the required energy of the electrons is acquired from the applied electric field. The second Ar continuum has its peak at 126 nm and a bandwidth of 10 nm.¹

The spatial distribution of discharge processes in noble gases and in noble gas-halogen mixtures at a given pressure and flow rate varies strongly according to the applied voltage waveform. The discharge can form separate glow discharge domains, or symmetrical or cone-shaped blurred discharge areas. With increasing applied power (i.e. operating at high voltage and low frequency or low voltage and high frequency), the non-uniform and patterned discharge distribution becomes gradually more uniform. Uniformity is necessary to keep peak current densities and gas temperature low, which is an important condition for efficient electrical to radiative energy conversion in the plasma. For pulsed excitation, there are at least two factors that are considered to be crucial for obtaining high conversion efficiencies: fast voltage rise times and short pulse widths,⁵ both of which were investigated in this study. Fast rise times produce a more uniform spatial distribution of the discharge plasma whilst short pulse widths terminate the applied voltage immediately after ignition thereby significantly decreasing the rate of ion energy dissipation.⁶

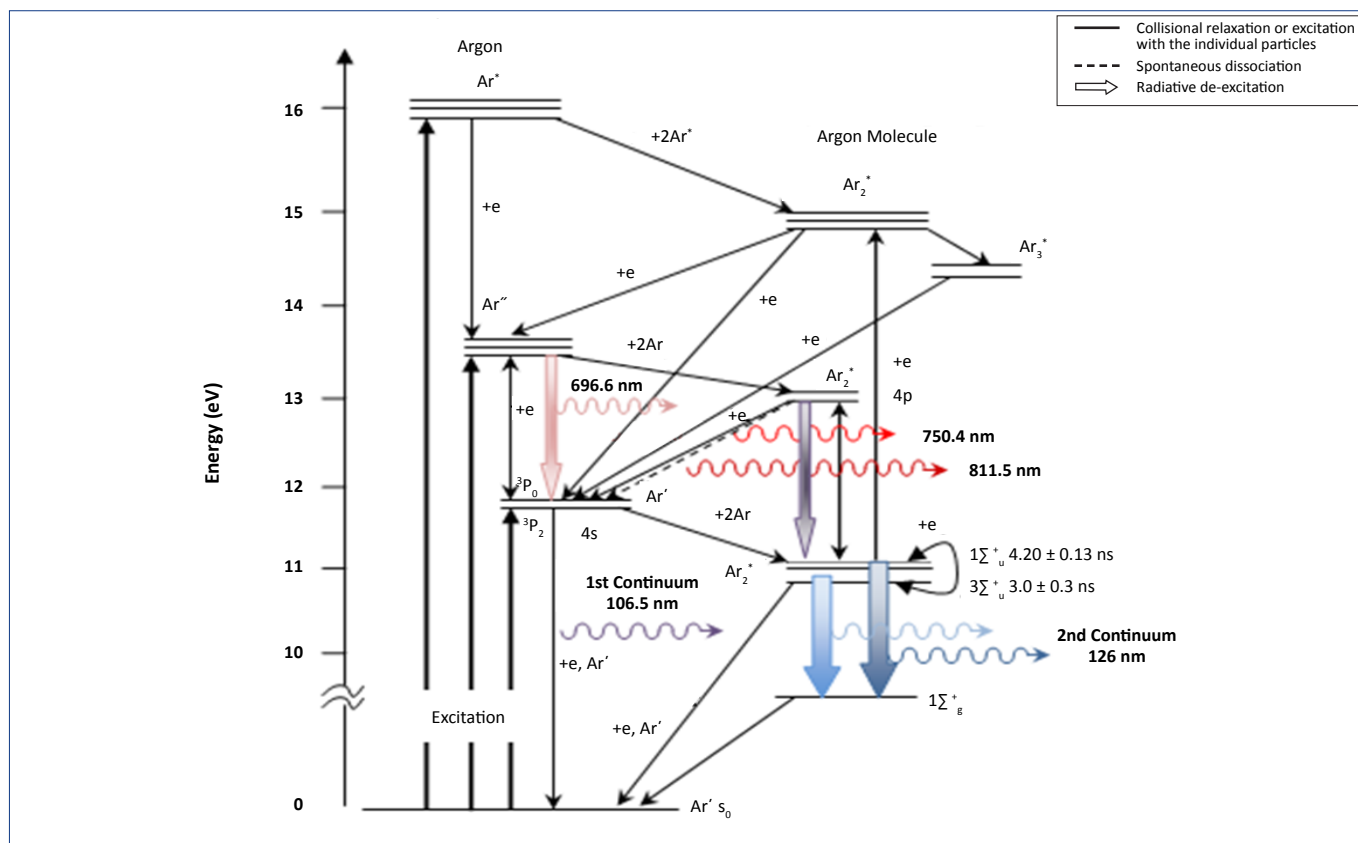

The $3p^4s$ level is drawn as a doublet, with the non-metastable members ignored.

FIGURE 1: Energy level for atomic and molecular argon excited by a dielectric barrier discharge, showing transitions leading to the 126 nm, 750.4 nm and 811.5 nm emissions.

Experimental method

A coaxial lamp configuration excited by a dielectric barrier discharge (DBD) was employed to generate VUV and visible light. Pyrex, 1.8 mm thick, was used as the dielectric material covering both electrodes. The outer tube section was wrapped with a wire mesh electrode of 80% transparency whilst a thinner tube enclosing the grounded and water cooled copper mesh electrode was placed coaxially at the centre (Figure 2). The lamp is 150 mm long, the outer tube has a 22 mm inner diameter with the outer diameter of the central tube being 12 mm, allowing an annular discharge gap of 5 mm. A 1-inch CaF_2 window fitted at one of the ends of the outer tube allowed observation of the VUV radiation.

Gas pressure was varied between 500 mbar and 1000 mbar, as VUV intensities at lower pressures were insignificant. The DBD discharge works with dynamic gas flow, meaning that gas flows continuously during discharge operation⁷ in order to minimise the effect of gas contamination from vessel walls and construction materials on the DBD plasma. High purity Ar gas (99.99%) was used and the flow rate could be varied between 0 slm and 10 slm (standard litre per minute).

The discharge was driven by a high-voltage, high-frequency, bipolar pulser generating square excitation pulses with 12 kV peak-to-peak amplitude, variable pulse durations of 1 μs – 6 μs and with voltage rise and fall times of about 200 ns. Excitation frequency could be varied between 0 kHz and 55 kHz.

The VUV emission spectrum was recorded using a vacuum spectrometer (Model 218, McPherson, Chelmsford, MA, USA) with standard two-mirror Czerny Turner layout fitted with a solar blind photomultiplier tube with a wavelength range from 115 nm to 200 nm (Type R6835, Hamamatsu, Shizuoka-ken, Japan). The spectrometer was maintained at a gas pressure of $\sim 10^{-5}$ mbar during the experiments. The VUV intensities reflect photomultiplier tube voltage measurements. The recording of the near infrared (NIR) spectrum was carried out with a fibre-coupled, high-resolution spectrometer (HR4000 CG-UV-NIR, Ocean Optics, Dunedin, FL, USA). The experimental set-up that was used is shown in Figure 2.

Results and discussion

Effect of gas pressure on line intensities

At high gas pressure, collisions promote rapid electronic and vibrational relaxation to the lowest lying energy levels. The reactions forming the Ar_2^* excimer state are mainly caused by three-body collisions: $\text{Ar}^* + 2\text{Ar} \rightarrow \text{Ar}_2^*(^3\Sigma_u^+) + \text{Ar}$, $\text{Ar}^* + 2\text{Ar} \rightarrow \text{Ar}_2^*(^1\Sigma_u^+) + \text{Ar}$ and $\text{Ar}_2^*(^3\Sigma_u^+) + e \rightarrow \text{Ar}_2^*(^1\Sigma_u^+) + e$, which have been found to be strong destruction processes for the lower metastable (3P_2) state in krypton⁸ and neon.⁹

The 126 nm emission (Figure 3a) increased with increasing total gas pressure according to a second-order polynomial (Figure 3b), confirming that a two-body collision¹⁰ is required for de-excitation to the ground state (1S_0) of molecular Ar.

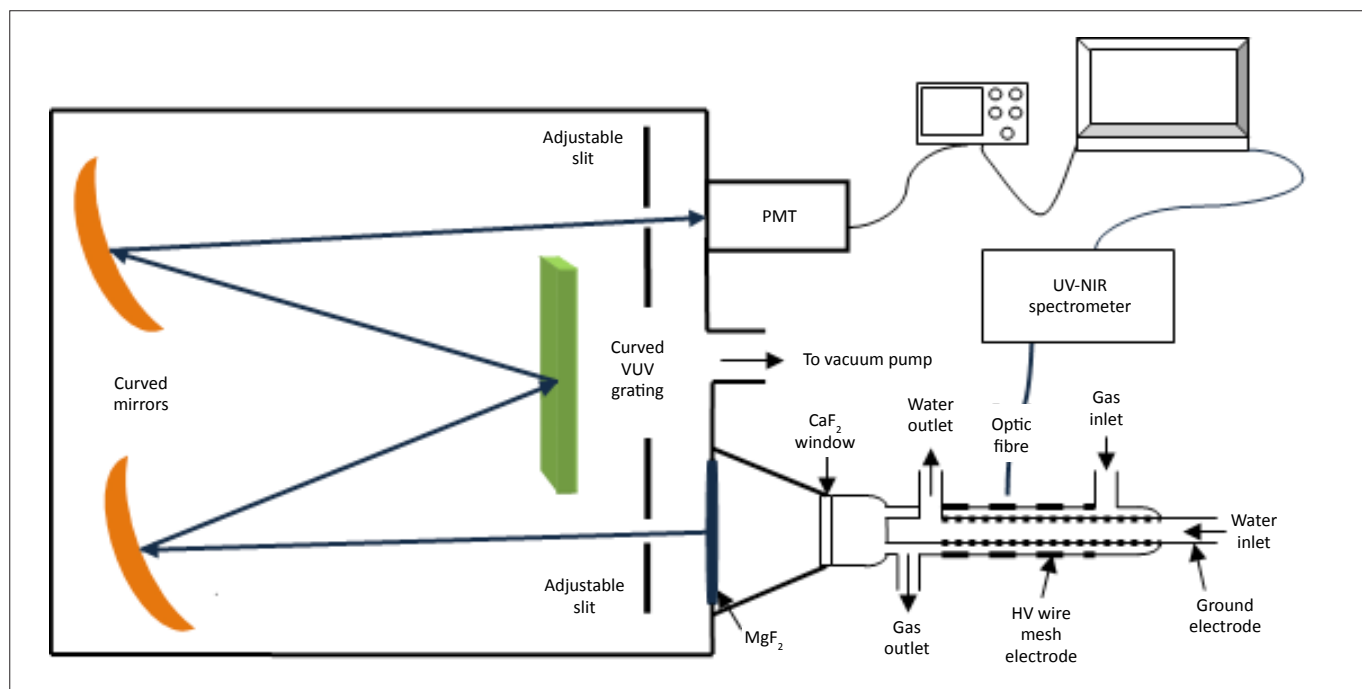

PMT, photomultiplier tube; UV-NIR, ultraviolet-near infrared; VUV, vacuum ultraviolet; HV, high voltage.

FIGURE 2: Experimental set-up showing the monochromator with the photomultiplier and the excimer lamp attached.

High pressures were shown to enhance VUV emission and no significant emission at pressures below 500 mbar was detected under our experimental conditions. Similar results were obtained by Zhang⁶ for a XeI* excimer lamp. At high gas pressure, the vibrational relaxation of metastables is very fast.⁹

In the NIR region, the intensity of the 750.4 nm line (Figure 4a) significantly decreased at pressures above 700 mbar, confirming the destruction of the upper metastable state (3P_0) as a result of enhanced three-body collisions. The intensity of the 811.5 nm line (Figure 4b) increased with increasing pressure up to a certain maximum value and then remained constant. The rapid dissociation of vibrationally excited $Ar_2^*(^3\Sigma_u)$ by plasma electrons led to a saturation in the population of $Ar_2^*(^1\Sigma_u)$ with rising pump density.¹¹ Saturation indicates that, at pressures above 700 mbar, three-body collisions are required for high metastable populations.

The intensity of the 811.5 nm line did not increase because of self-absorption. This finding was observed for various gas flow rates, but saturation in intensity of this line is reached more quickly at high flow rate. Similar results were obtained by Bletzinger and Ganguly¹² for the 750.4 nm line in their work with Ar.

Effect of excitation pulse frequency on line intensities

Efficient emission of VUV in excimer lamps requires that the excitation frequency should enable the electrons to move from one electrode to the other, whilst ensuring that the heavy metastable species, in particular, remain in the

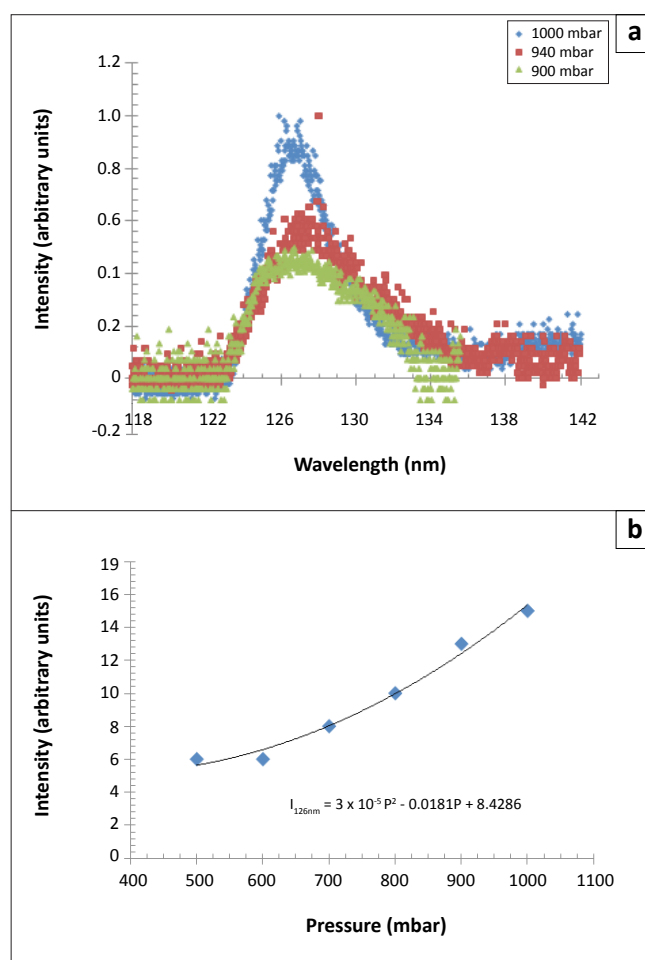
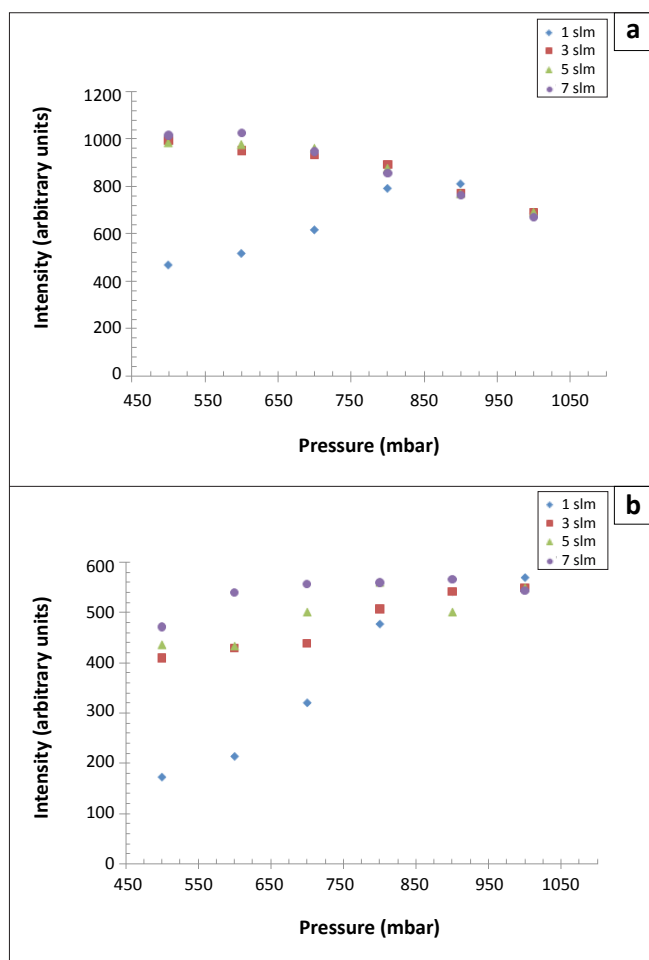

FIGURE 3: (a) Argon vacuum ultraviolet second continuum intensity observed at different pressures and (b) the variation of the peak intensity at 126 nm with pressure.



slm, standard litre per minute.

FIGURE 4: Effect of increasing pressure on the intensities of the (a) 750.4 nm and (b) 811.5 nm argon emissions.

gap. At frequencies that are too high, electrons are trapped in the gap resulting in gas heating, which is not favourable to metastable formation. This phenomenon is reflected in Figure 5 where the intensity of the VUV emission decreases with increasing frequency. The peak intensity at 126 nm shows a linear decrease with increasing pulse frequency. These results suggest that, for our lamp at the given operating conditions (i.e. a pressure of 1 bar and gas flow rate of 2 slm), high operating frequencies do not result in efficient VUV emission.

The observed NIR emission exhibited a behaviour opposite to that of the VUV emission. The two analysed lines reflected a similar behaviour for a given flow rate, that is, the intensity increased with increasing pulse frequency, as shown by Figures 6a and 6b, because of increasing energy input into the discharge leading to enhanced population of higher energy levels. On de-excitation, excimers populated the metastable state leading to emission of the 750.4 nm and 811.5 nm lines. However, because of the high pulse frequencies, three-body collisions required for the VUV emission were reduced, resulting in the reduction of VUV intensity. A build-up of the population of the low-lying Ar^* levels led to the enhanced formation of Ar_2^* excimers, which implies an increase in

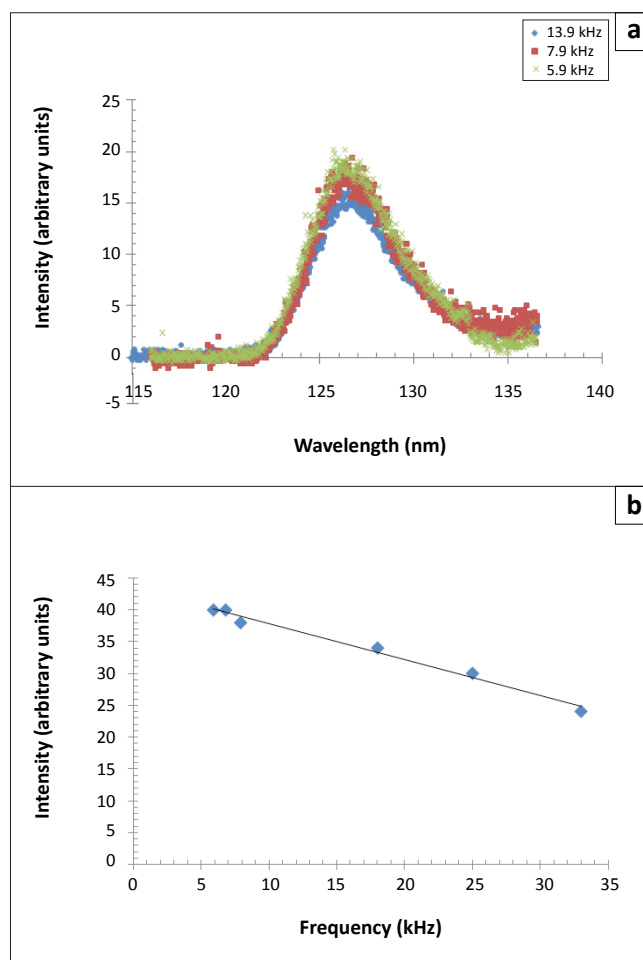

FIGURE 5: (a) Argon vacuum ultraviolet second continuum intensity at different frequencies and (b) the variation of the peak intensity at 126 nm with frequency.

excimer formation rates. This increase in excimer formation rates increases plasma ionisation as a result of the dissociation of Ar_2^* excimers, which are in a highly excited vibrational state, colliding with electrons.² Similar results have been obtained in the UV and visible range by Ou and his group in their work with XeI^* .¹³

Effect of excitation pulse width on line intensities

Excitation pulse widths were varied between 1.2 μs and 6.2 μs . Short pulse widths resulted in high intensities of VUV emission lines with the peak intensity at 126 nm decreasing linearly with an increase in pulse width (Figures 7a and 7b). When a very short pulse was used, metastable states were excited and there was sufficient time for radiative decay to take place before the arrival of the next excitation pulse. This observation is in contrast to the expectation that pulse width should have little or no effect on intensity because it is assumed that pulse frequency and associated input power stay constant when pulse width is varied.

There was no change in the intensity of the 750.4 nm and 811.5 nm lines with respect to pulse width for frequencies lower than 15 kHz (Figure 8a and 8b). A notable increase in

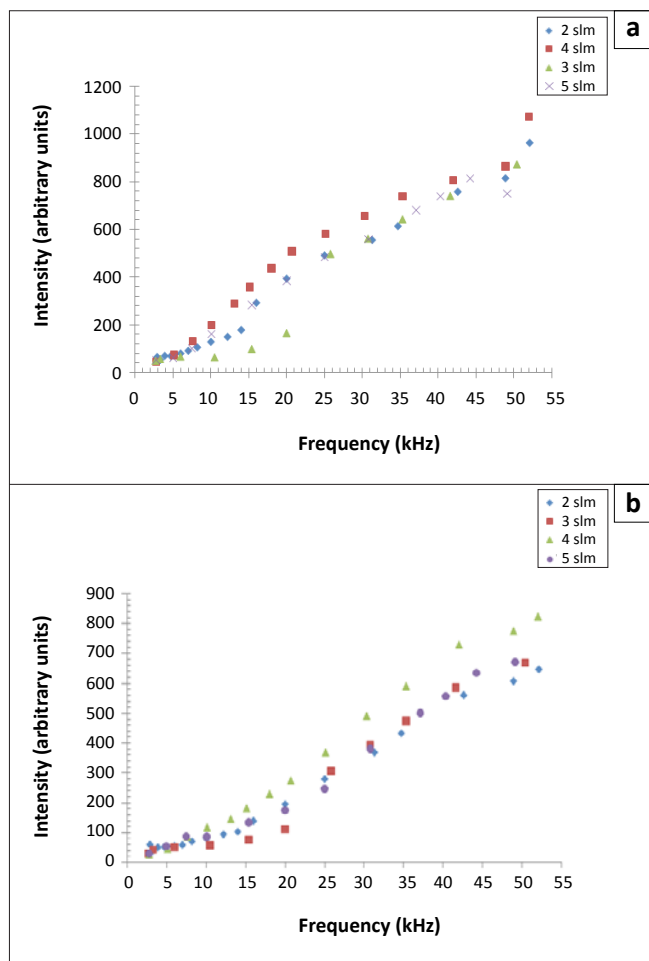

slm, standard litre per minute.

FIGURE 6: Effect of increasing frequency on the intensities of the (a) 750.4 nm and (b) 811.5 nm argon emissions.

intensity of these two lines with increasing pulse width was, however, observed at a frequency of 33 kHz. This observation could be as a result of heating effects taking place in the gas resulting in destruction of metastable states, thereby slightly increasing intensity. There was no distinct difference in the response of the two NIR emission lines to the change in pulse width over the frequency range used.

Effect of gas flow rate on line intensities

The intensity of the VUV emission shown in Figure 9a increased linearly with flow rate; this finding was also reported by Masoud et al.¹⁴ Gas flow rates were varied over the range of 1 slm to 11 slm. Only a minimal influence of flow rate on the intensity of the NIR lines was observed with both the 750.4 nm and 811.5 nm emissions showing similar behaviour when flow rate was increased (Figure 9b). High flow rates result in cooling of the gas and impurities are removed more efficiently from the discharge area, thereby enhancing metastable formation. In addition, the intensity of the second excimer continuum is particularly sensitive to quenching collisions with gas impurities because of the long radiative lifetime of the emitting state. Reducing impurities by increasing the flow rate results in efficient quenching

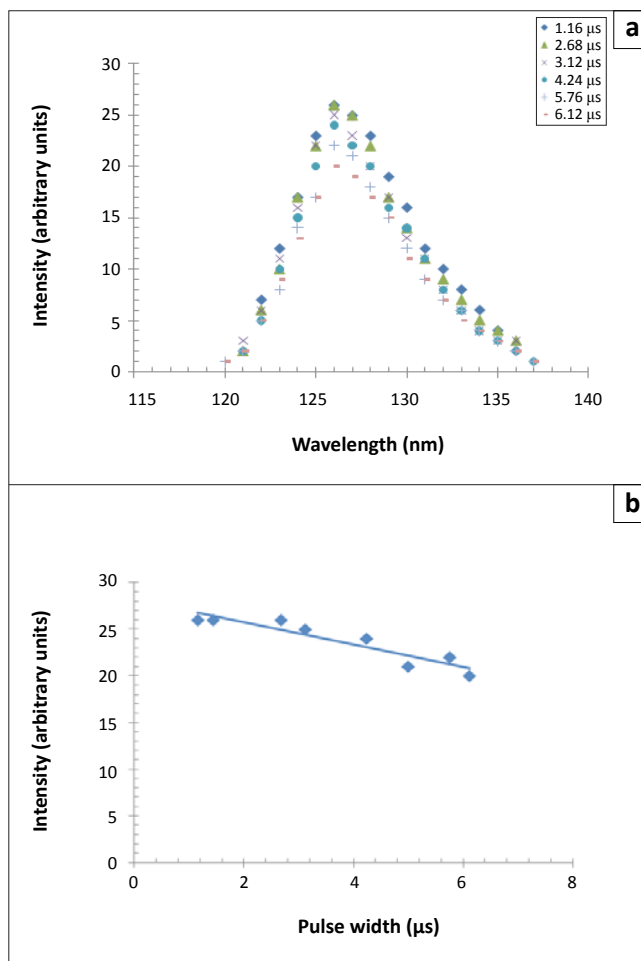

FIGURE 7: (a) Argon vacuum ultraviolet second continuum intensity observed at different pulse widths and (b) the variation of the peak intensity at 126 nm with pulse width.

and an increase in the intensity of the second continuum. This relationship is reflected in the NIR emission at high flow rate (Figure 9b), at which the intensities of the 750.4 nm and 811.5 nm lines suddenly decrease, and is also shown in Figures 3a, 5a and 5b, in which the VUV intensity increased with an increase in flow rate.

Conclusions

We analysed the second continuum VUV Ar_2^* excimer radiation and two NIR lines (750.4 nm and 811.5 nm). The second continuum of Ar has its peak at 126 nm and a full width at half maximum of 10 nm, as confirmed by our measurements. We observed that the intensity variation of the second continuum is opposite to that of the NIR lines. Excimer formation was efficient at low pulse frequencies, small pulse widths and at high pressures, whilst NIR intensities were enhanced at low pressures. Intensity of the Ar second continuum increased with pressure, following a second-order polynomial. Increasing gas flow rate enhanced excimer formation as it contributed to the cooling of the gas and removed gas impurities. Intensity of the NIR lines increased with frequency. As pressure increased, the intensity of the 750.4 nm line decreased, whilst the intensity

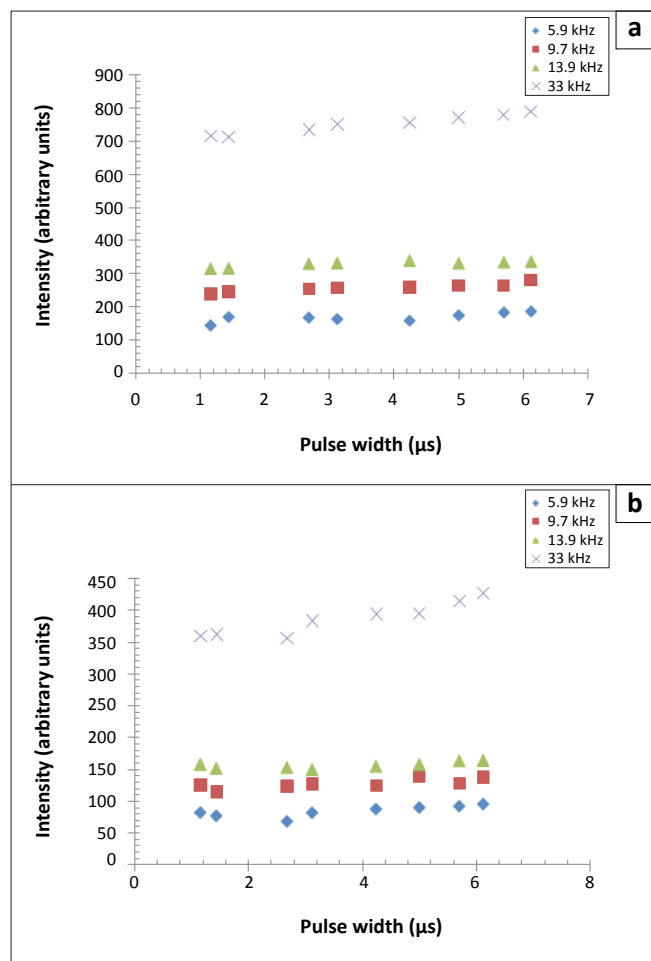

FIGURE 8: Effect of increasing pulse width on the intensities of the (a) 750.4 nm and (b) 811.5 nm argon emissions.

of the 811.5 nm line increased steadily until saturation. These relationships indicate a large cross section of the process leading to the emission of the 811.5 nm line at high pressure, whilst the opposite was true for the 750.4 nm line. Pulse width and gas flow rates seem not to have had a significant influence on the intensity of the NIR lines. An optimised VUV emission was obtained at high gas pressures (~1 bar) and low pulse repetition rates (~6 kHz).

This work has demonstrated that comparatively simple DBD excimer lamps can be used to generate significant VUV output intensities, which can be employed for sterilisation. Such lamps could be a suitable replacement for heat treatment, hydrogen peroxide or ethylene oxide methods used in the sterilisation of medical devices. The VUV emitted could also be used for bacterial inactivation in the food industry. Preliminary experiments have demonstrated the effectiveness of the emitted VUV for the inactivation of *Escherichia coli* bacteria.

Acknowledgements

We acknowledge the African Laser Centre for funding the research and the Laser Research Institute at Stellenbosch University for the use of their facilities.

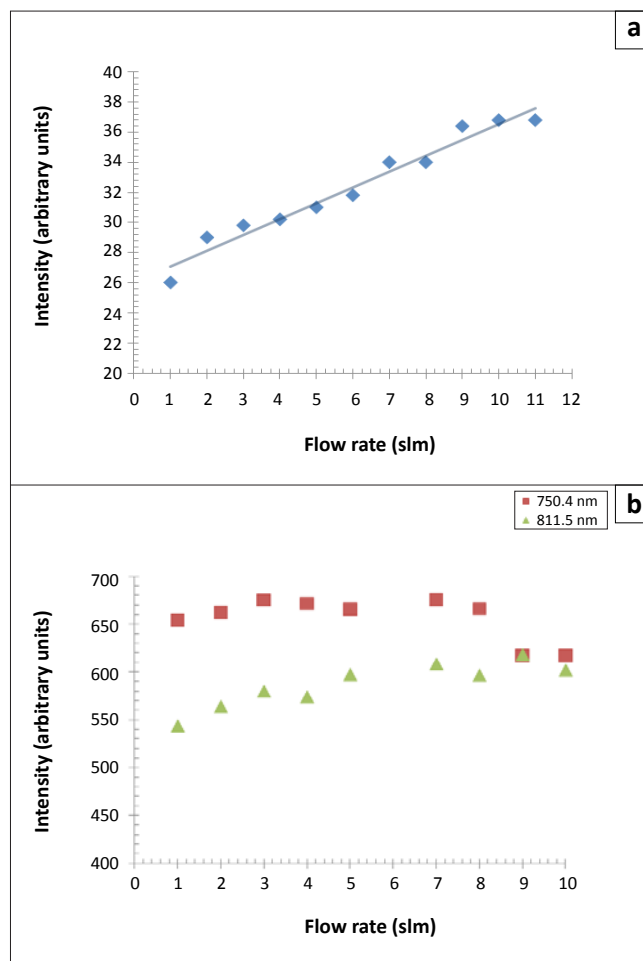

slm, standard litre per minute.

FIGURE 9: Effect of gas flow rate on the (a) vacuum ultraviolet and (b) near infrared argon emissions.

Competing interests

We declare that we have no financial or personal relationships which may have inappropriately influenced us in writing this article.

Authors' contributions

Mr P. Baricholo did the experimental work and obtained the results presented. He also prepared the initial draft which was circulated to the co-authors. Mr T. Stehmann helped in the design of the power supply and in the characterisation of the power supply. Prof. E.G. Rohwer supervised the experiments and helped with data analysis, paper presentation and layout. Prof. H.M. von Bergmann supervised the study and assisted with the experimental set-up and the methods used in the detection of excimer lamp output. Prof. von Bergmann also assisted in the optimisation of the experimental system as well as in the preparation of the final draft submitted for publication. Dr D.J. Hlatywayo assisted in supervising the project and in checking the adherence of the paper to the journal requirements. His contribution also included content evaluation and document formatting. Prof. M. Collier assisted with the analysis of the results, content verification, referencing and graphical preparation of the figures presented.



References

1. Elsner C, Lenk M, Prager L, Mehnert R. Windowless argon excimer source for surface modification. *Appl Surf Sci.* 2006;252:3616–3624. <http://dx.doi.org/10.1016/j.apsusc.2005.05.071>
2. Treshchalov AB, Lissovski AA. VUV–VIS spectroscopic diagnostics of a pulsed high-pressure discharge in argon. *J Phys D: Appl Phys.* 2009;42(245203):14.
3. Tarasenko VF, Shitts DV, Lomaev MI. About the formation of a barrier discharge in a KrCl excilamp. *Rus Phys J.* 2003;46(7):3.
4. Bager N, Bogaerts A, Donko Z, Gijbels R, Sadeghi N. Study of the Ar metastable atom population in a hollow cathode discharge by means of a hybrid model and spectrometric measurements. *J Appl Phys.* 2005;97(123305):1–12.
5. Carman RJ, Mildren RP, Ward BK, Kane DM. High-pressure (>1 bar) dielectric barrier discharge lamps generating short pulses of high-peak power vacuum ultraviolet radiation. *J Phys D: Appl Phys.* 2004;37:2399–2407. <http://dx.doi.org/10.1088/0022-3727/37/17/010>
6. Zhang J-Y, Boyd IW. Efficient XeI* excimer ultraviolet sources from a dielectric barrier discharge. *J Appl Phys.* 1998;84(3):1174–1178. <http://dx.doi.org/10.1063/1.368182>
7. El-Dakroui A, Yan J, Gupta MC, Laroussi M, Badr Y. VUV emission from a novel DBD-based radiation source. *J Phys D: Appl Phys.* 2002;35(21):L109–L114.
8. Hirose K, Sugahara H, Matsumo H. Basic performance of VUV exposure systems using head-on type Ar₂* and Kr₂* DBD excimer lamps. *J Lig Vis Environ.* 2002;26(1):35–41.
9. Carman RJ, Kane DM, Ward BK. Enhanced performance of an EUV light source ($\lambda = 84$ nm) using short-pulse excitation of a windowless dielectric barrier discharge in neon. *J Phys D: Appl Phys.* 2010;43(025205):L1–L6.
10. Becker KH, Masoud NM, Martus KE, Schoenbach KH. Electron-driven processes in high-pressure plasmas. *Eur Phys J D.* 2005;35(2):279–297. <http://dx.doi.org/10.1140/epjd/e2005-00199-0>
11. Neeser S, Kunz T, Langhoff H. A kinetic model for the formation of Ar₂ excimers. *J Phys D: Appl Phys.* 1997;30:1489–1498. <http://dx.doi.org/10.1088/0022-3727/30/10/016>
12. Bletzinger P, Ganguly BN. The effect of displacement current on fast-pulsed dielectric barrier discharges. *J Phys D: Appl Phys.* 2003;36:1550–1552. <http://dx.doi.org/10.1088/0022-3727/36/13/318>
13. Ou QR, Meng YD, Xu X, Shu XS, Ren ZX. Effect of frequency on emission of XeI* excimer in a pulsed dielectric barrier discharge. *Chin Phys Lett.* 2004;21(7):1317–1319. <http://dx.doi.org/10.1088/0256-307X/21/7/037>
14. Masoud N, Martus K, Becker K. VUV emission from a cylindrical dielectric barrier discharge in Ar and in Ar/N₂ and Ar/air mixtures. *J Phys D: Appl Phys.* 2005;38:1674–1683. <http://dx.doi.org/10.1088/0022-3727/38/11/006>