

# **THE DEVELOPMENT AND PSYCHOMETRIC EVALUATION OF A GRADUATE LEADER COMPETENCY QUESTIONNAIRE**

**Jacques Pienaar**

**Dissertation presented in fulfilment of the requirements for the degree of Doctor  
of Commerce (Industrial Psychology) in the Faculty of Economic and Management  
Sciences at Stellenbosch University**

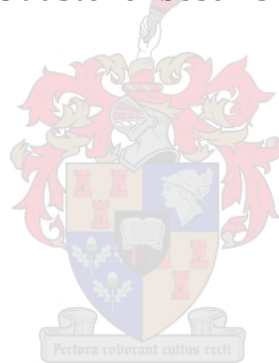

**SUPERVISOR: PROFESSOR C.C. THERON**

**DECEMBER 2020**

## **DECLARATION**

By submitting this dissertation electronically, I declare that the entirety of the work contained herein is my own, original work, that I am the sole author thereof (save to the extent explicitly otherwise stated), that reproduction and publication thereof by Stellenbosch University will not infringe any third party rights and that I have not previously in its entirety or in part submitted it for obtaining any qualification.

**Signed: J.S. Pienaar Date: August 2020**

## ABSTRACT

The impending retirement of a large number of industry's senior and most influential leaders (mostly from Generation X) around the world is increasingly putting pressure on HR departments to be able to identify management potential from and accelerate the leadership development of the latest generation to enter the workforce (i.e. Generation Y) in order to deliver a supply of high calibre executives and leaders for the future. In order to diagnose the causes of low levels of employability amongst Generation Y graduates emanating from South African universities, to inform the recruitment and selection of these graduates as well as their development upon entry into the organisation, and to inform interventions aimed at the development of psychological states that affect (intrinsic) work motivation and lower turnover intention, that in turn, are all necessary prerequisites for the development of effective leadership acceleration programmes, the complex nomological network of latent variables characterising the graduate employee (i.e. transient psychological states, malleable attainments and rather inflexible, non-malleable dispositions) and characterising the work environment (i.e. job characteristics, job demands, span of control, etc.) that affect graduate leader performance and turnover, first need to be validly mapped and understood. This research challenge naturally broaches the questions as to what graduate leader performance means, and secondly, how graduate leader performance can be measured.

The research design utilised a *mixed method approach* (coupling quantitative and qualitative methodologies) to develop answers to these afore-mentioned questions. The long-term goal was ultimately to conceptualise the graduate leader performance construct (i.e. what graduate leader performance means) as a five-domain job performance hypothesis (i.e. a *competency model approach to job performance*) in which the relevant latent variables in the competency potential, competency, competency outcomes, competency requirements and job and organisational characteristics domains of this performance space are structurally mapped onto each other in a richly interconnected network of cause-and-effect relationships. Thus, the aforementioned competency model in terms of the abstract (and as-of-yet unknown) latent variables that populate its different domains needed to be fully explicated and empirically tested. However, as the full explication of such a multidomain hypothesis was considered a massive and overly ambitious undertaking and implied a multiphase project spanning a considerable amount of time, the focus of the present study was limited to the explication of the behavioural (or competency) domain of graduate leader performance only (or first). The explication of the other domains of the competency model (i.e. competency potential, competency outcomes, competency requirements and the job and organisational characteristics domains) will have to be targeted by future studies as a matter of priority.

The explication of the behavioural requirements of (graduate) leader performance ensued by way of a wide-ranging literature study on leadership and managerial requirements for the 21<sup>st</sup> century and in excess of 100 (first order) competencies were initially identified as being relevant to this cause. Thematic analysis was employed to group the (first-order) competencies into nine internally consistent themes and the relevance of these across South African organisations were confirmed through the employment of the Delphi method administered on sample of subject matter experts in the field. This led to hypothesising about the nature of the relationships between the nine (second-order) competencies and the derivation of a structural model that depicted the *to-be-tested* internal structure of the graduate leader performance construct (behaviourally interpreted). The question as to how graduate leader performance could be measured, on the other hand, was dealt with by developing an instrument (i.e. the PGLCQ) that could be used to measure these nine second-order competencies. The qualitative part of the study (more specifically the Critical Incident Technique field work) served as the basis for item development and the creation of behavioural anchors for these items. The PGLCQ eventually comprised of 90 questions (10 questions per competency) and utilised 5-point rating scales. The

psychometric properties of the PGLCQ were examined on a sample of  $n=133$  graduate leaders. While the initial plan was to collect multi-rater data (from the graduate leader and his or her manager) with which to analyse the psychometric properties of the PGLCQ, the data collection exercise was marred with a poor completion rate either from the side of the graduate or the manager (an incomplete response from either rendered the specific case unusable), and consequently this aim unfortunately did not realise. Nonetheless, the psychometric evaluation of the nine subscales of the PGLCQ by way of item and dimensionality analysis (self-rater responses) delivered results that were compatible with the position that all of them provided an adequate measure of the specific latent competency variables they were designed to assess (i.e. acceptable evidence was obtained to conclude their reliability and validity).

The reliability coefficients of the different subscales of the PGLCQ were, moreover, found to be of an exceptional standard and the subsequent fitting of the overall PGLCQ measurement model led to the conclusion of close fit in the parameter. In addition, as the LISREL output suggested that the item parcels of the PGLCQ competency questionnaire measurement model loaded satisfactorily and significantly on the latent variables they were earmarked to reflect, and the PGLCQ measurement model passed all tests of discriminant validity, the operationalisation of the latent variables that the graduate leader structural model comprises of were considered successful. On the other hand, when fitting the graduate leader performance construct to the comprehensive LISREL model, despite the fact that the exact and close fit hypotheses had to be rejected, acceptable model fit was nonetheless concluded as the Two-Index Presentation strategy combination rules provided sufficient evidence to argue that the fitted model was able to sufficiently accurately approximate the observed variance-covariance matrix. However, out of the eighteen path-specific hypotheses originally proposed, six could unfortunately not be corroborated. Five path coefficients associated with five path-specific hypotheses were found to be statistically insignificant in the beta matrix, while only one path coefficient associated with one path-specific hypothesis was found to be statistically insignificant in the gamma matrix. Nonetheless, support garnered for twelve of the original path-specific hypotheses resulted in the validation of a graduate leader performance (behaviourally interpreted) explanatory model, even if the internal structural relations between the latent variables included in the final model differed somewhat from the manner in which this psychological mechanism was initially thought to operate. Therefore, this study advances the quest for the availability and effective functioning of leaders in South African organisations via the practical suggestions offered for improving and accelerating leadership development as well as suggestions for future research to build on this, thus making a significant contribution to the development of a leading best practice approach to the recruitment, selection and development of high-performance graduate leaders for South Africa's future.

## OPSOMMING

Die naderende aftrede van groot hoeveelhede van industrie se senior en mees invloedryke leiers (meestal van Generasie X) op 'n globale vlak plaas toenemende druk op Menslike Hulpbron departemente om bestuurs-potensiaal in die nuutste generasie (Generasie Y) van werknemers te kan identifiseer en ontwikkel om sodoende 'n toepaslike hoeveelheid van hoë kaliber uitvoerende bestuur beskikbaar te hê vir die toekoms. Om die oorsake van lae vlakke van indiensneembaarheid van Generasie Y graduante te kan diagnoseer, om die werwing en keuring van hierdie graduante in te lig, en om intervensies in te lig wat fokus op die ontwikkeling van psigologiese toestande wat werks-motivering en werknemers se intensie om aan te bly in die organisasie aanmoedig, wat op hul beurt alles voorvereistes is vir die ontwikkeling van effektiewe leierskapontwikkeling programme, is dit nodig om die komplekse nomologiese netwerk van latente veranderlikes wat die Generasie Y graduantwerknemer (psigologiese toestande, smeebare vaardighede en nie-smeebare gesindhede/talente) en die werksplek (werk kenmerke, werkseise, mate van beheer oor werk, ens.) kenmerk wat graduant prestasie en hulle intensie om aan te bly in die organisasie affekteer, in 'n geldige manier te modelleer en op 'n dieper vlak te verstaan. Hierdie uitdaging vir navorsers opper dus natuurlik die vrae van wat graduant leier prestasie beteken, en tweedens, hoe graduant leier prestasie gemeet kan word.

Die studie se navorsingsontwerp het 'n *gemengde metode* benadering (kwalitatiewe and kwantitatiewe metodologie) gebruik om antwoorde te soek op hierdie bogenoemde vrae. Die langtermyn doelwit was om die graduantleier-prestasiestruktuur (die vraag van wat graduantleier-prestasie beteken) te konseptualiseer as 'n vyf-domein werksprestasie-hipotese ('n *bevoegdheidsmodel benadering* tot werksprestasie) waarin die relevante latente veranderlikes in die bevoegdheidspotensiaal, bevoegdheid (gedrag), bevoegdheidsuitkomstes, bevoegdheidsvereistes, en werk en organisatoriese kenmerke domeine van hierdie abstrakte prestasie ruimte struktureel op mekaar gemodelleer word in 'n ryk onderling gekoppelde stelsel van oorsaak-en-gevolg verhoudings. Dus moes hierdie bevoegdheidsmodel in terme van die abstrakte (en onbekende) latente veranderlikes wat die model se verskillende domeine vul ten volle ekspliseer en empiries getoets word. Omdat die volle eksplikasie van so 'n multi-domein hipotese as 'n reuse onderneming beoordeel was en 'n multi-fase projek impliseer het wat uitgerol sou moes word oor 'n aansienlike periode van tyd, was die fokus van die huidige studie beperk tot die eksplisering van die gedrag (of bevoegdheids) domein van graduantleier-prestasie alleen (of eerste). Die eksplisering van die ander domeine van die bevoegdheidsmodel (potensiaal, uitkomstes, vereistes en die werk en organisatoriese kenmerke) sal dus geteiken moet word deur toekomstige studies as 'n saak van prioriteit.

Die eksplisering van die gedragsvereistes van (graduante) leierprestasie het begin met 'n omvattende literatuurstudie op leierskap and bestuursvereistes vir die 21ste eeu, en meer as 100 (eerste-orde) bevoegdhede was oorspronklik identifiseer en klassifiseer as relevant vir hierdie doel. Tematiese analise was gebruik om die eerste-orde bevoeghede te groepeer in nege interne konsekwente temas en die relevansie van die temas was bevestig in Suid Afrikaanse organisasies met behulp van die gebruik van die Delphi metode wat geadminstreer was op steekproef van vakkundiges in die veld. Dit het gelei tot die ontwikkeling van hipoteses oor die aard van die verwantskap tussen die nege (tweede-orde) bevoegdhede en die afleiding van 'n strukturele model wat die teoretiese interne struktuur van die graduantleier-prestasiestruktuur (gënterpreer in terme van gedrag) uitgebeeld het. Die vraag van hoe graduantleier-prestasie gemeet kan word, aan die ander kant, was beantwoord deur die ontwikkeling van 'n instrument (die PGLCQ) wat kon gebruik word om hierdie nege tweede-orde bevoegdhede te meet. Die kwalitatiewe deel van die studie (en meer spesifiek die Kritieke Incident Tegniek) was gebruik as die basis vir itemontwikkeling en die skepping van gedragsankers vir die items. Die PGLCQ het uiteindelik uit 90 vrae bestaan (10 vrae vir elke bevoegdheid) en het gebruik gemaak van 5-punt

beoordelingskale. Die psigometriese eienskappe van die PGLCQ was beoordeel op 'n steekproef van  $n=133$  graduantleiers. Alhoewel die oorspronklike doel was om multi-beoordelaar data (vanaf die graduantleier en sy of haar bestuurder) in te samel en dit te gebruik om die psigometriese eienskappe van die PGLCQ te analiseer, was data-insameling belemmer deur 'n swak voltooiingskoers aan die kant van die graduant of die bestuurder ('n onvoltooide respons van enige een van hierdie respondente het die geval onbruikbaar gemaak), en hierdie voorneme het dus nie gerealiseer nie. Nietemin, die psigometriese evaluering van die nege subskale van die PGLCQ (persoonlike beoordelings) deur middel van item en dimensionaliteit ontledings het resultate gelewer wat verenigbaar is met die posisie dat al die subskale voldoende metings verskaf het van die latente bevoegdheidsveranderlikes wat hulle geormerk was om te beoordeel (aanvaarbare bewyse was gelewer om hul geldigheid en betroubaarheid te beaam). Die betroubaarheidskoëffisiënte van die subskale was verder van 'n uitsonderlike standaard en die passing van die algehele PGLCQ metings-model daarna het gelei tot die bevinding van goeie passing in die parameter. Daarbenewens en siende dat die LISREL afvoer suggereer het dat die item pakkies van die PGLCQ metings-model bevredigend en beduidend gelaai het op die latente veranderlikes wat hulle geormerk was om te reflekteer, en dat die metings-model alle toetse van diskriminante geldigheid geslaag het, was die operasionalisering van die latente veranderlikes wat ingesluit was in die graduant leier prestasie strukturele model beskou as suksesvol.

Aan die ander kant, toe die volledige graduant leier prestasie LISREL-model gepas was, en ten spyte van die feit dat presiese en nabye passing verwerp moes word, was aanvaarbare passing nietemin bereik soos beoordeel in terme van die Twee-Indeks strategie kombinasie reëls wat voldoende bewyse voorsien het om te kan argumenteer dat die gepasde model in staat was om die waargenome variansie-kovariansie matriks redelik akkuraat te kon skat. Ses uit die oorspronklike pad-spesifieke hipoteses kon egter nie bevestig word nie. Vyf koëffisiënte geassosieër met vyf pad-spesifieke hipoteses was statisties onbeduidend in die beta matriks, en een koëffisiënt was statisties onbeduidend in the gamma matriks. Nietemin, die bevinding dat twaalf van die oorspronklike pad-spesifieke hipoteses statisties beduidend was het gelei tot die validering van 'n graduant leier prestasie (geïnterpreteer in terme van gedrag) verklarende model, al het die interne strukturele verhoudings tussen die latente veranderlikes in die finale model ietwat verskil van hoe hierdie psigologiese meganisme oorspronklik gekarteer was. As sulks het die studie vooruitgang gemaak in die strewe na die beskikbaarheid en effektiewe funksionering van leiers in Suid Afrikaanse organisasies via die praktiese voorstelle vir die verbetering en bevordering van leierskapontwikkeling sowel as die voorstelle vir toekomstige navorsing om hierop te bou, en dus het die studie 'n beduidende bydrae gemaak tot die ontwikkeling van 'n toonaangewenede beste praktyk benadering tot die werwing, seleksie en ontwikkeling van hoë prestasie leiers vir Suid Afrika se toekoms.

## **ACKNOWLEDGEMENTS**

This research project would not have been possible without the guidance and support of Prof Theron. Thank you, and I truly appreciate the belief you had in me, as well as your patience, effort and time. It has been a pleasure and honour working with and learning from you over the past few years. There is no other supervisor but you with whom I would have set out on this journey.

I would also like to thank the University's Graduate School (GEM) for their financial support, without which it would have been difficult, if not impossible, to complete this study.

To all my friends and family who supported me in various ways during the course of this study, I am forever grateful for your patience and support as well. I am blessed to have such caring and loyal people in my life and hope that we can spend many more joyful and meaningful years together. Last but not least, this project is dedicated to my parents. May the Lord keep you safely in His arms until we meet again.

## TABLE OF CONTENTS

### CHAPTER 1: BACKGROUND AND RESEARCH OBJECTIVES

1.1	INTRODUCTION.....	1
1.2	HUMAN RESOURCE MANAGEMENT AS A KEY DRIVER OF PERFORMANCE .....	2
1.3	THE FUTURE: GENERATION Y GRADUATES AND THE HUMAN RESOURCES DEPARTMENT.....	5
1.4	GRADUATES AND THE DISPOSITIONS AND ATTAINMENTS DOMAIN .....	6
1.5	GRADUATES AND THE MOTIVATION AND EFFORT AND OPPORTUNITY TO CONTRIBUTE DOMAINS .....	16
1.6	RELEVANCE AND SIGNIFICANCE OF THE STUDY .....	22
1.7	RESEARCH PROBLEM AND RESEARCH INITIATING QUESTIONS .....	24
1.8	OBJECTIVES OF THE STUDY .....	25
1.9	CONCLUSION .....	26

### CHAPTER 2: LITERATURE STUDY

2.1	INTRODUCTION.....	27
2.2	THE COMPETENCY APPROACH TO JOB PERFORMANCE MODELLING.....	27
2.3	THE JOB PERFORMANCE CONSTRUCT .....	38
2.4	THE JOB OF A GRADUATE: A WORK IN PROGRESS .....	43
2.5	PHILOSOPHICAL DEBATES ON LEADERSHIP .....	46
2.6	THE EXPLICATION OF THE GRADUATE PERFORMANCE CONSTRUCT .....	53
2.7	THE PROPOSED GRADUATE LEADER PERFORMANCE STRUCTURAL MODEL .....	96
2.8	CONCLUSION .....	119

### CHAPTER 3: RESEARCH DESIGN

3.1	INTRODUCTION.....	120
3.2	A MIXED METHOD APPROACH.....	120
3.3	SUBSTANTIVE RESEARCH HYPOTHESES.....	122
3.4	RESEARCH DESIGN .....	126
3.5	STATISTICAL TECHNIQUE: STRUCTURAL EQUATION MODELLING.....	129
3.6	STATISTICAL HYPOTHESES.....	132
3.7	MEASUREMENT INSTRUMENT – THE DEVELOPMENT OF THE PGLCQ.....	136
3.8	SAMPLING STRATEGY AND RESEARCH PARTICIPANTS.....	145
3.9	STATISTICAL ANALYSIS .....	148
3.10	CONCLUSION .....	175



**CHAPTER 4: ETHICAL CONSIDERATIONS**

4.1	INTRODUCTION.....	176
4.2	SCIENTIFIC INTEGRITY.....	176
4.3	SCIENTIFIC MORALITY .....	178
4.4	ETHICAL STRATEGIES.....	181
4.5	RISK-BENEFIT ANALYSIS.....	188
4.6	CONCLUSION .....	189

**CHAPTER 5: RESEARCH RESULTS**

5.1	INTRODUCTION.....	190
5.2	DEVELOPMENT OF THE PGLCQ.....	190
5.3	QUANTITATIVE ANALYSIS: SAMPLE GROUP DEMOGRAPHIC CHARACTERISTICS.....	194
5.4	MISSING VALUES .....	203
5.5	ITEM AND DIMENSIONALITY ANALYSIS FOR THE PGLCQ.....	204
5.6	PSYCHOMETRIC EVALUATION OF THE PGLCQ COMPETENCY QUESTIONNAIRE MEASUREMENT- AND COMPREHENSIVE GRADUATE LEADER PERFORMANCE LISREL MODELS .....	268
5.7	PSYCHOMETRIC EVALUATION OF THE COMPREHENSIVE GRADUATE LEADER PERFORMANCE LISREL MODEL.....	290
5.8	EXAMINING THE FIT OF THE COMPREHENSIVE GRADUATE LEADER PERFORMANCE LISREL MODEL.....	293
5.9	EXAMINING THE COMPREHENSIVE GRADUATE LEADER PERFORMANCE LISREL MODEL RESIDUALS.....	299
5.10	ASSESSING THE STRUCTURAL RELATIONSHIPS IN THE COMPREHENSIVE GRADUATE LEADER PERFORMANCE LISREL MODEL .....	301
5.11	EVALUATION OF THE STRUCTURAL ERROR VARIANCES IN THE COMPREHENSIVE GRADUATE LEADER PERFORMANCE LISREL MODEL .....	310
5.12	MODIFICATION INDICES CALCULATED FOR THE COMPREHENSIVE GRADUATE LEADER PERFORMANCE LISREL MODEL .....	311
5.13	CONCLUSION .....	316

**CHAPTER 6: DISCUSSION AND CONCLUSION**

6.1	INTRODUCTION.....	317
6.2	RESEARCH OBJECTIVES.....	317
6.3	OVERVIEW OF THE CURRENT STUDY.....	318
6.4	DISCUSSION OF RESULTS .....	324
6.5	OVERARCHING CONCLUSION ON THE CONSTRUCT VALIDITY OF THE PGLCQ .....	333
6.6	MANAGERIAL IMPLICATIONS.....	335
6.7	LIMITATIONS .....	345
6.8	RECOMMENDATIONS FOR FUTURE RESEARCH.....	347

6.9	CONCLUSION .....	348
-----	------------------	-----

## LIST OF TABLES

Table 2.1	Influential competency definitions .....	<b>Error! Bookmark not defined.</b>
Table 2.2	An example of a (narrowly) operationalised competency model .....	<b>Error! Bookmark not defined.</b>
Table 2.3	Examples of job demands and job resources for Generation Y Graduates .....	<b>Error! Bookmark not defined.</b>
Table 2.4	Descriptive comparisons between leadership and management .....	<b>Error! Bookmark not defined.</b>
Table 2.5	Descriptive comparisons between progressive levels of leadership .....	<b>Error! Bookmark not defined.</b>
Table 2.6	Leadership competencies extracted from the strategic subsystem .....	<b>Error! Bookmark not defined.</b>
Table 2.7	The philosophical differences between McGregor's Theory X and Theory Y	<b>Error! Bookmark not defined.</b>
Table 2.8	Differences between mechanistic and organic structures ...	<b>Error! Bookmark not defined.</b>
Table 2.9	Leadership competencies extracted from the structural and technological subsystems .....	<b>Error! Bookmark not defined.</b>
Table 2.10	Leadership as a social identity management process .....	<b>Error! Bookmark not defined.</b>
Table 2.11	Leadership competencies extracted from the human subsystem .....	<b>Error! Bookmark not defined.</b>
Table 2.12	Leadership competencies extracted from the managerial subsystem .....	<b>Error! Bookmark not defined.</b>
Table 2.13	Leadership outcomes extracted by way of a systems view of a work unit .....	<b>Error! Bookmark not defined.</b>
Table 2.14	Phases of thematic analysis .....	<b>Error! Bookmark not defined.</b>
Table 2.15	Second-order leadership competencies .....	<b>Error! Bookmark not defined.</b>
Table 3.1	Criteria for defining and investigating quality in qualitative research .....	<b>Error! Bookmark not defined.</b>
Table 3.2	CFA taxonomy for MTMM data .....	<b>Error! Bookmark not defined.</b>
Table 3.3	Descriptions and thresholds of goodness of fit indices contemplated for use in the assessment of both measurement and structural models .....	<b>Error! Bookmark not defined.</b>
Table 4.1	The Scope of Research Ethics .....	<b>Error! Bookmark not defined.</b>
Table 4.2	Strategies for abiding with HPCSA and National Health Act research ethics guidelines .....	<b>Error! Bookmark not defined.</b>

Table 4.3	Strategies for abiding with SU research ethics policy guidelines.....	<b>Error! Bookmark not defined.</b>
Table 5. 1	Delphi exercise: ratings assigned to the graduate leader competencies.....	<b>Error! Bookmark not defined.</b>
Table 5.2	Delphi exercise round one: Descriptive statistics.	<b>Error! Bookmark not defined.</b>
Table 5.3	Gender representation in the self-rater group.....	<b>Error! Bookmark not defined.</b>
Table 5.4	Gender representation in the other-rater group...	<b>Error! Bookmark not defined.</b>
Table 5.5	Race representation in the self-rater group.....	<b>Error! Bookmark not defined.</b>
Table 5.6	Race representation in the other-rater group.....	<b>Error! Bookmark not defined.</b>
Table 5.7	Years of experience in managing others: other-rater group	<b>Error! Bookmark not defined.</b>
Table 5.8	Home language representation in the self-rater group.....	<b>Error! Bookmark not defined.</b>
Table 5.9	Home language representation in the other-rater group.....	<b>Error! Bookmark not defined.</b>
Table 5.10	Geographic location of respondents in the self-rater group	<b>Error! Bookmark not defined.</b>
Table 5.11	Geographic location of respondents in the other-rater group.....	<b>Error! Bookmark not defined.</b>
Table 5.12	Area of study for the other-rater group.....	<b>Error! Bookmark not defined.</b>
Table 5.13	Area of study for the self-rater group.....	<b>Error! Bookmark not defined.</b>
Table 5.14	Industry representation for the other-rater group.....	<b>Error! Bookmark not defined.</b>
Table 5.15	Age of the other-rater group.....	<b>Error! Bookmark not defined.</b>
Table 5.16	Age of the self-rater group.....	<b>Error! Bookmark not defined.</b>
Table 5.17	Highest qualification of the self-rater group.....	<b>Error! Bookmark not defined.</b>
Table 5.18	Educational institution where highest qualification was obtained: self-rater group.....	<b>Error! Bookmark not defined.</b>
Table 5.19	Distribution of missing values across items of the PGLCQ...	<b>Error! Bookmark not defined.</b>
Table 5.20	Item analysis output for the displays personal leader proficiency subscale.	<b>Error! Bookmark not defined.</b>
Table 5.21	PRELIS test of multivariate normality output for the displays personal leader proficiency subscale .....	<b>Error! Bookmark not defined.</b>
Table 5.22	Unstandardised factor loading matrix ( $\Lambda_X$ ) for the displays personal leader proficiency measurement model .....	<b>Error! Bookmark not defined.</b>
Table 5.23	Completely standardised factor loading matrix ( $\Lambda_X$ ) for the displays personal leader proficiency measurement model .....	<b>Error! Bookmark not defined.</b>

Table 5.24	Unstandardised measurement error variance matrix ( $\Theta\delta_{ii}$ ) for the displays personal leader proficiency measurement model <b>Error! Bookmark not defined.</b>
Table 5.25	Completely standardised measurement error variance matrix ( $\Theta\delta_{ii}$ ) for the displays personal leader proficiency measurement model. <b>Error! Bookmark not defined.</b>
Table 5.26	R2 values for the displays personal leader proficiency measurement model ....213
Table 5.27	Item analysis output for the analyses and understands the external and internal work unit environment subscale ..... <b>Error! Bookmark not defined.</b>
Table 5.28	PRELIS test of multivariate normality output for the analyses and understands the external and internal work unit environment subscale..... 215
Table 5.29	Unstandardised factor loading matrix ( $\Lambda X$ ) for the analyses and understands the external and internal work unit environment measurement model..... <b>Error! Bookmark not defined.</b>
Table 5.30	Completely standardised factor loading matrix ( $\Lambda X$ ) for the analyses and understands the external and internal work unit environment measurement model..... <b>Error! Bookmark not defined.</b>
Table 5.31	Unstandardised measurement error variance matrix ( $\Theta\delta$ ) for the analyses and understands the external and internal work unit environment measurement model..... <b>Error! Bookmark not defined.</b>
Table 5.32	Completely standardised measurement error variance matrix ( $\Theta\delta$ ) for the analyses and understands the external and internal work unit environment measurement model ..... <b>Error! Bookmark not defined.</b>
Table 5.33	R2 values for the analyses and understands the external and internal work unit environment measurement model..... <b>Error! Bookmark not defined.</b>
Table 5.34	Item analysis output for the creates an exciting and aspirational vision for the unit subscale.....219
Table 5.35	PRELIS test of multivariate normality output for the creates an exciting and aspirational vision for the unit subscale.....220
Table 5.36	Unstandardised factor loading matrix ( $\Lambda X$ ) for the creates an exciting and aspirational vision for the unit measurement model.....222
Table 5.37	Completely standardised factor loading matrix ( $\Lambda X$ ) for the creates an exciting and aspirational vision for the unit measurement model .....222
Table 5.38	Unstandardised measurement error variance matrix ( $\Theta\delta$ ) for the creates an exciting and aspirational vision for the unit measurement model.....223
Table 5.39	Completely standardised measurement error variance matrix ( $\Theta\delta$ ) for the creates an exciting and aspirational vision for the unit measurement model....223
Table 5.40	R2 values for the creates and exciting and aspirational vision for the unit measurement model .....224
Table 5.41	Item analysis output for the entrenches a high-performance culture in the unit subscale .....225
Table 5.41	Item analysis output for the entrenches a high-performance culture in the unit subscale (continued)..... <b>Error! Bookmark not defined.</b>

Table 5.42	PRELIS test of multivariate normality output for the entrenches a high-performance culture in the unit subscale.....	226
Table 5.43	Unstandardised factor loading matrix ( $\Lambda$ ) for the entrenches a high-performance culture in the unit measurement model.....	227
Table 5.44	Completely standardised factor loading matrix ( $\Lambda$ ) for the entrenches a high-performance culture in the unit measurement model.....	228
Table 5.45	Unstandardised measurement error variance matrix ( $\Theta\delta$ ) for the entrenches a high-performance culture in the unit measurement model.....	229
Table 5.46	Completely standardised measurement error variance matrix ( $\Theta\delta$ ) for the entrenches a high-performance culture in the unit measurement model.....	229
Table 5.47	R2 values for the entrenches a high-performance culture in the unit measurement model .....	229
Table 5.48	Item analysis output for the develops unit competitiveness subscale.....	230
Table 5.49	PRELIS test of multivariate normality output for the develops unit competitiveness subscale.....	232
Table 5.50	EFA Pattern matrix for the develops unit competitiveness subscale .....	233
Table 5.51	Unstandardised factor loading matrix ( $\Lambda$ ) for the two-factor develops unit competitiveness measurement model.....	235
Table 5.53	Unstandardised measurement error variance matrix ( $\Theta\delta$ ) for the two-factor develops unit competitiveness measurement model.....	236
Table 5.54	Completely standardised measurement error variance matrix ( $\Theta\delta$ ) for the two-factor develops unit competitiveness measurement model.....	236
Table 5.55	R2 values for the develops unit competitiveness two-factor measurement model .....	237
Table 5.56	Unstandardised indirect effects of the second-order factor on the develops unit competitiveness subscale items .....	239
Table 5.57	Item analysis output for the involves others and elicits participation subscale	240
Table 5.58	PRELIS test of multivariate normality output for the involves others and elicits participation subscale .....	241
Table 5.59	Unstandardised factor loading matrix ( $\Lambda$ ) for the involves others and elicits participation measurement model.....	243
Table 5.60	Completely standardised factor loading matrix ( $\Lambda$ ) for the involves others and elicits participation measurement model .....	243
Table 5.61	Unstandardised measurement error variance matrix ( $\Theta\delta$ ) for involves others and elicits participation measurement model.....	244
Table 5.62	Completely standardised measurement error variance matrix ( $\Theta\delta$ ) for the involves others and elicits participation measurement model.....	244
Table 5.63	R2 values for the involves others and elicits participation measurement model .....	245
Table 5.64	Item analysis output for the unites and connects followers subscale.....	246

Table 5.65	PRELIS test of multivariate normality output for the unites and connects followers subscale.....	247
Table 5.66	EFA Pattern matrix for the unites and connects followers subscale .....	248
Table 5.67	Unstandardised factor loading matrix ( $\Lambda X$ ) for the two-factor unites and connects followers measurement model.....	250
Table 5.68	Completely standardised factor loading matrix ( $\Lambda X$ ) for the two-factor unites and connects followers measurement model.....	251
Table 5.69	Unstandardised measurement error variance matrix ( $\Theta\delta$ ) for the two-factor unites and connects followers measurement model .....	251
Table 5.70	Completely standardised measurement error variance matrix ( $\Theta\delta$ ) for the two-factor unites and connects followers measurement model.....	252
Table. 5.71	R2 values for the two-factor unites and connects followers measurement model .....	252
Table 5.72	Unstandardised indirect effects of the second-order factor on the unites and connects followers subscale items .....	254
Table 5.73	Item analysis output for the strengthens and enables followers subscale.....	255
Table 5.74	PRELIS test of multivariate normality output for the strengthens and enables followers subscale.....	256
Table 5.75	Unstandardised factor loading matrix ( $\Lambda X$ ) for the strengthens and enables followers measurement model.....	257
Table 5.76	Completely standardised factor loading matrix ( $\Lambda X$ ) for the strengthens and enables followers measurement model.....	258
Table 5.77	Unstandardised measurement error variance matrix ( $\Theta\delta$ ) for strengthens and enables followers measurement model.....	258
Table 5.78	Completely standardised measurement error variance matrix ( $\Theta\delta$ ) for the strengthens and enables followers measurement model.....	258
Table. 5.79	R2 values for the strengthens and enables followers measurement model.....	259
Table 5.80	Item analysis output for the manages the internal work unit environment subscale .....	260
Table 5.81	PRELIS test of multivariate normality output for the manages the internal work unit environment subscale .....	261
Table 5.82	EFA Pattern matrix for the manages the internal work unit environment subscale .....	262
Table 5.83	Unstandardised factor loading matrix ( $\Lambda X$ ) for the two-factor manages the internal work unit environment measurement model.....	264
Table 5.84	Completely standardised factor loading matrix ( $\Lambda X$ ) for the two-factor manages the internal work unit environment measurement model.....	265
Table 5.85	Unstandardised measurement error variance matrix ( $\Theta\delta$ ) for the two-factor manages the internal work unit environment measurement model.....	265

Table 5.86	Completely standardised measurement error variance matrix ( $\Theta\delta$ ) for the two-factor manages the internal work unit environment measurement model.....	265
Table 5.87	R <sup>2</sup> values for the manages the internal work unit environment measurement model.....	266
Table 5.88	Unstandardised indirect effects of the second-order factor on manages the internal work unit environment subscale items .....	268
Table 5.89	PRELIS tests of univariate normality for the PGLCQ item parcels.....	273
Table 5.90	PRELIS test of multivariate normality for the PGLCQ item parcels.....	273
Table 5.91	Basket of goodness of fit statistics for the PGLCQ Competency Questionnaire Measurement Model.....	275
Table 5.92	Summary statistics for the standardised residuals for the PGLCQ measurement model.....	276
Table 5.93	Modification indices for the factor loading ( $\lambda$ -X) matrix.....	279
Table 5.94	Modification indices for the measurement error variance-covariance ( $\theta$ - $\delta$ ) matrix.....	279
Table 5.95	Unstandardised $\lambda$ -X matrix for the PGLCQ measurement model .....	282
Table 5.96	Completely standardised $\lambda$ -X matrix for the PGLCQ competency questionnaire measurement model.....	283
Table 5.97	R <sup>2</sup> values for the items parcels of the PGLCQ measurement model .....	284
Table 5.98	Unstandardised measurement error variance-covariance ( $\theta$ - $\delta$ ) matrix for the PGLCQ measurement model .....	285
Table 5.99	Completely standardised $\theta$ - $\delta$ matrix for the PGLCQ competency questionnaire measurement model.....	285
Table 5.100	Phi matrix for the PGLCQ competency questionnaire measurement model .....	288
Table 5.101	95% confidence interval for sample phi estimates .....	289
Table 5.102	Squared sample phi estimates and average variance extracted per latent variable .....	289
Table 5.103	Basket of goodness of fit statistics for the comprehensive graduate leader performance LISREL model .....	294
Table 5.104	Hu and Bentler's (1999) Two-index presentation strategy combination rules.	299
Table 5.105	Summary statistics for the standardised residuals of the comprehensive LISREL model.....	300
Table 5.106	Unstandardised beta matrix for the graduate leader performance structural model.....	305
Table 5.107	Unstandardised gamma matrix for the graduate leader performance structural model.....	306
Table 5.108	Completely standardised beta matrix for the graduate leader performance structural model .....	308



Table 5.109	Completely standardised gamma matrix for the graduate leader performance structural model .....	308
Table 5.110	R <sup>2</sup> values for the endogenous latent variables of the graduate leader performance structural model.....	309
Table 5.111	Unstandardised psi matrix for the graduate leader performance structural model .....	310
Table 5.112	Completely standardised psi matrix for the graduate leader performance structural model .....	311
Table 5.113	Modification indices for the beta matrix.....	312
Table 5.114	Modification indices for the gamma matrix .....	312
Table 6.1	The second-order competencies of the graduate leader performance construct .....	323
Table 6.2	McDonald's omega coefficients for the single-factor PGLCQ subscales.....	324
Table 6.3	Stratified alpha coefficients for the two-factor (composite) PGLCQ subscales..	324
Table 6.4	Matching competency acquisition with succession planning and job rotations: Industry application .....	342

## LIST OF FIGURES

Figure 1.1	Elements of Employee Performance .....	4
Figure 2.1	Distinguishing competency potential and competencies as two different domains of a competency model .....	32
Figure 2.2	A graphical representation of a chain of cause-and-effect relationships between variables mapped in a 3-domain competency model.....	33
Figure 2.3	A five-domain representation of a competency model.....	34
Figure 2.4	The Job Demands-Resources model.....	36
Figure 2.5	A five-domain representation of a competency model (full version).....	38
Figure 2.6	The construct of job performance conceptualised as a partial competency model embedded in a comprehensive competency model.....	42
Figure 2.7	A graphical representation of learning in a classroom/programme setting.....	45
Figure 2.8	A graphical representation of action/experiential learning.....	45
Figure 2.9	Integrated leadership strataplex and graduate leadership transitions schematics .....	53
Figure 2.10	A simplified representation of the organisation as an open system.....	55
Figure 2.11	The Balanced Scorecard approach to strategic performance management .....	63
Figure 2.12	A graphic representation of shared team mental models .....	77
Figure 2.13	Maslow's hierarchy of needs: Six stage version.....	84
Figure 2.14	The Competing Values Framework.....	89
Figure 2.15	Graduate leader performance structural model (behavioural component) imposed on the Leadership Strataplex schematics .....	117
Figure 2.16	Graduate leader performance structural model imposed on the Leadership Strataplex schematics.....	118
Figure 3.1	The research framework.....	121
Figure 3.2	Graduate leader competency domain structural model imposed on the Leadership Strataplex schematics with LISREL notation added.....	126
Figure 3.3	The research design logic to test operational hypotheses 1-5 .....	129
Figure 3.4	The research design logic to test operational hypotheses 6-7 .....	129
Figure 3.5	Likert scale format utilised in scaling the salience of second-order graduate leader competencies .....	138
Figure 3.6	Likert scale format for experimental items in the PGLCQ that measures proficiency on the develops unit competitiveness second-order graduate leader competency.....	144
Figure 3.7	The multi-rater CFA (CCCR) PGLCQ model.....	158
Figure 3.8	An illustrative MTMM matrix. ....	159

Figure 3.9	Illustration of the Composite Direct Product model.....	163
Figure 3.10	Revised ex post facto correlational design used to evaluate the PGLCQ measurement model .....	164
Figure 5.1	First-order displays personal leader proficiency measurement model (completely standardised solution).....	210
Figure 5.2	First-order analyses and understands the external and internal work unit environment measurement model (completely standardised solution) .....	216
Figure 5.3	First-order creates an exciting and aspirational vision for the unit measurement model (completely standardised solution).....	221
Figure 5.4	First-order entrenches a high-performance culture in the unit measurement model (completely standardised solution).....	227
Figure 5.5	First-order develops unit competitiveness measurement model (completely standardised solution) .....	232
Figure 5.6	First-order two-factor develops unit competitiveness measurement model (completely standardised solution).....	234
Figure 5.7	Second-order two-factor develops unit competitiveness measurement model (completely standardised solution).....	238
Figure 5.8	First-order involves others and elicits participation measurement model (completely standardised solution).....	242
Figure 5.9	First-order single-factor unites and connects followers measurement model (completely standardised solution).....	248
Figure 5.10	First-order two-factor unites and connects followers measurement model (completely standardised solution).....	250
Figure 5.11	Second-order two-factor unites and connects followers measurement model (completely standardised solution).....	253
Figure 5.12	First-order strengthens and enables followers measurement model (completely standardised solution) .....	256
Figure 5.13	First-order manages the internal work unit environment measurement model (completely standardised solution).....	262
Figure 5.14	First-order two-factor manages the internal work unit environment measurement model (completely standardised solution).....	264
Figure 5.15	Second-order two-factor manages the internal work unit environment measurement model (completely standardised solution) .....	267
Figure 5.16	Representation of the PGLCQ measurement model (completely standardised solution) .....	274
Figure 5.17	Stem-and-leaf plot of the standardised residuals for the PGLCQ measurement model.....	276
Figure 5.18	Q-plot for the PGLCQ measurement model .....	277
Figure 5.19	Representation of the comprehensive graduate leader performance LISREL model (completely standardised solution).....	294

Figure 5.20	Stem-and-leaf plot of the standardised residuals for the comprehensive graduate leader performance LISREL model .....	300
Figure 5.21	Q-plot for the comprehensive graduate leader performance LISREL model .....	301
Figure 5.22	The graduate leader performance final structural model .....	315
Figure 6.1	A simplified representation of the organisation as an open system .....	320
Figure 6.2	Operationalised graduate leader competency domain structural model imposed on the Leadership Strataplex schematics .....	321
Figure 6.3	Support for the attributed internal structure of the graduate leader performance construct with effect sizes .....	328
Figure 6.4	The internal structure of the graduate leader performance construct as measured by the PGLCQ .....	336

## **CHAPTER 1:**

### **BACKGROUND AND RESEARCH OBJECTIVES**

#### **1.1 INTRODUCTION**

In order for a country to be prosperous in a competitive global environment, it must demonstrate high and consistent economic growth. The capacity to produce and deliver high levels of goods and services in a country for internal consumption and exportation to other countries expands the size of its economy and strengthens its fiscal condition through enhanced production capacity and purchasing power (Soyer, Ozgit, & Rjoub, 2019). Economic growth also lays the foundation for progress and advancement in that it increases overall income per capita, creates more jobs and has a positive impact on business confidence, and consequently, investment within that country. As countries grow richer, they have more resources available to invest in cleaner technologies and to tackle research and social (welfare) development agendas that have additional benefits for society as a whole. Economic growth is therefore typically synonymous with a higher standard of living in a country (Wesley & Peterson, 2017). The vehicle through which economic growth is achieved in a country, is through the organisations and people that operate within them (Pelinescu, 2015; Wilson & Broscoe, 2004). That is to say that economic growth is achieved when people and resources are grouped together into organisations that effectively and efficiently transform resource inputs into product outputs in the form of finished goods and services with economic utility (Schermerhorn, 2006). For organisations to perform well and to satisfy their shareholders and customers real value must be created and this can only be done when an organisation operates productively and efficiently – i.e. when resources are utilised in the right way, at the right time, and at minimum cost (Haller, 2012; Schermerhorn, 2006). Within this context then, it can be said that the goal of organisations is economic productivity – to effectively and efficiently create economic value for shareholders, customers and the broader community.

As “most organisations today can copy technology, manufacturing processes, products and strategy” (Burke, Cary, & Cooper, 2006, p. 3) and can access the same capital markets and buy physical resources on the open market with relative ease (Rothaermel, 2013), it is becoming increasingly clear that “human resources are the only dynamic production factor an organisation has” (Schermerhorn, 2006, p. 6) through which to identify and commercialise white space that can be used to leverage competitive advantage (Mathur, 2015). Resources such as capital, raw materials and machinery remain important, but they are static and imitable (and in the case of South Africa limited and not sufficiently technologised) and it is the optimal utilisation of human resources in particular which activates these other resources (Werner, Du Plessis, Ngalo, Poisat, Sono, van Hoek, & Botha, 2011). There is therefore a causal relationship between the success of an organisation and the utilisation of its human resources (Crocker & Eckardt, 2014; Boxall & Purcell, 2016) as the value creation processes in organisations are largely dependent on humans as the carriers of the production factor of labour. That is to say that human resources are and will be the differentiating factor with regards to future competitiveness as their performances in the workplace cannot be replicated very easily (Mattone & Xavier, 2013) and are not the outcome of a random event. Rather, superior employee performance is the result or manifestation of a complex nomological net of various interrelated factors that include but are not limited to the personalities, intelligence, attitudes and individual characteristics of the people employed in a business. Also, it can be said that properly designed and implemented human resource systems can positively affect the characteristics of the people employed in the organisation as well as the contexts in which they operate, which in turn affects the behaviour of people as well as the outcomes achieved in the workplace. As it is extremely difficult to replicate conditions that bring

about performance levels that outshine those of competitors and that provide organisations with competitive advantage (Amos, Ristow, Ristow & Pearse, 2008) it is imperative to take notice of theories, models and methodologies for getting the best out of people. However, “despite peoples’ interest in understanding what managing people involves, and the ever-increasing amount of information and knowledge available to us, the enduring paradox is that many... managers ... find the challenge difficult and frustrating” (Banfield & Kay, 2008, p. 4).

South Africa’s ability to compete successfully in the global market appears to be wanting and we do not currently compare well in relation to our international counterparts. In short, it appears that our organisations are also finding the people management challenge difficult and frustrating. South Africa’s economic performance is currently ranked at number 60 out of 141 countries in the world in terms of the World Economic Forum’s Global Competitiveness Report (2019). That is to say that more than 40 percent of the world’s countries are currently outperforming South Africa in terms of economic performance, or to put it differently, more than 40 percent of the world’s companies are more productive in the use of available resources (including specifically their human resources) than the organisations operating in our country. This problem is of course exacerbated by many other challenges the country is facing such as very low levels of basic infrastructure (i.e. access to safe drinking water and sanitation, deteriorating road and freight systems, etc.), climate change (i.e. drought that influences agriculture output), the unproductive structure of the economy (i.e. low-end services dominate, much of them in the informal services domain), untapped opportunities in technology, electricity generation, the expansion of the communication networks and access to financial services institutions, and a slow transition to a more productive population structure with a larger working age population in relation to the number of dependents (Cilliers, 2020). The challenge for South African organisations is therefore to increase their productivity via the efficient use of their resources, specifically their human resources as this is an aspect that industry can more directly exercise control over and focus on in the short-term, and this means that South Africa has to make sure that the right competencies are available in their organisations at the right time. This challenge can be met through the employment of Human Resource Management as a behavioural science as one solution to address the productivity problem, which has provided practitioners with many new models, concepts, theories and processes that are utilised effectively in numerous corporations (Chanda, Krishna, & Shen, 2007; Igwe, Onwumere, & Egbo, 2014) to maximise both employee as well as organisational effectiveness.

## **1.2 HUMAN RESOURCE MANAGEMENT AS A KEY DRIVER OF PERFORMANCE**

Jobs exist to achieve specific outcome variables. The extent to which employees achieve the outcomes for which the job exists depends on the level of competence that they achieve on specific behavioural competencies (Bartram, 2005). The performance of employees could therefore be evaluated in terms of the success with which they realise the outcomes for which the job exists through the appropriate employment of the correct competencies. The success with which these outcomes are realised, however, depends not only on the level of competence they achieve on the behavioural competencies that are instrumental in the achievement of the outcomes, but also to some degree on factors that lie outside the influence of the employee. To the extent that situational characteristics facilitate or inhibit the achievement of the outcome variables, outcome measures of job performance will be contaminated. Summative performance appraisal based only on an assessment of the degree of success with which outcomes are achieved may therefore be unfair. Preference is therefore typically given to summative performance appraisal based on the assessment of the level of competence achieved on the behavioural competencies that are instrumental in the achievement of the outcomes. When viewed from the perspective of formative (rather than summative) performance appraisal and when viewed from the perspective of the development of a comprehensive performance theory, however, a more comprehensive conceptualisation of job performance would be achieved if the manner in which structurally interrelated behavioural competencies affect structurally interrelated outcome

variables could be formally modelled as a performance structural model (Myburgh, 2013). Performance levels of employees thus defined are assumed to be determined by a complex nomological net of latent variables characterising the employee and characterising the organisational context. It is the goal of behavioural science to attempt to “uncover”<sup>1</sup> and describe the latent variables that make up this net, and also how these latent variables are structurally linked to each other, without which the Human Resources profession would be relatively helpless in their attempts to enhance employee performance via a range of Human Resource interventions.

Over the years, there have been many definitions of Human Resource Management (HRM). For example, Beer, Spector, Lawrence, Quinn Mills, & Walton (1984, p. 1) define human resources management as a process that “involves all management decisions and actions that affect the relationship between the organisation and its employees – its human resources”, while Cascio (1998, p. 1) defines Human Resource Management as the “attraction, selection, retention, development and use of human resources in order to achieve both individual and organisational objectives.” Amos et al. (2008, p. 8) in turn defines HRM as “the system of philosophies, policies, programmes, practises and decisions that affect the attitudes, behaviour and performance of the people of an organisation so that people are satisfied, perform, and contribute to the organisation, achieving its objectives”, while Lazarova and Thomas (2014, p. 2) conceptualised HRM as consisting “of the activities, policies, and practices of *attracting, engaging, developing and retaining* the employees that an organisation needs to accomplish its goals. In a sense then a Human Resource Management system comprises of different people management practices aimed at regulating the flow of talent into the organisation, keeping talent in the organisation, developing the talent, and optimally utilising the talent towards individual and organisational performance. In this regard, several researchers (Boudreau, Milkovich, & Milkovich, 2008; Boxall & Purcell, 2008; Subramony, 2009) have suggested the grouping of HR interventions. Boxall and Purcell (2008), Lepak, Liao, Chung, & Harden (cited in Martocchio, 2006) and Subramony (2009) argue that HR systems operate through influencing the employees’ abilities to perform, motivation to perform, and opportunities to perform.

Boudreau et al. (2008) in turn, argue that a distinction can be made between HR interventions aimed at improving employee performance by regulating the flow of employees into, through and out of the organisation and interventions aimed at improving employee performance by altering the characteristics of current employees (i.e. current stock) in their current positions. The former typically focuses on non-malleable latent variables characterising the employee whereas the latter typically focuses on malleable latent variables characterising the employee and the organisational context. However, regardless of how HR interventions are grouped and over and above the fact that the grouping of HR activities makes it easier to explain the broad functions of the HR department, the notion is also based on the “conceptual logic of performance” (Jiang, Lepak, Han, Hong, Kim, & Winkler, 2012, p. 73) – i.e. employee performance is often viewed as a function of three broad components, namely dispositions and attainments (Bartram, 2005) that enable employees to perform, psychological states<sup>2</sup> that motivate employees to perform, and

---

<sup>1</sup> It is acknowledged that the nomological network does not exist in a physical sense. Strictly speaking there is thus nothing to uncover. The latent variables comprising the nomological net are intellectual constructions created by man’s abstract thinking capacity to describe and explain variance in employee performance. Hypotheses developed in terms of these intellectual constructions on the psychological mechanism regulating differences in performance levels may be considered a valid (i.e. permissible) explanation if inferences derived from the hypothesis are compatible with empirical observations made.

<sup>2</sup> Dispositions and attainments that enable employees to perform and psychological states that motivate employees to perform can collectively be termed **competency potential latent variables**. Dispositions are relatively stable and permanent attributes of people, developed over a long period of time, whilst attainments represent more malleable acquired knowledge, and crystallised abilities via learning opportunities encountered throughout life in various settings/scenarios. A psychological state is a “state of being” (Manetje & Martins, 2009, p. 92) which guides employees’ actions and is comprised of feelings, beliefs, and behavioural inclinations (Ajzen, 2001; Ajzen & Fishbein, 1980; Allen & Meyer, 1990; Eagly & Chaiken, 1993).

situational variables that permit employees to perform. In order to maximise employee performance then, HR practices could be viewed as interventions that influence one of the three primary HR domains:

1) the dispositions and attainments domain,<sup>3</sup> 2) the motivation and effort domain, and 3) the opportunities to contribute domain (Lepak et al., cited in Martocchio, 2006). People management practices such as recruitment and selection, and training and development fall within the dispositions and attainment domain; performance management, remuneration and reward fall within the motivation and effort domain, and job design and employee engagement interventions fall within the opportunities to contribute domain. People management practices such as recruitment and selection, promotion and replacement represent examples of flow interventions, whereas performance management, training and development, and job enrichment represent examples of stock interventions. The HR intervention taxonomy is displayed in Figure 1.1.

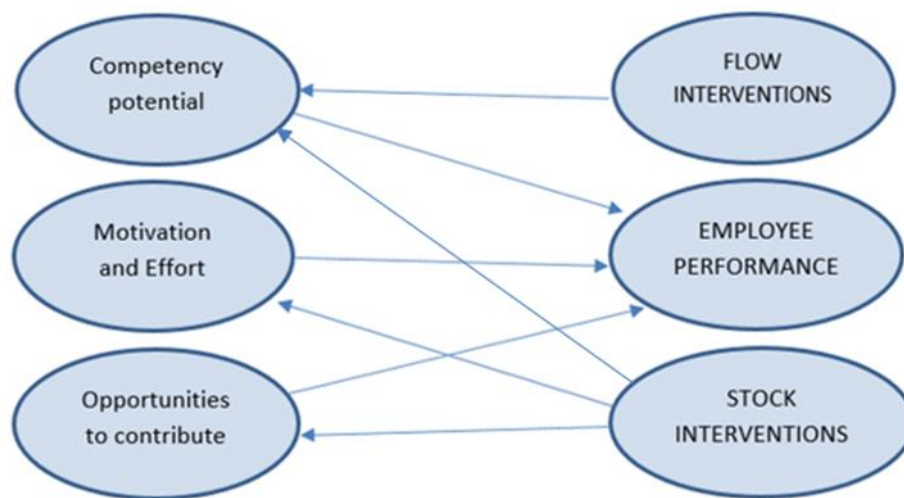

Figure 1.1. *Elements of employee performance*

The application of different people management processes should, however, not be done in isolation. “HR practices work in concert” with each other and employees are exposed to multiple processes simultaneously (Jiang et al., 2012, p. 73). The underlying idea here is to achieve synergy, and for the HR function to contribute more to employee performance as an integrated whole than the sum of a number of independent, separate interventions. Therefore, for an organisation to elicit top performance from their people, an effective Human Resources Management system has to be aligned with organisational strategy and it needs to demonstrate optimal synergy between its people management practices.

The need for a coherent, integrated ‘orchestra’ of HR interventions arises from the fact that, although employee performance can permissibly be viewed as a function of the three aforementioned broad domains of variables, interventions in the final analysis need to be informed by the complex nomological net of latent variables underpinning performance. The nomological network is complex in the sense that malleable and non-malleable variables characterising employees and malleable (and possibly non-malleable) variables characterising the organisational context are structurally and richly interconnected. As a consequence, the explanation for employee performance is not located in any individual latent variable or

<sup>3</sup> Lepak et al. (cited in Martocchio, 2006) interpret this domain as representing the knowledge, skills and abilities necessary to perform. This is regarded as too narrow an interpretation. The extent to which an employee is able to display competence on the competencies that constitute the performance construct depends not only on knowledge, skills and abilities but also on dispositions like personality and aptitude.



structural linkage but rather spread across the whole of the net (Cilliers, 1998). Attempts to influence performance (both proactively and reactively) therefore need to target numerous latent variables in the net simultaneously via the appropriate HR intervention. Moreover, the collective attempt to improve employee performance has to take the nomological net as the point of departure, and not the array of possible HR interventions.

### **1.3 THE FUTURE: GENERATION Y GRADUATES AND THE HUMAN RESOURCES DEPARTMENT**

It can be said that one influential group of employees that the Human Resources Department is responsible for is graduates, and just like other groups of employees, energy and time needs to be invested to attract, select, develop, and engage this specific cohort or generation of individuals. "Generation Y is the (most popular) name given to the most recent demographic group to have entered higher education and the world of work" (Fairhurst & Shaw, 2008, p. 367). This generation has also been labelled the Millennials, the Net Generation, the Dot-coms, the Echo-boomers, the Me Generation (Eisner, 2005), the Nexters or the Nexus generation (Barnard, Cosgrove, & Welsh, 1998). These are individuals who were born between 1977 and 1994 and who have perspectives that differ sharply from previous generations (Weiss, 2003). Apart from differing perspectives, they also often look quite different than previous generations with body piercings, tattoos and electronic adornments such as iPods, smartphones and laptops (Hira, 2007).

As the latest generation to enter the workforce, Generation Y is the "most technically literate, educated and ethnically diverse generation in history" (Eisner, 2005, p. 6). It is also the largest generation to ever enter the workforce (Luscombe, Lewis, & Biggs, 2012) and there is growing consensus that 'Gen Y' differs from previous generations in terms of their work-related characteristics (Fairhurst & Shaw, 2008). Policies and methods used previously to secure the best candidates from previous generations are therefore likely to be relatively ineffective with Generation Y (Lindquist, 2008). For example, Generation Y individuals are emotionally needy and constantly seek approval and praise (Crumpacker & Crumpacker, 2007), they demand freedom and flexibility to get the task done their own way and at their own pace (Martin, 2005), and they are results-orientated and have an appetite for work and pressure (Shih & Allen, 2007). They also have an expectation that they will change jobs frequently and this means they actively seek jobs that provide training (Morton, 2002), and they perceive challenging and meaningful assignments to be far more important for their development than lifelong employment (Baruch, 2004). This expectation might be based on them having seen their parents making many work-related sacrifices, only to fall victim to corporate downsizing, high divorce rates, etc. resulting in them being less willing to put in the same effort without any direct or immediate benefits (Loughlin & Barling, 2001).

The unique characteristics of this generation of employees "have significant implications for the design of organisations and work groups in order to meet the needs of these younger workers" (Yrle, Hartman, & Payne, 2005, p. 189) and also to elicit the best performances from them in the workplace. This might also mean that conventional HR processes and approaches need to be refined in catering for this new generation that have what has been suggested as "supersized", "unrealistic" and "disconnected" expectations and goals between reward and performance (Ng, Schweitzer, & Lyons, 2010, p. 282) in the workplace. For example, it stands to argue that if Generation Y individuals have an expectation that they will change jobs frequently (Morton, 2002), HR departments will have to start putting systems in place that allow for incremental shifts in an individual's vertical and horizontal career paths. Similarly, if the pressing need for Generation Y individuals is to have flexibility and freedom with regards to how they complete their work tasks (Martin, 2005), it might be beneficial for HR departments to start thinking about ways in which the management approach in an organisation can be nurtured towards this end. Maybe, even more importantly, these actions might be seen by others in the organisation as a

form of preferential treatment for graduates and other younger employees, which in itself poses significant change and culture management challenges to the HR department and other senior managers. Indeed, “generational values, attitudes, and preferences may exist and can cause intergenerational misunderstanding, affect workplace dynamics and impede organisational culture change and effectiveness” (Fairhurst & Shaw, 2008, p. 376). In other words, conditions need to be created that will be conducive to high Generation Y performance without negatively impacting on the older generation employees’ performance.

In the end, the customisation of organisational characteristics to accommodate the needs of Generation Y individuals might pose something of a challenge to most organisations. However, as “these individuals’ post-graduate lives will significantly affect wider society, the economy and the political order as they start taking on influential roles in those domains” (Holmes, 2013, p. 540) the adoption of a tailored approach and the understanding of the unique perspectives, needs and expectations of this group and the resultant implications that these have on the development of strategies to attract, retain, and develop Generation Y employees (Fairhurst & Shaw, 2008; Jorgensen, 2003) might be beneficial. In fact, “the general school of thought asserts that organisations must recognise the influence and work preferences of different generations to be effective in the future” (Fairhurst & Shaw, 2008, p. 366), which in effect prompts HR departments to start thinking about how they can best acquire, select, develop, and nurture Generation Y for optimal performance in the work environment.

## **1.4 GRADUATES AND THE DISPOSITIONS AND ATTAINMENTS DOMAIN**

### **1.4.1 GRADUATE EMPLOYABILITY**

As mentioned above, one of the HR department’s primary functions is to improve performance by optimising the dispositions and attainments that enable employees to display capability on the competencies that comprise job performance. This includes but is not restricted to the knowledge, skills and abilities of the employee base in the organisation. In this regard, one theme in particular that has become increasingly important to Human Resource departments, organisations, and indeed countries as a whole is that of graduate employability.

The salience of graduate employability stems from global findings that support a discrepancy between what is expected from employers and what is produced by institutions of higher learning in terms of generic or core skills that are believed to be fundamental to a modern graduate’s successful transition into the workplace. In other words, employers these days expect, apart from academic capabilities and degrees, and given new organisational and technological work models that have evolved (e.g. lean production, internally flexible organisation, the learning organisation, etc.) which impose fundamental shifts in the working competencies required by the traditional organisation, that graduates should display ability on competencies not directly related to functional (or vocational) task competencies that will facilitate prompt and successful transition from higher education (Holmes & Miller, 2000). Many young graduates lack competence on these more generic competencies.

To illustrate this aforementioned global trend, a survey conducted by Archer and Davison (2008) on graduate employability for the Council for Industry and Higher Education in the UK indicated that almost a third of participating graduate employers were not sufficiently satisfied with their graduates’ generic competencies such as teamwork, communication and problem-solving. Likewise, across nine countries<sup>4</sup> that were surveyed as part of a report for the McKinsey Center for Government, only 43% of participating employers agreed that they could find enough skilled entry-level workers (Mourshed, Patel, & Suder, 2014) to satisfy their manpower requirements. The declining state of the employability of graduates globally is also mirrored in over-educational

---

<sup>4</sup> Companies from Brazil, Germany, India, Mexico, Morocco, Turkey, Saudi Arabia, the United Kingdom and the United States participated in the study.

mismatch data in the United States and Canada, according to which many graduates are progressively assigned to jobs that require a lower level of formal education since the competency set that they bring to the work environment is misaligned with what is expected by the organisation (Leuven & Oosterbeek, 2001; Sloane, 2002; The European Centre for the Development of Vocational Training [CEDEFOP], 2010). “This phenomenon has greatly increased in the last 20 years, rising from an average of 24% in the penultimate decade to 39% in the last decade, reaching a pathological level of around 30% in Europe and 40% in the USA and Canada” (Leuven & Oosterbeek, 2001, p. 16). Many countries have responded to this challenge by investigating industry requirements and attempting to build the appropriate competency acquisition strategies into their systems of higher education. In New Zealand, for example, remedial measures have been developed in consultation with education and industry specialists such as the National Qualifications Framework (NQF). In Canada, many universities have introduced a critical skills framework into their careers programmes to better prepare their students for entry into the Canadian workforce. Finally, in Denmark, a qualifications framework has been developed that requires students to complete a competence profile in addition to academic work (Cranmer, 2006) as part of the graduation process.

With regard to the exact set of transferable competencies required to elevate levels of graduate employability, no single list emerges from the literature as the definitive authority on the matter. However, certain similarities exist between the lists brought forward by many authors. For example, according to Bennet, Dunne and Carré (2000), graduate employability competencies include written, oral, and interpersonal communication, problem-solving, self-management, and computer literacy. More recently, a 2009 survey of chief executives in Australia identified the competency areas of communication, teamwork, problem-solving, initiative, planning and organising, self-management, and learning and technology as key considerations in graduate employability (Huq & Gilbert, 2013). Osmani, Weerakkody, Nitham, Esmail, Eldabi, Kapoor, and Irani (2015) summarised the findings of various graduate employability studies to date to produce a list of the most prominent competencies required in this regard that makes mention of the competency areas of communication, technology, teamwork, self-management, leadership, critical thinking, research, planning, and organising and time-management.

It can be argued that the deficiencies mentioned above all relate to a general inability among graduates to have mastered the process of learning through which prior learning is transferred to find meaningful structure in initially meaningless learning material or problems and to internalise the created structure (so that it becomes available for subsequent transfer in new, novel settings). The concern is therefore that graduates passively memorise learning material – i.e. the phenomenon of acquiring (someone else’s) “reconstructed understanding” instead of learning by “understanding in use” (Coghlan, 2013, p. 55). The problem is that such memorised learning material is of no value in solving novel problems. It can only be repeated on cue. Industry is, however, not interested in recitals of previously memorised learning material. It is interested in creative, innovative problem-solving and the exploitation of opportunities. For tertiary education to be of value to industry, classroom learning should be characterised by true transfer and automatisation (Taylor, 1989; 1992; 1994; 1997) that expands existing knowledge structures and makes it available for subsequent transfer onto the novel problems that the graduate will face in industry. That is to say that competencies such as problem-solving, self-management and critical thinking essentially constitute transfer and therefore the extent to which the graduate will excel at it will depend on the extensiveness of the internalised, automated knowledge structure developed through transfer and automatisation during their tertiary studies. Learning is therefore not a process that is restricted to (and ends at) the tertiary educational classroom but it is a lifelong, never-ending process in which learning is achieved in increments through true transfer, action, experimentation and internalisation. Conceptualised in this way, learning then does not take place by simply memorising material presented by another individual and given the statistics presented on graduated employability, the concern exists that many graduates are falling in this trap of “reactive” learning. “A body of knowledge on its own does not constitute expertise. Only

when that knowledge is able to be applied in a work context does it contribute to competency” (Brunton & Jeffrey, 2010, p. 241).

The principles of action learning<sup>5</sup> seem particularly relevant in this discussion on graduate employability as in one popular conceptualisation of this practice, learning is conceptualised as an approach to problem-solving in real-life day-to-day situations (Argyris & Schön, 1996) that are based on the notion that participants best learn new behaviours (competencies) through real world issues (Bowerman, 2003; Conger, & Toegel, 2002). The practice is rooted in the assumptions that; 1) “situations are dynamic and never identical” (Coghlan, 2013, p. 55); 2) that learning is largely embedded in daily work or practice (Orlikowski, 2002); 3) that in order to progress beyond “programmed knowledge” (Revans, 1982, p. 13) a participant needs to critically reflect on learning via “double-loop learning<sup>6</sup>” (Argyris & Schön, 1996) or “know-how” learning which can only be gained from hands-on learning and experience” (Muhammed, 2012, p. 883); and that 4) this is best achieved by “real people resolving and taking action on real problems in real time and learning while doing so” (Marquardt, 2004, p. 1). In borrowing from the action learning paradigm then, the problems experienced with regards to graduate employability might therefore ultimately stem from an inability on the side of graduates to be able to create meaningful structure (internalisation) from transfer of prior knowledge (classroom instruction) onto new and novel situations, which could decrease their propensity to be able to “reshape” their learning experiences into the successful demonstration of competencies such as self-management and problem-solving in the new work environment.

A further reason for the graduate employability dilemma can be found in the work of van der Klink, Bültmann, Burdorf, Schaufeli, Zijlstra, Abma, Brouwer, and van der Wilt (2019) on *sustainable* employability. Drawing from the Capability Approach (CA) from Amartya Sen (Sen, 1985a; 1985b), these authors (van der Klink et al., 2019) contend that the world of work has changed to such an extent (i.e. job roles are becoming more autonomous, responsible and proactive as a result of technological advances and the increase of shared decision-making) that for many people work is now a life domain in which they can fulfil their ambitions and achieve their personal goals. Briefly, their idea is that people will be sustainably employable only if they succeed in converting resources into capabilities, and capabilities subsequently into work functioning, in such a way that important (aspirational) values such as recognition, meaning and security are met. Capability in this context is interpreted different than capacity, where capacity relates to physical properties or skills (including competencies) and capability is a more comprehensive idea that refers to all of the diverse aspects (i.e. physical properties and skills or competencies, material resources (ownership of and access to), facilitating conditions, freedom, etc.) relating to work functioning. This line of reasoning, in turn, broadens the diagnosis of the graduate employability problem to the possibility that 1) it stems not only from a lack of specific competencies (capacity) but also a lack of tangible opportunities (capabilities and freedom), 2) that not only personal (i.e. competency potential and competencies) factors must be considered in finding solutions to the graduate employability problem but that the environmental (work) conditions must be investigated for this purpose as well, and 3) researchers and practitioners should investigate what (values) Generation Y find more important and aspirational in order to ascertain whether graduates are truly *enabled* to be (sustainably) employable.

Regardless of what the exact mix of competencies is that needs to be institutionalised in developing more work-ready graduates as well as the reasons for the apparent shortfalls among graduates with regards to action learning and the implications of the CA approach to graduate

---

<sup>5</sup> Action learning represents a logical explanation for the acquisition of competency potential and competencies – e.g. competency derives from the interplay between domain content and the cognitive application of that same knowledge to a specific situation (Glaser, 1990).

<sup>6</sup> Double-loop learning is a concept originating from the action learning paradigm and “represents the deeper level of learning that is attainable by critically reflecting on the premises that underlie one’s understandings and beliefs” (O’Neil & Marsick, 2007, p. 188).

employability, it is important to note that South Africa is also facing graduate employability challenges. The pattern of mismatched expectations as discussed previously between the supply and demand of “employable” graduates is also evident in South Africa as indicated by the SAGEA (2014) Employers Survey. In this study, it was found that more than 20% of all graduate employers surveyed responded that despite a year-on-year increase in graduate vacancies since 2013, they were not able to fill all of their graduate vacancies<sup>7</sup> in 2014 as a result of applicants lacking the correct generic competencies. From this standpoint, the generic competencies deficit among graduates in South Africa is believed to be a hindering factor in the long-term economic growth of the country (Development Policy Research Unit [DPRU], 2006) as it is assumed that; 1) graduates lacking general “employability” skills will not easily get a job at a similar level in the future, (i.e. a graduate that lacks “generic competencies” and that has an extended period of unemployment after graduation is less likely to be employed) which effectively means a decrease in the pool of Generation Y graduates who can replace an ageing workforce; and 2) a loss of human capital required to successfully compete in the global market in terms of a smaller pool of candidates to feed manager and leader succession pools.

If Human Resource departments stand to lose out in this country and elsewhere if they cannot secure the services of employable graduates, it stands to reason that they should stop believing that the successful acquisition of employability skills predominantly remains the responsibility of universities (Hancock, Howieson, Kavanagh, Kent, Tempone, & Segal, 2009) and that they should get actively involved along with the government and institutions of higher education in this enterprise. A guideline for such involvement is provided by the government’s Strategic Plan of the Department of Higher Education and Training (2010/11-2104/2015) which calls for South African employers to consult with learning institutions in the development of more valid future curriculums, and also the provision of more valid Work Integrated Learning programmes for graduates. This type of strategy finds support from Pauw, Bhorat, Ncube, Oosthuizen, & van der Westhuizen (2006), who advocate an urgent need for broader and more intensive dialogue between employers in the industry and institutions of higher learning in the identification of curriculums to promote employability amongst graduates, and is also in line with current thoughts on employability as “many authors now argue that work-integrated learning (WIL) programmes of study combining classroom-based instruction with one or more periods of relevant experiential training in authentic work settings, provide the most effective means of developing graduate competencies” (Groenewald, 2003, p. 30). Scholarios, Lockyer and Johnson (2003) also highlight the vital role of work-based placements in leading to more effective induction and shorter periods of job training as well as more realistic expectations for graduates, thus supporting the notion that WIL programmes contribute to an easier work transition for graduates.

In the final analysis the issues surrounding graduate employability present a diagnostic problem to employers, institutions of higher education and governments as to why a too large a proportion of graduates fails to meet the expectations of their employers upon entry. The extensive inability of graduates to display adequate levels of competence on the behavioural competencies that comprise the job implies inappropriate levels in one or more of the latent variables in the nomological net of person latent variables and situational latent variables that determine performance. Remedial actions taken by the various stakeholders will be effective to the extent that the pathological latent variables in the nomological net are accurately diagnosed. As an example of one broad category of diagnostic hypotheses that would have to be investigated is that young employees and graduates do not have the necessary disposition and attainment set to equip them for the new world of work. An alternative hypothesis that could be investigated is that the situational latent variables entrenched in most organisational settings could be inherited from a vastly different generation than that of the younger Generation Y graduates, and that

---

<sup>7</sup> The largest number of graduate vacancies not filled was in the retail sector (25%), followed by Mechanical and Electrical Engineering (11-13%), and Auditing (6%).

consequently this could contribute to their transition struggle. The critical point to appreciate ultimately, is that a valid understanding of the nomological net of latent variables characterising the employee and the organisational context that determines the level of skill that graduates display on the competencies that constitute their job is a necessary prerequisite to successfully diagnose the causes of the employability problem and to proactively pursue graduate employability. Moreover, if graduates indeed are struggling to successfully transfer their institutional learning onto the novel applied problems that industry presents them with, and therefore competence on the behavioural competencies required by the world of work, then it will have to be recognised that learning competencies and the learning competency potential latent variables that determine the level of classroom learning as well as the level of subsequent experiential/action learning form an integral part of the nomological net that determines graduate job performance. In the end a deeper understanding of the nomological net of latent variables that constitute graduate performance and the latent variables characterising the graduate and the organisational context that determine graduate performance will better equip Human Resource professionals to start engaging in dialogue with institutions of higher learning on future curriculum development and to develop and facilitate programmes of work-integrated learning as two possible contributions to improve graduate transfer of learning and graduate employability in the country.

#### **1.4.2 ATTRACTION OF GRADUATES TO THE ORGANISATION**

The attraction of graduates is a prerequisite for successful selection efforts and properly devised attraction interventions on the side of HR can positively affect the performance levels of the organisation through its effect on the (graduate) base rate and selection ratio. If HR can entice the more employable graduates to apply and entice large numbers of them to apply the success ratio (i.e. the proportion of selectees that will eventually prove to be successful) will increase (Gatewood, Feild, & Barrick, 2008). However, the attraction of graduates can be problematic, as the “war for talent shows no sign of letting up” (Fernandez-Araoz, Graysberg, & Nohria, 2011, p. 76) and companies are competing for the attention of the next generation’s leaders and high potentials. Failure to become an employer of choice among young graduates or to be a popular option amongst Generation Y could result in a limited recruitment pool for future staffing and in high potential graduates applying at more prestigious and/or reputable companies.

The decision to apply or not to apply for a position in an organisation is complex and influenced by a number of factors. Over the past 50 years, researchers have examined a wide variety of possible predictors of applicant attraction (Chapman, Uggerslev, Carroll, Piasentin, & Jones, 2005). Amongst other things, job and organisational characteristics (such as pay, benefits, type of work, company size, company image, location, etc.) were found to be one factor in determining an applicant’s level of attraction to an organisation (Chapman et al., 2005). Another factor that has been proven to influence attraction to the organisation is that of perceived fit, where applicants are proposed to interpret characteristics of the job, the organisation, and the recruiter and to then determine to what extent these aspects relate to their own personal needs and values (Chapman et al., 2005). The underlying premise here is that “applicants develop perceptions of fit with organisations based on their values and identities, and will self-select themselves out of the recruitment process if they perceive a lack of fit” (Ng & Burke, 2005, p. 1198).

Other studies have highlighted the fact that recruiter characteristics as well as an applicant’s perceived alternatives and their expectations to be hired (Chapman et al., 2005) are also significant determinants in an applicant’s decision to apply at an organisation. Finally, related studies on the idea of a psychological contract that develops between the prospective employee and the employer might also be considered when investigating the attractiveness of certain organisations. Conceived as a schema that individuals hold about their employment exchange relationships (Rossouw, 2001), it “helps individuals to define what the employment relationship entails, and it guides the interpretation and recollection of promises exchanged during the employment relationship” (De Vos & Freese, 2011, p. 291).

Recently, and building on the above, the concept of an “employer brand” in the attraction of top candidates has gained prominence among many researchers and practitioners (Chapman et al., 2005; Edwards, 2010; Moroko & Uncles, 2008). That is to say that the “cultivation of an employer brand is one method top firms have chosen to secure and retain the most sought-after employees; those that will enable them to perpetuate their brand success and secure ongoing profitability” (Moroko & Uncles, 2008, p. 161). The concept of an employer brand has been named the “value proposition” (Martin, 2005) or the employer/employee value proposition (Barrow & Mosley, 2005) and “shares a theoretical foundation with both consumer and corporate branding” (Moroko & Uncles, 2008, p. 161).

The employer brand is the “package of functional, economic and psychological benefits provided by employment and identification with the company” (Moroko & Uncles, 2008, p. 6), and involves the identification of the unique employment experience offered by considering the totality of tangible and intangible reward features that an organisation offers to its employees (Edwards, 2010). In the end, the employer brand serves the function of communicating the organisation’s implicit employment promise that prospective employees consciously and subconsciously evaluate in deciding whether or not the particular organisation is an attractive employer option. Here the link with previous research done on aspects such as organisational characteristics, the psychological contract and person-job fit should become evident. The employer brand is the vehicle through which pertinent characteristics about an organisation is communicated via sophisticated marketing campaigns and used by “consumers” (i.e. prospective employees) to make decisions about how appealing it would be to work there (i.e. to ‘buy into the product/service’).

Maybe, even more importantly, it must be noted that organisations might have a tendency to emphasise positive or desirable values in official information material (such as recruitment brochures or on the company careers website) that might not necessarily be true which can create unrealistic expectations of the company culture (Cable & Graham, 2000). This could be because they want to lift their image as an employer of choice (among young graduates) or because they could be experiencing a lack of applications or a lack of quality applications. However, it is crucial that “employer branding messages should communicate accurate information about the culture” (Terjesen, Vinnicombe, & Freeman, 2007, p. 505) as the employee brand is intended to be a true representation of what an organisation offers to its employees (Sullivan, 2002). “Firms that emphasise unrealistic attributes will quickly be found out by new graduates who depart for other organisations which they perceive to have these attributes” (Terjesen et al., 2007, p. 517). This mismatch of expectations versus the reality of work-life in an organisation has been proven to lead to a wide variety of unsatisfactory work outcomes, of which high turnover is probably the most notable consequence (Luscombe et al., 2012). In the end, an employment brand with empty promises will result in graduates quickly leaving the organisation and probably negatively influence their willingness to act as advocates for the organisation in the future (Moroko & Uncles, 2008). In addition, the “churning of graduate employees constitutes a great cost to the firm in terms of lost time, morale and possibly customer trust and goodwill” (Terjesen et al., 2007, p. 517).

Despite the aforementioned definitions provided and discussion on employer branding, as well as some insights gained from the field of marketing science, very little theoretical and empirical work on this concept is available in the academic HR literature (Edwards, 2010), especially with regard to the attraction of graduates and Generation Y individuals. Many aspects still need clarification in order to be practically useful and to add theoretical substance to the field. For example, what are the attributes of a good employer brand? Is there a difference between, or should there be distinguished between, an employer brand and a graduate employer brand to cater for different generations of employees? What are the unique preferences of Generation Y individuals when it comes to perceived job-organisation fit or a psychological contract, and maybe even more importantly, even if these preferences are known, how can practitioners

incorporate this into their company employer brand image and consequent recruitment campaigns and tools for practical utility?

Here again it is worth noting that a deeper understanding of the nomological net of person latent variables and situational latent variables that determine performance is required as a first step in informing and guiding HR's efforts to attract talent in terms of employable Generation Y graduates. For example, an understanding of the working conditions under which Generation Y graduates perform optimally can be used as a frame of reference for a benchmark exercise to gauge to what extent an organisation is currently able to fulfil these conditions. Remedial actions can then be taken based on the results of this exercise, and revised working conditions that are in line with generation Y's needs can be established and then authentically included as part of the employer brand that is communicated to prospective employees. Hence, a deeper understanding of the nomological net of situational and person latent variables impacting on graduate job performance will go a long way in assisting HR departments to position their organisations as employers of choice among the new generation of employees and ensure that long-term staffing needs are met.

### **1.4.3 THE SELECTION OF GRADUATES**

A third challenge that HR departments face with regards to the dispositions and attainments domain of graduate performance concerns the selection of graduates. The attraction of a group of suitable applicants is a necessary prerequisite, but once this group has applied and has shown interest in a position, it is the HR department's responsibility to apply scientific methodologies that are legally defensible in differentiating between those individuals that are likely to be successful in the job, and those that are less likely to be successful in the job. This is especially important in the South African context, because labour legislation has been passed that prohibits unfair discrimination on any basis other than that of the inherent requirements of a job (Employment Equity Act of South Africa, 1998). In addition to being legally defensible, one would also postulate that the performance potential of graduates varies, and that the accurate selection of high potentials and deselection of unsuitable candidates will provide benefits to the organisation itself in terms of greater levels of performance.

In graduate selection decisions, future graduate performance is the criterion on which applicants should be evaluated to determine their assignment to either an accept or reject treatment (Cronbach & Gleser, 1965). Information on actual graduate performance is, however, not available at the time of the selection decision. The only alternative to random decision-making (other than not to take any decision at all), is to predict expected criterion performance (clinically or mechanically) from information available at the time of the selection decision and to base the selection decision on these predictions of graduate performance. In selection, the primary focus is on the criterion rather than on the predictor from which inferences about the criterion are made (Theron, 2007). This position is formally acknowledged by the manner in which the APA (American Psychological Association) interprets predictive validity as well as the generally accepted regression-based and selection fairness interpretations of selection fairness (Cleary, 1968; Einhorn & Bass, 1971; Theron, 2007). Future graduate performance can be predicted at the time of the selection decision to the extent that variance in the criterion can be explained in terms of a weighted combination of predictors (Theron, 2007). Binning and Barrett (1989) distinguish between two approaches to selection that differ in terms of the nature of the predictors and the underlying logic as to why the predictors are expected to explain variance in the criterion. In the construct-orientated approach to selection, measures of the person characteristics that determine criterion performance is obtained during selection. In the content-orientated approach to selection, criterion measures are obtained during selection by measuring performance off-the-job in either a simulation of the job or in a job resembling the target job. The construct-orientated approach is informed by the complex nomological net of latent variables underpinning performance (specifically the person-centred latent variables) and the content-



orientated approach to selection by the identity of the latent behavioural competencies constituting performance.

In regard to the aforementioned approaches to selection, it appears that in the South African context most graduate recruiters employ a form of a 'mixed' selection approach. This is evident in findings from the SAGEA Employer Survey (2014) indicating that behavioural-based interviews and off-the-shelf standardised psychometric assessments<sup>8</sup> are by far the most frequent<sup>9</sup> selection methods employed in the industry today. That is to say that the use of behavioural-based interviews is an attempt at the content approach to selection (e.g. assessing a candidate's past behaviour in previous work-related circumstances) and the use of psychometric assessments is based on the construct approach to selection where a candidate's competency potential (e.g. intelligence, conscientiousness, etc.) is assessed in order to make predictions about future performance on the job. More importantly, it can be said that unfortunately both of these selection methods fall short in delivering valid and fair criterion inferences that are a necessary prerequisite for selection decisions in a number of ways. With regard to the latter, one shortfall that can be identified is that psychometric assessments only measure competency potential latent variables underlying competencies without taking into account situational characteristics that co-determine work success, and are therefore subject to criticism.

With regard to the former, logic dictates that the extent to which behavioural-based interviews will allow the derivation of valid criterion inferences is questionable because interview questions for different graduate vacancies are usually formulated on an ad hoc basis by choosing from a library or suite of preformulated questions those that the recruiter deems the most *appropriate*<sup>10</sup> for the task at hand (e.g. making inferences about which questions would best reflect the required job outcomes). However, "graduates are often selected for their perceived general potential, rather than for a specific role in the company" (Cabellero & Walker, 2010, p. 15) which will make it difficult, if not impossible for graduate recruiters to develop interview guides that can be used for the derivation of valid criterion inferences. This is because: 1) in essence, behavioural interviews attempt to assess past formal work behaviour, which is something that a graduate typically does not have; and 2) it is doubtful whether measures of historic work behaviour can be used to make predictions about a candidate's future *general* potential. It would be surprising, therefore, if behaviourally based interviews offer the most predictive validity in situations where graduates are not applying for specific job roles and do not have sufficient experience to be able to answer work-related questions (Cabellero & Walker, 2010).

With regards to selection strategies, it appears that graduate selection decisions in South Africa are mostly based on criterion inferences that are clinically, as opposed to actuarially derived from predictor information obtained via behaviourally based interviews and psychometric assessments. The derivation of valid criterion inferences given this context is also questionable, as this will require the graduate recruiter to combine information from interview scores, personality assessments, etc. in their own mind in order to arrive at a decision about the predicted future work performance of a graduate. In borrowing from the work of Meehl (1954) and his work on clinical versus mechanical judgement, it can be said that given this type of approach and given the format of predictor information provided, it is highly unlikely that the human mind can process, comprehend and integrate all of the relevant factors that impact job performance in such a way as to as to make consistent and optimal graduate selection decisions. The ideal should

---

<sup>8</sup> Psychometric assessments utilised include (a mixture of) the OPQ, the MBTI, SHL ability tests, the CPP, the CPA, etc.

<sup>9</sup> 71% of graduate recruiters reported the use of behavioural interviews and 57% indicated the use of psychometric assessments.

<sup>10</sup> Interview guides utilised for specific graduate positions are usually also not properly standardised. Interview guides are commonly used at one specific time period every year and are then shelved for the next graduate recruitment campaign – i.e. the data obtained from the guides are not typically integrated with previous data obtained in previous recruitment cycles. Also, line managers that attend interviews as the hiring managers usually have some questions of their own that fluctuate from candidate to candidate in real time, which further contaminates any standardisation efforts.

rather be to develop an actuarial prediction model through which criterion inferences are derived mechanically (Grove and Meehl, 1996). Research studies conducted over an extensive period of time comparing clinical versus mechanical combination of predictor data in selection have consistently concluded the superiority of mechanically derived criterion inferences (Grove & Meehl, 1996; Grove, Zald, Lebow, Snitz, & Nelson, 2000). It is furthermore troubling to report that it is doubtful if most organisations in South Africa actually validate their (clinical or mechanical) graduate selection strategies. This phenomenon can in some cases probably be attributed to time and monetary constraints, or in other cases to the absence of formal, well-validated criterion measures of graduate performance and in still other cases to too small samples to develop actuarial prediction models and to validate the criterion inferences that are (clinically or mechanically) derived from predictor data. The latter two problems can be overcome through: (1) the development and validation of a generic graduate performance questionnaire; (2) the development of a generic graduate competency model that describes graduate performance in terms of structurally interrelated latent behavioural competencies and latent outcomes and that describes the psychological mechanism that regulates the levels of the latent behavioural competencies and latent outcomes; (3) the development of a generic actuarial graduate prediction model; and (4) the validation of the mechanical criterion inferences derived from the model (Myburgh, 2013).

From the above discussion it should be clear that there are many challenges that remain with regards to the advancement of the state of graduate selection in South Africa. Given this context, the goal for the HR profession should be to advance a job-behaviour/content orientated interpretation of graduate selection, one that is based on an actuarial prediction model (through which criterion inferences can be derived in a mechanical manner) and that includes validated criterion measures of graduate performance. To succeed in this endeavour it is again important to highlight the need for the development of a comprehensive structural performance or competency model that describes the manner in which graduate characteristics and situational characteristics structurally combine to affect the levels of performance achieved on the structurally interrelated behavioural competencies and outcomes that constitute graduate performance. The model is to be validated via statistical-or mathematical analysis from actual criterion and predictor data sets and to the extent that the model succeeds in explaining the psychological mechanism that regulates the levels of the latent behavioural competencies and latent outcomes, should be used as input to the formation of a new graduate selection strategy in South Africa.

#### **1.4.4 THE DEVELOPMENT OF GRADUATES**

A fourth challenge faced by any HR department with regard to the elevation of knowledge, skills and abilities in an organisation relates to the development of graduates. That is to say that graduates enter the business with certain levels of knowledge, skills, abilities and other malleable competency potential that have been developed during their time spent at tertiary educational institutions, but HR departments can further enhance the performance of graduates through the development of malleable competency potential (and competencies) relevant to graduate performance by way of employer-initiated training and development interventions that take place during the course of their employment with the organisation. In this regard the changing landscape of employee development and the unique learning styles and preferences of Generation Y are necessitating HR departments to rethink their traditional learning and development approach, which was perhaps too slow-moving, rudimentary, and exclusively focused on the development of technical competence (Kozlowski & Salas, cited in Kozlowski, Kraiger, Salas, & Teachout, 1997).

The concept of "talent management" that has enjoyed increasing prominence in the HRM and HRD literature (Collings, Scullian, & Vaiman, 2011; Stahl, Björkman, Farndale, Morris, Paauwe, Stiles, Trevor, & Wright, 2007) advocates the development of "a limited pool of organisational members who possess unique management and leadership competencies" (Garavan, Corberry, & Rock,

2011, p. 7). In the talent management paradigm, the term “talent” is often framed as “a limited pool of organisational members who possess unique management and leadership competencies” (Garavan et al., 2011, p. 7) and the focus of talent development is therefore on the development of an exclusive and elite group of high-potentials, future stars, future leaders or high flyers. Many organisations have graduate programmes which are designed to ensure a supply of high calibre executives for the future (Doherty, Viney, & Adamson, 1997, p. 173) and “high flyers, fast trackers and high potentials are normally drawn from a high-quality graduate population, with the assumption that they will be developed rapidly to become the future cadre of senior managers” (Doherty et al., p.173). Maybe, more importantly, the focus of talent development programmes has shifted to the development of generic competencies that high-potential employees are expected to display in order to meet the demands of a unique and continuously changing work environment (Garazonik, Nethersell, & Spreier, 2006) and that is deemed as important for ‘future potential’ and career advancement (Garavan et al., 2011).

Some examples of these competencies<sup>11</sup> have been identified as problem-solving, analysis, communication, teamwork, knowledge management, creativity, intellectual rigour, persistence, integrity and tolerance (Garavan et al., 2011; Sandberg, 2000). The development of these generic competencies provides unique challenges, as, unlike technical competencies (Garavan et al., 2011), generic competencies are more holistic, and tend to overlap and interweave (Capaldo, Landoli, and Zollo, 2006). They are also “intrinsically related to the kind of person (i.e. linked to individual competency potential) that one is” (Garavan et al., 2011, p. 8) and poses different development challenges than training someone on how to operate a forklift, for example. In addition, talent development initiatives such as graduate development schemes are also premised on an “accelerated learning curve” (Garavan et al., 2011, p. 10) that involves highly motivated learners, and comprises of ongoing intensive training interventions through the extensive use of simulation tools, structured projects and experiences to drive learning (Garavan et al., 2011). This is a different approach than traditional learning and development programmes that perhaps were more one-dimensional and had more of a fragmented “class-room instruction” mentality.

In addition, today’s graduates (Gen Y) “have different learning styles and preferences which need to be taken into consideration in the design of development schemes” (Connor & Shaw, 2008, p. 361). For example, Jonas-Dwyer and Pospisil (2004) propose that technology, entertainment and excitement are central to Generation Y’s learning and communication preferences while Hallam and Partridge (2006) postulate that curriculums should include real-world activities and perspectives as well as be customisable and flexible in order to resonate with Generation Y. Shih and Allen (2007) assert that experiential learning pedagogy works well with Generation Y, with Connor and Shaw (2008) proposing that graduates desire development that can enhance their professional skills and also therefore their future marketability and employability. This demonstrates that Generation Y has a need for practical relevance in their training (Sheahan, 2005), that technology has shaped how Generation Y learns and processes information (Martin, 2005), that they require development that will enhance their CVs (Hira, 2007), and that hands-on interactive and practical assignments (Fairhurst & Shaw 2008) will be beneficial to their learning prospects.

This conceptual work has advanced our understanding of the learning preferences of Generation Y and also the type of competencies that are required in high-potential employees. However, a multitude of questions remain. How do we develop effective audio-visually rich, practical training programmes that are fun and entertaining? What are the latent graduate competencies and

---

<sup>11</sup> It must be noted that these authors have a different interpretation of the term “competencies”. In their opinion, competencies refer to amongst others, skills, attributes and values. This research interprets competencies as being sets of behaviours that are instrumental in the delivery of the desired outcomes or to enable a range of work demands to be met more effectively by some people than others, and competency potential as dispositions, attainments and psychological states that influence competence on competencies.

malleable latent competency potential variables that need to be developed in a graduate development programme in order to ensure a future cadre of capable leaders? What learning principles still hold water when we start working with accelerated learning curves and high-potential employees? How do we measure transfer of learning when the goal of learning is not to master a task but to master a generic competency such as integrity? If it is taken into account that most graduate employers in South Africa spend about R700 000 per year on the training of their appointed graduates (SAGRA, 2012), answers to the above questions are crucial in ensuring that there is a return on investment. In short, “if you are going to invest heavily in their (talent) development, you want to be reasonably confident that the investment will pay off” (Fernandez-Araoz et al., 2011, p. 79).

In the same manner that graduate performance (conceptualised in terms of a structurally inter-linked network of behavioural graduate competencies and graduate outcomes) is systematically determined by a structurally interrelated network of person – and situation characteristics, learning performance (conceptualised in terms of a structurally interlinked network of behavioural learning competencies and learning outcomes) is also systematically determined by a structurally interrelated network of person – and situation characteristics. Moreover, these two structural models are sequentially structurally linked. Many of the answers to the foregoing questions lie in this integrated structural model.

## **1.5 GRADUATES AND THE MOTIVATION AND EFFORT AND OPPORTUNITY TO CONTRIBUTE DOMAINS**

### **1.5.1 THE OPTIMISATION OF GRADUATE PSYCHOLOGICAL STATES**

Another crucial function of the HR department once they have attained and developed talented graduates in the organisation is to optimise their performance levels by enhancing their motivation to perform and to maintain their employment relationship with the organisation through the fostering of psychological states like psychological empowerment, employee engagement, job satisfaction and organisational commitment that have been shown to be structurally related to performance (Harter, Schmidt, & Hayes, 2002; Liden, Wayne, & Sparrowe, 2000; Lumley, Coetzee, Tladinyane, & Ferreira, 2011; Riketta, 2008; Saif, Nawaz, Jan, & Khan, 2012) and turnover intention (Allen & Meyer, 1990; Carsten & Spector, 1987; Casper, Harris, Taylor-Bianco, & Wayne, 2011; Ding & Lin, 2006; Haslam, 2004; Tett & Meyer, 1993; Kark, Shamir, & Chen, 2003). Even the most inherently talented individuals that are highly trained, but that are not given the proper opportunities or support to perform, or that lack the motivation, will struggle to make valuable contributions and could even possibly withdraw themselves from a job-role or the broader organisational community. This is where psychological states like job satisfaction play a crucial role in motivating employees to higher levels of performance and organisational involvement.

Emotions are an important part of being human – emotions influence human motivation to behave in certain ways (Burrows & Stanley, cited in Cooper, 2005) and influence an individual’s perceptions of personal psychological health (Slaski, & Cartwright, 2003). Because employees’ organisational lives are imbued with affect through social interaction, (e.g. colleagues, supervisors, top management) as well as perceived job characteristics (e.g. promotion opportunities, pay, development opportunities, climate, management styles, etc.) their on-the-job (and possibly off-the-job) behaviours as well as their general prevailing “psychological state” are shaped by these factors in an ongoing and pervasive way. In addition to what the individual graduate brings to the role (i.e. his or her competency potential such as level of self-efficacy for example), managers and HR departments also therefore have some degree of latitude to affect their employees’ psychological well-being by crafting the malleable (i.e. job design, reward systems, etc.) variables that ultimately entrench the relatively non-malleable (i.e. operational creeds, structure and processes, values, philosophies, etc.), (Schein, 1992); variables that the organisational context in its totality comprises of. The wellness of an employee’s psychological

state has in turn been proven to be important in a number of important job (and probably also personal) outcomes (Judge & Watanabe, 1993; Wright & Cropanano, 2000) such as in-role job performance, extra-role performance (Chan, Taylor, & Markham, 2008) number of days' sick leave taken, (Spector, 1994) turnover intention, (Aryee & Chen, 2006) and absenteeism (Halfhill, Huff, Johnson, Ballentine, & Beyerline, cited in Lowman, 2002). Conversely, it follows that organisations should try and leverage employee well-being to achieve more positive work outcomes through their control over organisational characteristics such as job design, span of control and reward structures.

However, a great deal of research devoted to the investigation of the antecedents of psychological states such as job satisfaction, for example, has identified factors over and above organisational characteristics that can also effect employee well-being and the nature of their psychological states, namely that of individual-dispositional variables such as self-efficacy (Bandura, 1997; Judge, Thoresen, Bono, & Patton, 2001). Construed as a conviction that work activities can be carried out skilfully and successfully (Bandura, 1977), self-efficacy can be described as a competency potential variable (e.g. a rather inflexible, non-malleable disposition) that positively moderates the effects of negative demands (e.g. poor pay or no opportunities for development) impacting on the individual at work. In other words, it seems that if a person has a dispositional tendency to experience "being in control" of work activities (self-efficacy), they are more likely to experience a positive psychological state resulting from the appraisal of their job or job experience. Likewise, the opposite might also be true for employees with a negative experience dispositional tendency. Moreover, it appears that an employee's psychological state can shift (substantially or in increments) between two ends of a continuum from one performance cycle to another, depending on the success with which they performed certain work tasks. (Schaufeli & Harris, cited in Bauer & Hämmig, 2014).

One important psychological state that has enjoyed research prominence in recent years is employee engagement. Khan (1992, 1990) is frequently credited as the first researcher to apply the concept of engagement to the work setting and defined employee engagement as the "harnessing of organisation members' selves to their work roles" (Khan, 1990, p. 694). Khan's (1990) initial conceptualisation of engagement proposed that employee engagement is a "psychological act", or a temporary condition that drives employees to higher levels of performance (p. 694), but the literature on employee engagement has since evolved and engagement is now also being conceptualised as "a persistent positive affective state ... characterised by high levels of activation and pleasure" (Maslach, Schaufeli, & Leiter, 2001, p. 417). It has also recently been proposed that the act<sup>12</sup> of engagement could most probably lead to a psychological state of engagement (thereby integrating older and newer models of engagement), which could shed more light on the fundamental process underlying the origins of employee engagement (Joubert, 2016). Theoretical disparities notwithstanding, Schaufeli, Salanova, Gonzalez-Roma and Bakker (2002) propose that when an employee is engaged, he or she is characterised by vigour, dedication, and absorption. An employee demonstrating *vigour* is characterised by high levels of energy and mental resilience, the willingness to invest effort in his or her job, and persistence even in the face of difficulties (Bakker, Schaufeli, Leiter, & Taris, 2008).

*Dedication* refers to an employee being strongly involved in his or her work, and experiencing a sense of significance, enthusiasm, inspiration, pride and challenge (Bakker et al., 2008), while *absorption* is characterised by an employee being fully concentrated and happily engrossed in his or her work, even to the point where he or she will have difficulties with detaching him or herself from the work (Bakker et al., 2008). The advantages of having newly appointed graduates demonstrating high levels of energy, mental resilience, persistence and a willingness to invest

---

<sup>12</sup> More specifically it has been argued that this refers to an individual's decision to become immersed in a job role and organisation.

extra effort that is rooted in a sense of significance, pride and inspiration (e.g. being engaged) should be self-evident at this point.

Psychological empowerment is another popular psychological state that has enjoyed much research attention recently and has been defined as an active orientation in which an employee wishes to and feels able to shape his or her work role as well as work-context (Spreitzer, 1995). Spreitzer's (1995) validated measure of psychological empowerment that comprises of the cognitions of *meaning*, *competence*, *self-determination*, and *impact* could be used to facilitate better understanding of the phenomenon of psychological empowerment. *Meaning* represents the extent to which an employee judges the value of their work objectives in terms of their beliefs and standards. The *competence* factor refers to an employee's belief in their own ability to successfully conclude work activities<sup>13</sup> and the *self-determination* factor concerns the employee's sense of autonomy or control over work behaviour and processes. Finally, the *impact* factor reflects the employee's perceived influence level of their own behaviour on various organisational outcomes. Taken in its totality, it is Spreitzer's (1995) belief that an employee who places a high value on their work objectives, believes they have the ability to successfully conclude work activities and impact valued organisational outcomes, and has a sense of control over how they conduct work will therefore be more psychologically empowered, which in turn, should lead to positive organisational outcomes such as performance and lower turnover.

There are many other psychological states described in the organisational behaviour literature that are posited to influence job performance such as job satisfaction and organisational commitment to name just a few, but common to all of these are: 1) that the positive version of each is a desirable, positively valenced psychological condition in employees; 2) that they have a purpose in terms of desirable organisational outcomes; and 3) that they connote (a mixture of) involvement, commitment, passion, enthusiasm, effort and energy on the side of the employee. Thus, insights into these psychological states and the levers of the psychological mechanism(s) that regulate these states is crucial in achieving higher levels of performance amongst Generation Y employees. With the events that have defined their lives such as globalisation, rapid technological advancement and increasing demographic diversity Generation Y, however, is said to bring some different expectations (than all other previous generations) to the labour market (Ng et al., 2010). In other words, it is suggested here that the types of interaction that members of this generation require, the way they engage, the work characteristics that they value, and the approach to work and its role in their lives differ considerably from that of previous generations. For example, with regard to the tasks and roles that they perform (e.g. the dedication dimension of Bakker et al. (2008) and Spreitzer's (1995) meaning dimension), Generation Y individuals need to be given multiple, or parallel assignments (Eisner, 2005) that are intellectually challenging (Eisner, 2005) and allow them creative expression (Martin, 2005). With regard to the roles that they fulfil, they appear to want to be fast-tracked and enter the workplace at a higher level of authority (Maxwell, Ogder, & Broadbridge, 2007). They are also seeking roles where they can make a contribution to society (Allen, 2004) and make a real difference in the world (Eisner, 2005).

With regards to authentic interpersonal interactions at work, it is suggested that Generation Y individuals will value a work environment that is based on teamwork, (Eisner, 2005; Martin, 2005) diversity, equality, tolerance (Morton, 2002) and fairness (Eisner, 2005). It is also suggested that Generation Y individuals have less respect for rank in the workplace (Eisner, 2005), they value open and positive bosses (Morton, 2002), and want freedom to perform without being micromanaged (Eisner, 2005; Martin, 2005) in a fun and social environment (Lyons, 2003). Finally, with regards to Spreitzer's (1995) self-determination dimension, graduates need to be

---

<sup>13</sup> Graduates' standing on the *competence* dimension of *psychological empowerment* can be hypothesised to be dependent on *professional self-efficacy* which in turn is rooted in a subjective, personal appraisal of the extent to which they have developed an extensive meaningful knowledge structure during their academic training as well a subjective, personal appraisal of their graduate performance levels.

given a balanced lifestyle (Allen, 2004; Morton, 2002; Kerslake, 2005,) job flexibility (Foreman, 2006) and flexible working hours (Zupan, Kaše, Rašković, Wang, & Yao, 2015). Further possible contributions to this discussion on getting graduates more engrossed and in accord with their work roles and organisations include the recommendations that Generation Y individuals need to be given clear direction (Crumpacker & Crumpacker, 2007), managerial support (Martin, 2005), acknowledgement (Eisner, 2005), good pay and benefits (Ng et al., 2010), and immediate feedback (Francis-Smith, 2004).

In summary then, the implications of the above are that given the mass entry of Generation Y into the labour market, employers will have to respond to the Millennials' workplace needs if they are to maximise their chances of engaging and eliciting top performance from this resource. However, this requires a deep understanding of Generation Y graduates' motivational needs at work, how the organisational and job characteristics can be shaped to this end, and also what types of competency potential is required in graduate recruits to promote more desirable psychological states from this resource. Moreover, the importance of fully grasping the nomological net underpinning the work performance of graduates is underlined in that the explanation for the existence of a (type and strength) psychological state is located not in any individual net variable, but rather in a unique, "divine" set of variables spread across the net that impact each other richly and simultaneously. It is only by uncovering the working of this mechanism that HR practitioners can launch impactful interventions aimed at the psychological arousal/motivation of graduates in the organisation.

### **1.5.2 THE RETENTION OF GRADUATES**

Another crucial element of a high-performing HR system is the ability to retain the services of talented graduates. All previous efforts aimed at elevating the performance levels of the organisation will be in vain if the HR department cannot provide the type of growth opportunities, benefits and working life in which graduates want to express themselves, become involved and engaged in, and consequently commit to in terms of longer-term tenure.

This is of special significance as there has recently been a shift in graduates' perception of the psychological contract (McCracken, Heaton, & Harrison, 2008) and HR departments need to adapt accordingly to how this phenomenon will influence current and future attrition rates. In this regard, Kelley-Patterson and George (2002) highlight the contrast between the essentially transactional, medium- and short-term orientation of the modern graduate employee and how this differs from the longer-term expectations of managers and other employees, which is more typical of previous generations. This notion is consistent with what Beddingfield (2005) has described as the "evolution of a new kind of work pattern", with many graduates subscribing to a culture of "phased employment," moving from one organisation to another to gain vital experience, or to "binge" work for one or two years at a time (p. 201). This argument is also supported by King (2003), who believes that for graduates, employability is a key concern and that insights into how they expect their sets of marketable skills to develop may be an important key in understanding graduate turnover.

It has been postulated that graduates regard three years as a rigid guideline of an acceptable length of time to stay with an organisation to avoid being labelled as a "quitter" (McCracken et al., 2008, p. 278). This seems to be true in the United Kingdom, where research has indicated that 86% of graduate recruits leave organisations before the end of their third year (Beddingfield, 2005) and also in South Africa, where almost a third of graduate recruiters reported that they had lost more than half of their graduate starters who began with them in 2009 (SAGRA, 2012). If it is taken into account that "most organisations can expect to break even on their investment after the individual (e.g. the graduate) has spent a year in a senior or strategic role" (Beddingfield, 2005, p. 199), that it takes on average about five years for a graduate to move into a senior or strategic role (Beddingfield, 2005), and that only 7% of South African organisations surveyed in 2012 (SAGRA, 2012) retained all of their 2009 graduate intake, the costs associated with and the

extent of “graduate churn” should be worrying. In more specific terms, it has been argued that the direct costs associated with losing an employee ranges anywhere from one to three times the employee’s salary and this is without calculating the hidden costs of turnover such as lost productivity and reduced morale (Garger, 1999, p. 10). This rough estimation of the costs associated with turnover will also likely rise if the employee that leaves the organisation is a high-performing employee (Garger, 1999, p. 10). Given these statistics and findings, it is clear that graduate retention is indeed an aspect that should be addressed by HR departments. In other words, instead of believing that “graduate churn” is endemic as it perhaps to an extent is in industries such as retail or sales, and despite the fact that a certain amount of turnover could even be healthy, losing high performers is always costly (Garger, 1999).

The “best way to manage turnover and retain high performers is to implement a well-planned and coordinated retention strategy, which sometimes requires fundamental changes in how a company selects, develops, and rewards its employees” (Garger, 1999, p. 10). It has also been noted that “employee retention and engagement are joined at the hip” (Frank, 2004, p. 11) and it follows that a coherent HR system, that understands the unique needs of Generation Y and incorporates this into how graduates are attracted, selected, developed, and engaged should go a long way towards achieving higher levels of graduate retention in itself. A good starting point on which to base an effective retention strategy, however, is to conduct exit interviews and internal surveys in order to establish the exact reasons for attrition (McCracken, et al., 2008). However, as this information is often kept confidential by organisations, it might be beneficial for the purposes of this discussion to consider the responses of 1689 participants in a recent survey on graduate recruits in South Africa on this matter (SAGRA survey, 2012) instead. The results of this survey indicate that 75% of the respondents regard the remuneration package offered by the organisation as a major factor in their intention to stay longer with their current employer. According to the survey, 67% of graduates also indicated that promotion and career advancement opportunities in the organisation will influence their intention to stay longer, 60% indicated that the ability to move within the organisation would influence their intention to stay longer, and 60% indicated that work-life balance will influence their intention to stay longer with their employer (SAGRA survey, 2012).

The notion that South African graduates regard a good remuneration package as a driver of their intention to stay is also mirrored elsewhere, as in a recent study in the United Kingdom, pay was found to be the single most important motivational factor for Generation Y individuals (Corporate Leadership Council, 2014). Some generation Y individuals are even reported to wonder why they are not getting pay raises after only six months on the job (Erikson, Alsop, Nicholson, & Miller, 2009). These individuals’ “emphasis on financial reward may reflect in part, the Millennials’ need for feedback” (Ng et al., 2010, p. 282) or their need for approval and praise (Crumpacker & Crumpacker, 2007). The expectation of good pay and benefits may also reflect the sense of entitlement that exists amongst Generation Y individuals (Ng et al., 2010, p. 282). If one then takes into account that the median remuneration package for a graduate recruit in South-Africa was R155 000 in 2014, this places greater pressure on companies with graduate programmes that want to retain the top candidates to be able to match the competitive salaries offered by some graduate recruiters, some of which in certain industries already offered packages in excess of R380 000 to graduate recruits in 2014 (SAGEA, 2014). However, even though in some companies “the issue of salary levels could be even more pertinent” (McCracken, et al., 2008, p. 282), “it may not be wise to focus primarily on money when designing a retention strategy” (Garger, 1999, p. 15) as development opportunities can be seen by some graduates as a trade-off for pay” (McCracken, et al., 2008, p. 282).

With regard to opportunities for development, it was also noted that South African graduates regard career advancement opportunities and the ability to move within the organisation as important drivers in their intention to stay. In essence, this view comes down to an underlying need for development, and the “connection between development and retention is stronger than



ever” (Garger, 1999, p. 13). That is to say that graduates are “aware of the faster pace of change in the business world”, that “they want to improve their employability” and want to feel “confident that they will be well-prepared for wherever they go” (Garger, 1999, p. 13). However, many organisations feel that it is a waste to invest money into making their employees more employable, as this will make them more marketable and therefore prone to be poached by competing organisations. This approach by organisations might seem logical, but ironically, when companies provide opportunities for their employees to become more marketable by acquiring new skills, job satisfaction increases and those employees are more likely to stay on in the organisation (Garger, 1999).

A third apparent driver of South African graduates’ intention to stay longer with an employer is work-life balance. This fixation on work-life balance might have come about because young graduates have observed their Generation X parents work long hours and make many work-related sacrifices, only to fall victim to corporate downsizing, high divorce rates (Loughlin & Barling, 2001), and stress-related illnesses. They are possibly therefore wary of being caught in the same position, and are inclined to choose making a life over making a living (Loughlin & Barling, 2001).

In addition, other research studies have highlighted the key roles that line managers play in the retention of staff (McCracken, et al., 2008). This is because “managers and supervisors can help employees feel empowered by providing them the necessary means, ability and authority to achieve success” (Meyerson & Kline, 2007, p. 448) and therefore can contribute significantly to the retention of a talented workforce (Oehley, 2007). There are also numerous studies that signal that “employees don’t leave good companies, they leave bad bosses” (Peterson, 2005, p. 87). Given the fact that generation Y individuals need to be given clear direction (Crumpacker & Crumpacker, 2007), managerial support (Martin, 2005), acknowledgement (Eisner, 2005), and immediate feedback (Ng et al., 2010), it might further be a good idea to align line manager and supervisor responsibilities with the development and succession paths of new graduates. In fact, some organisations are using the entry of new graduates to provide management with the opportunity to develop their mentoring and coaching skills (McCracken, et al., 2008). “When managers are held responsible for these activities – and their performance is evaluated on this basis – it ensures that employees develop the right competencies and sends a strong message to high performers that the company wants them to stay and is committed to their success” (Garger, 1999, p. 14).

From the above it should be clear that, “in today’s dynamic business environment, companies that want to remain competitive must adapt a strategic approach to retention” (Garger, 1999, p. 10). In order to do so effectively, companies must not underestimate the expectations of (Gen Y) graduates (Zhao, 2006) and incorporate aspects such as pay expectations, work-life balance, development needs and the empowerment of supervisors and line managers into their retention strategies. In the end, a beneficial way to interpret the reason for a graduate’s decision to leave an organisation or his or her *turnover intention* is to once again look at the problem from the perspective of a graduate nomological net of person-centred latent variables, situational latent variables, latent behavioural competencies and latent outcome variables. That is to say that a graduate’s turnover intention will be embedded in this nomological network and an understanding of the levers that regulate turnover intention can be found within this abstract framework. Given Generation Y’s propensity to vigorously manage their own careers, a failure to conceptually grasp this framework might mean that an organisation’s future talent might self-manage themselves out of the organisation entirely (Beddingfield, 2005). At the same time, however, a dedicated explanatory graduate ‘intention to quit’ structural model will probably have to eventually be developed to obtain a more detailed, penetrating description of the manner in which internal and external forces combine in the psychological mechanism that regulates the turnover intention of graduates.

## 1.6 RELEVANCE AND SIGNIFICANCE OF THE STUDY

“The above discussion develops an image of graduates who are increasingly becoming sophisticated in terms of their expectations from potential employers” (McCracken, et al., 2008, p. 279). In reaction to these expectations, the aforementioned discussion also highlights the different domains in which the HR department can potentially add value. Given the mass entry of Generation Y into the labour market, the value that HR departments could add in eliciting top performance from graduates, and therefore the role that they can play in growing the future economic performance of the country should not be underestimated. Numerous potential value-adding research obligations were stated with regards to increasing the employability of graduates, as well as the attraction, selection, development, engagement, and retention of graduates.

Moreover, it must be noted that the impending “5/50 crisis”<sup>14</sup> (Lacey & Groves, 2014, p. 400) that will lead to the retirement of almost a third of all Americans (76 million) alone over the next ten years, many which represent the (top) leadership cadre of the baby boomer generation, will place an additional responsibility on HR departments to “create a bench of strength from which to draw future leaders” (Lacey & Groves, 2014, p. 401). Central to future business success or failure will be the people who lead our companies; those who remain on in senior roles but also those who are being primed for future leadership positions. The reasoning behind this argument is simple – effective leaders can mean the difference between outstanding and poor organisational performance. Effective leaders steer organisations to success, inspire and motivate followers, they spearhead change, drive innovation and provide a moral compass for employees from which to set direction. Poor leaders, on the other hand, can inflict a considerable amount of damage on organisations, demoralise staff and destroy value. One does not need to search far to find examples of how poor (and unethical) leadership in South African society have left destruction in its wake from the gross expenditure scandal of president Jacob Zuma’s’ homestead, the fall of the National Police Commission Jackie Selebi that is linked to unlawful dealings with the drug lord Glen Agliotti, to the allegations of state capture by the Gupta family, and most recently the Steinhoff saga. South African leaders also have to address a number of further challenges that is unique to this country. These include poor labour market efficiency undergirded by rigid hiring and termination of employment, the inflexibility of organisations in determining compensation, significant tensions in employee-employer relationships (Eustace & Martins, 2014) and a general lack of urgency to move away from more conventional transactional leadership employee-employer relationships (Maritz, 2000). Businesses in the country have perhaps also not fine-tuned their capability to keep track of their (global) competitors and have not sufficiently seized upon export-led industrial growth opportunities, which is perhaps a legacy of the country’s Apartheid sanctions. All of these challenges require strong leadership and high-quality relations between leaders and employees so that they can work together to find the appropriate solutions (Eustace & Martins, 2014). “It is essential to improve leadership... (it is) necessary for improved productivity, market share growth and profitability. This is important, given South Africa’s unique position of being an emerging market economy with a diverse workforce, affirmative action policies and an open economy that gives its workforce little protection (Eustace & Martins, 2014, p. 1-2).

While the “need for leadership development has (thus) never been more urgent” (Narayana’s & Moldovan 2019b, p. 42) in this country, today’s volatile, uncertain, complex and ambiguous business environment also necessitates leadership skills and organisational capabilities in organisations that are different from those of the previous generation’s leaders that helped them succeed in the past (Narayana’s & Moldovan, 2019b). Nevertheless, leadership development ironically remains one of the least explored topics in the field of leadership research (Harrison, 2017; Martinelli & Reznikov; Subramony, Siegers, Chadwick, & Shay sunder, 2018) and many

---

<sup>14</sup> The expectation is that industry will lose up to 50% of all of their management talent over the next five years.

questions remain. For example, is leadership effectiveness universal and do all organisational leaders around the world require the same fundamental competency set? If so, what are the actual identities of the competencies that will make organisational leaders effective in the future? What is the generic competency potential variables (i.e. Emotional intelligence, IQ, locus of control, etc.) that play a role in deterring leaders' potential to perform leadership competencies well? Is there a natural pattern or structure germane to organisational leadership development and maturation and if this exists, how can such knowledge be applied in facilitating a greater return on investment on leadership development programmes? Furthermore, it is now widely accepted that the leadership skills (or competency) transfer is costly and difficult to accomplish through "purely didactic methods such as lectures, quizzes, and exams" (Narayana's & Moldovan, 2019a, p. 48), but what are the alternatives and what organisational and situational variables (i.e. conditions, systems and processes) need to be in place to facilitate effective behavioural change in terms of leadership development in the future? What and where are the tools that could be fused with technological advances in order to measure, track and shape leadership development and effectiveness in a more meaningful and powerful way?

Whether the aim is to nurture leaders internally, or to recruit the most talented external candidates from outside, the crux of the matter is ultimately that in an increasingly competitive market that fights for talent, the search, retention and development of the leaders of tomorrow is a challenging, yet vital task. Answers to these afore-mentioned questions can be found only when the complex nomological network of latent variables characterising the graduate (i.e. transient psychological states, malleable attainments and rather inflexible, non-malleable dispositions) and characterising the work environment (i.e. job characteristics, job demands, span of control), that affect graduate leader performance and turnover, is firstly validly mapped and understood. McCracken, Currie, & Harrison (2016, p. 2731) also argue persuasively for the explication of the 'modern' graduate nomological network as follows:

Graduates are often seen as an enigma because their potential is offset by specific challenges such as poor work readiness and unrealistic expectations about the world of work. Recent graduates also fall into the Generation Y category which has different characteristics from other workforce generations... This means those tasked with designing and implementing the right Talent Management strategy for graduates need to understand the specific nature of the graduate talent pool.

However, the development of such a comprehensive (5 domain – see Figure 2.3) graduate competency model is a massive and ambitious undertaking that needs to be approached in phases. A highly ambitious objective in itself would have been to target the development of the full graduate (leader) performance construct (as part of an overarching competency model) as discussed earlier that comprise of structurally interrelated behavioural competencies and outcome variables. However, this would have implied the development of two different structural models (competency domain and outcome domains), a further hypothesis on how the variables in these two different domains structurally relate to each other, and the development of two reliable, construct valid and unbiased measurements measuring the behavioural competencies and the outcomes of graduate (leaders) at work respectively. Consequently and in order to concentrate the study on a comprehensive explication of one of these domains as the starting point for a future, larger set of studies, a decision was made for the present study to focus on the 1) derivation of a structural model depicting the *competency domain (behaviour)* of graduate leader performance, 2) development of an instrument (the PGLCQ) that can be used to measure graduate leaders' standing on these graduate leader competencies, and 3) examining the psychometric properties of the PGLCQ.

## 1.7 RESEARCH-INITIATING QUESTIONS

Amidst the impending retirement of the world's most senior managers, there is a burning need to create a bench of strength from which to draw future leaders. The world of work continues to change and the complexities associated with the management of a successful business is well documented in an imposing and ever-growing body of literature. However, the research on leadership development has unfortunately not kept track with these developments and the vital questions as to what high-performance leadership in an organisational context means and how to develop organisational leaders that can effectively steer modern organisations into the future is unfortunately still not that well understood. While a complete understanding of what leadership (and its development) entails is only possible with the complete explication of the nomological network that explains the psychological mechanism regulating graduate (leader) performance, an understanding of the competency (or behavioural) domain of graduate (leader) performance will nonetheless provide (incremental) insights and serve as the first step of a larger, comprehensive series of studies.

The research initiating questions are consequently the following three open-ended questions:

- a) What is the connotative meaning of the graduate (leader) performance construct interpreted behaviourally?
- b) What is the denotative meaning of the graduate (leader) performance construct interpreted behaviourally? and
- c) Does the Pienaar Graduate Leader Competency Questionnaire<sup>15</sup> (PGLCQ) utilising these denotations as stimuli provide a reliable and construct valid measure of the to-be-measured construct as constitutively defined?

At this point it is important to distinguish between the use of the terms 'connotative' and 'denotative' and what these specifically refer to within the context of the current study. The *denotative meaning* of the graduate (leader) performance construct (behaviourally interpreted) refers to the observable behaviours in which the construct manifests itself. The behavioural denotations of the graduate (leader) performance construct are important because they will be used as the basis of the items of the PGLCQ (Kerlinger & Lee, 2000). The denotative meaning of the graduate (leader) performance construct is explicated through the operationalisation of the construct in a measured operational definition. The denotative meaning is dependent on the connotative meaning of the graduate (leader) performance construct. The *connotative meaning* of the graduate (leader) performance construct (behaviourally interpreted), on the other hand, refers to that which one has in mind when one uses the word *graduate (leader) performance construct* (as a sign) that represents an abstract idea. The connotative meaning of the graduate (leader) performance construct refers to all of the latent variables that are central to its conceptualisation in a research setting or framework. The connotative meaning of the competency domain of the graduate (leader) performance construct more specifically refers to the internal structure of the construct as well as the manner in which the construct is embedded in a larger nomological network of latent variables. The connotative meaning of the graduate (leader) performance construct is explicated through the conceptualisation of the construct.

To measure the graduate leader performance construct (interpreted behaviourally) via the PGLCQ, specific behavioural denotations of the construct as constitutively defined needed to be generated. That in turn then brought the overarching substantive research question to the fore as to whether the PGLCQ provides a construct valid measure of the graduate leader performance construct (interpreted behaviourally) as constitutively defined. The question is whether

---

<sup>15</sup> The PGLCQ measuring the level of competence that graduates achieve on the graduate competencies that constitute success will form the first subscale of an eventual two-scale Graduate leader performance Battery (GLPB) namely the first part. The second subscale of the GLPB will be the Graduate Leader Outcome Questionnaire (GLOQ) that will measure the graduate (leader) outcomes achieved at work. This scale will be developed in a future study.

inferences on the graduate leader performance construct may permissibly be derived from the dimension scores of the PGLCQ. This will firstly entail testing the measurement model implied by the connotative meaning of the graduate leadership performance construct taken in conjunction with the design intention of the PGLCQ (i.e. the manner in which items representing behavioural denotations of the performance construct have been assigned to reflect graduates' standing on specific latent second-order competencies). This will secondly entail testing the structural model implied by the connotative meaning of the graduate leadership performance construct as expressed by the internal structure assigned to the construct taken in conjunction with the design intention of the PGLCQ. Evaluating the construct validity of the PGLCQ by testing the fit of the structural model that describes the internal structure assigned to the graduate leader performance construct therefore also represents testing a substantive research hypothesis in the form of a (partial) competency model that claimed to describe the behavioural component of the psychological mechanism that regulates *graduate leader performance* in South African organisations. Schmitt and Landy (cited in Schmitt & Borman, 1993, p. 286) clearly affirm the foregoing position by stating:

Marshalling evidence of validity is now seen as a process of theory development and testing (Binning & Barrett, 1989; Landy, 1986). We must develop and articulate theories of job performance and define logically the constructs that are central to these theories. We must establish a 'nomological network' that relates constructs important in the job performance domain to the constructs we choose to identify qualified job applicants. This requires evidence that the measures we use to operationalize constructs in the predictor and performance domains possess a logical relationship to these constructs and empirically consistent relationships to other measures of the construct. The research initiating questions are purposefully formulated as open-ended questions to allow the theorising in response to the research initiating questions in the literature study to shape the research problems and research hypotheses. It is only when a research study honestly, without restraint, intellectually grapples with the research initiating question over a prolonged period of time that research truly stands a chance of gaining a valid understanding of the connotative and denotative meaning of the construct of graduate (leader) performance. Latent behavioural competency variables have to earn their inclusion in the performance structural model that is offered as an answer to the first research initiating question by being indispensable in the construction of a logically persuasive conceptualisation of graduate (leader) performance. Behavioural denotations of graduates' standing on the latent behavioural leadership competencies have likewise to earn their inclusion in the PGLCQ.

## 1.8 OBJECTIVES OF THE STUDY

The objectives of the study consequently are:

- a) To explicate the connotative and denotative meaning of the competency domain of the generic graduate leader performance construct (behaviourally interpreted);
- b) To develop the Pienaar Graduate Leader Competency Questionnaire (PGLCQ) that can be used to obtain multi-rater assessments of the competency domain of the graduate leader performance construct;
- c) To evaluate the reliability and construct validity of the PGLCQ by evaluating the fit of the measurement model implied by the architecture of the questionnaire, the constitutive definition of the graduate leader performance construct (behaviourally interpreted) and the multi-rater nature of the PGLCQ; and
- d) To evaluate the construct validity of the performance measure by evaluating the fit of the structural model reflecting the internal structure attributed in terms of the

conceptualisation of the construct to the graduate leader performance construct (behaviourally interpreted).<sup>16</sup>

## 1.9 CONCLUSION

The introductory chapter argued for the explication of the graduate (leader) performance construct (behaviourally interpreted). The importance of this overarching research aim was highlighted within the context of South Africa's sub-par performance on the world stage in terms of productivity and economic growth, and the potential value that HRM can add in effectively and efficiently managing the country's most valuable resource, namely the new generation of employees, as one solution to the productivity problem. More specifically, it was said that the graduate pool of the new generation of employees represent the main source of leadership bench strength, and because these individuals' post-graduate lives will affect the wider society, political order, and more importantly the economy, as they start taking on influential leadership roles in these domains, that no effort must be spared in the quest to identify, develop and retain this talent. The chapter that follows will review job performance theory, explain the current study's interpretation of competencies and competency modelling, and provide a comprehensive literature study on leadership and managerial requirements for the 21<sup>st</sup> century. Chapter 2 will also define a competency set (as well as the structural relations that are hypothesised to exist between them), which is offered as a partial description of the psychological mechanism that regulates differences in job performance across (strategic) graduate leaders.

---

<sup>16</sup> Once the second part of the GLPB (i.e the questionnaire measuring graduate leader outcome performance) is developed in a subsequent study it will be possible to evaluate the construct validity of the GLPB more stringently by fitting the structural model implied by the constitutive definition of the entire graduate leader performance construct.

## **CHAPTER 2: LITERATURE STUDY**

### **2.1 INTRODUCTION**

The chapter that follows in its entirety constitutes the theoretical literature review that was utilised to explicate the connotative meaning of the graduate leader performance construct by developing a structural model of graduate leader performance (behaviourally interpreted) that captured the internal structure that was attributed to the construct. The chapter firstly contextualises competencies in relation to job performance theory and describes how a competency model framework can be used to map a nomological network of variables, within qualitative diverse yet related domains, as a comprehensive job performance hypothesis. Secondly, the chapter touches on several graduate (leadership) roles and clarifies which one of these the current study is aiming to explicate. This is followed by a discussion on several philosophical debates on leadership that impacts the focus of the unfolding literature study such as the differences (or similarities) between leadership and management, and the differences between collective and individual leadership. The remainder of the chapter is devoted to the explication of the graduate (leader) performance construct. Systems theory was utilised as the scientific skeleton from which to dredge leadership and systems theory, a discussion which culminates in the identification of nine (second-order) competencies as well as a hypothesis on the structural relations hypothesised to exist between them that are offered as a description of psychological mechanism that regulates (and explains) differences in job performance across (strategic) graduate leaders.

### **2.2 THE COMPETENCY APPROACH TO JOB PERFORMANCE MODELLING**

With the previous chapter highlighting the need for the development of a graduate (leader) competency model, it is necessary to review the literature on competencies and competency modelling in order to lay the necessary foundation for the development of such a model. Hence, the first part of the literature review that follows will investigate the origin of competencies and also how the competency approach is typically implemented. The section will close by outlining what is regarded as best practice in the area, an approach that will also be adopted and endorsed in this study.

Although the term “competency” has been used extensively in the fields of Law, Clinical Psychology, Vocational Counselling and Education (Shippman, Ash, Battista, Carr, Eude, Hesketh, Kehoe, Pearlman, Prien, & Sanchez, 2000), the “introduction of competency-based approaches within the corporate environment initiated around 1970” (Draganidis & Mentzas, 2006, p. 52) and “the distinguished Harvard psychologist, David McClelland is credited with introducing the idea of “competencies” into the Human Resources literature” (Draganidis & Mentzas, 2006, p. 52). In essence, David McClelland (1973) emphasised the importance of criterion sampling to effectively capture the behaviours that differentiate good performance from poor performance, and then incorporating the criterion samples or “competencies into the (job performance hypothesis) testing process” (Stevens, 2012, p. 89). More specifically, McClelland (1973) suggested that personal competencies are a better means of predicting occupational success than traditional psychometric measures such as for example IQ and personality. He proposed that the advantage of using a competency approach as a framework for a job performance hypothesis lies in “creating a direct link between behavioural competencies and performance outcomes, rather than relying on inferences drawn from certain trait and intelligence factors” (McClelland, 1973, p. 8).

“There were several flaws<sup>17</sup> in his original paper” (Stevens, 2012, p. 4) such as a failure to explicitly define what a “competency”<sup>18</sup> is, but with the Human Resources field being saturated with studies exclusively focusing on the link between personality and/or intelligence and future occupational success, his work was enormously influential (Markus, Cooper-Thomas, Allpress, 2005) in opening up debate about more credible and valid theories for why the job performance of working man varies. Of particular interest was the idea that in addition to personality and IQ, there were other factors associated with individual success and that these could be identified and imparted (i.e. malleable competency potential and competencies) to others (Markus et al., 2005), thus adding more depth and complexity to the study of individual performance at work. Notwithstanding the divergence of definitions that have been brought forward for the term “competency” over the years as can be seen in Table 2.1 below, for explanatory purposes and sake of simplicity, it can be said that during a competency modelling exercise, competencies that are required<sup>19</sup> to be successful in a job role are identified and expressed in terms of a category (a group to which similar competencies belong), a name (a descriptive name for the specific competency), a definition (a statement or statements that explains the basic concept of a competency), and demonstrated behaviour (indicators which an individual should demonstrate if the specific competency is possessed) (Draganidis & Mentzas, 2006).

Table 2.1

*Influential competency definitions*

DEFINITION	AUTHOR
Competencies can be described as underlying characteristics of individuals, which are causally related to effective job performance.	Boyatzis (1982)
Competencies are “strategic” in nature as it relates to the businesses’ strategy and refers to the collective learning of an organisation.	Prahalad & Hamel (1990)
Competencies can be viewed as a cluster of related knowledge, attitudes, and skills that affect a major part of one’s job (i.e. one or more key responsibilities); that correlates with performance on the job; that can be measured against well-accepted standards; and can be improved by way of training and/or development interventions.	Parry (1998)
Competencies are sets of observable performance dimensions, including knowledge, skills, attitudes, and behaviours of individuals as well as collective team, process, and organisational capabilities, that are linked to high performance, and provide the organisation with some form of competitive advantage.	Athey & Orth (1999)
Competencies are sets of behaviours or repertoires of capabilities, that are instrumental in the delivery of the desired outcomes or to enable a range of work demands to be met more effectively by some people than others.	Bartram (2004)
Competencies refer to underlying work-related characteristics on an individual level (e.g. skills, knowledge, attitudes, beliefs, motives and traits) that enable success in a job as it relates to the strategy of an organisation.	Chen & Naquin (2006)
Competencies can be viewed as collections of knowledge, skills, abilities and other characteristics that are required for superior performance in the job in question.	Campion, Carr, Fink, Ruggerman, Phillips, & Odman (2011)
The varied knowledge, values, abilities, and behaviours that people need to possess and exercise to achieve the strategic objectives, goals, and performance expectations of the organization.	Croft & Seemiller (2017)

<sup>17</sup> For example, based on erroneous interpretations of other studies, McClelland claimed that intelligence and aptitude tests did not predict occupational success nor important life outcomes and that psychometric tests and academic performance only predicted job performance as a result of an underlying relationship to social status (Barrett & Depinet, 1991).

<sup>18</sup> McClelland used the term competency at times to refer to the output gained from the criterion sampling process (e.g. demonstrable behaviour) and at other times to refer to cognitive skills (e.g. reading, writing, calculating) and even personality traits (e.g. patience) (Stevens, 2012). This early conceptual confusion was unfortunately inherited by others throughout the course of the development of competency modelling (Shipmann et al., 2000) – see Table 2.1.

<sup>19</sup> The term “required” as used here in the phrase “... competencies that are *required* to be successful in a job role ...” can on the one hand be interpreted in a deterministic sense (competencies cause the job incumbent to be successful) or on the other hand in a constitutive sense (competencies comprise success).



These competencies are also then organised into a framework that is commonly referred to as a competency model (see Table 2.2 below). “Competencies are the building blocks of competency models” (Draganidis & Mentzas, 2006, p. 56) and competency models in their simplest form are often (narrowly) described as “a simple list or catalogue, specifying desirable competencies” (Markus et al., 2005, p. 117) “in a specific job, job family, organisation, function, or process” (Marrelli, Tondora, & Hoge, 2005, p. 537). The underlying goal is then for this “dictionary” of competencies or competency model to be used as the foundation for Human Resources departments to plan and guide interventions (e.g. selection, training and development, and performance management) aimed at improving the performance of the employees that they are responsible for.

Table 2.2

*An example of a (narrowly) operationalised competency model*

CATEGORY	COMPETENCY DEFINITION	DEMONSTRATED BEHAVIOUR
PEOPLE MANAGEMENT COMPETENCIES	<b>Building team spirit:</b> Providing team members with the excitement and desire to cooperate with each other, contributing to common goals.	<ul style="list-style-type: none"> <li>Encourages help and respect to other team members.</li> <li>Creates a common mission and feeling of belonging to a team, which aims at that.</li> </ul>
	<b>Developing people:</b> Help team members to reach their potential in personal development.	<ul style="list-style-type: none"> <li>Providing mentoring and experience transfer.</li> <li>Providing feedback on strengths and weaknesses of team.</li> </ul>

*Note.* Adapted from Competency based management: a review of systems and approaches, by Draganidis, F., & Mentzas, G., 2006, *Information Management and Computer Security*, 14(1), p. 54. Copyright 2006 by Emerald Group Publishing Ltd.

The graduate leader performance construct was conceptualised in Chapter 1 as a nomological network of structurally interrelated latent behavioural competencies that affect structurally interrelated latent outcome variables. It is highly doubtful that a simple list of behaviours (as provided above) that are assumed to all be equally significant in describing job performance provides a true reflection of the graduate leader job performance domain. Moreover, with reference to the complex nomological network comprising malleable and non-malleable variables characterising employees and malleable (and possibly non-malleable) variables characterising the organisational context that are richly interconnected, the researcher remains unconvinced that a simple list of behaviours (as provided above) that are assumed to all be equally significant in describing job performance provides a penetrating, valid insight into the nature of the psychological mechanism that regulates graduate leader performance. It is true that under content orientated logic (Binning & Barrett, 1989) the prediction of work performance is possible from off-the-job measures of competencies with minimal insight into the situational- and person characteristics that impact on the work performance of a graduate (leader). A very attractive feature of a competency-based selection procedure is that the same nomological network of person-centered and situational characteristics that determine the level of competence that is achieved on the competencies on-the-job also operate to affect performance in the off-the-job competency assessment, provided that the task and contextual demands, constraints and facilitators that apply to the job also apply to the assessment context.<sup>20</sup> A disadvantage of a competency-based selection procedure based on a content-orientated logic, on the other hand, is that it is practically rather difficult to assess the full spectrum of competencies that constitute performance. Moreover, even if it were feasible, selection in and by itself cannot ensure satisfactory performance. Additional interventions other than selection are also required. A

<sup>20</sup> Under content orientated logic, competency assessments would typically either be obtained in simulations ‘off-the-job’ but also sometimes, albeit rather seldom, in a natural job that resembles the target job.

competency model in this dictionary sense would not provide meaningful directives to these other applicable human resource interventions. It would therefore be false to argue that a competency model in the dictionary sense as it was defined above would be sufficient to ensure satisfactory graduate leader performance. It needs to be acknowledged that the world around us is complex in nature and that understanding, predicting, and indeed exercising control over the environment around us is only achievable with intense effort based on valid insight in the complex nomological network underpinning the events in World 1 (Babbie and Mouton, 2001) that we aspire to control.

The above can therefore be seen as a very elementary and narrow, informal approach on how competencies can be identified and organised into a competency model – one which is unfortunately often employed in organisations and endorsed by many human resource consultants today. That is to say that unfortunately, with the competency approach's rise to prominence (Bartram, 2001), the focus has been on getting competencies implemented, rather than on critically questioning the scientific basis of the implementation approaches (Markus et al., 2005; Shipmann et al., 2000). Also, as can be seen from the lack of consensus on how the term competencies has been defined over the years in Table 2.1, along with the explosion of the use of the competency approach came a proliferation of competency models (Bartram, 2001) developed for different organisations, (cultural<sup>21</sup>) contexts, and purposes by practitioners with differing views on and varying levels of proficiency in the methodology.

Unfortunately, as a consequence, there are different competency models in circulation today that utilise different organising frameworks, varying definitions of the term competency, and that are based on varying degrees of scientific precision – in short these models do not “talk to each other” and most of them lack the required scientific substance, which makes it difficult to hand-pick one specific approach or model that can be co-opted for use in this study. Of particular concern is the construct, content, criterion and predictive validity of some of the competency models that are in use in the world of work today (Markus et al., 2005) as well as the inability to and/or reticence in conducting proper validation studies. This should be greatly discouraging to researchers and practitioners in the field in South Africa specifically<sup>22</sup>, because “if a (competency) model will be used to make employment decisions, the process of identifying competencies must adhere to rigorous standards” as “the organisation's ability to successfully defend these decisions depends heavily on the reliability and validity of the competency model” (Marrelli et al., 2005, p. 538) utilised for these purposes.

Fortunately, and as Draganidis and Mentzas (2006) aptly suggest, the researcher can organise the methodology and terminology employed for the design of a competency model according to the need for its creation. This allows the researcher to propose a broader competency-based (and validation) approach of his own for the purpose of studying graduate performance as it is believed that there is room to further refine current practices (Stevens, 2012) and stimulate further thinking in this area. By doing so, the researcher in the current study will attempt to present a competency model that is more likely to reflect the true realities of the graduate work domain space than a simple dictionary list of behaviours could, and that in addition also reflects the complex nomological network of richly interconnected latent variables characterising graduates and the organisational context in which they operate. Such a model could be utilised to inform the full spectrum of Human Resource interventions aimed at improving graduate performance by ensuring that each respective intervention (i.e. stock and flow) “work in concert” (Jiang et al., 2012) with each other as an integrated whole, rather than as a number of independent, separate

---

<sup>21</sup> For example, in the United States competencies are more defined along the lines of **human traits** while in the United Kingdom competencies are more defined as **observable behaviours** (Le Deist & Winterton, 2005).

<sup>22</sup> The Employment Equity Act 55 of 1998 promotes equal opportunity and fair treatment in employment through the elimination of unfair discrimination, placing an onus on employers to be able to prove that employment decisions are based on inherent job requirements.

interventions. Such a developed model can also be tested across different organisations, which would open up the possibility of arriving at an actuarial prediction model that can be offered to Human Resource professionals in the industry to guide their graduate (leader) appointment decisions. In order to do so, one of the first decisions that needs to be made at the start of the theorising aimed at the development of a graduate leader competency model in the current study is how the term “competency” will be defined, as the way in which this is done will have a knock-on effect on the rest of the study. In following the intention of McClelland’s (1973) initial suggestion regarding the use of competencies (e.g. capturing the behaviours that differentiate good from poor performance) and also the advice of Stevens (2012) who advocates “the anchoring of (competency) definitions with specific and observable behavioural indicators” (p. 12), the researcher in the current study suggests that the focus of the definition of the term competency should be on the actual behaviours that constitute optimal performance and enable the successful achievement of the results for which the job exists. Thus, a competency definition in the UK tradition will be endorsed, more specifically that of Bartram (2005, p. 1187) who describes competencies as “sets of behaviours that are instrumental in the delivery of the desired results or outcomes.” Although the current study defines competencies as referring to actual observable behaviour, these behaviours are nonetheless still regarded as the observable denotations of an abstract (behavioural) construct<sup>23</sup> or latent variable. The current study therefore interprets the connotative meaning (Kerlinger & Lee, 2000) of a competency as the abstract behavioural theme that underlies a bundle of behaviours and the denotations (Kerlinger & Lee, 2000) of a competency as the specific behaviours that are observable manifestations of the competency/construct. A competency is therefore in essence a behavioural/performance construct.

Having said this, the researcher acknowledges that many authors propose that knowledge, skills, attitudes, motives, beliefs, traits, and other underlying characteristics should also (or should rather) be considered as competencies. However, the current study believes that knowledge, skills, attitudes, motives and beliefs should not be explicitly included as part of the definition of competencies, but rather be modelled as a qualitatively distinct category of latent variables in a competency model. A too-encompassing definition of competencies precludes the possibility of utilising the distinction between latent variables characterising what the graduate does and latent variables characterising who the graduate is for the purpose of explanation. In addition, it is believed that concepts such as traits and underlying characteristics is not what McClelland (1973) had in mind when propagating his competency approach – these should rather be regarded as innate to the individual or an individual’s potential to perform certain behaviours well – and is argued to logically fall within a different domain of a competency model (See Figure 2.1 below). Thus, it is suggested that the definition of competencies be further broadened and revised: *the abstract themes underlying sets of behaviours that are instrumental in the delivery of the desired outcomes and that are influenced by knowledge, skills, abilities, motives, beliefs, individual traits and/or underlying individual characteristics* or competency potential (Bartram, 2005).

---

<sup>23</sup> A construct is an abstract representation of a real world phenomenon that exists in the mind of man (Kerlinger, 1986) and cannot be pointed to or measured directly (Viswesvaran & Ones, 2000). In order to validate a construct or set of interrelated constructs (e.g. a theory) and substantiate its inferred nature, it is firstly necessary to provide a theoretical definition that is capable of fully accounting for the real world phenomena it is aiming to describe or explain.

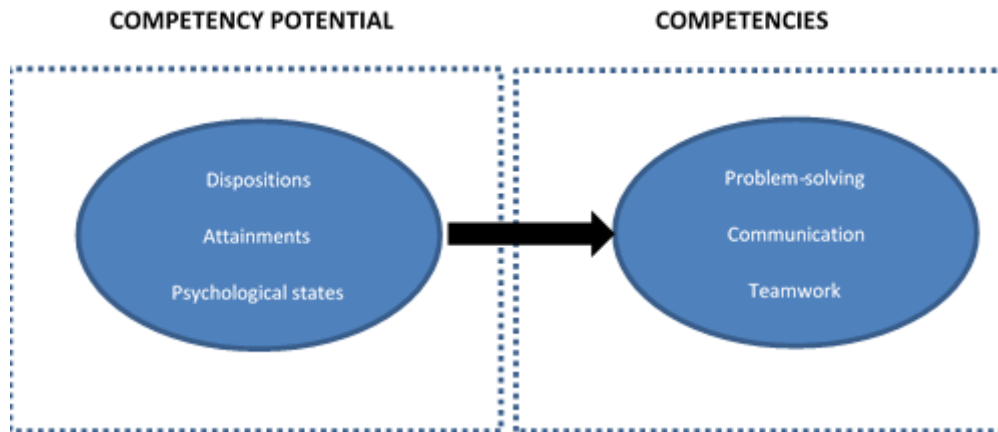

Figure 2.1. Distinguishing competency potential and competencies as two different domains of a competency model

Secondly, and as was said previously, it is postulated that the performance levels of graduates are determined by a complex nomological net comprising the various person-centred and situational determinants of performance that are structurally inter-related. Moreover, it was stressed that performance should be conceptualised as a structurally interrelated set of competencies and outcome latent variables. This implies that different performance determinants (e.g. competency potential latent variables and situational latent variables) relate structurally to each other and to the competencies but then indirectly also to performance outcomes, like a chain of cause-and-effect variables that is “hidden” in nature (i.e. lies in Babbie and Mouton’s (2001) World 2). It is therefore unlikely that the identification of a list or a dictionary of desirable competencies is adequate for the purposes of this research. Thus, a competency domain is proposed as part of a competency model that explicitly maps the different competencies that (along with the outcome latent variables) constitute the performance construct and also the nature of their associations with each other.

Thirdly, if the goal of the research is to conduct an in-depth analysis of graduate leader performance (competencies and outcomes) as a multiple and differentiated criterion (e.g. to truly delve into and explore the construct – e.g. what is the connotative meaning of the graduate leader performance construct?) it is argued that a broader, more advanced conceptualisation of a competency model would be beneficial, more specifically one that also caters for an outcome domain. Bartram (2005) refers to this as ‘competency results’<sup>24</sup> that is in itself a structural model, depicting the different components of graduate leader outcomes as a separate domain and how

<sup>24</sup> “The actual or intended outcomes of behaviour, which have been defined either explicitly or implicitly by the individual, his or her line manager or the organisation” (Bailey, Bartram & Kurz, 2001, p. 6).

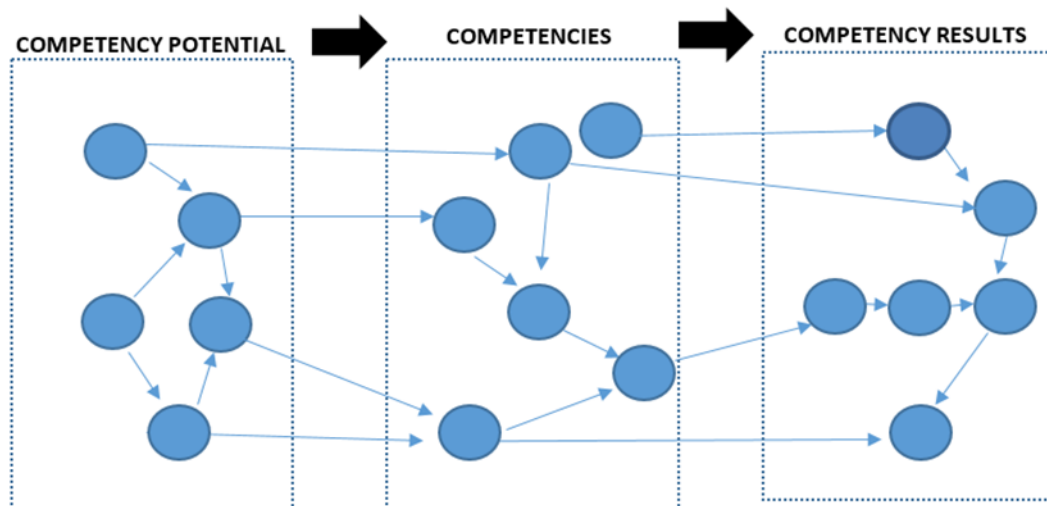

Figure 2.2. A graphical representation of a chain of cause-and-effect relationships between variables mapped in a 3-domain competency model

Fourthly, it is important to note that employees do not act in a vacuum. Depending on the work environment and context, there could be certain “facilitators” available to the employee that will assist him or her in efforts or indeed also “obstacles” that might make it more difficult for an employee to behave optimally. This argument also supports Bartram’s (2005) approach to competency models, namely that it is posited that certain environmental factors influence individuals to behave in certain ways. In this regard, Bailey, Bartram and Kurz (2001, p. 5) make reference to competency requirements as well as contextual and situational factors, with the former referring to “the demands made upon individuals within a work setting to behave in certain ways and not to behave in others” (i.e. the line manager setting goals for an employee) and the latter to other factors in the workplace that “act to direct an individual’s effort and affect the individual’s ability to produce the desired sets of behaviour” (i.e. organisational structure, job characteristics, remuneration systems, etc.).

Thus, it is argued that competency requirements can exert a main effect on the success with which competencies are displayed at work. Moreover, it is proposed that different latent variables that define the work environment can exert a main effect on the success with which competencies are displayed at work and also further moderate the impact of competency potential latent variables on the level at which competencies are displayed at work. Similarly, it is argued that latent variables that define the work environment can exert a main effect on the outcome (i.e. competency results) latent variables as well as moderate the impact of competencies on outcomes. As these main or moderating effects impact on the level of success with which competencies are displayed at work and also the outcomes achieved at work, the inclusion of both a competency requirements as well as a situational/contextual factors domain is believed to be another important addition to the study and development of competency models. This line of reasoning is depicted in Figure 2.3.

The argument thus far assumed an essentially unidirectional, albeit complex, causal flow in which competency potential latent variables and situational characteristics affect the level of competence that is achieved on competencies, which in turn, affect the standards that are achieved on the outcome latent variables. It seems unlikely, however, that employees (and even possibly the nature of the organisational environment) will remain psychologically unaffected by the success or failures achieved on the outcome latent variables. It seems more likely that feedback loops should exist through which specific outcome latent variables affect specific (malleable) competency potential latent variables and specific (malleable) situational latent

variables. Alternatively, one should think in terms of a longitudinal competency model in which the level of the outcome latent variables at time 1 affect the levels of specific competency potential latent variables and situational latent variables at time 2.

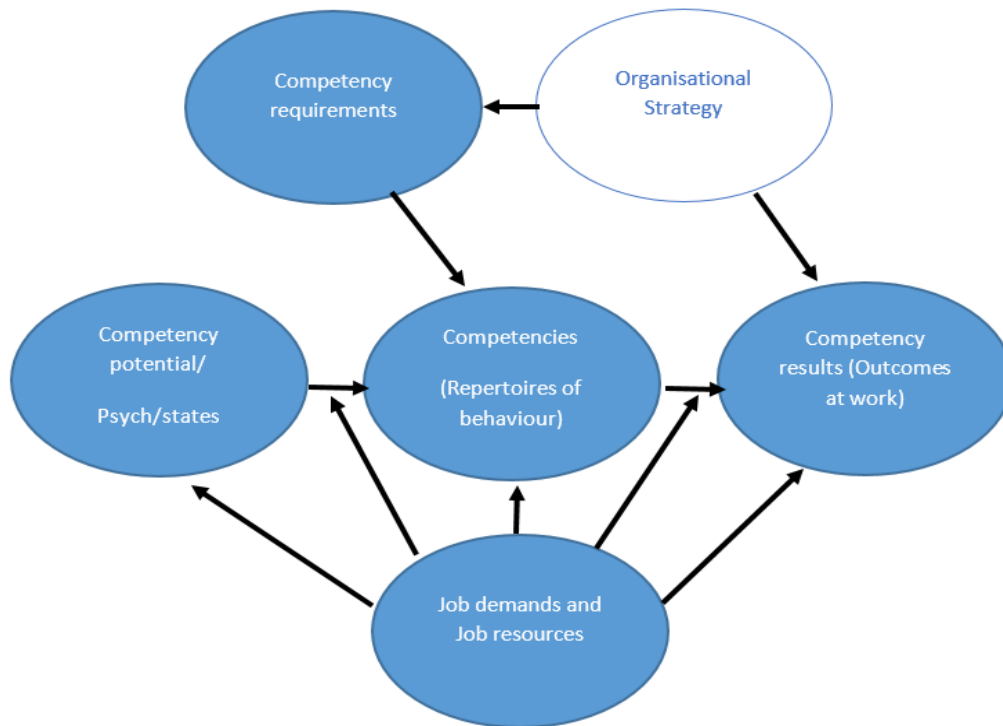

Figure 2.3. A five-domain representation of a competency model

Finally, during the past three decades, there has been an increase in interest regarding the impact that job characteristics can have on employee well-being (Bakker & Demerouti, 2007) such as on employee levels of burnout and work engagement but also on job performance. For example, in exploring the antecedents of employee well-being and building on previous job stress models such as the demand-control model (Karasek, 1979) and the effort-reward imbalance model Siegrist (1996), Demerouti, Bakker, Nachreiner and Schaufeli (2001) developed a theoretical model (the Job Demands-Resources model) that can be used to describe how work demands and resources can affect work-related well-being outcomes, such as burnout/disengagement and engagement (e.g. psychological states). Despite the fact that the Job Demands-Resources (JD-R) model is also aimed at explaining variance in job performance across employees, there has been seemingly very little if any theoretical cross-pollination between competency modelling and the JD-R model. The question for the current study is therefore whether the JD-R model brings any insights that could enrich the manner in which a competency model is interpreted.

Being “arguably the dominant stressor-strain model in the literature today” (Searle & Lee, 2015, p. 47), the model describes job demands as work characteristics that require expenditure of energy and effort, that could lead to strain including burnout, whilst **job resources** are described as work factors that stimulate personal growth, directly aid in the achievement of work outcomes or goals, and that moderate the impact of job demands on physiological and psychological well-being (Bakker & Demerouti, 2007) – see Table 2.3 below for examples of different job resources and job demands.

Table 2.3

*Examples of job demands and job resources for Generation Y Graduates*

<b>POSSIBLE GEN Y WORK DEMANDS</b>	<b>POSSIBLE GEN Y WORK RESOURCES</b>
Computer (connectivity) problems	Workspace flexibility
Interpersonal conflict	Rapid career advancement opportunities
Remuneration	Work-life balance
Role conflict	Constant feedback
Time pressure	Portfolio of employability skills
Paternalistic leadership climate	Social work environment
Victimisation	Overseas travel

Maybe more importantly, the model describes two distinct underlying psychological processes that lead to two different psychological states,<sup>25</sup> namely: 1) a motivational process (e.g. jobs that are optimally designed and contribute to the individual's intrinsic and extrinsic motivation) leading to job engagement (Bakker & Demerouti, 2007) and consequently to an increase in job performance; and 2) a health impairment process (e.g. poorly designed jobs or chronic job demands such as work overload which exhaust employees' mental and physical resources and may lead to the depletion of energy) that could lead to exhaustion, burnout, and eventually, a decrease in job performance (Bakker & Demerouti, 2007) – see Figure 2.4 below. Research has also pointed to the fact that job engagement and job burnout can both be outcomes as well as determinants of job demands and resources (Bakker & Demerouti, 2007). According to the JD-R model the feedback effect of job engagement and job burnout on job resources and job demands is mediated by job crafting. That is to say that employees who experience disengagement may, as a result of their own (negative) behaviour, create additional demands and fewer resources and in a similar vein, engaged employees may employ more positive behaviours and consequently be able to perceive more resources and be better able to mobilise their resources (Bakker & Demerouti, 2007) in consequent performance cycles. Thus, over and above the fact that engagement and/or disengagement have a direct impact on performance outcomes, these psychological states may indeed also have a bearing on future performance efforts by way of entrenching and/or intensifying negative or positive behavioural patterns at work if they remain unchecked.

Some final thoughts to take cognisance of here is the role that job crafting<sup>26</sup> plays in regulating employees' demands and resources in the workplace so as to bring the situation closer to their preferences (Petrou, Demerouti, & Schaufeli, 2015), and also personal resources, defined as "aspects of the self that are generally linked to resiliency" (Hobfoll, Ennis, Johnson, & Jackson, 2003, p. 632) that may explain how "individuals differ in their well-being despite exposure to similar job demands and resources" (Searle & Lee, 2015, p. 47).

<sup>25</sup> It might not be that an employee is completely engaged or completely burnt-out at any particular stage, but that they may find themselves on a continuum between the two states, depending on how the job is structured and/or changes in structure.

<sup>26</sup> Wrzesniewski and Dutton (2001) suggested that employees actively use job crafting to alter the task boundaries of their jobs (number and type of activities), the cognitive task boundaries of their job, (how they see the job) and the relational boundaries of their job (whom they interact with at work) in an effort to bring the job demands more in alignment with what they can bring to the job.

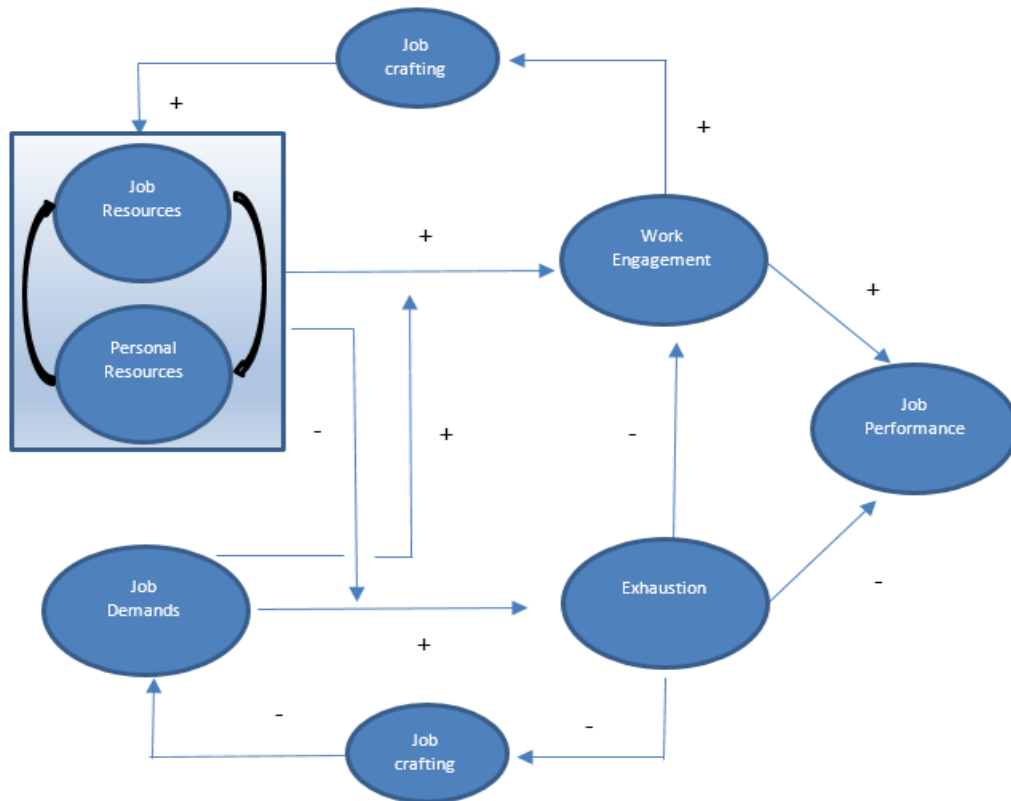

Figure 2.4. *The Job Demands-Resources model. Reprinted from Work and Wellbeing: A Complete Reference Guide, by Bakker, A.B., & Demerouti, E., 2014, p. 10. Copyright 2014 by John Wiley & Sons.*

The idea that employees have personal (psychological) resources that influence their psychological state, as well as that situational/contextual job characteristics could add to or diminish from that optimal psychological state, which in turn could influence job performance can be an attractive addition to the study and development of competency models. The JD-R model may also “be applied to various occupational settings, irrespective of the particular demands and resources involved” (Bakker & Demerouti, 2007, p. 321) and as such can also be extended to the study of graduate leader job performance. This, however, raises the question how the insights brought by the JD-R model should be accommodated in one’s interpretation of a graduate leader competency model.

Both the JD-R model and the 5-domain competency model acknowledge the role of person characteristics and situational characteristics on job performance. The JD-R model adds value to the 5-domain competency model by distinguishing between job demands and job resources as two distinct sets of situational latent variables. The 5-domain competency model in turn could enrich the JD-R model through its distinction between job competencies and outcome latent variables as facets of job performance. Most importantly though for the purpose of the current study is the JD-R model’s flagging of the important role that psychological states play in the psychological mechanism that regulates employee performance. In the literature it is generally recognised that employee engagement (Bakker & Demerouti, 2007), psychological ownership (Pierce & Jusilla, 2011), psychological empowerment (Spreitzer, 1995), organisational commitment (Tolentino, 2013), job satisfaction (Judge et al., 2001), and burnout (Manochehri & Malekmohammadi, 2015) are psychological states that play a significant role in determining job performance.

Psychological states are relatively transient psychological conditions that characterise the employee at a specific point in time. Instead of solely focusing on the inclusion of dispositions and



attainments as job competency potential latent variables, it is proposed that *psychological states* (which can fluctuate and change between different jobs and points in time) should also be included under the umbrella of competency potential. Although the JD-R model does not formally acknowledge this, the question should nonetheless be asked whether these psychological states that characterise employees at any given point in time do not arise, at least in part, from the level of performance that they achieve. It seems psychologically implausible that these psychological states could be maintained in the absence of at least satisfactory performance. At the same time, it is acknowledged that the context in which the performance is achieved (the job characteristics, for example) and the personal resources (the roots of psychological ownership for example (Pierce & Jusilla, 2011) or achievement motive (McClelland, 1961)) are of sufficient importance to allow performance to affect psychological states in this manner. Porter and Lawler's (1968) interpretation of the expectancy theory on motivation suggests that the psychological state of job satisfaction flows from job performance but at the same time also determines performance through its feedback effect on the expectancies and valences associated with performance and with performance outcomes. This line of reasoning suggests that rather than interpreting psychological states as competency potential they should rather be treated as outcome latent variables. It should, however, be kept in mind that outcome latent variables (or competency results) form part of the job performance construct and therefore should be confined to those results that the employee is expected to deliver through displaying competence on the job competencies. The position that psychological states and other malleable competency potential latent variables (as well as malleable situational latent variables, like a high-performance culture) develop through performance is therefore perhaps best captured through feedback loops from the competency and outcome domains to the competency potential domain.

For the purposes of this research therefore and in positing a broadened version of Bartram's (2005) competency approach that is integrated with the concept of a structural model (Diamantopoulos & Siguaw, 2000), a competency model can consequently be defined as follows (see Figure 2.5 below): A multiple-domain, job performance hypothesis,<sup>27</sup> in which the latent variables in relevant domains are structurally mapped on each other in a chain of cause-and-effect relationships and where the domains in question are competency potential, (i.e. IQ, personality, psychological state, etc.), competencies (the desired behavioural repertoires), competency outcomes (work outcomes), competency requirements (implicit and explicit norms and values guiding behaviour and that are derived from organisational strategy), and job and organisational characteristics (resources or demands that, as main effects or in interaction with competency potential latent variables or in interaction with competencies, increase or diminish an individual's psychological state, demonstration of behaviours, and achievement of important work outcomes).

---

<sup>27</sup> Once the structural model has empirically been shown to fit data (i.e. the close fit null hypothesis has not been rejected) and the path coefficient estimates have been shown to be statistically significant ( $p < .05$ ) (assuming close measurement model fit, statistically significant ( $p < .05$ ) and large completely standardised factor loadings and statistically significant ( $p < .05$ ) but small completely standardised measurement error variances), a competency model in the sense that it is defined here may be regarded as a performance theory (Kerlinger & Lee, 2000).

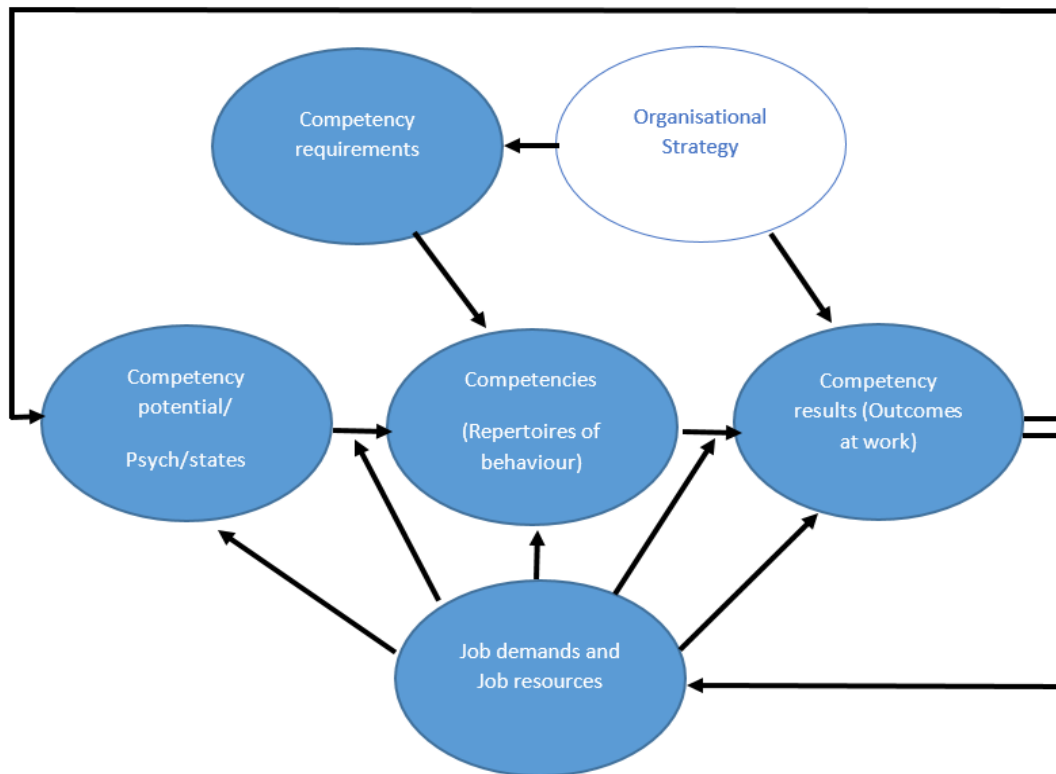

Figure 2.5. A five-domain representation of a competency model (full version)

### 2.3 THE JOB PERFORMANCE CONSTRUCT

The objectives of the current study derived in Chapter 1 were:

- To explicate the connotative and denotative meaning of the competency domain of the generic graduate leader performance construct;
- To develop the Pienaar Graduate Leader Competency Questionnaire (PGLCQ) that can be used to obtain multi-rater assessments of the competency domain of the graduate leader performance construct;
- To evaluate the reliability and construct validity of the PGLCQ by evaluating the fit of the measurement model implied by the architecture of the questionnaire, the constitutive definition of the generic graduate leader performance construct and the multi-rater nature of the PGLCQ;<sup>28</sup> and
- To evaluate the construct validity of the performance measure by evaluating the fit of the structural model reflecting the internal structure attributed in terms of the conceptualisation of the construct to the generic graduate leader performance construct.

Explicating the connotative meaning of the generic graduate leader performance construct is a necessary prerequisite to identify a sample of denotations for the development of the PGLCQ. This is why the current study requires at the outset the development of a partial generic graduate leader competency model (i.e. more specifically a performance domain structural model)<sup>29</sup> – the

<sup>28</sup> Once the GLOQ is available it will be possible to evaluate the construct validity of the GLPB more stringently by fitting the structural model implied by the constitutive definition of the graduate performance construct.

<sup>29</sup> I.e. a structural model that identifies the latent competencies and latent outcomes that constitute performance and that describes the manner in which these latent variables are structurally interlinked.

underlying goal being to evolve a more credible and valid conceptualisation as to what constitutes the job performance of Generation Y graduates.

Yet, despite the importance of the construct of job performance on companies' and countries' bottom line results and its centrality (Varela & Landis, 2010) in the Human Resource Management field, there is no simple and widely agreed-upon definition thereof to be found in the literature (Arvey & Murphy, 1998) and "considerable disagreement has characterised the dialogue regarding its appropriate conceptualisation" (Varela & Landis, 2010, p. 625). The inability to offer a suitable and valid theoretical definition of the construct of job performance would impede the current endeavour to develop a construct valid operationalisation of the graduate leader job performance construct. This is why it is necessary to review the manner in which the job performance construct has been conceptualised in the literature at least as a point of departure. Insights gained via the literature review will then be used to advance the current research study's own constitutive<sup>30</sup> definition of the construct, without which the proper research operationalisation cannot occur and consequent connections to empirical phenomena in nature necessary to permit empirical theory testing are not possible.

With regard to past conceptualisations of the construct, it is important to note that up until the 1990s, job performance was typically viewed as an unidimensional construct (Campbell, McCloy, Oppler, & Sager, cited in Borman & Schmitt, 1993) and the study and assessment of individual work performance focused exclusively on the outcomes that were achieved at work (Campbell, cited in Dunnette & Hough, 1990; Hunt, 1996; Viswesvaran & Ones, 2000). According to this narrow view of job performance, "productivity (quantity) and quality of the goods produced or services delivered by the workers, i.e., goals that are often part of formal job descriptions" (Schaufeli & Taris, cited in Peccei & van Veldhoven, 2015, p. 22) were regarded as the definitive measures of individual success at work. As the outcomes that constitute individual performance were believed to be different for every job (Koopmans, Bernaards, Hildebrandt, Schaufeli, de Vet, & van der Beek, 2011), countless (proxy) measures of job performance were utilised in various settings (Tubre, Arthur, & Bennett, cited in Bennett, Lance, & Woehr, 2006) instead of pursuing a more in-depth understanding of the job performance construct itself (Chan, 2005). That is to say that in order to pronounce a verdict on whether or not an employee was performing at work, researchers and practitioners would simply turn to available outcome performance measures (often documented in formal job descriptions) such as absenteeism or number of units produced to inform their decisions without questioning whether such measures provide a true, content valid reflection of the job performance domain. This traditional outcome view on job performance can be succinctly summarised by the opinion of Kane (cited in Berk, 1986, p. 237) who at the time, defined job performance as "the outcomes achieved in carrying out the job function during a specified period". This approach posed<sup>31</sup> two challenges, both of which relate to the use of contaminated or limited information because of its convenience of availability. Firstly, by using this narrow definition of job performance only a part of the performance construct was measured but not the construct in its entirety (i.e. as a richly interconnected multidimensional construct the connotative meaning thereof is not located in a specific location but lies in the structural network of relations and the levels of all the latent variables comprising the network as a whole) and secondly, contaminating factors were included in the measurements that were not under an individual's control. Moreover, it has since been correctly argued that outcome measures such as productivity and efficiency more often than not prove inadequate in providing a valid assessment of an employee's true worth to an organisation (Campbell, et al., cited in Borman & Schmitt, 1993;

---

<sup>30</sup> The underlying goal will be to provide a valid theoretical definition of the job performance construct that also aligns with the current study's interpretation of competency models and competency modelling. The preceding discussion of the various domains comprising a competency model as viewed from the perspective of the current study has in passing also revealed the current study's standing on the conceptualisation of the performance construct.

<sup>31</sup> Over and above these two challenges, the fixation on the measurement of outcome performance (as an undifferentiated criterion) made it difficult to move away from a "traditional prediction paradigm which assumed a bivariate linear relationship between (performance) predictors and (performance) criteria" (Chan, 2005, p. 221).

Pritchard, cited in Dunnette & Hough, 1992). This is because of the existence of situational characteristics (i.e. economic downturn, brand loyalty, etc.) that could facilitate or inhibit an employee's ability to achieve specific work objectives (Sonnetag, Volmer, & Sychala, cited in Barling & Cooper, 2008). In other words, high levels of competence with regards to the necessary behavioural competencies displayed at work (e.g. planning or selling) may or may not<sup>32</sup> coincide (Schaufeli & Taris, cited in Peccei & Veldhoven, 2015) with high levels of work outcomes (e.g. meeting project deadlines or number of sales made) but this should not make high levels of proficiency with regard to the required behavioural competencies displayed at work less valid or valued.

Consequently, many authors have acknowledged that the job performance construct should be broadly conceptualised as comprising both a process component (i.e. behavioural) and an outcome component (Borman & Motowidlo, cited in Borman & Schmitt, 1993; Campbell, et al., cited in Borman & Schmitt, 1993; Roe, cited in Cooper & Robertson, 1999). The emphasis, however, was placed on the behavioural component. In fact, many researchers were swayed by the promise of the emergent behavioural component of the job performance construct, resulting in appeals for rewarding employees for displaying certain behaviours at work (Campbell, et al., cited in Borman & Schmitt, 1993), instead of for the achievement of specific job outcomes. For example, Campbell (cited in Dunnette & Hough, 1990, p. 704) was of the opinion that "performance is behaviour. It is something that people do and is reflected in the actions that people take ... performance is not the consequence(s) or result(s) of action; it is the action itself." In a similar vein, Hunt (1996, p. 52) interpreted job performance as the "actions or behaviours relevant to the organisation's goals." Thus, a behavioural view of the job performance construct emerged broadly advocating that job performance equates to actions or behaviours at work that can be scaled, that are linked to an organisation's goals (Campbell, et al., cited in Borman & Schmitt, 1993), and that are under the control of the employee – i.e. excluding behaviours that are constrained by the environment (Rotundo & Sackett, 2002).

As it is believed that both the outcome and behavioural views each offers distinct yet compatible contributions to the debate, the current study adopts an integrated approach to the conceptualisation of job performance. That is to say that job performance will be interpreted throughout this study as behaviours that are instrumental in achieving outcomes, as well as the achievement of outcomes that are valued by the organisation. This interpretation is in line with the views of Miles, Borman, Spector and Fox (2000) who call for acknowledgement that the job performance construct concerns the output of one's actions, as well as the behaviours that are engaged in, in order to produce these outcomes and also to a certain extent, the views of Viswesvaran and Ones (2000, p. 216) who define job performance as "scalable actions, behaviours and outcomes that employees engage in or bring about, that are linked with and contribute to organisational goals".

An outcome domain is specifically included in the current study's conceptualisation of job performance as, despite earlier criticism,<sup>33</sup> in the final analysis, the sole reason for the creation of jobs is to achieve or deploy an organisation's strategy. After all, "a job is conceived of as a collection of behaviours connecting positions with organisational goals" (Varela & Landis, 2010, p. 628). Put differently, the bottom line is still what really matters – "(job) performance is what the organisation hires one to do and do well" (Bartram, 2005, p. 1186) – and for this reason

---

<sup>32</sup> It is generally accepted that behaviours are *instrumental* in achieving specific work outcomes, but they are not the only variables impacting the achievement of outcomes at work.

<sup>33</sup> The fact that outcome criterion measures tend to be influenced by contextual factors that are beyond the control of the employee, either as main effects or in interaction with the latent behavioural competencies, is formally acknowledged in a comprehensive 5-domain competency model as defined earlier. When employee performance on the latent outcome variables is low the 5-domain competency model allows the testing of diagnostic hypotheses to determine whether the inadequate outcome performance is due to incompetence on the latent behavioural competencies (for which the employee can be held accountable) or to contextual factors that are beyond the control of the employee (for which the employee cannot be held accountable).

undeniably any conceptualisation of job performance should always incorporate the end results or desired work outcomes for which a job was created in the first place. However, as the behavioural and outcome components of job performance are to a degree<sup>34</sup> empirically related (Sonnetag, et al., cited in Barling & Cooper, 2008) and the addition of the *process performance* perspective to this debate provides complimentary substance as to what constitutes success in the workplace, the behavioural (e.g. process) view on performance also cannot be ignored. That is to say that employees who display high levels of competence with regard to the behavioural competencies linked to their job roles should also be seen as high performers, even if the successful enactment of these competencies do not necessarily always result in the achievement of the desired (level of) outcomes at work.

Finally, with the call to action to uncover or explicate the job performance construct (Carpini, 2017; Chan, 2005) – in other words looking at the phenomenon from a connotative (i.e. nomological or structural) viewpoint – it must be said that any conceptualisation of job performance also needs to give consideration to the abstract plane around which the proper study of the construct revolves – i.e. a nomological network of related cause-and-effect latent variables that structurally relate to each other in a “cunning” configuration “hidden” in nature. This is because in the end “a more penetrating understanding of what success in a specific job (or family of jobs) means would be achieved if the manner in which latent behavioural performance dimensions affect each other and (also) how they affect the latent outcome variables could be formally modelled as a performance structural model” (Myburgh, 2013, p. 21). In proposing then what is regarded by the researcher as a more progressive definition of the (graduate leader) job performance construct and one that also aligns with the longer-term endeavour to use a competency model approach to the development and testing of a graduate leader job performance hypothesis, the following definition will be endorsed throughout this research study:

(Job) performance is the nomological network of structural relations existing between an interrelated set of latent behavioural performance dimensions (abstract representations of bundles of related observable behaviour) and an interrelated set of latent outcome variables valued by the organisation and that contribute to organisational goals (Myburgh, 2013, p. 22).

Implicit in the definition provided above is that it is necessary to measure both the latent behavioural performance dimensions as well as the latent outcome variables in order to comprehensively<sup>35</sup> evaluate an employee’s performance at work. Moreover, job performance according to the above definition does not merely refer to the successful demonstration of competencies linked to a job role, nor merely the achievement of the desired job outcomes, but rather the extent to which an employee is able to successfully align high levels of competence with regards to behavioural competencies linked to their job role with the achievement of objectives for which they were contracted for in the first place. Thus, the “meaning of (graduate job) performance is spread over the whole of the performance structural model” (Myburgh, 2013, p. 22) and cannot be fully understood by examining any single individual performance dimension alone or smaller subsets of performance dimensions in isolation (see Figure 2.6 below).

---

<sup>34</sup> “There is no complete overlap as the outcome component of performance is not affected by the behavioural component of performance alone (Sonnetag et al., cited in Barling & Cooper, 2008) but also to an extent by situational factors. This phenomenon is also acknowledged by a competency approach to job performance hypothesis testing, which proposes the existence of a competency requirements domain and a situational factors domain as part of an overall model representing the situational factors that can impact on competencies as well as competency results (outcomes at work).

<sup>35</sup> Initially only a part of the partial graduate competency model will be used as the foundation for the development of the PGLCQ designed for the purpose of measuring the level of competence that graduates achieve at work on the graduate competencies. The GLOQ will be developed later, and in combination with the PGLCQ, will provide a comprehensive measure of the graduate performance construct in the form of the GLPB.

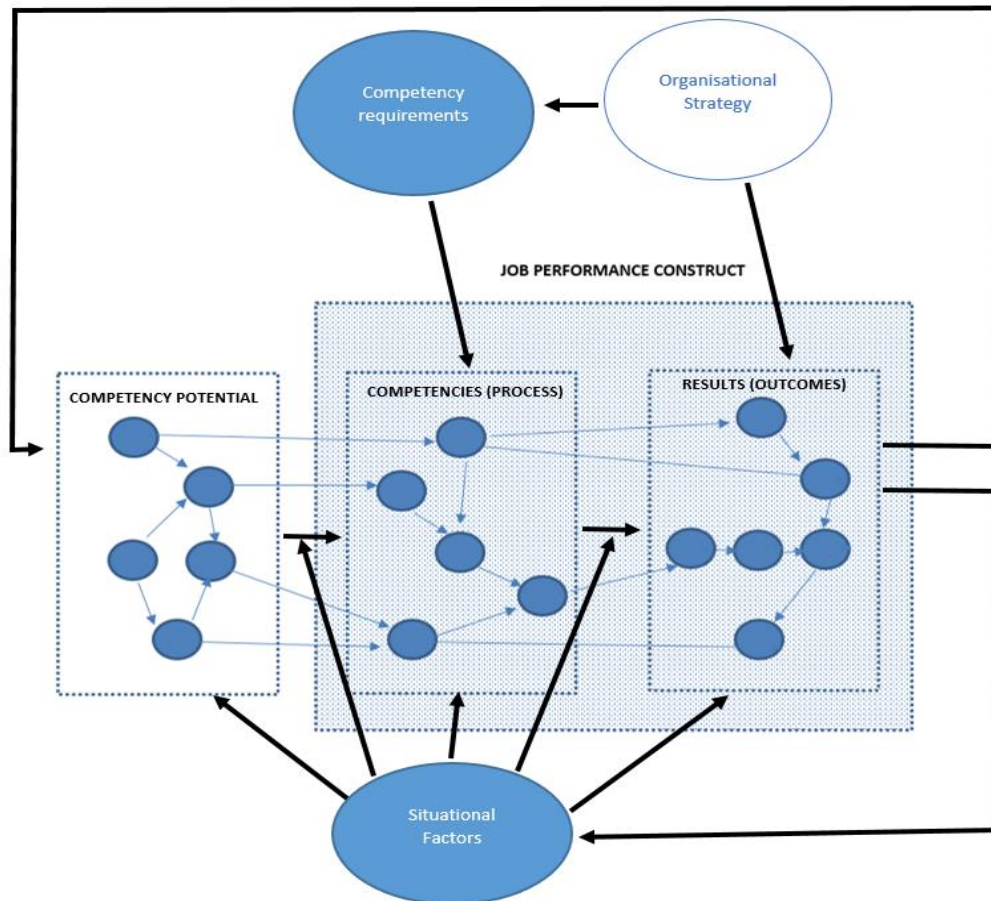

*Figure 2.6.* The construct of job performance conceptualised as a partial competency model embedded in a comprehensive competency model

The current study is arguing in favour of this comprehensive conceptualisation of the job performance construct given its longer-term intention to develop a (partial) explanatory structural model that will provide a valid description of the psychological mechanism that regulates differences in performance across graduates. The purpose of the model is to inform proactive and reactive attempts to influence the performance levels of graduates. Such proactive and reactive interventions have to focus both on the competencies and the outcome variables and their determinants. It is thereby, however, not implied that both competencies and outcomes need to be measured in all instances where information on job performance is required. For the purpose of a validation study, for example, it would still make sense to utilise a composite criterion measure derived from assessments of the latent behavioural competencies. Likewise, for the purpose of incentivising performance the preceding arguments would suggest that it makes sense to restrict assessment to the latent behavioural competencies. In contrast, when viewed from a broader performance management perspective, it would be short-sighted not also to evaluate employees' standing on the latent outcome variables and to forfeit the opportunity to diagnose the causes of poor outcome performance, should that be the case, from the larger comprehensive competency model. Given the objectives of the current study to conceptualise the graduate performance construct (behaviourally) and to develop and validate the PGLCQ, it would nonetheless be necessary to explicate the partial competency model that maps the latent competencies on the latent competency results. The connotative meaning of the graduate performance construct, even when interpreted behaviourally, lies not only in the internal structure of the construct but also in the manner in which the construct is embedded in a larger nomological network of latent variables. To develop such a performance hypothesis, it would

moreover be sensible to firstly direct efforts towards the explication of the competency results (or outcome) domain of graduates, (i.e. the dependent variables) which in turn will serve to inform the identification of the abstract bundles of behaviours or competencies (i.e. the independent variables) that are instrumental in the achievement of the desired graduate (leader) work outcomes.

## 2.4 THE JOB OF A GRADUATE: A WORK IN PROGRESS

The foregoing argument approaches the question on the outcomes for which an employee should be held accountable for from a generic perspective. In the current study the question should, however, also be posed what do organisations aspire to achieve with the graduates they select into the organisation or onto a graduate development programme. In this regard, the identification, appointment and development of graduates as future leaders in South African organisations is what is of particular interest to the present study,<sup>36</sup> rather than an investigation into the specific individual objectives that are unique and associated with each graduate's specific job upon organisational entry. That is to say that the current study supports the views of Bhatnagar (2008, p. 20) who opts for "home-grown" talent to counter the current "leadership crisis" and Boudreau and Ramstad (2005, p. 129) as well as Van Rooyen and Whittle (2011), who favour pivotal talent pools and more exclusive talent management approaches directed at a small percentage of the workforce<sup>37</sup> – i.e. 'treatment' given to high-potential employees that would make the biggest difference to organisational success by eliciting leadership potential and unleashing leadership as a catalyst for improving managerial effectiveness and efficiency.

Nonetheless, it must be acknowledged that when graduates enter an organisation they are first and foremost appointed and deployed in various entry-level positions that contribute to the organisation's bottom-line, that directly connects their contributions to organisational goals in a system in which they participate as followers, and that justifies, and is aligned with, the salaries they are paid on a monthly basis (i.e. an individual contributor role). Thus, like any other employee, graduates are undeniably appointed in a job as individual contributors that they are paid for and the expectation is that they will do that job well even though their tenure there might be of a temporary nature. Moreover, their individual contributions – the performance (i.e. behaviours and the results)<sup>38</sup> they achieve while in these roles – will be closely scrutinised by their supervisors or managers, as well as the HR team.<sup>39</sup>

However, when graduates enter the organisation, they also become part of a (temporary) graduate development programme with the purpose of developing them into leadership positions in a shorter period of time (Doherty et al., 1997). In South Africa these programmes typically last between 24 and 36 months<sup>40</sup> and the direct costs associated with the running of them can go up to R 1 million per annum (SAGEA, 2014) in some extreme cases. The direct and other indirect costs (i.e. the time of trainers, time taken to mentor graduates, training materials, accommodation costs, etc.) associated with the running of a graduate development programme puts pressure on the business to be able to realise a return on investment, resulting in graduates

---

<sup>36</sup> As was argued in Chapter 1, graduates represent one major talent pool for creating leadership bench strength.

<sup>37</sup> This is not to say that the current study is opposed to more inclusive views on talent development and the creation of customised developmental pathways for all employees.

<sup>38</sup> Although the successful enactment of this role is important, it is not deemed paramount to a graduate's future job performance as will be explained shortly.

<sup>39</sup> Therefore it would be possible, and even desirable, to also develop and empirically test a comprehensive 5-domain competency model for these entry-level positions that would explicate the latent competency results that they are expected to achieve, the latent competencies that, along with latent situational characteristics, determine the standard of performance that they achieve and the latent competency potential variables that, along with latent situational characteristics, determine the level of competence that they achieve on the job competencies. This is, however, not the objective of the current study.

<sup>40</sup> 55% of SAGEA members indicate their programmes last 2 to 3 years (SAGEA Employer Survey, 2014).

to some extent, being released from their formal job duties<sup>41</sup> in order to attend classes or training events, to experience job rotations, complete assignments, or to meet with mentors, coaches or trainers. This does not mean that graduates are entirely exempted from formal duties and responsibilities in general. In fact, under these conditions graduates are actually given an additional set of responsibilities relating to the success with which they mature, learn, develop and maximise the use of opportunities they are presented with while completing these programmes.

There is therefore a *second role* that graduates are required to fulfil and in which they need to perform in terms of learning, acclimatisation, and holistic (leadership) maturation. Moreover, as it is the aim to eventually deploy graduates into permanent senior, strategic roles in the business, it can be argued that the *graduate programme role* is the primary reason that graduates are appointed in the first place – i.e. the graduate is required to practise and perfect those competencies (and develop malleable competency potential) during the graduate programme that will also be in operation<sup>42</sup> when having to perform the *future leadership role* when appointed into a full-time management position and where they need to accept responsibility for the outcomes associated with that position. The ideal no doubt would be that many of these competency latent variables (and possibly other competencies as well as malleable competency potential) in support of leadership effectiveness and employability in general should have been developed to sufficient levels during their graduate and postgraduate years at university. As argued in Chapter 1, however, this unfortunately is all too frequently not the case, possibly because leadership potential specifically can only “be revealed and assessed through (real-life) experiences in the field” (Brownell, 2006, p. 310) – i.e. leadership competencies are born out of “character” that develops by working through *crucibles* (Brownell, 2006, p. 318) and cannot come to full fruition “within the limited time frame of the business curriculum or properly assessed under traditional classroom conditions”. A productive way of interpreting the above would be to think and argue in terms of a longitudinal comprehensive competency model, in which the competency variables (and malleable competency potential variables<sup>43</sup>) of the model at time 1 (i.e. during the graduate development programme) are developed and sharpened (through learning) to a sufficient level to be able to successfully perform in a leadership role, which would be represented by the same (partial) competency model at time 2 (when the graduate has moved into a permanent managerial position) embedded in the time 2 larger comprehensive competency model.

Although this also falls beyond the immediate scope of the current study, the preceding line of reasoning suggests the need to have a learning potential (or performance@learning) competency model (Burger, 2012; De Goede, 2007; Prinsloo, 2015; Van Heerden, 2013) sandwiched in-between and articulating with the two sequentially linked/longitudinal leadership competency models as well. It is through learning that the malleable leadership competency potential latent variables with which graduates enter the graduate programme, conceptualised as prior learning (Mahembe, 2014), are developed and enhanced into post-development (time 2) leadership competency potential. In terms of this reasoning, as depicted in Figure 2.7, some of the job competency potential latent variables (e.g. prior knowledge, skills, abilities relevant to the learning task but not restricted to these) comprise the learning competency potential latent

---

<sup>41</sup> It is acknowledged the release of graduates from their formal job duties also holds cost implications.

<sup>42</sup> It could even be argued that assessments of the demonstration of leadership competencies at the conclusion of the graduate development programme should serve to inform the selection of graduates that are offered full-time, managerial positions upon conclusion of the programme. Therefore, a two-stage selection process for graduates is proposed with the first stage comprising the assessment of (non-malleable) competency potential as a means of establishing entry into the graduate development programme, and the second stage involving the assessment of leadership competencies (and malleable competency potential) upon conclusion of the same programme to inform selection decisions with regard to the permanent placement of graduates into managerial positions.

<sup>43</sup> Although this does not fall within the immediate scope of the study, it is suggested that the graduate programme should also hone the relevant malleable competency potential variables that are in support of future leadership effectiveness, such as the development of social capital, self-efficacy and emotional maturity.



variables as well. Likewise, the learning outcomes (post-development knowledge, skills, and abilities) comprise the job competency potential latent variables that determine the level of competence that the developed graduate, post development, achieves as newly appointed leader. Although the process suggested in Figure 2.7 seems plausible when learning takes place in a formal classroom/programme setting, the process fails to satisfactorily acknowledge that learning is not restricted to the classroom. Rather it is a never-ending growth process that continues through action/experiential learning whilst creating meaningful structure in novel problems encountered on the job by transferring prior knowledge, skills and crystallised abilities onto the novel problem and automating the insight that is derived through transfer (i.e. making it part of the existing knowledge structure).

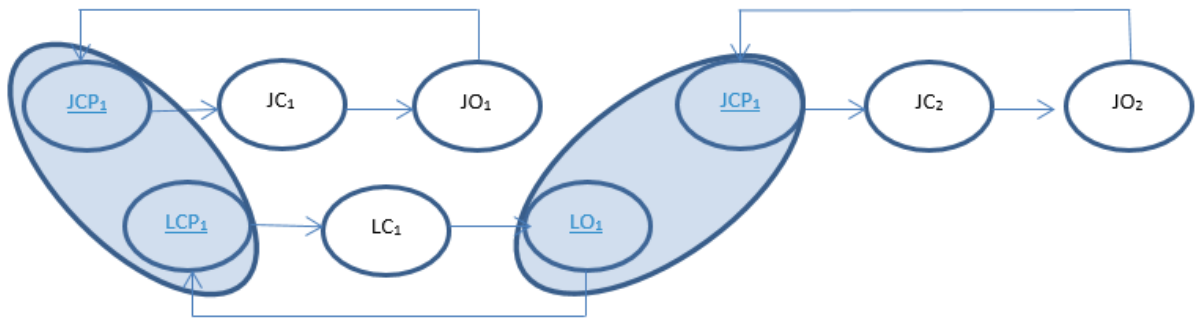

Figure 2.7. A graphical representation of learning in a classroom/programme setting

The question is how to elaborate Figure 2.7 to best capture this position? Given that (action/experiential) learning is seen in terms of this position as an integral part of the behaviours that need to be performed on the job, this would suggest that the learning and job competencies need to be merged in the time 2 competency model. This in turn would suggest that the learning competency potential domain and the job competency potential domain should also be merged in a manner that recognises that these two domains to some degree intersect (i.e. the same latent person characteristics determined job performance and learning performance). The latent job outcome domain should, however, remain a separate domain (psychologically interpreted) and this interpretation feeds back onto the job (and learning) competency potential latent variables to create a dynamic system that has the potential to change over time. The latent learning outcome domain should, in contrast, be dropped and replaced with a feedback loop that allows the learning competencies to directly feed back onto the crystallised knowledge, skills and abilities that acted as job and learning competency potential latent variables. This line of reasoning is depicted in Figure 2.8.

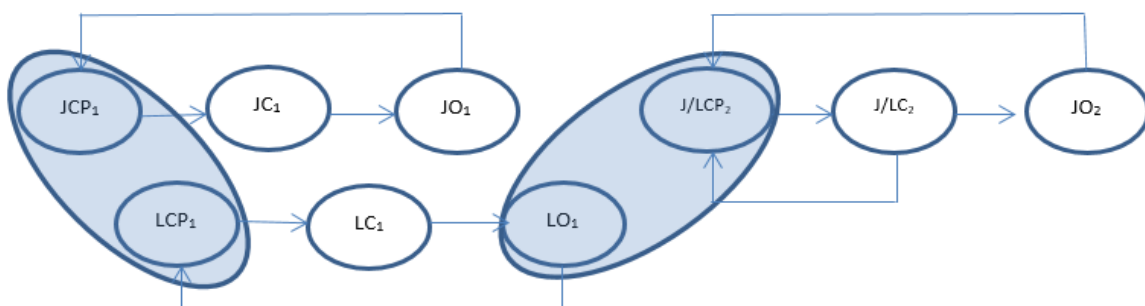

Figure 2.8. A graphical representation of action/experiential learning

The learning potential studies cited above have all focused on learning performance related to academic learning material. To some degree, this also applies to the graduate development programme. Learning on the graduate development programme, however, differs from typical academic classroom learning in that learning about the self is required to a far greater extent. In contrast to the learning potential studies cited above, the proposed longitudinal graduate development competency model will therefore, in addition to the learning competency potential latent variables that have already been identified (Burger, 2012; De Goede, 2007; Mahembe, 2014; Prinsloo, 2015; Van Heerden, 2013) also have to make provision for learning competency potential latent variables that determine the motivation and ability to learn about the self. Learning about the self could in addition comprise additional learning competencies as well.

This line of reasoning points to the need for a review of the literature on leadership effectiveness and as such, the logical starting point for the current study is to review models, frameworks and theories on leadership effectiveness and other related works on managerial job performance requirements for the twenty-first century that have been published previously in an attempt to glean from these firstly, the generic work outcomes (i.e. dependent variables) that can be expected of graduates fulfilling leadership roles in South African organisations and secondly, the competencies (i.e. independent variables) that are likely to explain variance in the aforementioned generic graduate outcomes for the *graduate programme role*. The focus of the study, however, will remain the explication of a competency domain structural model of the South African graduate leader performance construct.

## **2.5 PHILOSOPHICAL DEBATES ON LEADERSHIP**

### **2.5.1 INDIVIDUAL VERSUS COLLECTIVE LEADERSHIP**

If leadership is at the centre of the debate on graduate performance, it follows that contemporary conceptualisations of leadership should serve as the point of departure for the current study. However, before the focus turns to these taxonomies or theories of leadership to be unpacked in more detail, several prominent debates regarding the nature of leadership, which have a bearing on the unfolding explication effort, need to be aired and addressed.

The first of these relates to the clarification as to the proper framework required to study the essence of leadership, insofar as moving beyond the misguided notion of leadership being conceptualised as isolated, role-based actions on the part of individuals that “exogenously” impact organisations (Lichtenstein, Uhl-Bien, Marion, Steers, Orton, & Schreiber, 2006, p. 2). In this regard, prior studies have perhaps contributed to this fallacy and oversimplified the matter by focusing rather exclusively on the contributions of the individual leader (i.e. *who they are, what they do, or how they behave*) in offering an explanation for how a group collective can achieve more than the sum of its parts. However, “to understand leadership behaviour as an organisational phenomenon, one must begin by considering the nature of organisations” (Fleishman, Mumford, Zaccaro, Levin, Korotkin, & Hein, 1991, p. 256), which for this purpose, is perhaps best encapsulated by way of systems theory.

The systems theory broadly holds that organisations compete in a broader external environment with others by way of a transformative process during which human and physical resources are extracted (input) and purposefully manipulated (process/technology) to create ‘products’ (output) that are of value in this same environment. To the extent that these products are valued, the market valuation exceeds the investment required to produce the product or service and subsequent production cycles (offering the same or more novel, valued products) continue to meet changing environmental requirements, the social system will (have a functional reason to) continue competing with others. The effectiveness and efficiency with which the transformation process is performed and the way in which it is done will therefore determine whether continued access to the physical (i.e. materials, finances and information) as well as psychological (i.e.

commitment and a sense of belonging) resources necessary for the social system to prosper and endure will be attained.

The important role of leadership is elevated (Fleishman, et al., 1991, p. 257) by assertions that system sustainability is at constant risk as the “subsystems arising from division of labour represent loosely coupled units whose actions must be integrated” and that “organisations are ultimately dependent on a set of unique and highly autonomous subsystems”, these comprising of “individual human beings whose involvement in an organisation may be conditioned by affiliative and esteem needs not directly relevant to concrete production” (Fleishman et al., 1991, p. 257). In other words, an organisation “has a structure and a life that makes it a dynamic organism... susceptible to the constantly fluctuating conditions of both its external and internal environments” (Olmstead, 2000, p. xiv). Thus, leaders are required to manage the complexity and conflict inherent to “environmental variation, subsystem differences and human diversity” (Fleishman et al., 1991, p. 257) via interaction or “exchange rules governing changes in perceptions and understanding” (Lichtenstein et al., 2006, p. 2) to affect “system wide emergent learnings, capabilities, innovation and adaptability” (Lichtenstein et al., 2006, p. 2) necessary for growth, adaptation and survival. It can consequently be argued that the mechanism through which leadership operates should be viewed more as an “*emergent event*” or “an outcome of relational interactions among agents” (Lichtenstein et al., 2006, p. 2) within a social system to enable competitiveness within the broader environment, rather than as isolated “specific acts”<sup>44</sup> performed by “individuals described as leaders” in a vacuum (Porter & McLaughlin, 2006) that fails to account for leader-team effectiveness interactions (Zaccaro, Heinen, & Shuffler, cited in Burke, Goodwin, & Salas, 2009) and leader-follower interactions.

Such a position increases the “relevance and accuracy of leadership theory” by allowing exploration into how “leadership outcomes are based on complex interactions” (Lichtenstein et al., 2006, p. 2) that occurs within social systems. If leadership transcends the individual (Lichtenstein et al., 2006) and is to be understood fundamentally as a system phenomenon (Hazy, 2006; Marion & Uhl-Bien, 2001) that is the product of interactions between leaders and different followers and (possibly other external) agents, it becomes important for leadership studies to extend beyond for example, the character or characteristic behaviours of effective supervisors (Seers, cited in Graen, 2004), to also confront the more critical topic of gauging leadership performance within a social system, which ultimately should be interpreted by way of the capability “to build and maintain a group that performs well relative to its competition” (Hogan & Kaiser, 2005, p. 172). This, in turn, points to the need for a (complexity acknowledging) leadership competency model, such as is the target of the current study, to be developed from a similar perspective in that *what the graduate leader does (i.e. level of proficiency with which key competencies are demonstrated) and consequently achieves within the social system (i.e. quality of competency results) should constitute enabling physical- and psychological conditions that augment the competency potential and competencies of the work unit*<sup>45</sup> as a whole.

Such an understanding would moreover be furthered if the above argument could be integrated with the argument presented under section 2.3 that a performance@learning competency model joins a performance@graduate development competency model and a (dynamic) performance@leadership competency model in which the learning competencies and learning competency potential latent variables coexist with the job competencies and job competency potential latent variables. Such integration would sequentially link the performance@leadership competency model in turn with a unit performance@work competency model (and an individual employee performance@work competency model). These two distinct, yet uniquely overlapping

---

<sup>44</sup> It is true however, that various leadership models have succeeded in providing very rich descriptions in this regard that will duly be considered in this study as well.

<sup>45</sup> This refers to an organisation as a whole or to a smaller team operating within a larger collective.

graduate and work unit competency models<sup>46</sup> can ultimately be viewed in terms of a larger nomological network in which the individual outcomes achieved by the graduate leader (i.e. competency results) simultaneously constitute the levels of malleable work unit competency potential (collective attitudes, psychological states, skills, knowledge, etc.) and the malleable work unit environment characteristics (via competency requirements and situational characteristics) so as to synergistically amplify the collective outcomes (i.e. competency results) eventually achieved by the work unit. This is why the emphasis of the unfolding literature study will be directed towards the investigation of the requisite leadership actions pertinent to four broad domains of the work unit system (the environment, work structure, conversion process and followers) that relate to the leader's tangible (strategy formulation, job design, functional coordination, resource deployment etc.) and intangible contributions (the influence exerted, knowledge imparted, etc.) spread across the entire system in providing a valid account of the graduate leader's potential role as an enabler of a work unit.

## 2.5.2 MANAGEMENT VERSUS LEADERSHIP

A second debate requiring elucidation relates to the extent to which the terms leadership and management are used in an interchangeable way throughout the literature, resulting in great confusion regarding the boundary between the knowledge domains associated with each respective practice (Toor & Ofori, 2008). This phenomenon can probably be ascribed to the fact that when studying leadership, researchers typically survey or observe people that are in management positions and therefore the assumption is often made that all managers<sup>47</sup> are leaders (Toor & Ofori, 2008). Despite this misnomer, some authors do propose that fundamental differences exist between the practices of leadership and management, especially when viewed from a more traditional perspective (see Table 2.4). In this regard, the science of management originated at the beginning of the twentieth century with the advent of the industrial revolution because of the need to ensure high levels of production and efficiency on the factory floor. Viewed from this more traditional perspective, management can aptly be described then as the continuous planning, organising, supervising, and controlling of resources in order to achieve organisational goals (Tatum & Nebecker, cited in Lowman, 2002). On the other hand, an evolutionary argument can explain how leadership and followership co-evolved from ancestral times in "humans, and quite possibly in other social species, because taking on such roles under the right conditions would have been adaptive" (Van Vugt, 2006, p. 356). Accordingly, Toor and Ofori's (2008, p. 64) description acknowledges the universality of leadership as a phenomenon more fundamental to societal growth,<sup>48</sup> which they describe as "a process that involves vision, motivation and actions of the leader that enables followers to achieve certain collective goals... The purpose of leadership is to provide direction and bring about change" (Toor & Ofori, 2008, p. 64). Table 2.4 contrasts leadership and management when viewed from a traditional perspective.

---

<sup>46</sup> The work unit competency model represents a 5-domain structural model that maps organisational unit characteristics onto behaviours that the unit needs to perform and in turn, maps these onto outcomes that the unit is held responsible to achieve. The model in addition maps situational/environmental characteristics (as main effects and in interaction with competency potential and competencies) on competencies and outcome variables and competency requirements on competencies.

<sup>47</sup> "Organisations provide their managers with legitimate authority to lead, but there is no assurance that they will be able to lead effectively" (Lunenburg, 2011, p. 3). However, "many managers perform the leadership role, and many leaders do manage" (Toor & Ofori, 2008, p. 62).

<sup>48</sup> Leaders represent revolutionary social forces that can bring about significant transformation in broader society (House & Baetz, cited in Staw, 1979) as well.

Table 2.4

*Descriptive comparisons between leadership and management*

CATEGORY	LEADERS	MANAGERS
Thinking Process	Focuses on people Looks outward	Focuses on things Looks inward
Goal Setting	Articulates a vision Creates the future Sees the forest	Executes plans Improves the present Sees the trees
Employee Relations	Empowers Colleagues Trusts & develops	Controls Subordinates Directs & coordinates
Operation	Does the right things Creates change Serves subordinates	Does things right Manages change Controls subordinates
Governance	Uses influence Uses conflict Acts decisively	Uses authority Avoids conflict Acts responsibly

Reprinted from *Leadership versus Management: A Key Distinction – At Least In Theory*, by Lunenburg, F.C., *International Journal of Management, Business, and Administration*, 14(1), p. 2. Copyright 2011 by Sciedio Press.

Thus, more traditional perspectives associate management with tasks such as budgeting, the drawing up of project plans, the development of incentives, and the setting of timetables, and leadership as a broader, more encompassing and revolutionary phenomenon associated with higher-level functions such as the setting of strategies, the alignment of people, and the creation of a vision (Northouse, 2007) – i.e. leaders were regarded as agents of change (Maccoby, 2000) and managers as the custodians of predictability who were expected to produce standards, consistency, and order (Kotter, 1990). Simonet and Tett (2013) refer to this view of the dichotomy between leaders and managers as the *bi-dimensional perspective* and assert that it is the position most often endorsed by leadership experts – i.e. management and leadership are distinct, yet often intersecting processes, both sets of roles which are necessary if organisations want to become internationally competitive (Sarros, 1992). If viewed in this way, leadership and management functions are complementary systems (Gokenbach, 2003) that represent two sides of the same coin (Bryman, 1992), with the former usually performed by senior management (executives) and the latter typically performed by “supervisory” personnel at different hierarchical levels.

There has recently been some movement in the field however, which is predicated on the belief that leadership and management are, or at least should be considered a blended function (Kotterman, 2006) or that the modern manager should first and foremost be an excellent leader (Tong & Arvey, 2015). This more recent view on management and leadership is referred to as the *unidimensional perspective* (Simonet & Tett, 2013) which treats both concepts interchangeably and as essentially involving the same functions – i.e. managers and leaders are embedded in (the same) organisational systems characterised by numerous, diverse demands... (and therefore) it is difficult to disentangle managers’ and leaders’ demands and actions” from each other (Simonet & Tett, 2013, p. 200). The latter view, in turn, is consistent with the *hierarchical perspective* (Simonet & Tett, 2013) according to which management is positioned as one element within the broader field of leadership (or in which leadership<sup>49</sup> is positioned as one element in the broader field of management). Regardless, proponents of both the *hierarchical* and the *unidimensional* perspectives concur that the actual differences between the functions involved in managing and leading are less pronounced than once thought, making it unnecessary to try to establish the fundamental distinctions between managers and leaders anymore, as both leaders and managers tend to employ a blend of overlapping behaviours (Yukl, 2002) which can be explained by using essentially the same set of models and processes. “The obvious implication here is that certain

<sup>49</sup> Lussier and Achua (2004) for example, propose the inverse argument that managers perform the functions of planning, controlling, organising, and *leading*.

aspects of the managerial role are held to be relevant to the description of leadership behaviour in organisational settings” (Fleishman et al., 1991, p. 253). Thus, consistent with the *hierarchical perspective*, the current study supports the notion that graduates will have a much higher probability of being successful if they can bring leadership<sup>50</sup> qualities to their managerial duties (Sineta, 1981) and vice versa. The current study therefore argues that the process of influencing the performance of organisational units by influencing the organisational competency potential, the environmental characteristics and the competency requirements requires competence on leadership competencies and on managerial competencies albeit, possibly, in different phases of the process. This viewpoint finds support in the work of Gardner (1990) who argues in favour of the rise of the *leader-manager* as well as from Hay and Hodgkinson (2006), who reason that even executives require capabilities in a combination of both leadership and management functions in order to be successful. Selznick (1957, p. 25) however, perhaps best summarised this stance in arguing the futility of trying to understand leadership in isolation from the broader organisation in which it operates:

... a theory of leadership will necessarily reflect the level of sophistication we have reached in the study of the organisation. We are dealing with an activity, with a function, with work done: we can make no more sense of it than is allowed by our understanding of the field within which that activity takes place.

Therefore, as graduates will inevitably be expected to lead others as part and parcel of performing their managerial duties as future heads of work units, the current study will also consider influential studies relating to managerial effectiveness in an attempt to enrich and position the graduate (leader) performance construct accordingly – i.e. as a blended function requiring capability in both management and leadership domains.

### 2.5.3 LEADERSHIP TRANSITIONS

A final debate concerning leadership effectiveness that has a bearing on the present study, relates to the notion that there exists a relatively predictable developmental pathway, or sets of qualitatively distinct functions at specific hierarchical levels in organisations that all aspiring executives must master as part of their journey in transitioning from individual contributor, to that of a caretaker of a team, and eventually to that of becoming the head of various teams comprising a total organisation. In this regard, Barlow (2006) highlights the shift in perspective required when for example, transitioning from a position requiring only individual contributions to becoming a team leader, or when moving from a team leader to a functional leader role. Ulrich, Smallwood and Sweetman (2008) reason similarly in describing four relatively stable stages of leadership development generic to all organisations, hinting at different domains (i.e. technical expertise, relationships, structures/processes, strategy) of operation through which an employee impacts the organisation as they progress (or transition) from being an individual contributor to eventually assuming core leadership responsibilities as the head of a collective. More recently, these transitions have been integrated in describing a pipeline (Charan, Drotter, & Noel, 2012) succession approach that provides a roadmap for the type of experiences that are necessary in developing critical competencies for six encroaching leadership passages leading to the highest leadership echelon (i.e. the leadership pipeline). These are: *managing others*, *managing other managers*, *managing functions/departments*, *leadership autonomy*, *holistic leadership* and *visionary leadership*. The assumption implicit in all these aforementioned arguments is that leadership requirements vary between different hierarchical levels at which leadership is enacted (Van Rooyen & Whittle, 2011), and more specifically, that leadership requirements gradually shift as individuals advance up the organisational hierarchy from managing the self and “managing things (i.e. being ‘experts’) to (being strategic and) leading people” (Tong & Arvey, 2015, p. 667) as the visionary head of a collective. See Table 2.5. Having positioned graduate

---

<sup>50</sup> According to Gardner (1990) it makes sense to model all managers around the typical leadership approaches that empower employees, value their contributions, and that encourages participation in decision-making.

development programmes as interventions targeting accelerated, generic leadership maturation, the critical questions that should be raised at this point is whether the requisite graduate competency (and possible malleable competency potential) sets do qualitatively differ between incremental leadership transitions, whether failing to master the requirements related to a particular transition is likely to hinder aspiring leaders when they reach future transition points (Barlow, 2006), and if substantial differences between transitions do indeed exist, which the current study is aiming to explicate.

Table 2.5

*Descriptive comparisons between progressive levels of leadership*

CATEGORY	FOCUS	PRIMARY TASK	ORIENTATION
Individual contributor	Impact through expertise	Job proficiency	Individual performance
Technical leader	Impact through relationships	Providing advice, guidance and assistance	Individual performance
Team leader	Impact through processes and structure	Leading a team	Unit performance
Strategic leader	Impact through strategy and long-term vision	Leading an organisation	Unit performance

Mumford, Campion, & Morgenson (2007) provide some perspective in this regard by arguing rather persuasively for the existence of a leadership strataplex – an abstract framework comprising cognitive, interpersonal, business and strategic requirements that is posited to encapsulate the full spectrum of competencies required across all leadership levels. More specifically, the argument is put forward that competencies in this typology have differing degrees of relevance appropriate to the level of leadership in operation. In this regard, the authors (Mumford et al., 2007) suggest that success in junior (i.e. impact through expertise) leadership positions is reliant on *cognitive competencies* such as oral communication, active listening, action learning and critical thinking. Cognitive competencies are regarded as the cornerstone of leadership competency requirements as the “majority of leadership activities draw heavily upon these primary skills” (Mumford et al., 2007, p. 157) – hence, cognitive competencies will be required in greater amounts and proficiency than the other three competency domains across all job levels. *Interpersonal competencies* such as negotiation, social judgement, and social perceptiveness on the other hand, become specifically important when leaders start operating at levels where they are required to impact the work unit through relationships with others. The authors (Mumford et al., 2007) regard this as the second most important competency set as all higher leadership levels will involve a significant amount of and increased proficiency in interpersonal interactions as well.

*Business competencies*, such as the management of material and human resources, are thought to be the third most frequently used competency set and becomes relevant at a stage when leaders progress to a position in which they take charge of a team. Finally, success in senior leadership positions (i.e. impact through strategy) is similarly predicated on the full array of ‘strataplex’ competencies, although an additional, less utilised competency set is required here relating to strategy formulation and deployment. “This is not to suggest that strategic skill requirements are unimportant, but simply that they are required in lesser amounts than the other three more fundamental leadership skill requirements” (Mumford et al., 2007, p. 158). Moreover, although jobs at higher organisational levels have additional leadership competency requirements (e.g. visioning, deployment of resources, etc.), they are also likely to require higher proficiency in the more fundamental cognitive and interpersonal competencies because the environments in which they operate are typically more complex, novel and ill-defined (Mumford & Connelly, 1991) and contain “organisational actors across all levels of the hierarchy, managers and non-managers alike,” requiring them to “absorb, process, make sense of (and), then disseminate a bewildering

flow of information in order to make decisions and solve problems” (Hodgkinson & Sparrow, 2006 p. 1). Thus, it is argued that leadership effectiveness is underpinned by a set of relatively consistent competency sets having varying degrees of relevance across and requiring increased proficiency at higher organisational levels, but also more importantly, that graduate development programmes targeting the appropriate competencies across cognitive, interpersonal, business, and strategic domains would constitute a valid and comprehensive developmental approach to buttress all future leadership transitions.

Leadership transitions however, are unlikely to leave the graduate ‘unaffected’. That is to say that transitioning experiences (early on) in the graduate’s career could serve as scaffolding for future success. This could be affected in two ways, the first of which relates to the initial stimulation of the dominant category of competencies in operation at a particular leadership level. Thus, in a technical leadership role requiring an individual to impact through relationships with people for example, developing leaders are given the opportunity to familiarise themselves with interpersonal competencies that would require further improvement to meet future, more demanding interpersonal leadership requirements. Similarly, in a very early leadership role where individuals are predominantly confronted with technical challenges, the hope is that they would develop their cognitive competencies to a sufficient level necessary for grasping the cognitive complexity they will encounter at a next leadership level. In the end, such concentrated, incremental growth paths provide for the systematic activation/stimulation of all requisite competency sets from the ground up that will require further development higher up along the leadership pathway.

Secondly, it is maintained that transitions provide opportunities for shaping competency potential variables that account for leadership effectiveness at higher levels as well. For example, the establishment of credibility and reputation (or self-efficacy) as a technical expert that would naturally flow from success in more junior leadership roles could positively impact proficiency in a future technical leadership role, in which the graduate will be expected to influence, guide and advise others. Similarly, the experience of impacting the business through relationships would naturally promote the development of social capital (e.g. connections) via interactions with various role-players, which could prove to be a valuable enabler for future leadership positions for which a support network might be crucial. A number of related examples is conceivable. This line of reasoning is also reflected in the direct feedback loop in Figure 2.8 from learning competencies at time  $i$  to learning and job competency potential at time  $i+1$ .

Maybe more importantly, however, it can then be argued that graduate development programmes will only be truly successful in starting to prepare graduates for the full leadership journey to the extent that they can be conceived, structured and delivered as an authentic simulation incorporating all of the above – see Figure 2.9. This implies: 1) such programmes to realistically fast-track the transition from individual contributor to that of team leader, providing genuine opportunities to develop competencies and competency potential as can be gleaned from being an individual contributor, (i.e. impacting through technical expertise) a technical leader, (i.e. impacting through relationships) and a team leader, (i.e. impacting through structures and processes); and 2) the simulation of a work unit characterised by real-life challenges and crucibles providing the rich context to mimic authentic work environment characteristics necessary for the graduate to learn and grow concomitantly.

The ‘product’ of the graduate development programme is thereby argued to be the delivery of a *well-equipped* team leader at middle management<sup>51</sup> level serving as readily available bench

---

<sup>51</sup> At the point where the graduate is unleashed into the organisation as a work unit leader, they will be expected to continue the leadership journey and grow to a strategic leadership level without the continued benefit of a simulated training environment. The development and refinement of the strategic competencies predominantly associated with strategic leadership, however, should already be initiated during the course of the graduate development programme to prepare the graduate for entry into strategic leadership positions.



strength for more senior leadership positions that: 1) has been exposed, albeit ‘artificially’, to the full range of transitions up to that point in developing competency potential in anticipation of the final leadership transition; 2) is fully proficient in the requisite cognitive, interpersonal, and business competencies consistent with that level of functioning; and 3) have had sufficient initial exposure to the strategic competencies requiring more refinement, practice and automatization when drafted into a strategic leadership position (i.e. the intended destination).

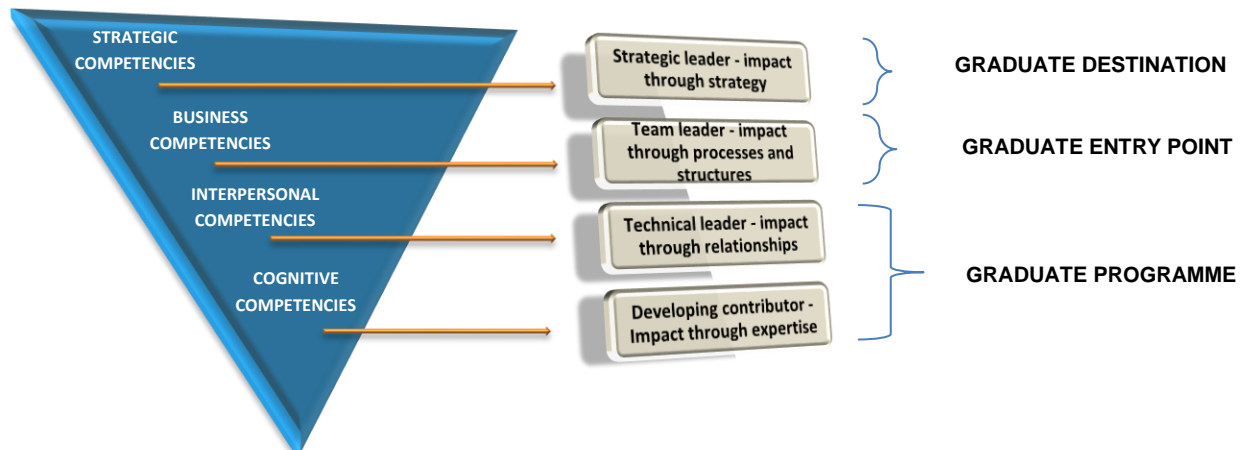

Figure 2.9. Integrated leadership strataplex and graduate leadership transitions schematics

Hence, the focus of the current study will remain grounded in the investigation of the longitudinal *graduate programme role competency model* in support of the explication of performance requirements related to the effective leading of people in a work unit, (i.e. strategic leader functioning in a social system) at the expense of exploring graduate performance from an individual contributor, ‘yet-to-transition’ perspective. Regardless, by focusing on the graduate programme role competency model and the full spectrum of outcomes to be achieved at a strategic level of functioning, it is not suggested that the competency requirements predominantly associated with earlier transitions will be neglected as legitimate grounds have been established for graduate programmes to target the activation and development of the entire leadership strataplex.

## 2.6 THE EXPLICATION OF THE GRADUATE PERFORMANCE CONSTRUCT

### 2.6.1 INTRODUCTION

With the longer-term aim of developing a competency model that is predicated on a complex nomological net that maps the structural relations between both latent competency variables and latent competency outcome variables of (strategic) work unit leaders, the study will now turn to an extensive and integrative literature review (Callahan, 2010) in an attempt to synthesise fundamental learnings on the topic and offer a (new) representative solution, or a credible and persuasive South African graduate leader performance *prototype*. The review will be undertaken by way of a careful study of the actual requirements<sup>52</sup> of the leadership role as conceptualised from a systems perspective as well as the country’s unique context, according to which a range of performance directives and behavioural requirements will be carefully organised into a meaningful and logical structure that is argued to be representative of a *generic, strategic partial leadership competency model* for South African graduates. Although it was earlier argued that the

<sup>52</sup> This approach is similar to the methodology employed in job analytic procedures that target the development of a job description or profile, consisting of job outcomes and competencies in summation of a position or job role.

latent competencies are logically predicated on the latent outcome variables, the analysis of the expectations set by the leadership role will not attempt to distil only the latent outcome requirements and then infer the latent competencies from the identified outcomes in a separate analysis. Rather, the outcome and behavioural demands imposed on the leadership role will be inferred as an integrated whole from an analysis of the structural and process prerequisites that exist with regards to the various subsystems that comprise the organisation to allow the organisation to successfully<sup>53</sup> combine and transform scarce input factors from the environment and output it as products and/or services valued by the environment.

Consistent with the principles of scientific classification (Morrison, 2000), the leadership outcomes and behaviours eventually explicated will be those consistently reported in various scholarly works over the years, will be labelled according to popular referencing, and selected on the basis of internal homogeneity, mutual exclusivity, and collective exhaustiveness. Despite following this careful categorisation process, it must nevertheless be acknowledged that the study will not attempt to revisit all of the more dated models published previously. However, it is believed that the taxonomies that were selected for inclusion in the review will successfully integrate past learnings on leadership/managerial effectiveness with current and more modern versions and adaptations thereof that are more applicable to contemporary settings.

## **2.6.2 LEADERSHIP OUTCOMES AND COMPETENCIES: A SYSTEMS PERSPECTIVE**

It was previously argued that social systems theory represents a powerful alternative for studying organisational behaviour and hence also a superior study framework from which to explicate leadership performance requirements in organisational settings. The utility of the paradigm stems from the manner in which it can be used to simulate the complexity underlying organisational functioning and by implication, therefore, also its potential to revitalise the leadership effectiveness research agenda by unravelling how leaders can expedite those processes in organisations through which interdependent actions among subsystems are combined into a collective venture (Lichtenstein et al., 2006).

More specifically, by employing a systems perspective, it is firstly more likely for researchers to build more plausible hypotheses regarding requisite leadership competencies and outcomes pertaining to different functional areas within an organisation by tracking the flow of 'throughput' originating and drawn from higher level suprasystems (i.e. the broader environment) sequentially progressing through a cyclical conversion process within the system as brought about by way of a combined effort from various internal subsystems (i.e. strategic, human or technical), right up to the point where valuable 'outputs' are exported back to the environment.<sup>54</sup> See Figure 2.10. Secondly, and perhaps more importantly, systems theory also shifts attention away from the study of individual parts to that of the integrated whole (Checkland, 1997; Jackson, 2003a; Weinberg, 2001) and thus permits a view of organisational functioning as a network of interrelated subsystems, analogous to an explanatory structural model depicting richly interrelated constructs, "where the individual properties of the single parts become indistinct" (Mele, Pels, & Polese, 2010, p. 126) and the relationships between the parts<sup>55</sup> themselves and the events and consequent outcomes they produce via system interactions emerge as the central topics of interest (Mele et al., 2010). The possibility of attaining

---

<sup>53</sup> Organisational success should in the final analysis be conceptualised in terms of the triple bottom line (Slaper & Hall, 2011).

<sup>54</sup> System components are not directly observable as is the case with the study of mechanical systems, but are rather more suitably described as qualitatively different areas of focal activity, where the actual structure of a (social) system is to be found in an interrelated set of behavioural events involving "loosely coupled" subsystems that gravitate around these focal areas and "whose actions must be integrated to ensure continued goal attainment" (Fleishman et al., 1991, p. 257). Therefore, the subsystems (and suprasystems) combine to form the theoretical 'performance at work framework' that can be used to study how employees as followers and leaders as managers collaborate in transforming inputs into products and/or services that are of value to the unit's internal and external environment.

<sup>55</sup> Ultimately, such a network when explicated, can serve to represent both a leader's enabling role in a work unit as well as the competency potential domain of a work unit competency model (Teece, Pisano, & Shuen, 1997).

such a holistic, rather than reductionist view of organisational functioning, is of particular relevance to and compatible with a competency-approach to the modelling of work unit performance (and therefore also leadership performance previously positioned as an overlapping construct) given the longer-term possibility of explicating a comprehensive explanatory structural model depicting how work unit competency potential (i.e. physical and psychological conditions that can be brought about and embedded by leaders) can structurally combine to alter the properties/capabilities of the organisational system as a whole (i.e. in terms of the leader's impact on collective system potential and behaviours as well as the consequent outcomes/output achieved). Therefore, the explication effort will attempt to utilise the "scientific skeleton" (Boulding, 1956, p. 208) of systems theory as a point of departure from which to "dredge leadership and systems theory literature to find a meeting point" (Ramosaj & Berisha, 2014, p. 59) in providing a basis for the unfolding literature study to build on.

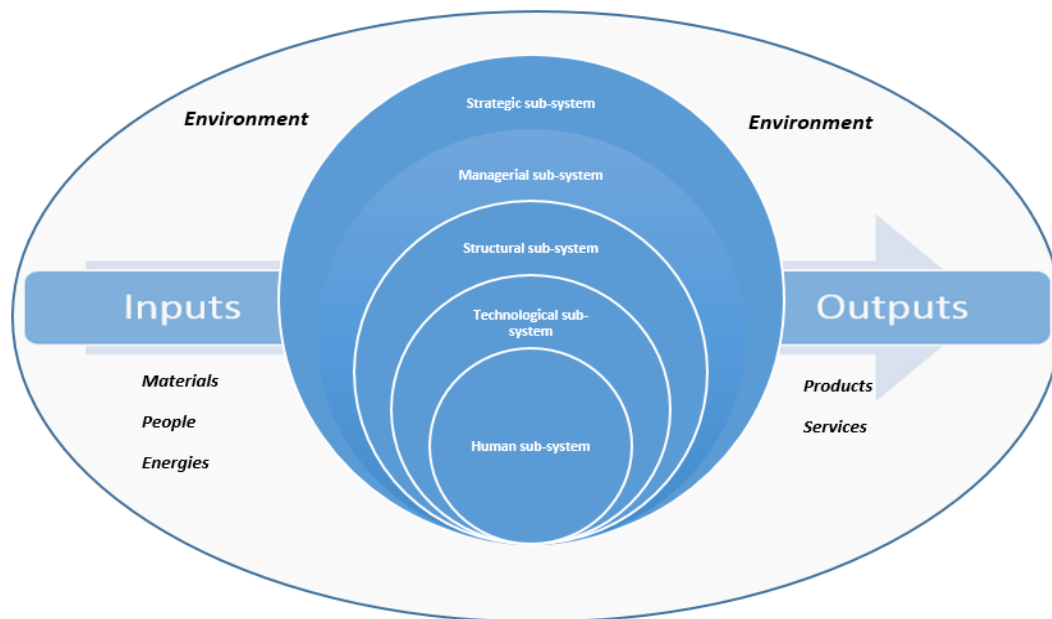

Figure 2.10. A simplified representation of the organisation as an open system

The five subsystems depicted above are those that are most often cited in management and organisational development literature (Katz & Khan, 1978; Morgan, 1997) and constitute such a 'skeleton framework' that is deemed to be representative of the generic and abstract domains of focal activity germane to all organisational systems. Thus, they provide fruitful avenues for further exploration in terms of how leaders<sup>56</sup> as boundary spanners (Cross, Erns, & Pasmore, 2013) at the helm (Spangenberg & Theron, 2013) of organisational decision-making have the potential to optimise each of these areas of focal activity respectively:

- The environment that the unit is in constant interaction with comprising of a number of *suprasystems* (i.e. forces, agents, competitors and other role-players functioning outside of the unit's boundaries), most of which may be largely beyond the control of the organisation (Mason, 2007);
- The *strategic subsystem* that regulates how the organisation understands and interacts with its environment;

<sup>56</sup> Leaders represent the managerial subsystem that is tasked with coordinating, adjusting, controlling and directing the other subsystems. The goal of the managerial subsystem is to improve the compatibility between system components (*consonance*) as well as the harmonic interaction (*resonance*) between them (Katz & Khan, 1978). A leader's role is conceived as a boundary spanner here, performing various functions in and between subsystems as well as between the unit and its suprasystems.

- The *structural subsystem* constituting elements of organisational design such as span of control, decision-making rights and responsibilities;
- The *technological subsystem* representing the ‘throughput’ assembly line or work-flow (i.e. the means with which work is organised and carried out as part of the conversion process);
- The *human subsystem* that emerges through interactions among subsystems, the distinctive properties of which are consequences and conditions of the specific interrelationships and resultant interactions among subsystems (and suprasystems); and
- The *managerial subsystem* (i.e. management/leadership) that is tasked with coordinating, adjusting, controlling and directing the other subsystems.

These five subsystems influence the work unit’s harvesting of inputs from the environment, influences the work unit’s combination and transformation of these inputs into products and services that it anticipates will be valued by the market and influences the outputting of these to the environment.

### 2.6.2.1 THE STRATEGIC SUBSYSTEM

The work unit’s broader environment comprising various suprasystems constitutes one focal area of interest that can be dissected further in attempting to formulate hypotheses on leaders’ potential function in the unit’s *strategic subsystem*. The external environment consists of a number of powerful and relatively non-malleable contextual suprasystems that include but are not necessarily limited to the economic, political, legal, social and demographic landscapes, competing systems, the customer(s), board of directors, technology, the government, and the natural surroundings (Beeson & Davis, 2000; Capps & Hazen, 2002) that ultimately serve to either enable or inhibit organisational functioning (Styhre, 2002) by determining the supply, demand and qualitative nature of a wide array of input alternatives (competitor positioning, technology, customer needs, materials, budgets, etc.) that are available for system consumption and exploitation. Given the criticality of the unit’s exchanges with these relatively non-malleable environmental suprasystems, timeous and valid information on significant changes that occur in these that are relevant to the organisation is therefore required in conjunction with a penetrating understanding of the strengths and weaknesses of the leader’s own organisational unit. This emphasises the boundary role of leadership in linking organisational units to or protecting (Tushman, 1977) them from the broader environment (Katz & Khan, 1978); accordingly requiring managers to be attuned to unfolding events outside (Ancona & Caldwell, 1992) and inside the system through the key leadership function of environmental scanning (Conger & Kanungo, 1992; Roby, cited in Bass & Petruccio, 1961; Theron & Spangenberg, 2005), a competency that Conger & Kanungo (1998, p. 121) describe as “heightened sensitivity to environmental opportunities and constraints, and followers’ abilities” and needs.

Perhaps the most important leadership application flowing from environmental scanning is the use of analytics extracted from the environment (Ramosaj & Berisha, 2014) and from the system itself<sup>57</sup> (i.e. follower aspirations, strengths, weaknesses, etc.), and the subsequent integration thereof in creating a viable and competitive future market position for the unit (Mele et al., 2010). Such a market position is predicated firstly on the creation of a longer-term vision, or a highly attractive and exciting proposition of what the unit can become that followers come to internalise and accept as their own personally valued ambition (Kouzes & Posner, 2002) because it “removes sources of discontent” and fulfils their hopes and aspirations (Conger & Kanungo, 1988). Thus, leaders are required to “gaze across the horizon of time, imagining the attractive opportunities

---

<sup>57</sup> In this regard, Howell and Avolio (1992) contend that leaders use the understanding of follower aspirations to augment their vision for the unit, while Ulrich et al. (2008) maintain that an understanding (and the consequent development) of current organisational capabilities is a key step in the creation of future market value.

that are in store when they and their constituents arrive at a distant destination” (Kouzes & Posner, 2010, p. 17) while at the same time, identifying the “blue ocean” entrepreneurial opportunities to exploit along the way in turning a substantial profit for the unit. The mere articulation of such an inspiring and aspirational vision and the garnering of follower support for and commitment to this cause, however, is unlikely to automatically provide clear guidance for the collective as to how specifically the valued end-state will be achieved. This is why many authors (e.g. Swanson & Torraco, 1995; Theron & Spangenberg, 2005) have suggested business strategy formulation as a qualitatively distinct, yet complimentary function flowing from environmental scanning and visioning that leaders can employ in further optimising the unit’s *strategic subsystem*. That is to say that followers are sometimes dependent on more concrete, operational guidelines that maps a clear path for achieving the vision which typically takes the form of a comprehensive business plan that is underpinned by explicit goals, targets and timelines. An effective strategy therefore links the unit’s vision with more concrete objectives (Desai, 2000), and ultimately serves to explicitly communicate the unit’s strategic intent to all stakeholders (Fraser & Stupak, 2002).

Moreover, a well-reasoned, shrewdly devised strategy and business case can also add additional value for the unit when trying to broker financial resources from the external environment for the cause as “the financial community and capital markets have to believe in the strategy if they are to support it” (Ulrich et al., 2008, p. 39) and to subsequently authorise capital flow or investments that are frequently necessary to sustain it. This is why leaders often engage other role-players from outside the organisation who could influence the future<sup>58</sup> of the firm such as important community members, activists, thought leaders and experts in (other) industries (Ulrich et al., 2008) to clarify their needs or concerns and get their input in developing a powerful and comprehensive societally integrated, pro-environmental and winning strategy that allows the unit to “occupy a strategic position that no one else can touch” (Ulrich et al., 2008, p. 26). This points to the need for the creation of a wide network of contacts that can be developed through community immersion in order to accumulate the social capital<sup>59</sup> necessary for the incorporation of diverse perspectives into unit (strategic) planning and consequent implementation and evaluation efforts (Driscoll & Goldring, cited in Firestone & Riehl, 2005; Griffiths, 2000). At the centre of it all, ultimately, should still be the recognition of customer needs in the shaping of such strategies (Ulrich et al., 2008, p. 39) as by “identifying key customers, learning their buying criteria, and involving them in building an organisation to serve them, companies are able to move beyond servicing to anticipating and partnering with key customers”.

While it is perhaps easier for individuals in senior management positions and central to their role, to create unit vision and mobilise strategic direction, some authors have debunked the popular belief that leadership is only reserved for a select few (Kouzes & Posner, 2002; Veldsman, 2002). There is an “increasing need for more leadership at all levels in the organisation” (Toor & Ofori, 2008, p. 68) and leadership can also be performed by people who are not in senior management or supervisory positions – i.e. the ‘informal leader’. In this regard, Wall and Wall (1995) and Charan (2008) have suggested that the responsibility for making incremental improvements that positively impact the business should be pushed down<sup>60</sup> to all levels in the organisation. Strategy, they argue (Charan, 2008; Wall & Wall, 1995) should be the business of all employees and

---

<sup>58</sup> Ulrich et al., (2008) argue that corporate social responsibility practices, social philanthropy and environmental sustainability initiatives are all important and in support of modern day organisational strategy and that leaders should blend these considerations with their more pragmatic plans for making profit as customers are increasingly starting to discriminate against those that fail to meet the criteria of acceptable and ethical business practices (Naidoo, 2002; Simms, 2003).

<sup>59</sup> However, if the “volume of social capital possessed by a given agent thus depends on the size of the network of connections he can effectively mobilise” (Bourdieu, cited in Richardson, 1986, p. 249), it stands to reason that the formation of contacts and connections within the unit itself represents a further source of competitive advantage.

<sup>60</sup> If it is accepted that not all labour inputs are equal and that the quality of employees as the carriers of labour can be improved by investing in them, then such practices can be considered crucial in building the human capital of the work unit. The employee experience and competencies gained and developed through such involvement ultimately have economic value for the business and also for the economy as a whole.

'spontaneous' leadership (i.e. front-line strategists) should be encouraged within all teams, departments, or functions in acknowledging, utilising and developing the collective wisdom and innovative capabilities of all employees. Pushing down such accountability would not only amplify employees' feelings of affiliation with and psychological ownership of a company, but could also increase awareness of the interplay between organisational success and individual contributions (Dyczkowska & Dyczkowski, 2015). Thus, consistent with the principles of Business Process Reengineering, (BPR) Total Quality Management, (TQM) and Lean Manufacturing (i.e. lean leaders) that stand in pursuit of continuous adaptation in competitive environments through process improvements that result from increased accountability that are pushed down to the workforce, it is argued that during everyday work-life when dealing with customers, colleagues, suppliers, or a myriad of other stakeholders, anyone can, and indeed should be held accountable to influence the quality of the strategic foresight of the organisation, even if only on a micro scale. In this way, competitive advantage results from a series of interconnected actions taken by leaders at different organisational levels in shaping organisational strategy. Wall and Wall (1995, p. 9) touch on the potential advantages of unlocking human capital as follows:

What we need are leaders throughout the organisation who are adept strategic thinkers, that is, people who understand the connection between their daily actions and the business's strategy, and who have the drive and skills to get their ideas heard and implemented.

The citation taken from Wall and Wall (1995) read in conjunction with the leadership transition argument presented in section 2.4.3 raises an important qualification. Organisations comprise of a large number of interlocking and encapsulated organisational units. Leaders on the strategic level are ultimately responsible for *environmental scanning*, the development of a compelling *organisational vision* on how the future organisation, its market offerings and market position differ from the status quo and a broad *strategy* on how the organisation intends bringing the vision to life. Pushing the responsibility for making incremental improvements that positively impact on the business down to all (leader) levels in the organisation should occur within the overarching organisational vision and strategy. To ensure that that is indeed the case requires the clear articulation of the vision and exciting the hearts and minds of all levels in the organisation to commit to the vision and to raise the organisational self-efficacy that the vision is attainable. By giving meaning to employees in this way, the leader aligns the motive states of members and other lower-level leaders with the purpose of the organisation as a whole (House & Shamir, cited in Ayman & Chemers, 1993), increasing the likelihood that followers become "psychologically intertwined with the group's fate" (Mael & Ashforth, 1995, p. 310). The creation of such meaning however, is not only brought about by way of an effective and aspirational business vision and strategy, but can be expedited and reinforced through a "unique value system" (Steiner, 1971, p. 121-122) to guide the decision-making and behaviours of employees towards this end. Derived in part from the business's strategy as well as the leader's personal character and preferences, this articulated and modelled set of values and beliefs (Robbins & Sanghi, 2007) ultimately comes to represent the *culture* of the organisation, informing "the patterns of basic assumptions" (Schein, 1985, p. 9) held about what group membership entails to ultimately shape and sustain leader-sanctioned work behaviours and conduct throughout the business. Hence, culture can be conceived of as an abstract value scheme<sup>61</sup> of a leader's distinctive character (Brown, 1995) as expressed in communication and behaviour, indicative of the overarching philosophy (views on morality, employee potential, supervisory approach, etc.) that permeates and is reinforced in the workplace, the setting in which employees are expected to operate in and commit themselves to. Linstead and Grafton-Small's (1992, p. 333)

---

<sup>61</sup> Leaders can shape the work environment through such schemes and culture can consequently be interpreted in terms of a competency requirement component of a work unit competency model.

conceptualisation of organisational culture perhaps best captures the essence of the leader's role from this point of view:

Culture (is) devised by management and transmitted, marketed, sold or imposed on the rest of the organisation... the rites, rituals, stories, and values which are offered to organisational members as part of the seductive process of achieving membership and gaining commitment.

Although strategy and organisational culture are intertwined (Spangenberg & Theron, 2013) and the resultant effectiveness of the chosen approach to both is to a degree dependent on contextual factors in the internal and external environment (Bate, 1994) as well as the leader's personal style, a number of authors have recently suggested that a focus on certain key values may have universal application as well as result in a number of important distal system benefits. For example, because a change in attitude has occurred in the last 25 years regarding the relationships between companies and society, and more specifically a shift from the companies' strictly economical responsibility to that of a social one, authors like Militaru and Zafir (2012) have called for the integration of ethical principles into every responsible company's organisational culture. Spangenberg and Theron (2013) have likewise championed the importance of ethical organisational cultures, although their plea originates within the context of the 2008–2012 American and European sub-prime mortgage financial disaster that culminated into an international recession at the time.

In addition to being the "right way" to do business, ultimately ethical (and green<sup>62</sup>) practices are believed to positively influence company image and reputation, which in turn, can impact long-term firm economic performance through the preservation and strengthening of strategic relationships<sup>63</sup> in the environment (Militaru & Zafir, 2012). Other values that have been linked to strong organisational cultures and that are believed to promote a number of valuable individual (i.e. psychological wellness, empowerment and safety) as well as system (i.e. a learning environment, innovativeness, performance improvement through goal-setting, monitoring and feedback) distal outcomes include trust and transparency (Bachmann & Zaheer, 2006), tolerance for mistakes, and creativity in product quality and customer service (Spangenberg & Theron, 2013), a sense of community (Pillai & Meindl, 1998) caring/support, (Seth, Sisodia, & Wolfe, 2007), fair treatment (Senge, 2006), and an achievement orientation (Xenikou & Simosi, 2006). As culture ultimately does not immediately originate from and become entrenched in "an object or system" (McGuire & Rhodes, 2009, p. 20) but only becomes engrained in such artefacts and in the minds of senior managers, supervisors and employees (Hogan & Kaiser, 2005) through persistent and consistent leadership behaviours and decisions over time, the manner in which a leader models, stands up for, participates in and puts himself on the line for certain values in various management applications (Schein, 1992) represents the most powerful primary mechanism for developing and transmitting culture. Hence, if "it is assumed that the personal values a leader holds will influence corporate beliefs, behaviour and decisions" (McCann & Holt, 2009, p. 211), it can be argued that the values of a high-performance culture can be nurtured and reinforced by leaders who consistently demonstrate green behaviours (i.e. a concern for the environment), encourage and welcome diversity, behave ethically and with integrity, humbly pursue self-development and continuous learning/improvement, has a tolerance for mistakes in service of learning/product quality, and treats others with fairness, respect and personal empathy as part of their daily managerial roles in the unit.

---

<sup>62</sup> The increasing importance of environmental sustainability have prompted researchers to include "green practices" (e.g. lean practices, carbon footprint reduction and eco-efficiency improvements) as an important consideration in the evaluation of organisational performance.

<sup>63</sup> For example, a company that is recognised for its ethical behaviour is more likely to be able to maintain their relationships with customers, government agencies and private partners. Research also suggests that individuals are more attracted to and prefer to work for ethical organisations (Coldwell, Billsberry, van Meurs & Marsh, 2008; Jose & Thibodeaux, 1999).

A further leadership application that flows from environmental scanning and that was already hinted at previously, relates to the procurement of external resources that are vital to unit functioning. An organisational unit was conceptualised previously as an open system that operates within a complex broader environment and that is in direct competition with other systems, and consequently, it can be argued that unit effectiveness in part will relate to its “ability... to exploit its environment (and outperform the competition) in the acquisition of scarce and valued resources” (Seashore & Yuchtman 1967, p. 898). From a systems perspective therefore, leaders as the central protagonists that are ultimately charged with the unit’s collective strategic environmental interactions during which exchanges are made that are “vital for the organisation’s survival and success” (Amagoh, 2008, p. 2) can be tasked with locating and ensuring the inflow of vital and scarce energies and information from the external environment to renew and differentiate the system (Katz & Khan, 1978) from others and breathe life into its *technological, human, and structural subsystems*. Over and above the acquisition of financial resources as previously mentioned, however, this could also involve the acquisition of key people (e.g. talent, knowledge and experience) and key materials (e.g. equipment, tools, infrastructure, storage space and supplies) as input to pursue and achieve the valued end-state. Thus, similar to negotiating follower buy-in to the unit’s vision and strategy, leaders can be held responsible for attracting and securing investors and talented employees by employing the same type of behaviours in brokering the resources required to implement the business/performance plan from various role-players that are located in the external environment (Mintzberg, 1973). This could even, under circumstances, necessitate the employment of a partnership approach (e.g. strategic alliances, mergers, parent-subsidiaries, cost-sharing partnerships and funding alliances) with other systems in situations where it is impossible to secure exclusive rights over or to broker unfettered access to scarce resources. Indeed, given the fact that “head-to-head competition among independent firms is giving way to networks of alliances that compete for business on a global basis” (Daft, 2008, p. 74), a unit’s ability to successfully partner<sup>64</sup> with others is likely to become increasingly relevant in sustaining a viable market position for the future. The importance of proficiency in the competency of environmental scanning is also once again alluded to here in that a certain level of vigilance (Roby, cited in Bass & Petruccio, 1961) is required in order to be able to timeously identify those critical partners with whom to form and maintain beneficial networks (Costley & Howell, 2006) where and when such opportunities present themselves. High proficiency in environmental scanning (with emphasis on changes external to the unit) is likewise important in being able to identify the veiled market patterns from which to subsequently extract the underlying trends that provide the opportunities with which anticipated reciprocal relationships can be brokered upon in the first place.

In addition to visioning, strategy creation and the attraction and acquisition of scarce resources, Mintzberg (1973) identifies a further possible leadership application that can flow from successful environmental scanning which he refers to as an *information processing* function, according to which managers can serve the collective by buffering the unit from environmental uncertainty and influences. Here the argument holds that leaders are uniquely positioned so as to aid the *strategic subsystem’s* knowledge diffusion (Tushman & Scanlan, 1981) capability because through their position at the helm of the organisation, they have the means and opportunities to collect pertinent and valued information (e.g. through board meetings and governmental interactions), are connected to know how and where to attain specific information

---

<sup>64</sup> The argument, that a unit is largely a self-contained identity that simply ‘exploits’ its environment and forms alliances to acquire scarce resources without any concern for the socio-economic and community issues of the larger system in which it operates have recently been challenged along with traditional views on capitalism that confine a unit’s role in the larger community as a contributor simply through the provision of employment, wages, investments, taxes (Porter & Kramer, 2011) social philanthropy and corporate social responsibility (Porter & Kramer, 2011) practices. The growing acknowledgement of the symbiotic relationship that exists between a unit and its environment and the fallacy of “presumed trade-offs between economic efficiency and social progress (that) have been institutionalised in decades of policy choices (Porter & Kramer, 2011, p. 48) have prompted a call for leaders to bring companies and their societies back together on a narrower, interlinked path towards collective progress – i.e. a *shared value approach*.



(such as by speaking with other industry experts, government officials and suppliers), and are informed as to who needs to be made aware of the information (e.g. followers inside the unit directly influenced by this). The collection of strategic information, data and knowledge and the subsequent masterful<sup>65</sup> dissemination thereof downwards throughout the organisation then helps to ensure that constituents are kept updated on significant changes that occur in the unit's suprasystems relevant to their areas of responsibility without being overwhelmed by information overload or suffering from disruptions associated with attempts to uncover such complex patterns, trends or insights by themselves.

Boundary spanners operating on the unit's periphery, however, must not only be able to absorb and effectively utilise and disseminate knowledge from the environment surrounding them, but are also required to transmit information back to the environment in representing and legitimising the unit's interests (Tushman, 1977) and upholding and safeguarding stakeholder relations there. This type of *spokesperson role* (Mintzberg, 1973) that managers utilise in influencing, persuading and lobbying some of the more malleable external suprasystems (e.g. government policy and consumer perceptions) towards the unit's cause tasks leaders, who possesses an umbrella understanding of unit operations, with representing the collective entity by way of *unconventional*<sup>66</sup> interactions with key stakeholders and transmitting important news, breakthroughs and announcements via press conferences, media gatherings, notices, board reports (Eys, Loughhead, & Hardy, 2007) or financial results. Leaders that demonstrate high proficiency on this competency engender respect and trust through these cross-boundary exchanges and build passion and commitment to the cause by captivating the hearts and minds of audiences in a similar manner to that in which followers inside the unit are enlisted.

The extent to which the leader can transmit accurate information about unit functioning to external constituents is reliant on their knowledge of how the organisation is performing which emphasises the importance of the internal component of environmental scanning and at the same time, broaches the need for the inclusion of a requisite *monitoring function* in strategic leaders' competency repertoires as well. The importance of such a *monitor* leadership role in the unit's *strategic subsystem*, however, is promoted beyond a mere reporting function by systems theory that positions feedback mechanisms as arguably the most essential precondition for the survival of an open system. In this regard, feedback is crucial in understanding how a work unit can maintain a state of *dynamic equilibrium*; self-regulation aimed at adjustment to "move the system on a dynamic path." (Cornell & Nwoka, 2015, p. 4). "The feedback principle has to do with information input, which is a special kind of energetic importation, a kind of signal to the system about... the functioning of the system in relation to its environment." (Damachi, 1978, p. 36). However, "unlike closed systems, open systems are not interested in returning... back to some predetermined state... open systems seek continuous improvement and not just stability" (Cornell & Nwoka, 2015, p. 4). Thus, it is through feeding back information to a central structure (i.e. the *managerial subsystem* fulfilling a *monitor role*) which acts on such information, that a work unit can "correct for its own malfunctioning" (van Uden, 2004 p. 78) to maintain its competitiveness and continued relevance (Katz & Khan, 1978) in the environment. In discussing the principles and design of feedback systems, Åström and Murray (2008) mention two types of feedback mechanisms that are relevant to the unit's *strategic subsystem* that can enable open systems to self-regulate and adapt, the responsibility for the implementation of both which can

---

<sup>65</sup> According to stratified systems theory (Jaques, 1996, 1970), strategic leaders are thought to operate at higher levels of cognitive complexity, are more comfortable (Harvey, Hunt, & Schroeder, 1961) with ambiguity, perceive more differences in the environment and thus are in a better position to interpret environmental indicators on behalf of the unit. Lower level employees in contrast, are typically immersed within more functional roles in the unit and are therefore likely to be less effective in performing similar environmental scanning tasks (Yukl, 2002).

<sup>66</sup> According to Charismatic leadership theory (Conger & Kanungo, 1987), unusual, novel and 'outside-of-the-box' leader behaviours draws people to the cause and captures their attention. The effect that this type of behaviour can have on followers is enhanced when leaders take personal risks and make self-sacrifices in demonstrating commitment to the unit and its cause (Conger & Kanungo, 1998).

be added to the long list of leadership performance requirements in modern organisations. Negative feedback is reactive in nature and represents an *ex-post facto* identification of errors or shortcomings driving corrective actions, enabling the system to correct its deviations from course (Katz & Khan, 1978). In pulling through the open systems analogy to an organisational context, negative feedback mechanisms are tantamount to more traditional performance monitoring systems that despite their usefulness, had an over-reliance on financial outcome measures (Kaplan, & Norton, 1992) by only allowing for reporting on (historical) organisational performance/profit outcomes retrospectively. More than providing limited, retrospective information, the exclusive reliance on lag indicators might also result in a further pathology that is associated with the entrenchment of counterproductive unit behavioural patterns regarding the monitoring/planning of performance as Shafritz, Ott, and Jang (2015, p. 353) aptly explain:

Systems can react only to those information signals to which they are attuned. The general term for the selective mechanisms of a system by which incoming materials are rejected or accepted and translated for the structure is coding. Through the coding process the blooming, buzzing confusion of the world is simplified into a few meaningful and basic categories for a given system. The nature of the functions performed by the system determines its coding mechanisms, which in turn perpetuate this type of functioning.

Feed forward controls, on the other hand, are proactive in nature and constitute mechanisms that allow the system to anticipate exigencies and take corrective actions before system disturbances can occur. Examples of more progressive and contemporary feed forward controls that need to be “coded” into modern organisational contexts can be found in the work of Kaplan and Norton (1992), who addressed traditional performance measurement shortcomings by developing the *Balanced Scorecard* approach to performance strategy generation and measurement. Conceived as a dashboard that management teams can use in quickly summarising an organisation’s health through a focus on five interrelated *performance perspectives*, the authors elevated other previously implicit, yet often ignored components of organisational performance to their appropriate level of significance as part of an overarching process through which organisations can plan, communicate, implement, and measure their performance. These perspectives represent an organisation’s tangible and intangible assets, such as *finances*, (i.e. to be successful, what should we look like to our shareholders?) *customers*, (i.e. to be successful, what should we look like to our customers?) *internal processes*, (i.e. to be successful, what internal processes should we excel at?), *growth and innovation* (i.e. to be successful, what type of culture and competencies do we require?) and *shared value*<sup>67</sup> (i.e. to remain successful, what should the community in which we operate look like?) – that collectively provide for a more accurate, encompassing framework for understanding<sup>68</sup> and improving work unit performance. (See Figure 2.11).

---

<sup>67</sup> The shared value perspective was not included in Kaplan and Norton’s (1992) original theoretical framework.

<sup>68</sup> The Scorecard approach adds value in that it gives equal consideration to short- and long-term performance requirements. The performance measures included furthermore pertain to both a recording of the results achieved (i.e. lag indicators) as well as the drivers thereof, (i.e. lead indicators) thereby providing for an intricate and explicit ‘hypothesis’ of cause and effect relationships between various objectives that can be tested/validated, and used to more easily cascade a particular business strategy. This is achieved through the logic implied in the Scorecard architecture, which holds that human capital (i.e. the right people must be employed, trained and engaged) is the enabling factor in operational excellence in terms of the value chain (i.e. length of production cycles and operational costs) that an excellent conversion process will inevitably result in improved products and services, which in turn, will lead to improved customer satisfaction (i.e. loyalty and increased market share) and finally, increased profit (share price and year-on-year earnings). The success of this logic is to be interpreted within the shared value that exists in the overall community in which the unit operates that ultimately defines the extent to which innovation, financial results, internal process and customer service excellence can be realised.

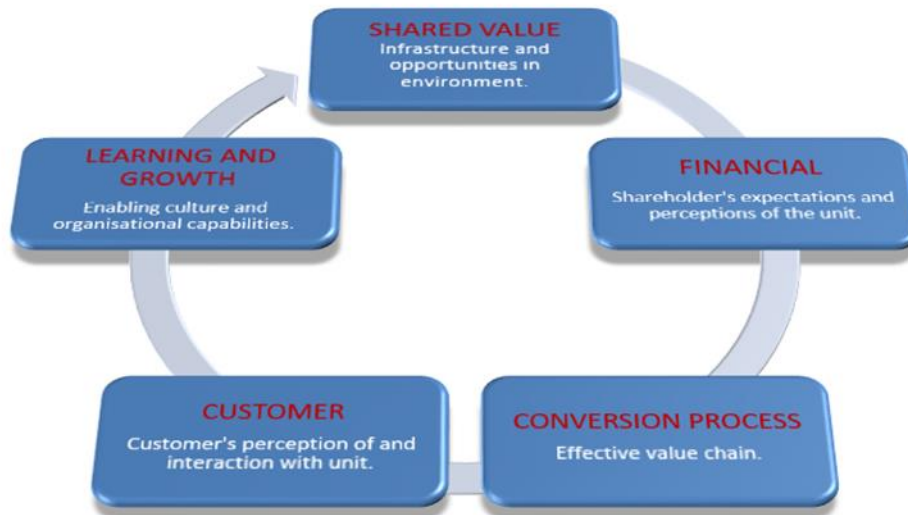

*Figure 2.11.* The Balanced Scorecard approach to strategic performance management

While it is not the immediate priority of the current study to investigate the specific measures and objectives utilised in different company scorecards, nor the more intricate details associated with their creation and implementation, the critical point to appreciate at this stage is that a strategic performance monitoring system is crucial to the long-term survival of a work unit. Leadership performance should be evaluated, in part, also by the success with which they can implement such systems as well as the value/utility of the information that such systems come to extract. In light of the foregoing arguments, leaders then can be held responsible for extracting environmental analytics and for creating psychological ownership, an effective strategy and ensuring that resources are secured and available<sup>69</sup> for the execution of the strategy in the unit's strategic subsystem. Table 2.6 below provides a detailed summary of the generic leadership competencies that were harvested from the hypothesised leadership responsibilities in support of the achievement of these competency results in the unit's strategic subsystem.

---

<sup>69</sup> These represent latent competency results variables of the performance@leadership competency model that 'double' as competency potential variables in a sequentially linked unit performance@work competency model. These will be discussed in more detail at the end of this chapter.

Table 2.6

*Leadership competencies extracted from the strategic subsystem*

COMPETENCY	COMPETENCY DESCRIPTION	COMPETENCY	COMPETENCY DESCRIPTION
External scanning	<i>Systematically surveys the external world to identify ongoing opportunities and threats relevant to unit survival and performance.</i>	Develops an inspiring vision	<i>Develops an inspiring value proposition of what the unit stands for and where it is going to that excites and attracts followers to the cause because it appeals to the human condition for satisfying a higher meaning in and purpose to their lives.</i>
Internal scanning	<i>Regularly liaises with employees to learn about their hopes and aspirations, analyses their talent capabilities, and collects information about the conditions in and capabilities of the unit.</i>	Builds commitment to the cause.	<i>Shares the unit's cause with followers with energy and passion backed up by resolute conviction and reinforces these messages/vision of the future throughout to re-invigorate followers towards the cause.</i>
Displaying foresight	<i>Anticipates trends and patterns from a somewhat chaotic environment that may impact the industry in the future as well as the possible political, economic, social and ethical repercussions thereof.</i>	Unconventional behaviours	<i>Performs symbolic and self-sacrificing acts in public and engages in novel, unconventional and 'out of the box' behaviours to draw attention to the unit's cause.</i>
Strategic monitoring	<i>Implements and monitors strategic lead- and lag performance indicators in the unit relating to internal process functioning, customer and shareholder satisfaction tracking, and unit innovation and shared value capability.</i>	Attracts followers to the cause	<i>Excites and captures the hearts and minds of outsiders towards the unit's cause by expressing and marketing the unit's vision at formal or social gatherings or other mediums of communication with passion and credibility.</i>
Information diffusion	<i>Translates the implications of identified and pertinent environmental events/occurrences into easily digestible messages that are relayed to the unit members affected by this.</i>	Entrepreneurial flair	<i>Identifies entrepreneurial opportunities to exploit viable, profit generating niches for the unit.</i>
Creates business opportunities	<i>Engages and persuades other role-players in the environment to eliminate barriers to the success of unit business ventures on the basis of factual, eco-friendly and 'win-win' logic.</i>	Keeps in touch with constituency needs and concerns	<i>Identifies key customers/constituents and consults with them regularly to learn their changing buying criteria and/or needs/concerns to create long-term partnerships.</i>

Table 2.6

*Leadership competencies extracted from the strategic subsystem (continued)*

<b>COMPETENCY</b>	<b>COMPETENCY DESCRIPTION</b>	<b>COMPETENCY</b>	<b>COMPETENCY DESCRIPTION</b>
Conceptualises business strategy	<i>Devises powerful, societally integrated, winning strategies for exploiting identified niches and outperforming competing units.</i>	Builds a wide network of contacts	<i>Develops a network of personal, valued contacts inside and outside of the unit that provides support, feedback, insights and information.</i>
Drafts business cases	<i>Captures the unit's performance plan in the form of a practical, operational blueprint outlining the actions, processes and resources required to capitalise on an identified market niche.</i>	Cascades shared accountability	<i>Translates strategy into broad objectives, targets and priorities for followers who are given ownership thereof and the discretion to affect unit improvements in their areas of accountability.</i>
Explores strategic partnerships	<i>Suggests, forms and maintains partnerships with or between other units/agents in the environment in unlocking synergistic, sustainable economic and social community gains for the benefit of all that otherwise would have been lost.</i>	Brokers resources	<i>Negotiates the resources needed for the unit's strategy or for specific projects, ensuring that the required inputs, materials and equipment are available at the right time.</i>
Explores shared value	<i>Reaches out to improve, strengthen and protect the local supporting suppliers, other collaborators and the environment.</i>	Demonstrating green behaviours	<i>Shows concern for the environment, and environmental sustainability is put at the forefront of all decisions and actions.</i>
Displays self-improvement drive	<i>Humbly pursues self-improvement and encourages the same in others.</i>	Treating others with respect	<i>Actively listens to followers and engages them with courtesy and respect.</i>
Displays authentic intent	<i>Has positive and transparent intent with people by consistently operating from a base of integrity and ethical principles.</i>	Leverages diversity	<i>Encourages, appreciates and leverages diversity to improve unit performance.</i>
Application of merit	<i>Makes decisions about promotions, benefits, rewards and incentives from a base of transparent meritocracy.</i>	Displays tolerance for mistakes	<i>Has patience, understanding and is lenient towards slip-ups and errors that are made in service of learning.</i>
Staffing	<i>Recruits staff with the necessary competency sets and in sufficient numbers to effectively execute unit conversion process.</i>	Emphasises customer service	<i>Demonstrates commitment to service excellence, encourages others to listen and react to what customers want.</i>
Product/service innovation	<i>Conceives products/services and business opportunities in a way that is cognisant of and meets societal needs.</i>		

### 2.6.2.2 THE STRUCTURAL AND TECHNOLOGICAL SUBSYSTEMS

A compelling unit vision that the unit has committed itself to, an effective strategy to roll out the vision and a high-performance culture are necessary but insufficient to allow the organisational unit to successfully transact with its environment. That is to say that the conversion process implied by the vision and strategy cannot occur if the components of the work unit are not rationally connected (Luhmann, 1990) towards this shared purpose, regardless of what this might be, by the establishment and maintenance of a *structure* that both gives the system the form to fulfil its function in the environment (Nelson & Quick, 2011) – i.e. strategic fit<sup>70</sup> (Johnson, Scholes, & Whittington, 2008) as well as increases the likelihood that system-wide high-performance qualities will emerge – i.e. vertical fit<sup>71</sup> (Amagoh, 2008).

In addition to vision, strategy and culture, organisational structure is therefore a further extension of the manifestation of a leader's "meaning-making" and "sense-giving" activities to organisational members, providing the infrastructure for the development of a more comprehensive and effective group mental model that "encodes how the team ought to respond to the problem situation" (Zaccaro, Rittman, & Marks, 2001, p. 462). This *structural subsystem* is built, adapted and maintained by leaders (Mele et al., 2010) in their capacity as managers and constitutes a "relatively enduring allocation of work roles... creating a pattern of interrelated work activities" (Jackson & Morgan, 1982, p. 81) that imposes the leader's blueprint for the distribution of responsibility, authority and accountability throughout the system (Lewis, 2003). This formal configuration (Greenberg & Baron, 2008) of the hierarchical arrangement of duties and work to be done is typically enforced via job descriptions, rules and procedures, and graphically often by way of an organogram (Elsaid, Okasha, & Abdelghaly, 2013) depicting the various reporting relationships in the unit.

Therefore, organisational structure firstly serves as a foundation for the design of the unit's conversion process that is located within its *technological subsystem* and secondly, involves the purposeful arrangement of reporting and working relationships and thus formal interactions and communication channels (Greenberg & Baron, 2008) allowing for (functional) information flow<sup>72</sup> to occur, the effectiveness of which is a vital determinant of competitive firm behaviour (Bock, Zmud, Kim, & Lee, 2007). Conceived in this way, organisational structure can serve as one source through which leaders can shape both collective employee actions as well as impact the situational/contextual job characteristics (operating to influence the follower group's standing on a number of collective psychological states), both of which are believed to form part of an overarching mechanism that regulates work unit performance. Clemmer's (2003, p. 16) view on the potential debilitating effects of organisational structure provides a supportive narrative in this regard:

Good performers, in a poorly designed structure, will take on the shape of the structure. Many organisations induce learned helplessness. People become victims of "the system". This often comes from a sense of having little or no control over their work processes, policies and procedures, technology, support systems and the like. These feelings are amplified by a performance management system that arbitrarily punishes people for behaving like the system, structure or processes they have been forced into.

---

<sup>70</sup> This study interprets strategic or horizontal fit, a state where the internal operations of the organisation are optimally configured so as to achieve a given strategy, as one form of work unit competency potential.

<sup>71</sup> Vertical fit is regarded as another form of work unit competency potential and refers to the coherence with which different subsystems are aligned with each other.

<sup>72</sup> Described as a system binder (Almaney, 1974) or the lifeblood of any organisation (Rogers & Rogers, 1976), this study interprets information flow as a further work unit competency potential variable that that serves multiple important functions (Jivan & Zarandi, 2012) such as the cultivation of subsystem coordination (Myers & Myers, 1982), creating and influencing the development of culture (Modaff, DeWine, & Butler, 2008), and the basis for meaningful decision-making (Bensghir, 2006).

Accordingly, as any given structural alignment has limits in terms of its capacity to affect constructive synergies between different subsystem components, it is important that leaders can capitalise on structural configuration by designing a type of work scheme arrangement that adds more to the system than merely the performance benefits associated with alignment alone. To clarify the options at a leader's disposal towards this end, Robbins and DeCenzo (2008) suggest that structural configuration involves decisions concerning six key elements: work specialisation, departmentalisation, chain of command, span of control, centralisation and decentralisation, and formalisation. Zheng, Yang, and Mclean (2010) in turn favour a more parsimonious typology including the elements of formalisation, centralisation and control. The preferred typological detail notwithstanding, structural design elements can be thought of as highly interrelated in that they would tend to qualitatively gravitate together, albeit in different ways, as a result of a leader's choice of one of two broader, contrasting approaches that hold implicit clues as to their world-view regarding the determinants of human motivation (i.e. Theory X<sup>73</sup> and Theory Y). See Table 2.7 – and beliefs about what constitutes an effective management style.

Table 2.7

*The philosophical differences between Mcgegor's Theory X and Theory Y*

THEORY X ASSUMPTIONS: MECHANISTIC	THEORY Y ASSUMPTIONS: ORGANIC
People have an inherent dislike of work	People do not have an inherent dislike of work
People need to be coerced, controlled or directed	People can exercise self-control and –direction
People wishes to avoid responsibility	People learn to accept and seek responsibility
People have relatively little ambition	People have capacity for ingenuity and creativity
People want security above all	People's potentialities are only partly utilised

Reprinted from Douglas McGregor's Theory X and Y: Toward a Construct-valued measure, by Kopelman, R.E., Prottas, D.J., & Davis, A.L., 2005, *Journal of managerial Issues* XX (2), p. 255. Copyright 2005 by Pittsburg State University.

For example, an 'X structure'<sup>74</sup> would typically be characterised by high degrees of work specialisation/departmentalisation, as well as a greater chain of command, stricter supervision and top-down decision-making. Most *functional* organisational configurations and their variants (product, customer or divisional) embody these principles as inherited from previous management cadres, and can be interpreted as forms of 'X structures'<sup>75</sup> in that their structural configuration incorporates *different layers of management* that are employed as gatekeepers of employee action and decision-making as well as a *division of labour* that employs specialists in specific jobs underpinned by clearly demarcated role descriptions and standard operating procedures. Corresponding closely with these lines of hierarchical management authority, the official lines of communication within such organisations then typically follow a top-down approach instilling leaders and managers with a sense of power (Davenport, Eccles, & Prusak, 1992), serving as a linkage mechanism (Hagen, Aiken, & Marrett, 1971) to coordinate employee actions via messages about procedures and practices, job instructions, and the company goals, strategies and objectives (Canary, 2011). The activities of employees are 'programmed' in this way and departures from the plan become immediately obvious leaving little uncertainty as to the recipients of rewards and punishments (March & Simon, 1958; Thompson, 1967).

Thus, the logic<sup>76</sup> of such structures is predicated on a control mentality (that in turn is rooted in a rather negative set of people assumptions) that deploys higher skilled and more trusted

<sup>73</sup> Influenced by the work of Abraham Maslow as well as his experiences of being a manager and consultant, McGregor (1960) formulated his theory of contrasting and contradictory approaches to the management of people, which is outlined in Table 2.7.

<sup>74</sup> It is acknowledged that the concept of X and Y structures is relative, not absolute – an organisation's structure can never be completely representative of one or the other and most vary on a continuum between the two extremes.

<sup>75</sup> Some authors refer to these as mechanistic structures and Theory Y structures, as organic structures (Daft, 2008; Kirsch, Mitsihashi & Sine, 2006).

<sup>76</sup> This logic was inherited from the work of Frederick Taylor, whose *Scientific Management* approach championed the use of standard methods for performing each job and the planning of work on behalf of employees.

managers to direct employee behaviours and an efficiency agenda that is believed to improve productivity through the preservation of consistency (saving time by eliminating set-up or duplication costs associated with moving employees between different tasks, employees become highly proficient in stable, repetitive jobs associated with stable products and services) and specialised training agendas (it is more difficult, expensive and time-consuming to train, or recruit, employees on the complete portfolio of an organisation's operations, as opposed to familiarisation with just one component). Hence, the purpose of structure within this context is to institutionalise stability (Nadler & Tushman, 1980), and as a result, mechanistic configurations often yield more efficient operations (Ambrose & Cropanzano, 2000), faster, albeit possibly less effective and non-inclusive top-management decision-making, and more predictable performances from staff, particularly in less complex and more stable environments (Ambrose, & Cropanzano, 2000). Despite these potential advantages, mechanical structures have been subject to much criticism in recent times as these configurations can often lead to a breakdown in communication between functional departments or groups, slow project/change implementation time frames, and contribute to a degree of inflexibility (Lewis, 2003). Mechanical organisation structures also tend to have an ironical Pygmalion effect in that their employees tend to behave in a way that substantiates the people assumptions<sup>77</sup> implied by the design principles of the mechanistic organisation structure.

In stark contrast, a Theory Y structure is typically characterised by low degrees of specialisation and formalisation and consequently allows for more fluid employee work roles, a flatter hierarchy, and less prescriptive rules/specifications about the flow of information and the limits of employee contributions. This is achieved primarily by way of a liberated, multidisciplinary network arrangement of employees that are collectively responsible for the total value added to the throughput and that are given the discretion to make decisions and suggestions at the point where the work actually gets done and customer interactions and value-add frequently occur. Jobs are arranged and designed so that they are not perceived as “dehumanising or demeaning” and that human diseconomies do not arise from work specialisation and centralised decision-making, “but instead allow workers to use their full potential” (Daft, 2008, p. 43) through opportunities to meaningfully interact with and spontaneously impact their task environments. A subtle mindset shift actually occurs in that rules and regulations become replaced by information and advice (Burns & Stalker, 1961). Accordingly, the underlying control mechanism in this configuration shifts to that of *mutual adjustment* (Mintzberg, 1983) – a simple and efficient process of informal communication between operating employees (and perhaps a guiding team leader<sup>78</sup>) in the form of quick feedback cycles that rapidly generate, transmit and freely disperse new information into the system (Hagen, Aiken, & Marrett, 1971); upwards, downwards, and horizontally.

As is the case with more mechanistic structures, some form of downward communication will occur from supervisors or managers to employees on matters such as new project goals, priorities and possible challenges. Consistent with arguments previously aired regarding the delegation of responsibility to the organisation's front line, the framing and identification of problems, exceptions and suggestions for improvement constitute messages that could be directed from employees upwards, while information dispersed horizontally would typically facilitate interdepartmental (i.e. between team) problem-solving and coordination (Canary, 2011). As a result, these types of structures are more supportive of creativity (Rozman & Kovač, 2015),

---

<sup>77</sup> Moreover, bureaucratic-pyramidal values tend to elicit poor, superficial relationships between unit members that are not authentic and lead to a psychologically unsafe environment (Argyris, 1980).

<sup>78</sup> Ulrich et al., (2008) believe that it is the leader's responsibility to “assign top talent” to supervisory or middle-management leadership positions that serve as enthusiastic and energetic champions (i.e. surrogates) of the strategic leader's cause. This tasks leaders with firstly the selection of talented supervisors/managers that demonstrate behaviour prototypical to that of the unit' (theory Y) management approach, and secondly, the coaching and grooming of these individuals as and where necessary in creating a ‘united front’ and ensuring that the “organisation outlives any single individual” (Ulrich et al., 2008, p. 16).



entrepreneurial behaviour and innovativeness (Ellis, Hollenbeck, Ilgen, Porter, West, & Moon, 2003), and are generally more suited for organisations reliant on flexibility for survival and that operate in more complex and uncertain environments (Daft, 2008). Moreover, because approval usually only needs to come from one level higher or can be affected by the person confronted with the decision themselves, the speed of decision-making can be increased (Elsaid et al., 2013) and as a consequence, customer needs can better be served (Matheson, 2013). As more contemporary matrix and project structures are considered to have many of the characteristics of such 'organic' configurations, these can be offered as examples of flatter, more decentralised and flexible prototypes that can be fruitfully employed. (See Table 2.8 for a detailed comparison between mechanistic and organic structures).

Table 2.8

*Differences between mechanistic and organic structures*

MECHANISTIC	DIMENSION	ORGANIC
Predictability	Goal	Adaptability
Stable	Environment	Dynamic
Vertical (top-down)	Information flow	Multi-directional
Underutilised, inhibited	Employees	Utilised to full potential
Narrow	Spans of control	Wide
Specialised	Tasks	Cross-functional
Formal and impersonal	Authority	Informal and personal

While, up until recently, the organisational structure literature has rather unequivocally supported a contingency<sup>79</sup> view, and that there indeed are a number of trade-off guidelines to consider before settling on a specific configuration, lately there appears to be some agreement that a radical re-examination of more traditional approaches to structural configuration is required. Pressure deriving from the need to implement new business models in uncertain and dynamic environments and the need for innovation have led to a shift whereby traditional work structures revolving around individuals are changing towards organisational structures that are more team-based and geared towards change (Lawler & Worley, 2006; West & Markiewicz, 2004). More specifically, an increasing number of authors have started to support the Theory Y/organic view, not only because the business landscape has necessitated such a paradigm shift but also because of the motivational qualities that such structures might unlock. For example, Robbins and Decenzo (2008, p. 12) challenge centralised decision-making structures by asserting that in today's turbulent business environment, organisations "are more likely to need to adapt quickly to change, and thus (need to) decentralise decision-making." Vroom (2006) agrees with this viewpoint, arguing that the effect of increased global competition has necessitated the employment of more organic, flexible structures as a means to compete effectively. In further debating the merits of centralised versus decentralised decision-making structures, Matheson (2013) concludes that effective customer interaction demands breadth of authority and organisation-wide participation in decision-making (i.e. the authority to make on-the-spot decisions to meet customer needs). Mishra and Morrissey (1990) in turn, demonstrated that decentralised decision-making leads to increased levels of trust and group cohesion in a unit's *human subsystem*. The possible interaction effect between participative decision-making structures and the values embedded in the *strategic subsystem* is highlighted by Greenberg (1990) and Konovsky (2000) who suggest that the encouragement of participative decision-making will provide employees with the opportunity to voice their opinions, which in combination with an overarching culture of fairness and creativity, can combine to establish a work unit climate supportive of additional beneficial outcomes such as job satisfaction, organisational commitment,

<sup>79</sup> Apart from the complexity and the uncertainty/dynamism of the environment, the choice of an appropriate work structure is believed to also be influenced by the type of work the unit is concerned with, the range of its products/services, its size in terms of number of employees, the geographic dispersion of its facilities, and its revenue stream and market strategy (Demsetz, 1988). These factors impose constraints on organisations that, to a certain extent, can force leaders to choose a certain structural design over another (Bourgeois, McAllister & Mitchell, 1978; Duncan, 1972; Snow & Hrebiniak, 1980).

and organisational citizenship behaviour (Colquitt, Conlon, Wesson, & Porter, 2001) in the *human subsystem* as well. Similar to mechanical organisation structures, organic organisation structures therefore also tend to elicit employee behaviour that bears out the implicit employee assumptions underpinning the design principles of the organic organisation structure.

Regarding the flow of information, Bentley (1995) believes that organisations require less rigid frameworks/structures to allow the effective flow of information within a work system. Sankar's (2003, p. 504) scathing remarks regarding the interdependencies that exist between centralised decision-making structures and the associated corrosion of information flow, mirrors this viewpoint and provides a supportive illustration of the potential superiority of organic structural configurations:

The centralisation of authority of decision-making at the strategic apex legitimises these communications channels. Information filtration in the classical design is a major pathology of the system. Information overload in the organisational hierarchy is a common feature of the system. Information distortion because of bureaucratic codes, symbols, operations manuals and specialised information taxonomies is another pathology of the classical design. Feedback on change initiative at lower levels of the hierarchy is quite limited and with extensive lags.

Thus, mechanical structures place “potentially dysfunctional information processing burdens on key individuals and groups as they seek to skilfully steer the organisation over the longer-term” (Hodgkinson & Sparrow, 2006 p. 2). However, in addition to these potential pathologies, the power dynamics associated with authoritative decision-making structures constitute a further potential danger of the employment of mechanical structures. In this regard, Zaccaro et al. (2001, p. 476) have criticised the conformity pressures that arise from authoritative, top-down decision-making practices that eventually “result in each individual adopting with little question the patterns discerned by their superiors, even if such patterns are inaccurate”.

Elsewhere, consistent with arguments relating to employee role expansion and empowerment, Hammer and Champy (1993) champion the use of Business Process Engineering (BPR) and weigh in by calling for a shift from a division of labour towards the *combination* of labour to break down functional silos and broadly configure teams around more effective, and customer orientated business processes instead. Pettigrew (1998) and Hammer and Champy (1993, p. 32) also criticise the standard solution<sup>80</sup> to structure and point specifically to the functional configuration's inability to meet “critical, contemporary measures of performance, such as cost, quality, service and speed”. Thus, “the trend in recent years” has necessitated businesses to “reduce costs, speed up decision making, increase flexibility, get closer to customers, and empower employees” (Robbins, Odendaal, & Roodt, 2003, p. 111), which has ultimately directed management efforts towards the adoption of a hybrid approach – i.e. more organic structural configurations that can exploit current competitive advantages while simultaneously developing new ones. Two work unit competency potential variables are referred to by Hoskisson, Hitt, and Ireland (2007) as *structural stability* (the capacity to consistently and predictably regulate the daily work routines) and *structural flexibility* (the exploration of competitive advantages through the utilisation of the potential of the collective). Ultimately these views not only align with the needs of a generation of followers that value participative leadership (Maccoby, 2000) and demand freedom to work in their own way (Martin, 2005), but they furthermore illuminate the manner in which leaders can shape *structural competency potential* variables of the work unit to achieve *resonance* between actors through the employment of more ‘self-managed’, cross-functional work process teams that encourage, rather than impede creative, autonomous work behaviour and learning (Tran & Tian, 2013); promote a more participatory environment

---

<sup>80</sup> Daft (2008) argues that most managers today simply accept mechanistic structural configurations as the only way that labour can be organised. “The ... challenge is to identify alternatives and develop theories that account for them” (Child & McGrath, 2001, p. 1136).

conducive to communication, commitment and involvement amongst organisational members (Chen & Huang, 2007), and facilitate cross-fertilisation of skills between professionals (Hoult, 1986).

In turning the discussion specifically to a unit's *technological subsystem*, Hammer and Champy's (1993) support of BPR offer insight into a leader's potential role within the work unit's conversion process. This business (and change) management tool advocates the replacement of functional structures with critical workflow structures, often framed as core organisational processes, which can more readily be optimised to align with contemporary customer requirements regarding speed, service, cost and quality (Hammer & Champy, 1993). In explaining the underlying rationale, as well as the way in which BPR is fully compatible with organic structural configurations, Daft (2008, p. 263) argues as follows:

Because the focus of engineering is on process rather than function, reengineering generally leads to a shift away from a strong vertical structure to one emphasising stronger horizontal coordination and greater flexibility in responding to changes in the environment... Reengineering changes the way managers think about how work is done in their organisations. Rather than focusing on narrow jobs structured into distinct, functional departments, they emphasise core processes that cut horizontally across the company and involve teams of employees working to provide value directly to the customers.

Given this new development, a leader's role<sup>81</sup> can be extended to that of a **productivity manager** in that the structural decisions made should incorporate an analysis of how the current workflow can be optimised so that the core processes eventually embedded in the technological subsystem (work unit competency potential) can consequently maximise the speed, reliability, adaptability and quality (competencies) of the unit, which in turn will increase the unit's general propensity to compete by way of a variety of generic market strategies (i.e. low price or high margin, wide product range, frequent introduction of new products, shorter lead times or dependable delivery). In elaborating on this aforementioned role, Cameron and Quinn (2006) draw attention to a coordinative function<sup>82</sup> of leaders orientated towards the internal process functioning of organisations who, at least initially, during the 'first-run' implementation of a conversion process, are required to draw all of the (newly) implemented components together, to quality assure the (new) value chain, and to make interpretations and decisions for encumbered members in moving the team along (Hinsz, Tindale, & Vollrath, 1997; Kozlowski, Gully, McHugh, Salas, & Cannon-Bowers, cited in Ferris, 1996).

Thus, although it has previously been argued that a leader can shape followers' actions and behaviours towards such a state of unified functioning through their impact on certain work unit competency potential variables located in the *strategic subsystem* via the entrenchment of an effective and integrated vision, strategy, culture and organisation structure (i.e. the *structural subsystem*), Cameron and Quin (2006), in contrast support more direct, results-driven tactics to intervene during actual *technological subsystem* operations in real time. Such orchestrations in which disparate and differentiated workflow actions/components are integrated in concert with temporal pacing (Argote & McGrath, cited in Cooper & Robertson, 1993; Marks, Zaccaro, & Mathieu, 2000) to affect consequent team synchronicity (Zalesny, Salas, & Prince, cited in Ferris, 1995) require leaders to maintain a hands-off procedural view (Andersen, Jensen, Lippert &

---

<sup>81</sup> The employment of more organic structures as well as the utilisation of BPR in the unit's conversion process aligns with arguments previously aired regarding the leader's requisite roles in the strategic subsystem as well – i.e. pushing down accountability for strategic foresight in the development of front-line strategists, the nurturing of a culture of creativity, innovation, etc.

<sup>82</sup> At this point a comparison can again be drawn to general systems theory and the proposed recurring nature of *homeostatic* functioning of open systems in particular, in that the theory suggests that such systems will tend to differentiate (i.e. functional reordering) to counter dynamic environmental complexities/challenges, resulting in a state of 'free-fall' which in turn, will inevitably need to be countered internally through the use of coordination devices (Katz & Kahn, 1978) that the *managerial subsystem* brings to the unit for unified functioning (Von Bertalanffy, 1950) to ensue once more.

Ostergaard, 2010) that frees them up to execute in-process corrections<sup>83</sup> as and when required to ensure that the different components of the conversion process are pulling in the same direction (Kraut & Streeter, 1995) by way of three interrelated forms of intervention,<sup>84</sup> namely: a) orientation, b) resource distribution, and c) timing/sequencing functions.

The *orientation function* involves the ongoing conveyance of information pertinent to task accomplishment (Lanzetta & Roby, 1960) in response to cycling load demands placed on unit members' cognitive and behavioural resources (Kozlowski et al., cited in Ferris, 1996) as performance requirements shift in focus. This is supplemented by information on each member's and the changing environmental resources and constraints, the shifting priority assigned to the accomplishment of each task (Zaccaro et al., 2001) as well as pointing out new forms of interactions, exchanges, and interdependencies between members vital for project success. These messages conveyed via project or update meetings, serve to (re)calibrate the collective's mission and goals, the required member contributions, as well as apprise followers of each member's mutable behavioural and information requirements and how the unit might adjust to the changing situation (Kozlowski et al., cited in Ferris, 1996). Thordsen and Klein (1989) argue that such sessions provide the leader with the opportunity to simulate challenging aspects of the conversion process, a strategy that McNealy (1999, p. 15) describes as a "walk-through of the battle plan", that systematically exposes the unit to an array of "scenarios in which, through guided practice and feedback, (the unit) may develop the knowledge structures necessary for rapid and accurate situational awareness" (Shrestha, Prince, Baker, & Salas, 1995, p. 133). While this type of information is clearly crucial in establishing a foundation for new members that join the team or initially when cascading the organisation's strategy throughout the work unit, dynamic and changing conditions can also necessitate leaders to convey adjustments or refinements to the overall plan during the actual implementation thereof (Zaccaro et al., 2001). The importance of facilitating such unit's situational awareness<sup>85</sup> (SA) within this context is also highlighted by Kazlowski et al. (cited in Ferris, 1996, p. 280), who stress the necessity of the provision of "situation updates to team members, ... information on how the team is doing, what it should be doing... how it might adjust to the changing situation, ... (and) what events might be expected to occur in the future".

The *resource distribution function* concerns the manner in which material and human resources are (re)assigned to the different core business processes and holds obvious implications for the consequent levels of effectiveness at which each respective process can be expected to operate. While a possible lack of materials and manpower speaks to the leader's success with which they can broker these resources,<sup>86</sup> the tactical assignment and moving of materials and personnel to and between specific tasks in the balancing of task load and demands across different core business processes (Zaccaro et al., 2001) amidst changing environmental conditions constitute further leadership responsibilities that if ignored, can likewise cripple team efforts. With regard specifically to human resource utilisation, this points to the effective balancing of team composition as a further critical leadership function as the unit's potential for success is greatly enhanced when the right mix of talent is in place (Hackman, 2002; Wageman, Hackman, & Lehman, 2005) in different areas of the conversion process and when "gifted people with

---

<sup>83</sup> Consistent with the promotion of self-managed teams, the idea is for leaders to relinquish control as teams become more mature. However, the leader can also take back some control when the operating environment necessitates them to do so.

<sup>84</sup> Fleishman and Zaccaro (cited in Swezey & Salas, 1992) initially presented these as 7 distinctive functions. The current study however, has taken the liberty to adapt this interpretation and to reduce their taxonomy into 3 functions as provided above, as the balance of their functions will be covered elsewhere in the study.

<sup>85</sup> SA has recently emerged as a further related collective construct of interest in organisational behaviour literature given growing concerns over the effectiveness of team decision-making under the ever-increasing technological and situational complexities that employees are faced with in the modern world of business (Saner, Bolstad, Cuevas & Gonzales, 2009).

SA is interpreted in the current study as a networked behavioural construct, or a collective group process, (i.e. a work unit competency) and refers to a team's ability to engage in "coordinated perceptions and coordinated actions" (Gorman, Cooke, & Winner, 2006, p. 1314).

<sup>86</sup> This was argued to be one leadership function within the work unit's strategic subsystem.

different skills capable of moving in the same strategic direction” (Ulrich et al., 2008, p. 87) are optimally (re)deployed and combined within differing task and team parameters (Mohammed, Ferzandi, & Hamilton, 2010; Zaccaro & DiRosa, 2012). Regardless, the optimisation of both the staff complement (i.e. human resources) as well as the on-site materials, facilities, and budget allocation (material resources) requires the cultivation of a deep understanding of the different core business processes located within the conversion process as well as the talent portfolios of the followers tasked with staffing them. This provides the essential foundation for resource allocation and demand forecasting. Accordingly, unit coordination can be enhanced through a leader’s understanding of where in the value chain specific sets of competencies/expertise are located, needed, and can be accessed,<sup>87</sup> and by enhancing the insight to (re)direct skill sets, funds, information, or other physical resources to shifting areas of priority.

Finally, the *timing/sequencing* leadership function incorporates the temporal pacing of different core business processes and constitutes a further central precondition for collective coordination (Argote & McGrath, cited in Cooper & Robertson, 1993). In essence, this function requires leaders to regulate the speed of task completion for both the collective as well as individual members (Zaccaro et al., 2001), while taking account of the nature of the sequencing architecture according to which tasks are structurally configured within the *technological subsystem*. Again, the ability to do so effectively is predicated on a deep understanding of the technology utilised in the unit and its members’ experience and expertise; however, the successful use of such knowledge within this context requires a systemic application that is necessary to connect member activities and the product(s) of their work with that of others (Kozlowski & Bell, cited in Borman, Ilgen, & Klimoski, 2003) in the same chain and with the overall deadlines of the collective as a whole.

In recognising the fact that team failure may also be caused by the inability of the collective “to coordinate and synchronise their individual contributions” (Zaccaro et al., 2001, p. 451), the above points to several important leadership functions requiring attention when implementing a new conversion process, or when confronted with “environments that become particularly complex and multifaceted” (Zaccaro et al., 2001, p. 464) for the team to handle by themselves. However, the expectation is not that leaders who operate at a strategic level should divert their total, undivided attention to such coordinative functions, but rather that they should lay the necessary groundwork at an early stage for these “to become fairly automatic behaviour patterns displayed by team members, individually and collectively (Zaccaro et al., 2001, p. 475) as “controlling large organisations... is beyond the competence of one single individual. Instead, a team works co-operatively, and often synchronously, to coordinate and control the environment” (Da Ruan, Lu, & Wu, 2007, p. 315). Kozlowski’s (cited in Cannon-Bowers & Salas, 1998, p. 134.) appeal to leaders as to the proper way in which teams should be managed mirrors a Theory Y argument as well as summates the intended end result of a leader’s role as a project manager within the unit’s conversion process:

Leaders are not so much responsible for directing specific team actions as they are responsible for developing the underlying individual and team capabilities that enable teams to self-manage their actions.

Thus, consistent with some of the previous arguments raised concerning the employment of a Theory Y management approach, the team is not to become reliant on the leader for such directive forms of support (Morgenson et al., 2010) and should be encouraged to take over these functions and ultimately be able to “manage their own efforts” (Sims & Manz, 1984, p. 416). In light of the foregoing arguments, leaders can then be held responsible for embedding a unit structure conducive to functional information flow, collaboration/synergy (cohesion), and the configuration of a conversion process that enables the unit to execute the leader’s strategy and to meet the contemporary performance requirements of cost-efficiency, speed, quality and high

---

<sup>87</sup> Kozlowski, et al. (cited in Ferris, 1996) contend that leaders thereby coordinate the contribution and integration of team knowledge and information resources by balancing them in the team in areas where gaps occur.

standards of (customer) service. Table 2.9 below provides a detailed summary of the generic leadership competencies that were harvested from the hypothesised leadership responsibilities in support of the achievement of these competency results in the unit's structural and technological subsystems.

Table 2.9

*Leadership competencies extracted from the structural and technological subsystems*

COMPETENCY	COMPETENCY DESCRIPTION	COMPETENCY	COMPETENCY DESCRIPTION
Business process (re)engineering	<i>Analyses unit strategy and the availability/sustainability/cost efficiency/environmental impact of different input resources in the environment to design 'best in class' workflow processes (i.e. the conversion process) for executing the plan.</i>	Collaborative work structuring	<i>Organises unit (organogram) into a single, horizontal network structure around the conversion process that comprises of multi-purpose positions collectively responsible for its execution.</i>
Minimises span of control	<i>Inserts a flat management level into the unit's structure with a wide span of control.</i>	Expands work roles	<i>Followers are delegated fluid, multi-purpose job roles and job descriptions are developed and communicated to reflect these expectations.</i>
Deploys supportive management	<i>Selects, coaches and grooms competent front-line managers/supervisors to relinquish power and redefines their roles in the structure to provide guidance and support to followers instead.</i>	Delegates authority	<i>Encourages and legitimises followers to make on-the-spot decisions relating to their various areas of responsibility. Followers are authorised to plan and manage their own work.</i>
Dismantles bureaucratic constraints	<i>Removes overly prescriptive, inhibiting policies, rules and procedures that control/inhibit the way in which work is done in the unit and that constitute unnecessary 'red tape'.</i>	Downplays positional power	<i>Actively de-emphasises the existence and use of power and authority differences between employees and managers/supervisors in the unit.</i>
Facilitates participative decision-making	<i>Encourages, legitimises and supports inclusivity in and the challenging of (higher level) unit decision-making and employs structures in support of this philosophy.</i>	Creates channels for follower voice	<i>Mechanisms are put in place for followers to spontaneously contribute their ideas for improvements and action is taken on viable suggestions.</i>
Enhances communication flow	<i>Develops mechanisms for teams to deliberately share information with each other (file-sharing, weekly shared meetings, etc.), looks for barriers to information flow and removes them.</i>	Provides situational updates	<i>Provides feedback to the unit on progress and articulates refinements/adjustments to be made to the status quo and priority shifts required to remain on course.</i>
Balances material resources	<i>Balances the deployment and utilisation of material resources (budgets, facilities, equipment, etc.) between different core business processes amidst particularly challenging situations.</i>	Balances human resources	<i>Continuously (re)deploys the correct mix of individuals (in terms of competencies, knowledge, experience, etc.) in balancing the competence sets required within the different core business processes amidst particularly challenging situations.</i>
Manages work sequencing	<i>Acts to move encumbered individuals/teams along where necessary in ensuring that all unit components remain working in concert with each other and that critical, interdependent timelines are met.</i>	Simulates challenging environments	<i>(Artificially) exposes followers to various challenging scenarios to develop their ability to self-adapt and adjust their structure and priorities to counter situational demands.</i>

### 2.6.2.3 THE HUMAN SUBSYSTEM

It has thus far been argued that an organisation's interrelated strategic, structural and technological features (i.e. strategy, organisational structure, workflow design, etc.) if optimally configured, aligned and managed, can enhance the performance potential of a work unit. However, "beyond just alterations to operational systems and structures, effective... (leaders) need to address the deeper issues associated with human networks" (Cross et al., 2013, p. 84) as well. Organisations are constituted by the human subsystem. An organisation's interrelated strategic, structural and technological features are brought to life by the human subsystem. Human subsystems emerge as a result of interactions with the other strategic, technological and structural subsystems. This formation process whereby employees' organisational lives are imbued with psychological affect (Bouckenooghe, Raja, & Butt, 2013) is complex and dynamic, and the personal meaning that employees extract from organisational features (structure, work assignments, policies, etc.) as well as the manner in which social constituencies (colleagues, top management, supervisors, etc.) enact their roles and reciprocally engage and make exchanges at work (Steiner, 1972) determines the human subsystem's distinctive properties (Parsons, 1951). Thus, these social interactions as well as perceived job and contextual characteristics are factors that shape employees' psychological states, which in turn have been proven to be important in determining a number of important job (and probably also personal) outcomes (Judge & Watanabe, 1993) such as in-role job performance, extra-role performance (Chan, et al., 2008) number of days' sick leave taken (Spector, 1994), turnover intention (Aryee & Chen, 2006), and absenteeism, (Bourbonais, Vinet, Meyer, & Goldberg, 1992)

Human subsystem potential, however, may reside not only in these properties, (individual member psychological wellness and states that impact work performance) but also in the success with which members can coordinate and synchronise their individual contributions (Zaccaro et al., 2001) and psychological make-up into a well-functioning team at a *collective* level of study. This is why it has been suggested that focus should be directed at perhaps a more important, yet less investigated area of human subsystem effectiveness (Zaccaro et al., 2001) that studies the synergies that produce (team) process gains (Hackman, cited in Lorsch, 1987) and collective psychological potential. Indeed, given the goals of the current study that envision the explication of a structural, strategic leadership performance model aiming to position leadership as the central driver of *collective* work unit functioning, "it is impossible to understand team effectiveness without paying attention to the processes that unfold over time to yield it" (Kozlowski & Bell, cited in Borman & Ilgen, 2003, p. 335). "Team processes reflect the way that teams handle tasks and interpersonal dynamics" (Mickan & Rodger, 2005, p. 365) and therefore represent one leadership "mechanism that (can) inhibit or enable the ability of team members to combine their capabilities and behaviour" (Kozlowski & Bell, cited in Borman, Ilgen, & Klimoski, 2003, p. 26) into a collective force. Despite the extensiveness of team processes literature various authors, however, hold differing views on the subject and unfortunately therefore no uniform set of core processes emerges (Kozlowski & Bell, cited in Borman, Ilgen & Klimoski, 2003) that the current study can wholly appropriate. An integration of some of the views of Kozlowski and Bell (cited in Borman, Ilgen & Klimoski, 2003), Zaccaro et al., (2001), and Cameron and Quinn (2006), nonetheless yields an informative start-up guide that can be utilised for this purpose. Here, a differentiation is made between cognitive and motivational/affective *collective* constructs, and it is proposed that leaders can influence the human subsystem effectiveness in part, through their effect on these constructs.

Shared mental models and team learning represent the key collective cognitive constructs that are believed to promote team effectiveness. *Shared mental models* comprise four content domains (Cannon-Bowers, Salas, & Converse, cited in Castellan, 1993) of knowledge (See Figure 2.12); about key elements of the task environment (Klimoski & Mohammed, 1994); including the *equipment* (knowledge of the technology used); *task* (knowledge of the conversion process including performance requirements, objectives and possible barriers to success); *member*



(awareness of other members' habits, routines, strengths, weaknesses, beliefs, and expertise); and *team* knowledge models (knowledge and beliefs about how the team functions optimally and the individual contributions to enable that) that facilitate "connections and linkages" between the various "roles/behaviour patterns required of individual members to successfully enact collective action" (Zaccaro et al., 2001, p. 459). These shared knowledge domains are believed to form and become more powerful over time as individual members interact with and observe one another while performing their respective job roles within a team. The formation of the team (interaction) model is more complex however, in that the equipment, task and member models "are presumably crucial building blocks" (Zaccaro et al., 2001, p. 460) in its creation and therefore require an integrated perspective on the other, 'first order' knowledge domains first.

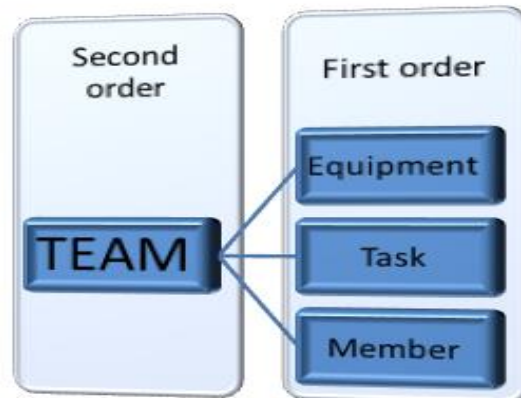

Figure 2.12. A graphic representation of shared team mental models

Accordingly, the 'higher order' (interaction) team model, when properly formed, is believed to be the most significant domain as it is only through the encoding of an integrative perspective of the task environment that group action can be regulated (Zaccaro et al., 2001). Thus, the strategies and tactics that result from an analysis and understanding of the 'first order' models "become incorporated into the team interaction model" (Zaccaro et al., 2001, p. 460), and it is through a shared perspective on this knowledge domain specifically that the group can anticipate each other's actions for subsequent improvement in the quality of group coordination (Zaccaro et al., 2001) and communication (Zaccaro et al., 2000) to occur.

Although many researchers disagree about the precise detail involved in the conceptualisation of the *team learning* construct, Edmondson, Dillon, and Roloff (2007) propose a relatively broad, yet practically useful operationalisation thereof by describing the concept within the context of positive change that occurs as a result of investment in the formation of shared knowledge, insight, or competence in group settings. While there are similarities to be observed between the shared mental model and learning constructs in that the basis for both relates to shared knowledge acquisition, it is important to point out that the former focuses on the learning of "the interaction patterns necessary for team success" (Zaccaro et al., 2001, p. 476) through a shared understanding of "what is", while the latter is believed to operate through *collective metacognition*; the potential to generate new, novel knowledge of 'what can be' or 'what we can do better' through collective *ex post-facto* reflection on specific task or problem situations (Zaccaro et al., 2001). This type of careful and structured *intervention* involves a consideration of the way that the team constructed problems, "evaluated possible solutions, and implemented the selected solutions" (Zaccaro et al., 2001, p. 460). Hence, *collective metacognition* is believed to take place when "team members set aside time to consider... the consequences of their strategies, how they considered and arrived at a team solution, and how they worked together to implement selected solutions" (Zaccaro et al., 2001, p. 460).

While both mental models and team learning may evolve and develop naturally over the course of a group's life cycle, leaders can also play a central role in expediting these processes. For example, Zaccaro et al. (2001, p. 461) contend that a "major responsibility of the ... leader is to facilitate for team members an accurate and shared understanding of their operating environment and how, as a team, they need to respond." In this regard, "leader information search and structuring activities provide the grist for meaning making and sense giving to team members, allowing the development of more comprehensive and effective team models" (Zaccaro et al., 2001, p. 461). The focus here is not so much on the actual ability of the leader in terms of the effectiveness of the strategy developed or the structure embedded, however, but rather on effectiveness with which this leads to the transfer of key underlying messages. The communication, translation and cascading of the unit's strategy then represents a further key step in the leadership process as explained by Zaccaro et al., (2001, p. 462):

This step is a critical one for team leaders because if they develop a perfect plan for team problem solving, but cannot communicate the model or plan effectively to the team, then the team response is likely to be inadequate. If this communication is successful, then team members are likely to form and share an accurate model of expected behaviours and role requirements.

Regarding team learning, leaders can facilitate positive changes in shared knowledge, insight and/or competence in teams by influencing the "quality and efficacy of collective information processing, especially metacognition" (Zaccaro et al., 2001 p. 461) as well. This can be achieved by employing a hands-on approach, at least initially, by the leader monitoring discrete team performance episodes (Tannenbaum, Smith-Jentsch, & Behson, cited in Cannon-Bowers & Salas, 1998) and organising interventions (i.e. quality circles) upon conclusion of major projects (Kozlowski et al., cited in Ferris, 1996) to provide collective feedback and facilitate team planning activities for the team in activating the collective 'metacognitive processing' potential of the group. Thus, the act of verbalising learning points as well as the encouragement, modelling and coaching (Cannon & Edmondson, 2001) of problem identification, fact-finding and effective solution generation (Kozlowski et al., cited in Ferris, 1996) represent further critical leadership functions in enabling the collective competency potential of a work unit. In describing team leader actions that can promote psychological safety, Edmondson (2003) is of the opinion that managers can also expedite team learning by encouraging "speaking up in service of learning" (p. 1419) and by de-emphasising power differences between themselves and the followers. Zaccaro et al. (2001) concur with this view and posit that: "when authority relationships are weakened, or at least suppressed, lower ranking individuals are likely to contribute more readily to the identification of meaningful patterns in the organisation's environment" (p. 476). Moreover, the creation and diffusion of an organisational culture in the unit's *strategic subsystem* that nurtures the values of trust, tolerance for mistakes, creativity, and fair treatment as have been previously suggested, is likely to trickle down to the human subsystem and create an environment thereby contributing to a perception of psychological safety in support of learning as well (Edmondson, 2003).

The four most frequently cited motivational/affective constructs that are thought to operate and impact work performance at a group level include *efficacy*, *back-up behaviours*, *cohesion*, and *conflict*. *Collective efficacy* is a construct first proposed by Bandura (1986; 1997) as an extension of self-efficacy theory, which holds that efficacy beliefs in individuals emerge in part from observations of others' behaviours that lead to successful performance, an actual personal history or track record of successful achievements, as well as persuasion and social influence processes that bring about such beliefs in the individual. If these principles are extended to a group context, collective efficacy can be similarly explained and defined as a team psychological state (i.e. work unit competency potential variable) that reflects the members' confidence that the collective can be successful in performing a particular task or project (Zaccaro, Blair, Peterson, & Zazanis, cited in Maddux, 1995). The value of collective efficacy is thought to be quite wide-ranging in that a conviction in the team that work activities can be carried out skilfully and successfully (Bandura,

1977) can positively moderate the effects of a range of negative work demands (e.g. introducing a new product, the implementation of cost-saving measures, etc.) impacting the team at work. Zaccaro et al. (2001, p. 467) share a convincing narrative that attests to the value of self-efficacious teams as a *work unit competency potential variable* that can moderate important work unit performance outcomes:

As members feel more confident in their team's capabilities, they are more motivated to work hard for the team, persist in the face of collective obstacles, and are willing to accept more difficult challenges... Consequently, under extreme adversity, highly efficacious teams should perform better than groups having low collective efficacy.

As powerful individual efficacy beliefs are largely formed on the basis of a successful track record, the observation of others' behaviours that lead to successful performance, and through persuasion and influence to bring about such beliefs in the individual (Bandura, 1982), these principles are likely to be relevant to and can therefore be applied by leaders in developing task confidence in groups (Kozlowski et al., cited in Ferris, 1996) as well. For example, by modelling appropriate task strategies and teamwork behaviours, leaders can facilitate the process whereby followers first imitate and eventually come to automate critical collective task competencies (Kozlowski et al., cited in Ferris, 1996). Thus, it is argued that if a leader acts as a role-model in championing effective work strategies, (i.e. professionalism, punctuality, mutual support, project planning, etc.) that teams will follow this example, come to assimilate these behaviours and as a consequence, be "likely to feel more efficacious with respect to its assigned tasks" (Zaccaro et al., 2001, p. 486).

Similarly, it has been argued that a leader's success with which they can augment follower efficacy beliefs is dependent on the degree to which the leader possesses and expresses positivity – or demonstrates positive appraisal of situations expressed in the form of hope, resilience and optimism (Avolio & Gardner, 2005; Luthans & Youssef 2007) as well as the belief that success is attainable (Norman, Avolio, & Luthans 2010). Thus, leaders that demonstrate a hopeful mindset tend to generate hopeful thinking and action in followers (Helland & Winston, 2005) as well. Breakthroughs can likewise be achieved if a leader can affect quick successes in a team, especially at an early stage in a team's development, so that the group can build on this successful accomplishment and from there grow their sense of competence. "As more attributions are made towards internal ones (a "we can do it mentality") this serves to increase self-efficacy among leaders and followers alike" (Hodgkinson & Sparrow, 2006 p. 14). Such breakthroughs and attributions of an internal locus of control would naturally be more likely and efficacy beliefs more powerful and probable if the work unit's strategy and structure are perceived to be effective and supportive of team success. Finally, Zaccaro et al. (2001) speculate that the encouragement and exhortation of excellence in a team represent further options at a leader's disposal in persuading or influencing followers in believing, and ultimately realising their full potential. Such encouragement can be done directly by leaders who back and inspire their followers to perform, but it can also be realised through more indirect channels such as the nurturing of a performance-orientated culture in the *strategic subsystem* that filters down to the human subsystem to reinforce performance excellence there.

Cohesion, on the other hand, is perhaps one of the most extensively investigated constructs in the history of group dynamics literature (Casey-Campbell & Martens, 2009); yet disagreement in terms of its precise definition and connotative meaning/operationalisation unfortunately still plagues efforts to provide a universally accepted constitutive definition of the construct (von Treuer & McLeod, 2013). In general, however, cohesion is thought to develop as a result of the special inclination and capacity of human beings to forge close personal bonds (Carron, 1982) with others that they interact with, resulting in synergistic interactions insofar as "members of a team relate and work together" (Aoyagi, Cox, & McGuire, 2008, p. 30) that ultimately leads to

performance benefits at both the individual (Chang & Bordia, 2001) and collective<sup>88</sup> (Dion, 2000) levels. Research has demonstrated that cohesive groups generally outperform non-cohesive groups (Evans & Dion, 1991; Straus & McGrath, 1994) in a number of different settings such as military and sports (Dion, 2000), and that the existence of such fortified interpersonal relationships yields less inhibited communication (Kozlowski & Bell, cited in Borman, Ilgen, & Klimoski, 2003), high levels of interpersonal member trust (Ensley & Pearce, 2001), as well as reduced relationship conflict (Ensley & Pearce, 2001), and greater coordination (Kozlowski & Bell, cited in Borman, Ilgen, & Klimoski, 2003) in teams. Although the degree of agreement varies,<sup>89</sup> researchers generally acknowledge that the cohesion construct is multidimensional (Sánchez & Yurrebaso, 2009) and comprises of (at least) two components: (Carless & De Paola, 2000; Dyce & Cornell, 1996; Zaccaro & Lowe, 1988): *social or interpersonal cohesion*, (i.e. member attraction to the group and the number and intensity of friendships), and *task cohesion*, (i.e. commitment to and belief in the instrumentality of achieving individual goals through the group).

Despite the fact that it has been proposed that both forms of cohesion must be present for teams to excel (Hoffman, Kinlaw, & Kinlaw, cited in Cleland, Pinto, & Slevine, 2002), other research stream results seem to indicate that task cohesion is the more important variable (Mullen & Cooper, 1994) in the cohesion-performance relationship, specifically when group tasks are interdependent (Gulley, Whitney, & Devine, 1995), and that social cohesion could even impede productivity efforts through task-interfering exchanges among group members (Zaccaro & Lowe, 1988) under certain conditions. Regardless, as the balance of the research evidence suggests that cohesion “is fundamental to the fabric of group and social functioning” (von Treur & McLeod, 2013, p. 1) and is interrelated with other collective constructs such as a team’s sense of self-efficacy (Zacarro et al., cited in Maddux, 1995) levels of interpersonal trust (Lawler, Thye, & Yoon, 2008), level of participation in decision-making (Mishra & Morissey, 1990) and levels of coordination (Kozlowski & Bell, cited in Borman, Ilgen, & Klimoski, 2003), the construct remains an attractive avenue for further exploration in the search for performance directives applicable to future graduate leaders.

While group cohesion can develop naturally over time as members come to understand, appreciate and value each other’s contributions and friendships, Druskat and Wheeler (2003) and Van Vugt (2006) believe it is an important part of a team leader’s job to expedite and nurture such evolutions in teams. Consistent and compatible with some of the arguments already aired, George and Jones (1998) propose that leaders can facilitate such cohesion simply through the employment of more organic structures that will naturally “increase cooperation between people by re-engineering their structures into flatter, more team-based forms, in which authority is decentralised to empowered lower level employees” (p. 541). This assertion is compatible with the views of Harrison, Price and Bell (1998), Lam and Man (2004), and Seers, Petty and Cashman (1995), who demonstrated that higher levels of interaction among group members, the employment of self-managed teams, and an increase in job complexity and task autonomy respectively tends to yield higher levels of cohesiveness. In addition to the employment of such supportive strategies in the *structural subsystem*, Sánchez and Yurrebaso (2009) maintain that culture represents another work unit competency potential variable that can contribute to the development of tightly knit groups, if properly nurtured in the *strategic subsystem* of the work unit.

---

<sup>88</sup> Consistent with the argument previously aired that describes the operation of feedback loops in competency models through which outcome latent variables can affect specific (malleable) competency potential variables, Mathieu, Kuenberger, D’Innocenzo and Reilly (2015) suggest that team performance (i.e. outcome variable) and cohesion (i.e. malleable competency potential variable) are reciprocally related and that this relationship can grow stronger in intensity over time.

<sup>89</sup> For example, Carless and De Paola (2000) along with some other authors (e.g. Evans & Jarvis, 1980; and Sánchez & Yurrebaso, 2009) have suggested that individual attraction to the group constitutes a further related component in fully understanding the cohesion construct.

On this point however, the main consideration is that the culture should be both supportive of cohesion (i.e. values of community, support, etc.) as well as strong in the sense that these cultural norms and values should be widely shared and deeply rooted throughout the organisation (O'Reilly & Chatman, cited in Cummings & Staw, 1996). It follows that strong cultures with values that stand in support of solidarity firstly increase cohesiveness, and that secondly, "the more group members share (these) values, beliefs, and cultural norms, the more they will feel attracted (to the group) and the greater the group cohesion level" (Sánchez & Yurrebaso, 2009, p. 98).

Regarding possible contributions to effect values of solidarity in support of such a culture,<sup>90</sup> Hogg (2001) believes that leaders can develop a cohesive *identity* in the unit by expressing beliefs and behaviours that emphasise their commitment to these values (i.e. *prototypical cultural* behaviours), while Haslam, Reicher and Platow (2011) and Nelson and Quick (2003) argue that such identities can be expedited by leaders who advance group interests (i.e. fighting for 'us' and 'our rights') to create an exclusive '*in-group*' mentality in the unit. Mael and Alderks (1993), in turn, point to the fact that most studies in the area demonstrate a link between directive leadership and reduced cohesion, and thus implicitly advocate that compassionate support may similarly be an important aspect to consider in the development of a unit identity in support of cohesive groups. Indeed, in a laboratory experiment examining the impact of a leader's supportive actions, Phillips, Douthitt, and Hyland (2001) found that such approaches were positively related to member attachment to the team. Supportive internal leaders show respect for follower ideas, exhibit warmth<sup>91</sup> (Bales, 1950), encourage close interpersonal interactions (Zaccaro et al., 2001) between team members and remove obstacles<sup>92</sup> in nurturing the type of conditions that are conducive to employee emotional health (Ulrich et al., 2008) – i.e. they create "an organisation that is upbeat ..., affirming (Ulrich et al., 2008, p. 100) and an exceptional place of work in the minds of followers.

It is thus argued that a leader should shape the unit's social context (Haslam, Reicher, & Hopkins, 2005) to advance a type of *identity* in support of cohesion (Knouse, 2007), a leadership outcome that is intrinsically linked to and a prerequisite for the formation of a superior value proposition (i.e. EVP) "for the most talented employees who have lots of choices about where they could go work" (Ulrich et al., 2008, p. 114). Ultimately, these views align with those of Steffens, Haslam, Reicher, Platow, Franssen, Yang, Ryan, Jetten, Peters and Boen (2014) who define leadership as nothing more than a process of *social identity management* and as a consequence, leadership effectiveness as the extent to which a special sense of 'us' can be created, shared and embedded within the unit. Incorporating aspects and gleanings from other related theories on values, culture, vision, and shared mental models, the authors (Steffens et al., 2014) outline a process that leaders can follow in developing unit identity outlined in Table 2.10 below that provides additional insights as to the behavioural performance requirements of leaders that want to develop more cohesive teams.

---

<sup>90</sup> Recent studies (e.g. Eckela & Grossman, 2005) have corroborated the premise of a strong identity-cohesion relationship and as such, broach the inclusion of team identity formation as a further critical leadership requirement in the promotion of unit cohesion.

<sup>91</sup> This is tantamount to the "consideration" dimension highlighted by the classic Ohio State leadership studies (Stogdill, 1974; 1948), which referred to the demonstration of warm traits (approachability, concern for follower welfare, etc.) in contrast to a more clinical, performance-orientated 'initiating structure' dimension.

<sup>92</sup> As per the JDR model outlined earlier, it is maintained that leaders can positively affect the intrinsic and extrinsic motivation of followers by removing demands and providing supportive resources in the work environment. Google is a "textbook example" of a company employing such "employee-centric policies and benefits" (Kuntze & Matulich, 2010, p. 2), with the company's employees proudly proclaiming they work for the best company in the world (Murari, 2004).

Table 2.10

*Leadership as a social identity management process*

LEADERSHIP ROLE	BEHAVIOURAL INDICATORS
1. Creating a shared sense of 'us'	Makes people feel as if they are part of the same group Develops an understanding of what membership entails Shapes members' perceptions of group values and ideals
2. Representing a shared sense of 'us'	Embodies what the group stands for Representative of the group Model member of the group Exemplifies what it means to be a member of the group
3. Advancing a shared sense of 'us'	Promotes the interests of the group Acts as champion for the group Acts with group interests at heart
4. Embeds a shared sense of 'us'	Devises activities that bring the group together Arranges events to help the group function effectively Creates structure that are useful for group members

Reprinted from Leadership as social identity management: Introducing the Identity Leadership Inventory (ILI) to assess and validate a four-dimensional model, by Steffens, N.K., Haslam, S.A., Reicher, S.D., Platow, M.J., Fransen, K., Yang, J., Ryan, M., K., Jetten, J., Peters, K., & Boen, F., 2014, *The Leadership Quarterly*, 25, p. 1002. Copyright 2014 by Elsevier.

Zaccaro et al. (2001) highlight the importance of *back-up behaviours* in the team process/performance literature and describe the construct as a collective competency potential variable that entails one or more team members assisting another or other team members to perform their tasks. This "discretionary provision of resources and task-related effort to another... (when) there is recognition by potential backup providers that there is a workload distribution problem in their team" (Ellis et al., 2003, p. 391-392) is important because "if teammates are not looking out for, or willing to help each other out, the team will fail when any one member fails" (Zaccaro et al., 2001, p. 367). As such, back-up behaviours can be regarded as a core component of teamwork (Salas, Sims, Burke, 2005) and a further collective competency potential variable that leaders need to instil and facilitate within a team or unit.

Although back-up behaviours can be spontaneous, Salas et al. (2005) believe that shared mental models, mutual performance monitoring, a high degree of exchange quality in team member relationships, and trust are prerequisites for the type of conduct to manifest itself in teams. Intuitively, this explanation makes sense as it will be difficult for the collective to keep track of the unequal distribution of responsibility or pick up when certain members are temporarily struggling with workload and ensure that all of the team's tasks are completed (Salas et al., 2005) without a shared understanding of the roles of other team members (i.e. the job content associated with the roles of the other members) and faith that others can be called on for assistance in situations in which this is required. However, it is reasonable to argue that back-up behaviours might also be brought about, in part, by individual team members' natural inclination to assist others, a phenomenon that has been categorised as 'altruism' under the broader construct of Organisational Citizenship Behaviour (OCB; Smith, Organ, & Near, 1983). 'Altruism' in this sense, is thought to be kindled by way of *follower actualisation*,<sup>93</sup> which in terms of Maslow's (1971) hierarchical interpretation of motivation, holds that a pyramidal, sequential set

<sup>93</sup> Goldstein (1934) initially introduced the construct and described it as an underlying motive of humans to achieve their potentials and aspirations.

of unsatisfied human needs drive behaviour, and that the highest, most desirable need of the human condition is *selfless self-actualisation*<sup>94</sup>. See Figure 2.13 below.

According to Maslow (1971), higher order needs (i.e. *being* needs such as esteem and actualisation needs) provide the greatest impetus to motivation and grow in intensity when satisfied, while the intensity of the lower-order needs (i.e. the *deficit* needs such as safety and physiological needs) degenerate when satisfied (Warr, 1998), and hence inevitably prompt a shift in focus towards the higher-order needs. Also, while lower-order needs can be satisfied through interpersonal contact or by manipulating objects in the work environment<sup>95</sup> (Armstrong, 2010), the satisfaction of higher-order needs is regulated via internal reactions/feelings of personal fulfilment associated with success, being given responsibility or getting involved in a meaningful duty and thus draws on the more powerful and enduring *intrinsic* domain of motivation. In activating this powerful motivational force, unit leaders are accordingly tasked with the responsibility of developing knowledge<sup>96</sup> of each follower's unique competencies, characteristics and interests (Liden, Wayne, Zhao, & Henderson, 2008), and employing behaviours traditionally reserved only for mentors, such as being an authentic self, receptive non-judgemental listening, encouragement, affirmation (Laub, 1999), and transforming influence (Sendjaya, Sarros, & Santora, 2008) to guide followers firstly to a personally valued state of "inner focus, i.e. differentiation of self, psychological integration or achieving some level of personal potential" (Greene & Burke, 2007, p. 119) necessary to "transcend the ordinary by finding a greater purpose and meaning in their work" (Ulrich et al., 2008, p. 100). Within the context of the leader-follower relationship in a work unit, this tasks leaders with: 1) the systematic matching of different position requirements to the personal competencies of followers/mentees, and moving them into or adapting positions in a way that helps to develop their "bandwidth" (Ulrich et al., 2008, p. 95) in terms of (personally valued) competencies and outcomes; 2) taking a longer-term perspective to map the entire workforce in terms of the key or critical positions that are "wealth-creating" or "critical to the firm's growth" (Ulrich et al., 2008, p. 107); and 3) in passing, identify the people that will be able to perform these roles in the future (or even sourcing the necessary talent<sup>97</sup> from outside the organisation) so as to ensure bench strength in those critical positions that differentiate the organisation in the mind of the customer (Ulrich et al., 2008). Investment in formal training and development interventions conducted off-site or off-the-job represent a further alternative open to leaders that want to engage and retain employees, even if they do not necessarily fall into the category of followers that can fulfil these "wealth creating" or critical positions as part of a more overarching, inclusive talent management approach to retain (Khatri, Gupta, Gulati, & Chauha, 2010) and motivate staff. As such, formal training and development interventions can not only directly enhance job knowledge and competency sets of followers, but also can indirectly improve performance through its effect on employee levels of commitment and engagement (Sharma & Shirsath, 2014) as well.

---

<sup>94</sup> In his book published by his family after his death, *The Further Reaches of Human Nature*, Maslow (1971) revealed a state not included in his initial hierarchy of needs, that he believed to transcend the self in self-actualisation (Greene & Burke, 2007) which he referred to as selfless self-actualisation.

<sup>95</sup> In his famous Two-Factor Theory, Herzberg (1966) termed these 'hygiene factors' (company policy, relationship with peers, work conditions, etc.) that do not lead to higher levels of motivation but simply serve to alleviate job dissatisfaction.

<sup>96</sup> The importance of this leadership competency was also acknowledged in terms of (internal) environmental scanning and consequently recorded under the section on the unit's *strategic subsystem*.

<sup>97</sup> This leadership function is organised under the strategic subsystem where managers are tasked with extracting the necessary resources from the environment.

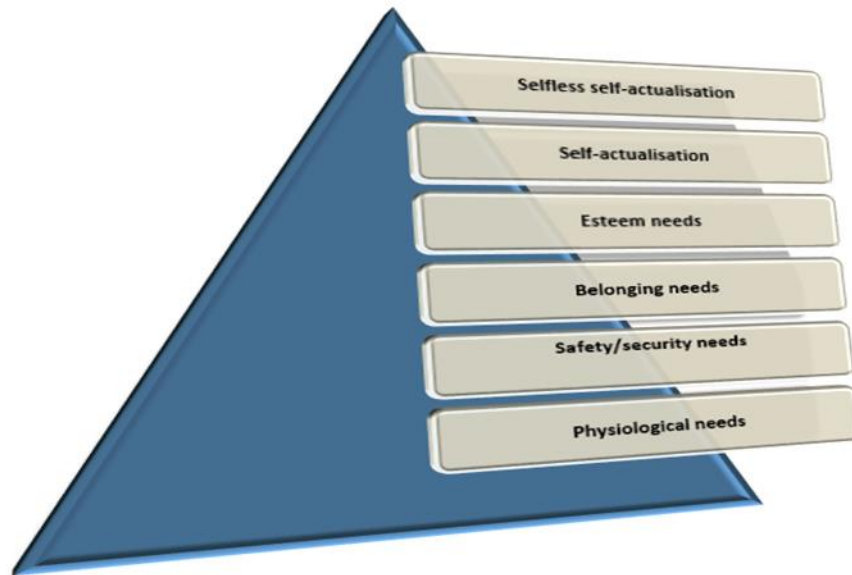

Figure 2.13. Maslow's hierarchy of needs: Six stage version

The psychological state of self-actualisation, in turn, is subsequently also then harnessed in guiding followers to a further, universally valued and final shift towards “the highest level of human nature” (Maslow, 1971, p. 42) – selfless self-actualisation – characterised by a concern for other people, selflessness and altruism (Greene & Burke, 2007). To be able to facilitate this shift in followers, leaders themselves have to have reached this need level. Also, this requires a degree of self-sacrifice in their actions and conduct required to positively transform followers and instil in them the value of servanthood (Bandura, 1986; Greenleaf, 1977), who in turn, are influenced to such an extent that they are likely to exhibit *helping* behaviours (i.e. back-up behaviours) in their dealings with other co-workers (Hu & Liden, 2011) as well. This notion is similar to the previous arguments aired regarding the nurturing of the values of *community* and *caring/support* in the organisation's *strategic subsystem*, the employment of supportive leadership behaviours in the creation of more cohesive teams, and likewise resonates in the principles of social exchange theory which holds that employees are more likely to engage in organisational citizenship behaviours<sup>98</sup> (OCBs) if they themselves are treated with respect and concern (Cho & Johanson, 2008).

*Conflict* involves *divergence* or *divisiveness* (Brown & Kozlowski, 1999, p. 36), and can be described as an affective event (Weiss & Cropanzano, cited in Cummings & Staw, 1996) resulting from an awareness of disagreement (Jehn, 1995) that occurs in organisational (and personal) life as teams start navigating issues such as how to distribute or conduct work, react to social loafing (Wageman, 1995) and deal with deep-rooted differences of opinion and intrapersonal compatibilities among members. Therefore, the existence and escalation of conflict can undermine group cohesiveness, create barriers to collective learning, and strain the relationships required for successful team coordination. Despite the fact that the construct is not yet fully understood (Ayoko, Callan, & Härtel, 2008), most researchers in the subject area have, similarly to those in the cohesion field, condensed all types of conflict into two broad categories: task or relationship conflict (Ayoko et al., 2008; De Dreu & Weingart, 2003; Pelled, Eisenhardt, & Xin, 1999). Task conflict is generally believed to be the more desirable (or even productive) version of the two, and occurs when team members have different opinions/beliefs about their assigned

<sup>98</sup> Although initially conceived from the perspective of individual employee performance, Erhart and Naumann (2004) believe that citizenship behaviours can become a standard mode of behaviour at team level (i.e. becoming a collective competency potential variable) that is fuelled by servant leadership.



tasks, or divergent interpretations of the information related to the group's task requirements (Yang & Mossholder, 2004). This type of conflict is cognitive in nature and is "focused on judgemental differences about how to best achieve common objectives" (Amason, 1996, p. 127). Thus, the assumption under the more classical view is that this type of conflict does not degrade to a personal level and that it simply reflects rather neutral differences of opinion, providing opportunities for members to voice alternative perspectives (Amason, 1996) about the task environment that when resolved, dissolve, having led to greater understanding and integration of all of the immediate issues (Simons, & Peterson 2000) tabled. Accordingly, a certain degree of task conflict has been found on occasion to actually promote team performance (Jehn & Chatman, 2000), decision-making (Amason, 1996), satisfaction with group decisions, and a desire to stay in the group (Amason, 1996; Hoffman & Maier, 1961; Korsgaard, Schweiger, & Sapienza, 1995).

In contrast, the traditional view holds that relationship conflict emanates from fractured personal relationships (Ross & Ross 1989), concerning disagreements about personalities, attitudes, habits, or personal sociocultural norms and values (De Dreu & Weingart, 2003), and is more destructive in nature, particularly when it manifests as deeper interpersonal disagreements that harbour frustration, annoyance, anger, frustration, and hostility (Jehn & Mannix, 2001; Pelled et al., 1999). This *affective* type of conflict is thought to be relatively more enduring, more difficult to resolve, and detrimental to decision consensus and quality (Katz, 1978), as well as levels of cohesion, satisfaction, commitment, and ultimately the performance of the team (Jehn & Chatman, 2000). Despite all of these above reported findings, however, recent contradictory evidence suggests that task and relationship conflict are more coalesced than once thought (Simons & Peterson, 2000) and can both independently have damaging consequences for group functioning (De Dreu & Weingart, 2003). In this regard, extremely high levels of task conflict over a number of case studies have likewise been reported to lead to non-beneficial human subsystem outcomes such as reduced commitment to the team and member satisfaction (Amason, 1996; Amason & Sapienza, 1997). Task conflict duration also appears to result in other negative consequences such as frustration (Peterson, 1999) when the voicing of different opinions leads to group decisions being substantially delayed (Simons & Peterson, 2000). Moreover, evidence suggests that task conflict can actually trigger relationship conflict through employee misattributions of task conflict behaviour (Mishra, cited in Kramer & Tyler, 1996) and that relationship conflict, in turn, can also move into the sphere of cognitive conflict through efforts by one group member to make life difficult for another (Jehn, 1995). It might therefore not be wise for leaders to follow a 'common sense' approach as alluded to in the previous paragraph, in which task conflict is simply encouraged, and relationship conflict is discouraged, as it is a dynamic phenomenon prone to change in intensity and form over time. However, as conflict is largely unavoidable (Thakore, 2013) and generally considered to be detrimental to team cohesion (Wright & Drewery, 2006) and therefore also team performance (Jehn, 1995), a leader has no other option but to manage it when and as it surfaces. In this regard, a number of authors have suggested some strategies aimed at controlling conflict in a more holistic and preventive way. For example, Zaccaro et al. (2001, p. 471) suggest that an important role of team leaders is to moderate the degree of affect in the team by fostering a climate where disagreements about team strategies can be aired constructively.<sup>99</sup>

In highlighting the importance of a related work unit competency potential variable or emergent collective state (De Jong & Elfring, 2010) that can develop over time (Fairholm, 1994), yet can be nurtured through the deployment of the appropriate values in the *strategic subsystem*, Kozlowski

---

<sup>99</sup> This notion is tantamount to N.P. van Wyk Louw's famous description of the 'open conversation (1958) according to which it should be encouraged that members of an in-group can and indeed should be able to talk about anything (even controversial opinions or opposing perspectives) and offer their own personal views under conditions of respect and openness, without such frank, mutual sharing and exchange of opinions being perceived as offensive or leading to the degradation of group relations.

and Bell (cited in Borman, Ilgen & Klimoski, 2003) propose that *interpersonal trust*<sup>100</sup> may also be an important aspect to consider when managing conflict in teams. A culture of trust bonds people (in teams) together (Sonnenberg, 1994) and acts as a “lubricant that reduces friction” (Shea, 1984, p. 2) through voluntary vulnerability (Mayer, Davis, & Schoorman, 1995), openness and honesty, a concern for each other, and beliefs about the reliability of other members’ (Mishra, cited in Kramer & Tyler, 1996) actions and conduct without the ability to monitor or control the actions of another party (Mayer et al., 1995). Further strategies that are at a leader’s disposal to combat divisiveness include the use of team charters or contracts that specify how members should handle challenging situations (Smolek, Hoffman, & Moran, cited in Sundstrom, 1999), the creation of norms to dictate permissible and non-permissible conflict management guidelines (Ayoko et al., 2008; Jehn, 1997), third-party peace-making, the removal, coaching or counselling of troublesome or incompatible members from a team (Barsade & Gibson, 2007; Zaccaro et al., 2001) and the employment of team-building activities during which members share their perceptions of each other and come to understand each other’s point of view more clearly. In light of the foregoing arguments, leaders can then be held responsible for follower psychological health and (selfless) self-actualisation as required for back-up behaviours to become entrenched in the team, for combating divisiveness (i.e. creating interpersonal trust), and facilitating for the team shared mental models, unit efficacy, cohesion, and metacognition. Table 2.11 below provides a detailed summary of the generic leadership competencies that were harvested from the hypothesised leadership responsibilities in support of the achievement of these competency results in the unit’s human subsystem.

---

<sup>100</sup> While vertical trust relationships (i.e. between employees and managers) are paramount, Ferres, Connel and Travaglione (2004) point out that horizontal trust relationships (i.e. between co-workers) are an equally important, yet a much neglected variable of study in the team performance literature.

Table 2.11

*Leadership competencies extracted from the human subsystem*

COMPETENCY	COMPETENCY DESCRIPTION	COMPETENCY	COMPETENCY DESCRIPTION
Raises unit profile	<i>Stands up and fights for the unit; raises the visibility of and gains recognition for the unit.</i>	Entrenches open conversations	<i>Cultivates an environment where members can productively air controversial perspectives and discuss opposing arguments under conditions of openness and respect.</i>
Non-judgmental listening	<i>Authentic respect for followers' feelings, experiences and values even though contrary to personal views. Refrains from criticising or judging followers because of divergent views/beliefs.</i>	Proactive conflict management	<i>Utilises third-party peace-making and mediation techniques to resolve disagreements and divisiveness in the unit.</i>
Leverages formal training opportunities	<i>Develops the bandwidth of followers by matching their growth needs with formal instruction/learning interventions.</i>	Talent management	<i>Integrates member career plans with the unit's succession plan to develop the necessary strategic capabilities in the unit.</i>
Facilitates team planning	<i>Translates unit strategy to facilitate an accurate and shared understanding of the operating environment (i.e. tasks, members, equipment and team) for the unit and how, as a team, followers need to respond.</i>	Facilitates group problem solving	<i>Monitors collective performance episodes, extracts and verbalises the key learning points, encourages, coaches, and shares thought processes underlying effective problem solution and continuous improvement.</i>
Implements quality circles	<i>Deliberately sets time aside for the unit to consider the consequences of strategies, how it considered and arrived at a solution, and how the unit worked together to implement selected solutions.</i>	Elicits follower voice	<i>Encourages followers to speak up when they do not understand and refrains from mocking or ridiculing questions in service of learning.</i>
Models effective work strategies	<i>Demonstrates and models professionalism, punctuality and excellence in the execution of daily tasks.</i>	Team building	<i>Arranges activities, events and opportunities to bring followers together.</i>
Affirmation	<i>Recognises follower potential, communicates faith in them and expresses positive expectations that they will overcome significant developmental challenges in their personal or work lives.</i>	Prioritises quick successes and breakthroughs	<i>Channels unit energy towards the achievement of easier, short-term objectives to affect quick successes on the way to more challenging, longer-term objectives.</i>
Demonstrates positive appraisals of situations	<i>Demonstrates positive appraisal of situations in the form of hope, resilience, and optimism and reassures others that obstacles can be overcome.</i>	Exhortation of excellence	<i>Encourages, expects and backs followers to perform at consistently high levels.</i>
Creates a sense of belonging	<i>Leverages unit vision in creating an exclusive in-group mentality or identity for the unit and makes followers feel part of this group.</i>	Leverages on-the-job training opportunities	<i>Develops the bandwidth of followers by deliberately involving them in different projects or components of the conversion process.</i>
Delivers employee-centric policies and benefits	<i>Cultivates an upbeat and affirming work environment via the provision of resources and the removal of obstacles that matter to followers.</i>	Serves others	<i>Engages in self-sacrificial behaviours aimed at the personal and career growth of followers.</i>

#### 2.6.2.4 THE MANAGERIAL SUBSYSTEM<sup>101</sup>

The preceding discussion provides a comprehensive overview of performance dimensions that highlight the complexities inherent in and the difficulties associated with being an effective leader of a work unit operating in a dynamic environment. Almost overwhelmingly, the discussion points to a wide array of interrelated functions, tasks and responsibilities of leaders who perform a juggling act (Ulrich, Zenger, & Smallwood, 1999) whereby they develop strategic intent, organise unit structure, facilitate resonance between followers and engineer the conversion process for harmonic unit functioning in satisfying all of their stakeholders which include the community, the environment, their followers, and financial investors to name a few. Thus, the “dynamic cognitive and behavioural complexity of the casual chain of mediators and moderators (comprising the intricately interlinked performance@leadership competency model, unit performance@work competency model and an individual employee performance@work competency model) suggest the difficulty in attaining and maintaining leadership effectiveness” (Sanders & Davey, 2011, p. 45). Robert Quinn and his associates (Cameron & Quinn, 2006; Quinn & Cameron, 1983; Quinn & Rohrbaugh, 1983) refer to this ‘juggling act’ as the success with which managers are able to balance the competing demands<sup>102</sup> that coexist simultaneously at any given point in time, in different role-players and at different levels in the organisation. See Figure 2.14 for an overview of their Competing Values Framework (CVF). Thus, “leadership effectiveness is related to what competencies a person uses in different situations and how those competencies get balanced and integrated depending on the situational context” (Hollenbeck, McCall, & Sizler, 2006, p. 404). Moreover, and despite specific external or internal forces impacting the unit which could to a degree, force the leader to prioritise between the pursuit of certain competing and valued unit outcomes by the employment of specific competency sets at any given point in time, Wu and Yu (2009) are of the opinion that different sets of leadership competencies might also have varying degrees of relevance in different stages of an organisation’s life cycle. A quick overview of the Competing Values Framework (Cameron & Quinn, 2006) in conjunction with its relevance on prototypical organisational life cycle stages will suffice to illustrate these dynamics and associated contingencies:

- The Rational goal archetype as typically employed in an organisation’s creation- and growth stages (Tuzzolino & Armandi, 1982) according to which managers focus on the external environment and internal control as *directors* and *producers* of the unit’s longer-term strategic intent and reason for existence. Under such conditions, the leader’s focus would typically gravitate to the development of vision and strategy, the cascading of the strategy and the exhortation of performance.
- The Internal process archetype as typically employed in an organisation’s stabilisation stage (Tuzzolino & Armandi, 1982) that is characterised by increased bureaucracy and according to which managers become internally focused and more control-orientated as *monitors* and *coordinators* of unit internal processes. This could imply the leader’s focus shifting to the implementation and management of a strategic performance monitoring system, coordinating the human and material resources within the unit or re-engineering the conversion process to a more optimal state;
- The Human Relations archetype as typically employed in an organisation’s decline stage (Tuzzolino & Armandi, 1982) according to which managers over time and as part of a ‘clan culture’ become internally focussed on the needs of his/her followers as *facilitators* and *mentors*. By employing such an approach, the leader’s focus shifts to the psychological well-being of employees, follower self-actualisation and development and harmonious unit interactions; and

---

<sup>101</sup> The managerial subsystem (i.e. management/leadership) is tasked with coordinating, adjusting, controlling and directing the other subsystems. The focus falls here on the manner in which leaders should act towards themselves so as to affect the level of competence that they achieve on the competencies derived thus far.

<sup>102</sup> This is why the CVF uses the term *competing* values because the quadrants appear to be in conflict with each other (Lavine, 2014).

- The Open Systems archetype as typically employed in an organisation's dissolution or rebirth stage (Tuzzolino & Armandi, 1982) according to which managers become externally focused on entrepreneurial opportunities in the environment as *innovators* and *brokers*. In following this type of philosophy, the leader's focus would typically shift towards enabling the unit's capability to continuously reinvent itself based on new opportunities in the environment and to lobby, persuade and build business cases for the procurement of resources to pursue these opportunities.

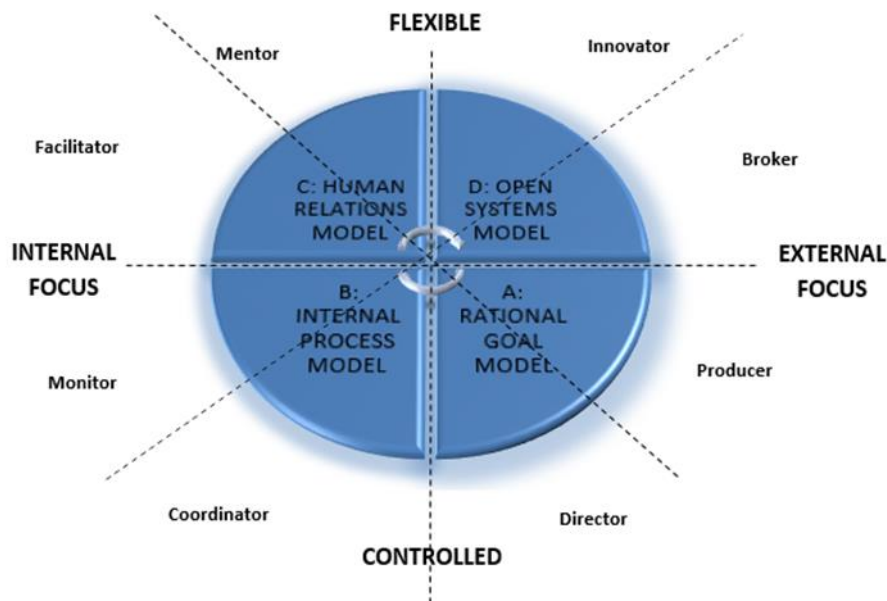

Figure 2.14. The Competing Values Framework.

Reprinted from *Managing complexity via the Competing Values Framework*, by Tong, Y.K., & Arvey R.D. 2015, *Journal of Management Development*, 34(6), p. 664. Copyright 2015 by Emerald Group Publishing.

In working across unit boundaries and by (temporarily) prioritising some unit outcomes over others, leaders therefore find themselves in an environment dominated by interdependence, ambiguity, complexity and uncertainty, which over and above more functional competencies, is likely to require proficiency in a number of personal competencies necessary to fortify and ground the leader in performing their role amidst these dynamic and challenging conditions and expectations. "Personal proficiency is the ultimate rule of leadership" (Ulrich et al., 2008, p. 129) as it serves as the catalyst for the more functional leadership competencies performed in the strategic, structural, technical and human subsystems and equates to the "leader's personal qualifications to lead" (Ulrich et al., 2008, p. 130) others. That is to say that leaders who are not grounded in their values and beliefs, credible through their judgements, emotionally mature through their ability to analyse themselves and connect with others, and that are not willing to learn and grow are more likely to fail or fall flat at critical moments that define their careers. Ulrich et al. (2008, p. 130) believe that such personal proficiency starts with a deeper understanding of the self:

Personal proficiency comes from knowing your predispositions, strengths, and weaknesses. It is about extracting important lessons from your life

experiences<sup>103</sup> and applying them with care, discernment, energy, courage and humanity. It requires equal measures of self-awareness and self-discipline – a certain quality of mindfulness in going about the intertwined business of life and work.

Building on and flowing from self-awareness, additional important leadership behavioural performance requirements crucial to personal proficiency and thus heightened proficiency when dealing with the strategic, structural, technological and human subsystems include core self-esteem (Hogan & Kaiser, 2005), the “handling of stress,” the development of “character, integrity, morality and ethics” (Ulrich et al., 2008, p. 146), being able to demonstrate “personal passion and energy” (Ulrich et al., 2008, p. 149) and “resilience” (Ulrich et al., 2008, p. 147). Success in mastering the leadership role is also thought to rely on inquisitiveness<sup>104</sup> (Jokinen, 2005) or learning agility (Dries, Vantilborgh, & Pepermans, 2012), self-regulation (Sadri, 2012), flexibility (Yukl & Lepsinger, 2004), business acumen, a results orientation coupled with dedication (Dries and Pepermans, 2012) and the proficiency with which he or she can remain in “control of ... emotions when it counts” (Ulrich et al., 2008, p. 141). Other authors add to this long list of behavioural performance requirements by highlighting the importance of *social* and *networking competencies* linked to self-promotion (Dries & Pepermans, 2012) and impression management (Hogan & Kaiser, 2005) that can aid leaders to manage, engage and motivate other people such as by demonstrating personal empathy (Sadri, 2012), being open to others in the world (Levy, Taylor, Boyacigiller, & Beechler, 2007), cultural sensitivity, as well as a talent for building and maintaining relationships (Hogan & Kaiser, 2005) accompanied with excellent communication and writing skills (Hogan & Kaiser, 2005).

Moreover, and consistent with the leadership strataplex previously mentioned, research points to certain *cognitive competencies* that complement and ground leadership success; qualities such as being insightful and displaying certain analytical capabilities (Dries & Pepermans, 2012), effective problem-solving, decision-making under uncertainty, and tolerance for and a special understanding of complexity (Obolensky, 2014) and ambiguity (Hogan & Kaiser, 2005) being the most widely cited examples. Ultimately, and as per the opinion of Ulrich et al. (2008) and other leadership experts, all of these competencies described above contribute to personal effectiveness that attests to a leader’s individual capability, competence and ability/willingness to learn. “Good leaders are competent; they are a contributing resource for their groups” (Hogan & Kaiser, 2005, p. 174) and this display of expertise is necessary to earn a degree of legitimacy and respect from the team they are in charge of (French & Raven, 1959). For the team, the question of whether or not the leader will use, and not abuse, their power (Dries & Pepermans, 2012) therefore becomes paramount as well as the degree of trust the group has in them “not to abuse the privilege of authority” (Hogan & Kaiser, 2005, p. 173). Ultimately, leaders are able to successfully manage others because they have earned the trust, admiration, loyalty and respect (Bass, 1990) from followers through their actions (i.e. through the level of competence that they have achieved on the competencies that constitute leadership), and because of this, followers are willing to follow and work harder (Geib & Swenson, 2013). In short, effective boundary spanners appear to display a level of competence on a mixture of cognitive and personal-social competencies that not everyone can achieve (Sarason & Lorentz, 1998) which are all associated with a well-rounded effective individual, and in turn, is necessary to build follower confidence in the leader and to let him or her lead (Ulrich et al., 2008). In light of the foregoing arguments, leaders then can be held responsible for developing trust in followers that they are capable of leading and guiding the unit to the achievement of challenging objectives. Table 2.12 below

---

<sup>103</sup> At this point, reference should be made to the argument made in section 2.3, where leadership development is conceptualised as a type of an action, rather than an academic learning approach. “Effective leaders do not get stuck in their patterns of leadership. Their leadership evolves as they accumulate experience. They learn from experience rather than simply letting its lessons pass them by” (Sternberg, 2007, p. 36).

<sup>104</sup> Displaying passion, energy, resilience, inquisitiveness, and learning agility are all competencies that are argued to have an additional benefit in facilitating experiential (leadership) learning as well.

provides a detailed summary of the generic leadership competencies that were harvested in support of the achievement of this competency result as pertaining to a leader's role in the unit's managerial subsystem.

### 2.6.2.5 A SUMMARISED INTEGRATION OF LEADERSHIP OUTCOMES AND COMPETENCIES

Grounded in an extensive literature review, the preceding discussion embarked on a 'no-holds barred' explication effort that systematically grappled with each of the subsystems that a work unit comprises of (i.e. the conceptual framework) to extract the important variables relevant to a leader's potential contribution in eliciting unit performance in support of the formulation of a new taxonomy towards this end. The focus of the preceding analysis was therefore the questions as to what has to tangibly and intangibly exist and what needs to tangibly and intangibly occur in the organisational unit for it to serve society over the short and the long term (Slaper & Hall, 2011) and what does the unit leader need to do competently to ensure that these prerequisites are met. As opposed to earlier research aimed at explaining/describing the leadership phenomenon simply from the perspective of traits, styles, the quality of leader-follower relationships or in terms of appropriate behavioural patterns in response to different contingencies (Bass, 1990), this particular exercise assisted in gaining a unique perspective for the development of a 'functional approach' to leadership that unpacks all of the possible variables (i.e. both competency and competency result variables) relevant to leaders' enabling roles as business managers in organisational settings, thus answering the call from a number of authors who have bemoaned the lack of depth in research in this area (Hogg & van Knippenberg, 2003; Howell & Shamir, 2005; and Pawar & Eastman, 1997). In this regard, the use of systems theory provided an apparatus for ensuring the breadth and descriptive accuracy of the extracted behavioural requirements and associated leadership outcomes that addresses the paucity of information (Grant & Osanloo, 2014) inherent to more general, attributional theories on leadership, while at the same time satisfying the general requirements necessary for the development of any (structural) model of human performance by describing clear, precise and (face) valid categories of behavioural acts<sup>105</sup> and their related performance outcomes as specifically pertaining to a generic work unit setting (Goldstein, 1934). Latent variables were firstly identified in each theoretical subsystem that in aggregate, are suggested to be constitutive of the **competency results** expected of leaders in activating or articulating with a sequentially interlinked ('yet-to-be-developed') unit performance@work competency model. A summary of these extracted leadership outcomes is presented in Table 2.13.

---

<sup>105</sup> The validity of the extracted competencies will be subjected to further validity assessment later on in the study via the Delphi method whereby subject matter experts in the field will be consulted as to their views on the importance of these competencies in relation to leadership performance.

Table 2.12

*Leadership competencies extracted from the managerial subsystem*

COMPETENCY	COMPETENCY DESCRIPTION	COMPETENCY	COMPETENCY DESCRIPTION
Displays self-awareness	<i>Regularly conducts deep, honest introspection and seeks feedback on personal strengths and weaknesses, motivations, thought patterns, emotional reactions and goals.</i>	Displays self-esteem	<i>Demonstrates security in personal identity and in responding to devaluation or failures reflecting positive appraisal of competence in various life areas as well as a positive sense of self-worth.</i>
Displays resilience	<i>Displays high levels of energy, drive and perseverance under challenging, adverse conditions. Recovers quickly from setbacks.</i>	Displays business acumen	<i>Applies knowledge and understanding of financial, accounting, marketing and operational functions of the unit and makes good judgements and decisions based on this foundation.</i>
Displays self-regulation	<i>Sensibly applies learning insights to work and personal life.</i>	Displays facilitation	<i>Successfully steers group conversations through impasses towards productive debate outcomes while allowing the group to focus on and control the content of the discussion.</i>
Displays emotional stability	<i>Maintains personal emotional balance under stressful situations without becoming upset, anxious, nervous or angry.</i>	Displays dedication	<i>Remains committed to and passionate about unit success, and takes initiative and accountability over and above what is expected of him/her in the position.</i>
Displays learning agility	<i>Applies sound logic, learns fast and rapidly studies, analyses and understands new situations and business problems to come up with effective solutions.</i>	Displays inquisitiveness	<i>Pursues and creates opportunities to learn and genuinely applies continuous improvement principles. Asks probing questions.</i>
Decision-making under uncertainty	<i>Has a tolerance for dealing with ambiguity and uncertainty and is comfortable to augment facts/figures with personal experiential gut feel to make decisions and seize opportunities.</i>	Displays systems thinking	<i>Handles abstract thinking and sees the broad picture, while others may just focus on its parts. Seeks and connects events in the environment with unit systems and processes.</i>
Displays moral character	<i>Lives by way of a well-developed moral code grounded in honourable decisions and actions.</i>	Displays results orientation	<i>Highly internalised standards of competitive, quality and excellence-driven behaviour.</i>
Communication skills	<i>Writes/speaks in a clear and organised manner for the audience intended.</i>	Flexibility	<i>Adjusts behaviour to changing circumstances or information; remains open to new ways of doing things and experiments with new methods.</i>
Self-promotion	<i>Creates personal visibility and has a desire/ambition to lead. Is comfortable with and seeks power and responsibility.</i>	Influencing and persuading	<i>Conveys impactful messages and gets through to people.</i>
Impression management	<i>Shapes interactions with others in a friendly, engaging manner that reflects their authentic self to leave lasting, favourable impressions.</i>	Displays empathy	<i>Attuned to other people's moods, behaviours and motives even though they might not be able to verbally express these and uses this knowledge to improve the quality of connections with people.</i>
Displays openness to others	<i>Demonstrates a keen interest in and willingness to engage with and explore alternative belief/meaning systems in others.</i>	Displays cultural sensitivity	<i>Learns, acknowledges and respects the cultural differences and -practices that different people bring into unit interactions.</i>



Table 2.13

*Leadership outcomes by way of a systems view of a work unit*

OUTCOME	OUTCOME DESCRIPTION	OUTCOME	OUTCOME DESCRIPTION
Trust in the leader	<i>Admired confidence in the leader to act in the best interests of the group and successfully guide the unit towards challenging objectives</i>	Effective strategy	<i>A communicated and viable, 'investor-friendly' strategy driving the survival of the unit and prosperity in the community in which it operates.</i>
Environmental analytics	<i>Valid and accurate knowledge/data about the unit and the environment in which it operates.</i>	Resource security	<i>The availability of eco-friendly and high quality/sufficient amounts of material resources (i.e. finances, materials, equipment/technology and/or facilities to execute the unit strategy).</i>
Unit psychological health	<i>Fortification/invigoration of psychological resources.</i>	High-performance values	<i>Values reflective of ethical character, environmental awareness, community, achievement, learning and innovation drives behaviours and decision-making of followers in the unit.</i>
Unit cohesion	<i>A shared sense of 'us' and synergistic interactions.</i>	Structural fit	<i>Unit structural configuration enables strategy execution and is optimised in terms of speed, cost-efficiency, product quality and speed of delivery.</i>
Unit metacognition	<i>Collective knowledge structures enabling effective and autonomous identification- and solving of problems.</i>	Shared mental models	<i>An accurate and shared understanding psychologically encoded into the collective mind as to each unit member's role in /expected contribution to team interactions.</i>
Functional information flow	<i>Information/data is readily shared and freely dispersed, upwards, downwards and horizontally.</i>	Interpersonal trust (non-divisiveness)	<i>Positive beliefs about the reliability and authentic intent of (other) unit members.</i>
Unit efficacy	<i>A "can do" mentality and confidence that the unit can meet new, novel and challenging targets/goals.</i>	Psychological unit ownership	<i>Shared accountability/leadership for unit success and buy-in to the leader's vision; demonstrated discretionary effort and entrepreneurial behaviours.</i>
Self-actualisation (back-up behaviours)	<i>Servanthood in followers and the inclination to help others brought about by the satisfaction of their higher order (i.e. affiliation, esteem and fulfilment) growth needs.</i>	Talent	<i>The availability of sufficient quantities of human resources who have the experience, competencies and non-malleable competency potential required to fulfil the operational requirements of the unit.</i>

While the extracted leadership outcomes could be used on face value ‘*as is*’ to constitute the competency results variables of the performance@leadership competency model, the extracted competency variables on the other hand, presented the researcher with some difficulty. The pure high number of competencies eventually extracted necessitated further investigation as to the possibility of the existence of a more parsimonious, second-order competency structure. The large number of first-order competencies that were derived created an almost unsurmountable logistic challenge<sup>106</sup> to collect data on the first-order competencies via a questionnaire and therefore precluded utilising exploratory factor analysis as a technique to identify second-order competencies. The technique of *thematic analysis* was consequently employed to group the first order competencies into *nine* internally consistent behavioural themes (Creswell, 2007), (i.e. second-order competencies) that are believed to represent a powerful taxonomy constitutive of leadership behavioural requirements in organisational settings at a higher level of abstraction. This categorisation process involved the coding of salient features/characteristics across the competency sets extracted from the various subsystems, the collation of these into potential higher order sets, and the ongoing refinement thereof to generate clear definitions and names for each extracted second-order set. (See Table 2.14 below for a more in-depth explanation of the process that was followed).

Table 2.14

PHASE	DESCRIPTION
1. Familiarise yourself with the data	Reading and re-reading the competencies, noting down initial ideas.
2. Generating initial codes	Coding interesting features of the competencies across all subsystems, collating these to specific ‘codes’.
3. Searching for themes	Collating codes into potential themes, gathering all features/characteristics relevant to each potential theme.
4. Reviewing themes	Checking if the themes work in relation to the coded extracts and the competencies required across the entire open system.
5. Defining and naming themes	Ongoing analysis to refine the themes and generating clear definitions and names for each theme.

#### *Phases of thematic analysis*

Reprinted from Teaching thematic analysis: Overcoming challenges and developing strategies for effective learning, by Clarke, V., & Braun, V., 2013, *Psychologist*, 26(2), p. 121. Copyright 2013 by the British Psychological Society.

Analogous to the Big Five personality taxonomy, first-order competencies were therefore utilised as ‘building blocks’ in the development/extraction of several second-order competencies (see Table 2.15 for an in-depth description of the nine second-order competencies) that are suggested to represent leadership behavioural requirements across an entire organisation:

- Analyses and understands the external and internal work unit environment;
- Creates an exciting and aspirational vision for the unit;
- Develops unit competitive ability;
- Entrenches a high-performance culture in the work unit;
- Involves others and elicits participation;
- Unites and connects followers;
- Strengthens and enables followers;
- Manages the internal work unit environment; and
- Displays personal leader proficiency.

<sup>106</sup> It is acknowledged that a planned missingness design (Graham, Taylor, Olchowski, & Cumsille, 2006) offers the possibility of circumventing the challenge presented by a very long questionnaire to individual respondents who are no longer able or willing to provide responses to all items.

Table 2.15

*Second-order leadership competencies*

SECOND-ORDER COMPETENCY	SECOND-ORDER COMPETENCY DESCRIPTION	FIRST-ORDER COMPETENCIES
1 Analyses and understands the external and internal work unit environment	<i>Systematically surveys and immerses the self in the internal and external environment of the unit to collect and interpret information about critical occurrences or conditions on behalf of the unit as input to performance planning.</i>	<i>Internal scanning, external scanning, foresight, strategic monitoring, builds a wide network of contacts, information diffusion.</i>
2 Creates an exciting and aspirational vision for the unit	<i>Attracts and rallies a wide follower base towards an inspiring and exciting future vision of what can be achieved and how their lives can be fulfilled and become more meaningful by joining and investing in such a cause.</i>	<i>Develops an inspiring vision, builds commitment to the cause, attracts others to the cause, unconventional behaviours.</i>
3 Develops unit competitive ability	<i>Develops and secures resources for exploiting viable, eco-friendly and sustainable opportunities necessary for the occupation of a morally superior, winning market position.</i>	<i>Keeps in touch with constituency needs and concerns, entrepreneurial flair, creates business opportunities, explores strategic relationships, explores shared value, conceptualises business strategy, drafts business cases, business process re-engineering, brokers resources, staffing.</i>
4 Entrenches a high-performance culture in the work unit	<i>Consistently behaves and makes decisions in a manner that serves the human condition by eliciting positively valenced psychological functioning in followers.</i>	<i>Demonstrates green behaviours, treats followers with respect, tolerance for mistakes, self-improvement drive, exhortation of excellence, displays authentic intent, application of merit, leverages diversity, emphasises customer service, product/service innovation, serves others and delivers employee-centric policies.</i>
5 Involves others and elicits participation	<i>Provides scope and opportunities for followers to spontaneously contribute their talents/capabilities.</i>	<i>Cascades shared accountability, delegates authority, expands work roles, dismantles bureaucratic constraints, downplays positional power, facilitates participative decision-making, creates channels for follower voice, elicits follower voice, minimises span of control, deploys supportive management.</i>
6 Unites and connects followers	<i>Brings followers together and unites them in fortified, mutually supportive relationships.</i>	<i>Entrenches open conversations, collaborative work structuring, creates a sense of belonging, team building, enhances communication flow, raises unit profile, proactive conflict management, reactive conflict management.</i>
7 Strengthens and enables followers	<i>Raises the confidence and performance capabilities of followers towards success and high levels of achievement.</i>	<i>Facilitates team planning, facilitates team problem-solving, implements quality circles, models effective work strategies, prioritises quick successes and breakthroughs, talent management, leverages on-the-job training opportunities, leverages formal training opportunities, non-judgemental listening, affirmation and demonstrates positive appraisal of situations.</i>
8 Manages the internal work unit environment	<i>Maintains a hands-off procedural view and executes in-process corrections as and when required to ensure that different components of the conversion process keep pulling in the same direction.</i>	<i>Situational updates, balances material resources, balances human resources, manages work sequencing, simulates challenging environments.</i>
9 Displays personal leader proficiency	<i>Functions as a well-rounded, sought-after and high impact resource.</i>	<i>Self-awareness, self-regulation, self-esteem, business acumen, dedication, emotional stability, inquisitiveness, learning agility, systems thinking, decision-making under uncertainty, results-orientation, impression management, empathy, openness to others, flexibility, communication skills, self-promotion, influences and persuades, cultural sensitivity, resilience, moral character, and facilitation.</i>

## 2.7 THE PROPOSED GRADUATE LEADER PERFORMANCE STRUCTURAL MODEL

### 2.7.1 INTRODUCTION

The above analysis provided a powerful and convincing rationale for the justification of the latent competencies and outcomes to be included in a graduate leader *prototype* structural model, in that the purpose and valence of these were described/legitimised in relation to a graduate leader's role in the optimal functioning of any generic organisation. To further explicate the connotative meaning of the South African graduate leader performance construct, the section that follows will discuss each of these extracted latent variables in more detail with reference to the South African context and describe the relationships that are hypothesised<sup>107</sup> to exist between these in illuminating the connotative meaning of the South African graduate leader performance construct. Thus, the instrumentality<sup>108</sup> of the competencies will be indicated in terms of their hypothesised role in the achievement of the latent desired outcomes in addition to the structural interrelationships that are hypothesised to exist between the competencies themselves. The objective of the study is the development of the PGLCQ and the testing of the construct validity of the construct-referenced inferences derived from its dimension scores. In addition to the fitting of the PGLCQ measurement model in a confirmatory factor analysis the construct validation of the PGLCQ would ideally also have included the fitting of the performance structural model that maps the structurally interrelated set of second-order competencies on the set of structurally interrelated latent competency result variables. Doing so would, however, require the development and validation of a Graduate Leader Outcome Questionnaire (GLOQ) in addition to the PGLCQ. Developing and validating both questionnaires, however, was considered an overly ambitious objective. The evidence led on the construct validity of the PGLCQ can nonetheless still be strengthened by fitting the *competency domain* structural model only in addition to the fitting of the PGLCQ measurement model.

#### 2.7.1.1 SECOND-ORDER COMPETENCY: DISPLAYS PERSONAL LEADER PROFICIENCY

The first second-order competency of 'displays personal leader proficiency' was defined as: *functions as a well-rounded, sought-after and high impact resource*.<sup>109</sup> This second-order competency is anchored by a wide array of first-order generic competencies, namely *self-awareness, dedication, emotional stability, learning agility, communication skills, self-regulation, self-esteem, business acumen, inquisitiveness, systems thinking, decision-making under uncertainty, results-orientation, impression management, empathy, openness to others, flexibility, communication skills, self-promotion, influences and persuades, cultural sensitivity, resilience, moral character and facilitation*, all of which were harvested as part of an investigation into the leader's performance requirements in the *managerial subsystem*. As personal proficiency has been positioned previously as the cornerstone of leadership performance (e.g. Hogan & Kaiser,

---

<sup>107</sup> The use of the term *hypothesised* is somewhat contentious. It could be argued that Chapter 2 is aimed at explicating the connotative meaning of the graduate leader performance construct. However, the connotative meaning also lies in part in the internal structure of the construct. A construct is a man-made abstract idea created by the fluid intelligence of man to allow him the possibility of explaining and describing events in World 1 (Babbie & Mouton, 2001). As such, it can be argued that the connotative meaning (and therefore also the internal structure) is in reality actually assigned to the construct. The question whether a specific instrument provides construct valid measures of the construct carrying this specific connotative meaning is then *inter alia* empirically evaluated by testing whether measures derived from the specific instrument corroborate the structural relations that constitute the connotative meaning of the construct. If not, the question arises whether the problem lies with the questionnaire or with specific aspects of the conceptualisation of the construct. Since the latter possibility is undeniably real, the current study regards the use of the term *hypothesised* in the current context as acceptable.

<sup>108</sup> Although the existence of such relationships between the two domains in general would assist in gaining a connotative grasp of the graduate leader performance construct, it should also be noted that latent behavioural performance dimensions could have intrinsic value in terms of its inclusion in the hypothesis without necessarily having a direct bearing on any high-valence outcome that co-exists with them in the nomological network (Myburg, 2013).

<sup>109</sup> In 'leadership strataplex' language, this behavioural performance dimension could be categorised as cognitive and interpersonal competency requirements.

2005; Ulrich et al., 2008) and is believed to qualitatively augment proficiency on the more functional competencies employed by leaders in the other subsystems, direct causal relationships are expected to exist between this competency and five of the second-order competencies (i.e. analyses and understands the external and internal work unit environment, creates an exciting and aspirational vision for the unit, develops unit competitive ability, entrenches a high performance culture in the unit, and manages the internal unit environment) included in the model. Displays personal proficiency is likewise hypothesised to have a causal relationship with the involves others and elicits participation, unites and connects followers, and strengthens and enables followers competencies via the entrenches a high performance culture in the work unit competency that in this case, serves as a mediator variable for the displays personal proficiency competency in the model. Finally, high levels of proficiency in this competency are expected to positively affect the *trust in leadership* outcome variable.<sup>110</sup> A further question to consider is whether trust in the leader feeds back onto the level of competence that is achieved on any of the other eight second-order competencies. If so, the question should in addition be considered whether this latent outcome variable should be hypothesised to exert additive effects to those of the latent variables already in the structural equations (i.e. it exerts a main effect on one or more of the competencies) or rather should be hypothesised to operate as a precondition for the displays leadership proficiency competency to affect one or more of the other eight second-order competencies (i.e. confidence in leadership moderates the effect of displays personal proficiency on one or more of the other second-order competencies). Although the possibility exists that trust in leadership might feed back on one or more of the competencies, the current study would rather want to argue that trust in leadership would more likely moderate the effect of specific competencies on other latent outcome variables (like the effect of creates an exciting and aspirational vision for the unit on psychological unit ownership for example).

### **2.7.1.2 SECOND-ORDER COMPETENCY: ANALYSES AND UNDERSTANDS THE EXTERNAL AND INTERNAL WORK UNIT ENVIRONMENT**

The second-order competency of ‘analyses and understands the internal and external work unit environment’ was defined as: *systematically surveys and immerses the self in the internal and external environment of the unit to collect and interpret information about critical occurrences or conditions on behalf of the unit as input to unit performance planning.*<sup>111</sup> This second-order competency is anchored by the first-order competencies of *internal scanning, external scanning, strategic monitoring, information diffusion and builds a wide network of contacts*, all of which were harvested as part of an investigation into the leader’s performance requirements in a unit’s strategic subsystem. The underlying theme of this second-order competency relates to a leader’s ability to reactively and proactively extract, interpret and disseminate vital *environmental analytics*. The competency therefore denotes behaviours relating to the extraction of and sharing with followers any information/data/insights in a manner that can give the collective entity a competitive edge through adaptive foresight. Viviers, Muller and Du Toit (2005) refer to such powerful and disseminated analytics as *competitive intelligence (CI)*, and argue that the management and sense-making of the overload of available environmental analytics has become a prerequisite for staying competitive in today’s global environment. The authors moreover justify the inclusion of this specific competency in a South African leadership competency model as follows (Viviers et al., 2005, p. 252):

---

<sup>110</sup> It again needs to be stressed that these latent variables constitute latent leadership outcome variables but at the same time also malleable latent work unit competency potential variables. These latent variables should not be confused with latent work unit outcome variables. Ultimately, the relevance of the latent leadership outcome variables (or then the malleable latent work unit competency potential variables) lies in the indirect effect of these latent variables, mediated by a structurally interlinked set of latent work unit competencies, on the latent work unit outcome variables.

<sup>111</sup> In ‘leadership strataplex’ language, this behavioural performance dimension can be categorised as a strategic competency requirement.

The fact that the world is becoming increasingly competitive for South African companies is undisputed (also given the fluctuating exchange rate, the country's geographical proximity and the unique challenges facing South African managers who have to deal with various regulations and legislative matters).<sup>112</sup> How South African managers will meet these challenges is not clear and few seem to develop plans to develop their ability to keep track of competitors and competitiveness.<sup>113</sup> There appears to be a degree of complacency and self-deception that is inhibiting managers from instigating effective planning to improve CI; few conduct CI in a formal and systematic manner. On the positive side, research has shown that managers do recognise a need to better integrate CI in their business processes and strategic planning.

As visioning and the entire strategic management process is predicated and reliant on a deep, penetrating understanding of the environment in relation to the unit's strengths and weaknesses (Petrick & Furr, 1995; Wheelen, Hunger, Hoffman, & Bamford, 2015), the existence of a causal relationship is hypothesised between the analyses and understands the external and internal work unit environment competency and the creates an exciting and aspirational vision and the develops unit capability competencies respectively. For the same reason, this line of reasoning further implies that high proficiency on the analyses and understands the external and internal work unit environment competency should also positively affect the leadership outcome variables of *environmental analytics* and *effective strategy*. The effect of analyses and understands the external and internal work unit environment on both these leadership outcome variables is hypothesised to be mediated by the develops unit capability competency. Finally, as the knowledge diffusion component of the successful employment of this competency denotes the timeous flow of information from the leader downwards to different parties affected by various occurrences and events in the unit's internal and external environment, high proficiency on this competency is furthermore expected to have a causal relationship with the leadership outcome variable of *functional information flow*.<sup>114</sup>

### 2.7.1.3 SECOND-ORDER COMPETENCY: CREATES AN EXCITING AND ASPIRATIONAL VISION FOR THE UNIT

Barring personal leader proficiency, the competency of 'creates an exciting and aspirational vision for the unit'<sup>115</sup> is regarded as arguably the most important variable in the South African graduate leader performance hypothesis as its connotative functionality<sup>116</sup> constitutes a significant component of the developed structural model. This contention, however, should not be surprising given the pervasiveness with which this particular *mystery system* (Herzberg, 1984) as a manifestation of leadership behaviour grounded in their *idealised influence* and *inspirational motivation* (Bass & Bass, 2008) is believed to interweave with the fabric of organisational processes and activities (Elsbach & Sutton, 1992). The competency was defined as: *attracts and rallies a wide follower base towards an inspiring and exciting future vision of what can be achieved and how their lives can be fulfilled and become more meaningful by investing in such a cause*. This

---

<sup>112</sup> Prior research has also shown that developing countries such as South Africa are typically characterised by a high degree of political and/or economic instability (Anastos, Bedos & Seaman, 1980). Such environmental uncertainty (Sawyer, 1993) places additional emphasis on the importance of this competency for leaders in the South African context.

<sup>113</sup> Perhaps such reticence in conducting in proper environmental scanning is a further legacy of the country's Apartheid history, which resulted in a number of imposed sanctions in the early 1990s that could have negated the importance and possibly curtailed the development of this competency amongst (aspiring) business leaders in the country.

<sup>114</sup> More specifically, high proficiency on this competency is expected to augment the top-down component of functional information flow.

<sup>115</sup> In 'leadership strataplex' language, this behavioural performance dimension can be categorised as a strategic competency requirement.

<sup>116</sup> This 'connotative functionality' refers to the relative valence of the competency variable as expressed in the pure number of causal pathways with which it is believed to articulate with the other leadership competencies and outcomes variables.

second-order competency is anchored by the first-order competencies of *develops an inspiring vision, builds commitment to the cause, attracts others to the cause and unconventional behaviours*.

The underlying theme of this second-order competency relates to a leader's ability to attract, energise and create meaning and purpose for people (Nanus, 1992) by gazing "across the horizon of time", and to articulate "the attractive opportunities that are in store when they and their constituents arrive at a distant destination" (Kouzes & Posner, 2010, p. 17). Conceptualised in this way, this competency denotes behaviours leading to the development, expression and sharing of an ideal and valued as of yet unfulfilled future that agents (i.e. staff, suppliers, distributors, investors and free agents) come to internalise because it presents them with a morally superior, aspirational life purpose, an invigorating alternative that is filled with hope and excitement. The building of a shared vision that followers come to hunger for (Pejza, 1985), involves more than the mere articulation of a desired future state but also requires the creation of positive tension (Senge, 2006), for identity transformation (Geib & Swenson, 2013), to occur in aligning with the leader's ideal(s) within (aspiring) followers as well. For this reason, behavioural denotations of this competency also encompass a leader's ability to appeal to (aspiring) followers' inherent human nature that strives for identification with a higher life meaning/purpose, and the leveraging of this appealing proposition of a desired future state as a rhetorical device (Seyranian & Bligh, 2008), through which to persuade (Nye, 2009; Yemm, 2008) and raise their levels of confidence (Berson, Shamir, Avolio, & Popper, 2001) and beliefs that the vision is attainable.

Although the overall outcome of an effective visionary process can be thus described in terms of its overarching *motivational* effect on (aspirant) followers, on closer inspection, the above line of reasoning suggests that visioning can activate at least three underlying and interrelated psychological state formation processes in followers that require further clarification. Firstly, research has pointed to the fact that followers' judgements about the instrumentality of psychologically committing to a leader's cause are influenced by the leader's ability to raise their levels of confidence (Wang & Howell, 2010) that the envisioned 'end-state' is ultimately attainable. In this regard, Rafferty and Griffin (2004) concede that in the absence of encouragement and confidence building efforts, "articulating a vision may have a neutral or even negative influence on employees" (p. 350). Acceptance and internalisation of the leader's cause is accordingly believed to be influenced by the *feasibility* (Markus and Nurius 1986) thereof as well as the leader's ability to create optimism (Berson et al., 2001) for followers, to 'stretch' their ambitions (Gill, 2006) towards this end and engender beliefs that they themselves have "the knowledge, skills and abilities" (Sashkin & Sashkin, 2003, p. 129) necessary to bring the vision to fruition. High proficiency on the competency of 'creates an exciting and aspirational vision' is consequently expected to firstly articulate with the leadership outcome variable of *unit efficacy*.<sup>117</sup>

Secondly and once self-efficacious beliefs are engendered within the unit, the psychological transformation flowing from this that is associated with the internalisation of a leader's vision is characterised by what in general terms can be described as *emotional attachment*, a phenomenon signifying follower acceptance of the leader's transcendental ideals (Fry, 2003). Such emotional attachment (Allen & Meyer, 1990) to or identification (Shamir, 1991) with the leader and their cause is paramount, as in the absence of a critical mass of people that are collectively aligned in purpose, a vision in essence becomes nothing more than an "empty dream" (Nanus, 1992, p. 134). In order to "acquire the force necessary to change an organisation and move it in the intended direction" (Nanus, 1992, p. 134) thus requires the espoused leadership cause to "rest on a moral foundation of legitimate values" (Christie, Barling, & Turner, 2011, p. 2944) that is so alluring and appealing for it to become "self-referential or self-defining for the follower" (Edwards, 2005, p. 215). While this specific effect that visioning can have on followers has been described by other

---

<sup>117</sup> This is not to say that the leadership behaviours underpinning the visioning process are the only contributing factor to the development of unit efficacy. It is rather suggested that such leadership behaviours activate an initial level of confidence in the collective **that can be augmented by other leadership competencies** (specifically **develops unit competitiveness and strengthens and enables followers**) as well as other factors.

researchers in the guise of various other construct labels such as assimilation (O'Connell, Hickerson, & Pillutla, 2011), buy-in (Swales, & Rogers, 1995), ownership (Keyton, 2005) or effective commitment (Kantabutra, 2009), it is suggested that these terms are ultimately all used interchangeably to essentially refer to the same underlying psychological state.

The current study will glean from all of these authors but prefer to label this leadership distillation or outcome variable as *psychological unit ownership*, and consistent with the arguments presented above postulates that high proficiency on this leadership competency has a positive, causal relationship with the development of this psychological state in followers. Perhaps a word of caution is necessary here, as the natural inclination at this point is to assume that it is only the employees in a specific unit that can be influenced and swayed by a leader's transcendental cause. However, a powerful vision that is masterfully disseminated in an environment is not confined to a unit's boundaries and can infiltrate others to influence agents located there in a similar manner as described above. Regardless, as an inspirational, aspirational cause can permeate a number of different systems or suprasystems (including the leader's unit) and become internalised and *owned* by investors, financiers, suppliers and (talented, prospective) employees alike, high proficiency on the competency of creates an exciting and aspirational vision is believed to also have causal relationships with the leadership outcome variables of *resource security* and *talent*.<sup>118</sup>

Riesenmy (2008) and Özdem (2011) allude to a third possible psychological state formation process that is likely to occur in tandem with *unit efficacy* and *psychological unit ownership* by suggesting that an effective vision can serve as a powerful mechanism or stimulant for *group identity building* as well. Hoffman, Bynum, Picollo and Sutton (2011) share this view by asserting that an effective vision can instil in followers a sense of collective pride and the awareness that they are part of something bigger than themselves – a cause that persuades them to give up, for a while, their personal pursuits to follow a common goal (Hogan & Kaiser, 2005) for which they are willing to exert extra effort to facilitate group productivity. Geib and Swenson (2013) and Zaccaro and Lowe (1988) in turn, provide further support for this argument by stating that an effective vision provides the foundation for a shared identity to develop between followers and that shared team goals can facilitate task-based cohesion respectively. Ultimately, this points to the fact that a crowd of people turn into a group when they have something in common to believe in (Freud, 1921) and that a shared (task) identity can develop between followers through the perceived instrumentality of achieving the unit vision for individually held aspirations. The idea that a bond is created from the necessity of unit members to work together to achieve a desired end-state which is unattainable through individual action (Tziner, 1982) aligns with previous descriptions regarding the formation of task cohesion in groups and introduces a hypothesised pathway between the competency of creates an exciting and aspirational vision and a third collective psychological state or leadership outcome variable, namely *unit cohesion*.<sup>119</sup>

A question that should be considered is whether these hypothesised effects of creates an exciting and aspirational vision on *unit efficacy*, *psychological unit ownership* and *unit cohesion* are dependent on one or more prerequisites. Do all visions necessarily translate into these collective psychological states or are specific *provisos* at play? In reflecting on this question, it seems important to again examine the constitutive definition of this second-order competency. In Table 2.15 creates an exciting and aspirational vision is defined as “*attracts and rallies a wide follower base towards an inspiring and exciting future vision of what can be achieved and how their lives can be fulfilled and become more meaningful by investing in such a cause.*” It can be argued that the definition incorporates the *provisos* in that competence on this competency requires that the

---

<sup>118</sup> These outcome variables are not regarded as collective psychological states, but rather as tangible conditions that in tandem with the proper execution of other competencies, leaders can enable for the unit. An effective vision is accordingly believed to inspire agents outside of the leader's system to become part of or invest in the cause as well.

<sup>119</sup> It is not suggested that the successful enactment of this competency can fully account for the development of the cohesion construct but merely that proficiency on this competency can contribute to the development of its task component.



vision must be seen as “*inspiring and exciting*” and achievable. Latent variables that in turn affect these provisos should therefore not be modelled as effects that interact with creates an exciting and aspirational vision (e.g. displays personal proficiency or even a latent work unit outcome variables like *unit production and efficiency* and *unit market standing*) but rather as main effects that affect the level of competence achieved on this second-order competency.

Finally, in addition to the attraction and the rallying of a wide follower base towards an aspirational and exciting cause, Verna (2010) argues that the content of vision statements is important because it guides future behaviours and resource allocation and thus ultimately provides the basis for both strategy and culture creation through its founding definition of the organisation’s ‘ideal future’ or *raison d’être*. Vision articulates what business success means to its constituencies and either explicitly or implicitly, clarifies what products and/or services will be offered and to which markets. A vision moreover captures the leader’s primary transcendental ideal from which the unit’s core values<sup>120</sup> are derived and eventually become embedded in the way that followers respond to problems and challenges. As vision then serves an overarching guiding function and is deemed a precursor to, and even the most important element (Merritt, 2009) in the (more in-depth) strategic planning process of a unit, high proficiency in the competency of creates an exciting and aspirational vision is hypothesised to have a causal relationship with the competency of develops unit competitive ability. As a tool for the dissemination and/or maintenance of organisational culture (Golden, 2009; Nelson & Donnellan, 2009) that sets direction and tone (Hatch, 1993) for it by way of a leader’s core paradigm to guide followers’ actions in moving the unit away from the status quo towards an alternate future (Daft, 1999), high proficiency on this competency is likewise believed to have a causal relationship with the competency of entrenches a high-performance culture.

#### 2.7.1.4 SECOND-ORDER COMPETENCY: DEVELOPS UNIT COMPETITIVENESS

The competency develops unit competitiveness<sup>121</sup> was defined as: *develops and secures resources for exploiting viable, eco-friendly and sustainable opportunities necessary for the occupation of a morally superior, winning market position*. This second-order competency is anchored by the first-order competencies of *staffing, brokers resources, business process re-engineering, drafts business cases, conceptualises business strategy, explores strategic relationships, creates business opportunities, entrepreneurial flair, and keeps in touch with constituency needs and concerns*. The underlying theme of this second-order competency relates to a leader’s competence at developing and shaping a unit’s overall potency in and shared value responsibility to the environment, which will enable it to “outlive any single individual” (Ulrich et al., 2008, p. 16) and sustain its competitiveness in a global, environmentally conscious market. Therefore, the development of unit competitiveness equates to the successful preparation, configuration and strategic positioning of the unit via an effective, societally integrated business strategy, the institutionalisation of feeder channels to secure ongoing and sufficient amounts of green, high quality resources in support of this, and designing a ‘world-class,’ environmentally-friendly conversion process that can meet contemporary customer/community requirements and effectively execute the strategy.

The effective demonstration of this competency is firstly believed to logically feed into/have causal relationships with the leadership outcome variables of *effective strategy, structural fit, talent, and resource security*. That is to say that behaviours as denoted by the first-order competencies of staffing, drafting business cases, brokering resources are expected to positively affect the outcomes of *resource security* and *talent (availability)*; behaviours as denoted by the

---

<sup>120</sup> Although all organisations’ values are to a certain extent unique, it is suggested that unit vision statements (and cultures) should aim to incorporate, allude to or converge towards a minimum standard of high-performance values (i.e. trust and transparency, ethical conduct, fairness, a sense of community and an achievement orientation).

<sup>121</sup> In ‘leadership strataplex’ language, this behavioural performance dimension can be categorised as a business competency requirement.

first-order competency of business process re-engineering are expected to positively affect *structural fit*; and behaviours relating to entrepreneurial flair and the exploration of strategic relationships are expected to positively affect the outcome of *effective strategy*. The extent to which a leader is able to develop the competitiveness of the unit in turn, is further expected to have a positive, causal relationship with the manages the internal work unit environment competency as well as the leadership outcome variables of *shared mental models* and *unit cohesion* respectively. Regarding the relationship hypothesised between the former two competencies, this association is anticipated as it is believed that the existence and availability of an effective strategy, unit structure and quality resources will bolster leadership performance in instances where they are required to intervene and coordinate staff operations in real time. The motivation for the hypothesised pathway between the competency of develops unit competitive ability and the manages the internal work unit environment competency is therefore grounded in the principles of project management, according to which structure (i.e. work/time schedules, action plans, budgets and defined goals) can serve as an effective substitute for management intervention, and unfettered access to resources (i.e. a talented, qualified people, money, materials, technology and infrastructure) in turn, can provide the leader with a number of options with which to offset and counter various forms of (project) scope creep.

More abstract reasoning grounded in the team dynamics literature, on the other hand, motivates the contentions that high proficiency in the develops unit competitiveness competency can serve as a catalyst for both the development of the leadership outcome variables of *unit cohesion* and *shared mental models*. In this regard, unit strategy as one physical manifestation of this competency is believed to be the focal point of reference for the formation of both these constructs of shared meaning (Thompson & Fine, 1999) in groups. With reference to the former, the same arguments that were already aired previously that described how task cohesion can emerge as a result of the necessity of the collective to work together to achieve a desired end-state that is unachievable through individual action (Tziner, 1982) is also applicable here. Accordingly, it is argued that an effective strategy serves a comparable function to vision, in that as a more detailed, in-depth extension thereof, it is expected to (further) fortify bonds between followers under the auspice of shared task identity<sup>122</sup> formation (Zaccaro & Lowe, 1988). Moreover, the fact that a unit's strategy conveys a more precise outlook on the leader's envisaged task and technology allocations and intentions provides the basis for the argument that this leadership artefact can result in the formation of shared mental models in followers as well. Thus, as a more precise blueprint of a leader's vision that elucidates its tangible infrastructure requirements and practical rollout features, a strategy can provide followers with one source of information with which they initially can utilise to inform their *task* and *equipment* domains. When properly informed these domains, of course, are only partly representative of fully functional mental models, with the member and team content domains being notable omissions in this regard. However, the knowledge accumulation processes associated with these domains will be discussed at a later stage and are believed to be brought about or expedited by leadership proficiency in other competency areas.

Finally, while this behavioural performance dimension is proposed as a generic requirement of leaders performing a managerial role in any organisational setting, recent evidence suggests that the improvement of proficiency in this area could be of specific importance to South African business leaders in particular. South Africa's latest ranking in terms of *business sophistication*<sup>123</sup> and the country's constrained economic growth rate was 0.2% from July to September in 2016 (Trading Economics, 2017), which culminated in a decrease of 0.7% in GDP during the first quarter of 2017 (Statistics South Africa, 2017); points to an apparent inability on the side of

---

<sup>122</sup> In other words, high proficiency on this competency is expected to reinforce performance on the creates an exciting and aspirational vision competency in augmenting followers' levels of task cohesion.

<sup>123</sup> South Africa was ranked 50<sup>th</sup> out of 141 participating nations. Business sophistication is measured by two elements that are interrelated: 1) the quality of South African organisations' operations and strategies, and 2) the quality of the overall business network in the country (World Economic Forum, 2019)

business leaders to create value through their organisations' products and services. While this substandard performance can in part be attributed to a number of contributing societal problems unique to South Africa (such as HIV/Aids, the 'brain-drain', skills shortages and unemployment), this erosion of our market position (Kruger, 1995) is also quite likely grounded in a number of suboptimal strategic choices on the side of business (and governmental) leaders who persist with strategic commitments to domestic (rather than global) competitiveness (Department of Trade and Industry, 2016), creating wealth by relying on natural resources instead of knowledge (Roux, 2015), outdated and rigid bureaucratic organisational structures (Shokane, Stanz, & Slabbert, 2004) and low technology content/support and sophistication in the delivery of products/services<sup>124</sup> (Roux, 2015).

### **2.7.1.5 SECOND-ORDER COMPETENCY: ENTRENCHES A HIGH-PERFORMANCE CULTURE IN THE UNIT**

Organisational culture has been defined as a shared set of assumptions about how employees should think, feel and act (Schein, 2004), or as a "unique value system" (Steiner, 1971, p. 121-122) that is representative of and reinforced by the people in a unit and the behaviours they engage in as a consequence of the success with which it has served the collective in the past (Schein, 2004).<sup>125</sup> Although the formation of culture can thus be described in terms of its anthropological nature (Hall, 1969; Tyler, 1971), some authors in support of the functional school of leadership (e.g. Linstead & Grafton-Small, 1992; McCann & Holt, 2009; Schein, 1992) have credited leaders as the primary creators and transformers of culture by way of their visionary guidance (Boomer, 2012; McGowan, & Miller, 2001), but perhaps more importantly, also by 'living' or embodying a unit's culture (House & Podsakoff, cited in Greenberg, 1994). This assumption that a leader's distinctive character (Brown, 1995) and the personal values that a leader holds, articulates and models (Robbins & Sanghi, 2007) will influence the beliefs, behaviours and decisions (McCann & Holt, 2009) of followers in a unit conforms with other authors' descriptions of the construct as a unique type of 'personality' (e.g. Desson & Clouthier, 2010) that emerges in the unit, and even becomes apparent as a characteristic visible to casual outside observers. Analogous to individual personalities then, organisational cultures have been described in terms of their inimitable uniqueness (e.g. Du Toit & Roodt, 2003; Martins, 1989) that can create competitive advantages for organisations (Barney, 1986).

Contentions that all organisational cultures are unique and rooted in differences between leaders' agendas and worldviews have, however, fortunately not constrained research into the investigation of certain *high-performance values* that have universal relevance and utility. For example, Kotter and Heskett (1992) have demonstrated that companies with strong adaptive cultures outperform other companies by significant margins. In their work on *endearing organisations*, Seth, Sisodia and Wolfe (2007) likewise demonstrated that 'caring' type organisations greatly outperformed competitors over a fifteen-year period in terms of investor returns. Preliminary evidence also suggests that individuals (including talented employees and investors) are more attracted to and prefer to work for ethical organisations (Coldwell et al, 2008; Jose & Thibodeaux, 1999) and that ethical and green practices can positively influence company image and reputation, which in turn, can impact long-term firm economic performance through the preservation and strengthening of strategic relationships in the environment (Militaru & Zafir, 2012). Thus, as researchers have established a strong link between companies that display certain universal high-performance values and overall firm financial performance (e.g. Barrett, 2006; Collins & Porras, 1994; Kotter & Heskett, 1992; Seth, Sisodia, & Wolfe, 2007), the second-order competency of entrenches a high-performance culture was deemed a worthy inclusion in a

<sup>124</sup>Graduate development programme interventions targeting the development of this competency should therefore be designed to show young aspiring leaders how to counter these shortcomings amongst other things.

<sup>125</sup> This broaches the idea that feedback loops exist within the larger unit performance@work competency model according to which the effectiveness and efficiency of the unit's production/conversion process and market standing/reputation could feed back into and reinforce the unit's culture.

South African graduate leader competency model as well. This competency was defined as: *consistently behaves and makes decisions in a manner that serves the human condition by eliciting positively valenced psychological functioning in followers.*<sup>126</sup> The competency of entrenches a high-performance culture is anchored by the first-order competencies of *demonstrates green behaviours, treats followers with respect, tolerance for mistakes, self-improvement drive, exhortation of excellence, displays authentic intent, application of merit, leverages diversity, emphasises customer service, products/service innovation, serves others and delivers employee-centric policies.*

As the modelling of the values implied by the first-order competencies listed above is believed to cascade down and eventually become assimilated (Graen & Orris, 1973) and mirrored (Goleman, Boyatzis, & McKee, 2002) by followers in the unit, the competency of entrenches a high-performance culture is firstly expected to have a causal relationship with the leadership outcome variable of *high-performance values*<sup>127</sup> - i.e. the expectation is that leaders will role-model positively valenced values that contribute to an achievement orientation and are conducive to healthy, optimal employee functioning. However, the contention that followers will generally tend to emulate the leader's acts and behaviours (Mat, 2008) also has potentially serious and wide-ranging repercussions, especially in cases where a leader is motivated by self-interest and personal goals rather than altruism and group goals, if their actions are heavily grounded in theory X, or worse still, their management approach gravitates towards the *dark side*.<sup>128</sup> The obvious implication here is that followers will likely start acting and behaving like their leader, and if leaders model *toxicity* via workplace bullying (O'Moore & Lynch, 2007), the creation of power dependency (Sankowski, 1995), "deception and false promises" (Christie, Barling, & Turner, 2007, p. 853), "opportunistic behaviours (Christie et al., 2011, p. 2943) and the like, that the unit will eventually become contaminated and characterised by these scourges itself. As one example of how toxic leadership behaviours have contaminated a place of work in the South African context and left carnage in their wake, it is not hard to imagine the depth of irrevocable damage that PRASA's (the Passenger Rail Agency of South Africa) management team, who have been charged with R4.1 billion in irregular expenditure (Corruption Watch, 2016) and their CEO who is implicated in improper tender procedures, corruption, conflicts of interest and financial mismanagement (Corruption Watch, 2016) have cascaded throughout the parastatal. This example of poor leadership is one of many,<sup>129</sup> and helps to better illustrate the current leadership crisis in the country as well as the need for more ethical, high-performance values to become entrenched in both public and private South African organisations.

The effects of these poor examples of role-modelling notwithstanding, the workplace has essentially become a second, or even the primary home for employees with many spending most of their waking lives there under the scrutiny and at the mercy of their managers, which broaches the further question as to how leadership actions and behaviours can influence followers' overall psychological well-being. It is not implausible that workplace bullying for example, can result in followers consuming their "emotional energy in attempting to safeguard themselves" (Kelloway,

---

<sup>126</sup> In 'leadership strataplex' language, this behavioural performance dimension can therefore be categorised as an interpersonal competency requirement.

<sup>127</sup> Quite remarkably, the Ubuntu values of survival, solidarity, compassion, respect, dignity, sharing, respect and love (Mbigi, 1997) shows significant overlap with 'high-performance' values cited in the organisational behaviour literature, pointing to an unlikely, exploitable convergence point given the divergent natures of the cultures from which both points of view emanate.

<sup>128</sup> Padilla, Hogan and Kaiser (2007) identify five traits as possible characteristics that can influence a leader to fall into 'toxicity' – i.e. charisma, personalised need for power, narcissism, negative life themes, and ideology of hates. Rather than suggesting that these traits have a direct influence on toxic behaviours, the idea is that these traits in combination with a number of circumstances, a specific breeding ground and a special kind of colluding follower could 'transform' these traits into leadership drivers of negativity and destruction.

<sup>129</sup> Other examples include: the gross expenditure scandal of president Jacob Zuma's homestead, the fall of the National Police Commissioner Jackie Selebi that is linked to unlawful dealings with the drug lord Glen Agliotti, the allegations of state capture by the Gupta family, and most recently the Steinhoff saga.

Turner, Barling, & Loughlin, 2012, p. 43) from toxic leaders. Indeed, the idea that a leader can wield such destructive power and influence is corroborated by research indicating that in addition to its effects on follower levels of engagement (Harter, Schmidt, & Hayes, 2002) self-esteem and job satisfaction (Graetz, 1993), poor leadership is also thought to play a part in more serious psychiatric disturbances (Gilbreath & Benson, 2004) in followers such as stress and distress (Tepper, 2000), anxiety, depression and other psychosomatic symptoms (Hoel, Cooper, & Rayner, cited in Cooper & Robertson, 1999).

If read in conjunction with the learnings of the JD-R model described earlier, the qualification is therefore raised that the way a leader interacts with their followers in modelling implicitly held values will in addition to value dispersion and alignment, also impact on employee psychological health in that it will either result in a motivational (e.g. positive behaviours that fortify follower psychological resources) or health impairment process (e.g. negative behaviours representing chronic demands on followers that exhaust resources).<sup>130</sup> Moreover, this unique ‘personality’ that emerges in the unit as a function of how leaders regulate their followers’ psychological resources in combination with cultural artefacts that become entrenched in the unit as a result of this (such as products, technologies, myths and stories) has further implications in that this experience offered by management (Alya, Aned, & Zainal, 2013) ultimately has an effect on its reputation as an employer. In acknowledging the importance of a unit’s EVP in influencing prospective employees’ awareness and perceptions of ‘how we do things around here’, Devaguptapu (2017, p. 37) points to a new “socially networked world”... where “employees share the experience of working with an organisation” with active and passive job seekers alike. Negative messages outbound to prospective job seekers are therefore likely to negatively impact unit EVP, while positive messages, on the other hand, could serve as a talent attraction function.<sup>131</sup> For these reasons, the competency of entrenches a high-performance culture is expected to also have causal relationships with the leadership outcome variables of *psychological health* and *talent*. Finally, as high proficiency on this competency denotes excellence in dealing with and serving the human condition (through such things as fairness, care, respect and self-sacrifice), causal relationships are hypothesised in which the competency of entrenches a high-performance culture positively affects the competencies of unites and connects followers, strengthens and enables followers and involves others and elicits participation competencies respectively.

#### **2.7.1.6 SECOND-ORDER COMPETENCY: INVOLVES OTHERS AND ELICITS PARTICIPATION**

South Africa’s transition from apartheid to a democratic society that extended full human rights (and more specifically access to all job classes and places of work) to all of the citizens within the country has among other things, provided a unique opportunity for businesses and other institutions to tap into the rich potential of the country’s human capital and cultural diversity (Komane, 2014). With a long history of leadership styles and management behaviour heavily influenced by colonial, control-orientated systems (Cook & Nkomo, cited in Luiz, 2006; Jackson, 2004) and apartheid socialisation (Horwitz, Bowmaker-Falconer, & Searll, 1996) resulting in hierarchical, centralised (Jackson, 1999) and generally over-managed organisations (Hofmeyr, 1998), the realisation that such practices inevitably groom non-initiative-taking, disempowered followers (Albertyn, 2001) have fortunately prompted some South African leaders to start experimenting with third- and fourth-wave<sup>132</sup> approaches instead (Maritz, 2002). While this phenomenon can be attributed to the obvious business competitiveness gains that can be derived

<sup>130</sup> After all, the fact that employees leave their bosses and not their jobs is not mere speculation (Harvey, Stoner, Hochwarter & Kacmar, 2007). Moreover, good leaders create a type of work environment that helps followers to avoid burnout and increase their engagement (Shuck & Herd, 2012) and psychological health.

<sup>131</sup> This is not the only way that messages about a unit’s EVP can be communicated. EVPs are typically also communicated via an organisation’s formal career sites and recruitment materials, and more informally, by employees who share stories of their employment experiences with friends and acquaintances at social gatherings outside of work.

<sup>132</sup> Third- and fourth-wave management signals a departure from autocratic, bureaucratic models of standardisation and restraint (Timmers, 1996) towards a more democratic, participatory dispensation enabling increased creativity, innovation and flexibility for change (Maritz, 2002).

from the harnessing of employees' intelligences and creative potentials (Birt, Wallis, & Winternitz, 2004), sensitivity for the country's discriminatory history and the past exclusion of certain groups from decision-making and meaningful participation in our society has also likely expedited, and perhaps even initially triggered this shift in thinking. Nevertheless, as the proper representation and integration of the previously marginalised constitutes a significant challenge that constitutes both a moral obligation and a previously underutilised competitive advantage for South African managers, the second-order competency of involves others and elicits participation<sup>133</sup> was deemed a further worthy inclusion in the development of a South African graduate leadership model as well. This second-order competency was defined as: *provides scope and opportunities for followers to spontaneously contribute their full talents/capabilities* and is anchored by the first-order competencies of *cascades shared accountability, delegates authority, expands work roles, dismantles bureaucratic constraints, downplays positional power, facilitates participative decision-making, creates channels for follower voice, elicits follower voice, minimises span of control and deploys supportive management*.

The underlying theme of this competency relates to the leader's proficiency and comfort with sharing power and delegating responsibility and authority to his or her followers. It also relates to their underlying beliefs (i.e. Theory X and Theory Y) regarding and trust in human nature and the consequent ease with which they will allow independent action given "followers who have shown signs of being responsible and... well motivated in carrying out their duties" (Premeaux & Mondy, 1993, p. 335). Thus, this competency does not denote behaviours giving followers 'free reign' in the unit nor does it equate to the abdication of command; it rather delineates an approach whereby the energies, initiatives and intelligence of employees at all levels are 'spontaneously' extracted by leaders to the benefit of the unit (Nixon, 1994) in line with the followers' inherent human needs for their contributions to be recognised in this way. Accordingly, as followers' *esteem needs*<sup>134</sup> can be nourished through leadership decisions and concessions that liberate them from "denied consideration as individuals ... constant monitoring... arbitrary and capricious discipline ... (and supervision) by petty micromanagers who do not recognise their value as contributors to a common project" (Doughty, 2004, p. 2) and provide them with the means to gain for themselves a sense of approval, competence and status instead, proficiency in the competency of involves others and elicits participation is firstly expected to have a direct positive causal relationship with the leadership outcome variable of *selfless self-actualisation (back-up behaviours)*.<sup>135</sup>

In parallel with this above argument, a similar, yet qualitatively distinctive psychological process is likely to occur when followers are given freedom and discretion to express themselves in their work. Kumar and Ramesh (2014, p. 1241) provide a powerful account of how employees may begin to take ownership within their sphere of influence and '*go the extra mile*' (Fisk & Friesen, 2012) within this context as follows:

Empowering employees leads to organisational encouragement of entrepreneurial traits and prompts employees to make decisions, take action and foster their belief that they can take control of their own destinies. This

---

<sup>133</sup> In 'leadership strataplex' language, this behavioural performance dimension can be categorised as a business competency requirement.

<sup>134</sup> According to Maslow (1971), the satisfaction of higher order esteem needs (i.e. independence and freedom) is a prerequisite for reaching a state of selfless self-actualisation and represents an intrinsic source of motivation in itself.

<sup>135</sup> It is hereby not suggested that high proficiency on this competency is the only determinant of follower self-actualisation (and consequent back-up behaviours in the group) nor that proficiency on this competency can in isolation from other factors, fully account for the journey towards the ultimate end-state of self-fulfilment. It is rather suggested that a number of leadership competencies if properly enacted and adroitly balanced in combination with each other, can collectively contribute to the development of this psychological state in followers) and thus increase the likelihood of back-up behaviours to manifest in the unit.

belief leads to self-motivation and a sense of independence that is translated into greater loyalty and extra effort for the organisation.

The idea then that through involvement and participation employees become invested (Kahn, 1990) in the unit signifies a transformation towards another psychological state and suggests a second expected causal relationship between this leadership competency and the outcome variable of *psychological unit ownership*.<sup>136</sup> This line of reasoning simultaneously broaches the possibility of a structural link between the involves others and elicits participation competency and the manages the internal work unit environment competency, as the management of unit operations is likely to be simplified when in charge of a staff complement that are all already 'entrepreneurially' pulling in the same direction (Kraut, & Streeter, 1995). Thus, it is suggested that the effect of the competency of involves others and elicits participation on the competency of manages the internal work unit environment is likely mediated by the *psychological ownership* outcome variable and that it would become easier for leaders to be competent on the competency of manages the internal work unit environment because competence on the competency of involves others and elicits participation strengthens collective psychological ownership in teams/units. In this regard, the advantages of a workforce that is already looking to maximise profit by eliminating waste, reducing product cycle times (The European Commission, 2000) and is self-motivated to maximise their own productivity levels (Jones, Kalmi, & Kauhanen, 2010) is self-explanatory, especially if compared to an environment where as a result of years of micromanagement and centralised control, management is forced into a position where they are required to be actively involved in planning, correcting and supervising the work of others. Moreover, as the overall quality of a unit's strategic intent is believed to be enhanced through 'spontaneous leaders' at all levels in the unit, who given the opportunity to participate and be involved in the process can provide significant contributions by getting their ideas heard and implemented (Wall & Wall, 1995), high proficiency in the demonstration of the competency of involves others and elicits participation is also expected to improve organisational decision-making capability (Apostolou, 2000) and therefore, to buttress leadership performance in the competency of develops unit competitive ability. Finally, as the underlying process involved in the empowerment of staff in a unit involves the dismantling of formal reporting relationships and the removal of constraining, one-way bureaucratic communication channels, the competency of involves others and elicits participation is also predicted to have a causal relationship with the leadership outcome variable of *functional information flow*.<sup>137</sup>

### 2.7.1.7 SECOND-ORDER COMPETENCY: UNITES AND CONNECTS FOLLOWERS

Members of a unit may experience *psychological ownership*, *health* and have *confidence* in the unit's management but be completely detached from one another on a personal, associative level and vice versa. Even in cases where task-driven interdependencies do exist or are imposed, and individual members may conscientiously (albeit begrudgingly) meet the interaction requirements set for them in this regard, divisiveness and the absence of attraction to or a 'bond' with the group could still cripple overall team functioning. Worse still, adversarial relations can actually develop between (key) members of personnel that, for obvious reasons, can be even more detrimental to team dynamics and performance. At this point specific reference should be made to previous arguments already aired describing how relationship conflict could actually ignite or shift divisiveness to the task environment, whereby parties with affective incompatibilities characterised by tension, animosity and/or annoyance (Carter, Fiore, & Asencio, 2015) come to utilise ingratiating tactics in trying to purposefully make work life difficult for other unit members (Jehn, 1995). This moves the discussion on leadership performance

---

<sup>136</sup>High proficiency in this competency is expected to augment followers' initial attachment to the leader's cause (i.e. vision and strategy) by activating an additional dimension of ownership – a level of power and control over how they choose to interpret and work towards the cause in their daily work lives.

<sup>137</sup> More specifically, high proficiency on this competency is expected to augment the bottom-up component of functional information flow.

requirements away from vertical (i.e. leader-follower) relationships and task cohesion, towards horizontal relationships (i.e. between followers) and social cohesion, where factors influencing team functioning such as composition, size, heterogeneity and tenure (Kozlowski & Bell, cited in Borman, Ilgen, & Klimoski, 2003) become key considerations.

While team composition, size and tenure continue to draw the attention of team dynamics scholars, member heterogeneity has perhaps surpassed these factors in terms of a research priority given the new realities of a globalised world. In South Africa in particular, team member heterogeneity is extremely relevant given the country's discriminatory past and the restitutionary measures that are currently in operation because of this. As opposed to the discriminatory and homogeneous Apartheid work model implemented prior to 1994, the South African workplace of today has been described as a "complex kaleidoscope" filled with not only "ethnic, racial and tribal distinctions"<sup>138</sup> (Shonhiwa, 2006, p.8) but also other, deeper level member cosmopolitan differences such as religion, values, attitudes, level of education, functional knowledge and beliefs (Harrison, Price, & Bell, 1998; Jarzabkowski & Searle, 2004; Jehn & Bezrukova, 2010; Mannix & Neale, 2005). While these differences do offer opportunities in terms of learning, cross-pollination and even reconciliation, at the same time, they may also cause conflict resulting from diversity challenges<sup>139</sup> (Jehn & Bezrukova, 2010; Klein, Knight, Ziegert, Limi, & Saltz, 2011) that can arise throughout the course of everyday work-life as teams pursue collective goals. Moreover, the ageing workforce (i.e. Gen X) has created the need for multiple generations to be able to work in harmony towards company success (Chao & Moon, 2005; Twenge, 2010), thereby further complicating the role of managers in pre-empting conflict and evoking, rather than constraining or leaving to chance, synergies that can produce team performance gains (Hackman, cited in Lorsch, 1987). For these reasons, the second-order competency of unites and connects followers<sup>140</sup> was deemed a further worthy inclusion in the South African graduate leadership model. The competency was defined as: *brings followers together and unites them in fortified, mutually supportive relationships*. This second-order competency is anchored by the first-order competencies of *entrenches open conversations, collaborative work structuring, creates a sense of belonging, team building, enhances communication flow, raises unit profile, proactive conflict management, and reactive conflict management*. The underlying theme of this competency relates to the leader's proficiency in bringing followers together – facilitating authentic, close and open relationships between staff, creating and fortifying a unique identity for the unit, 'smoothing over' destructive forms of conflict that may arise as members work towards shared goals, and promoting cooperation and trust amongst a group of (culturally) diverse followers. Although in the South African context this may prove to be particularly difficult given the country's past, the ambitious goal remains for leaders to be able to channel cultural nuances and other sources of divisiveness into a constructive direction (Shonhiwa, 2006), facilitate a sense of belongingness for all, build bridges and friendships, and ultimately extract the collective potential of followers as manifested in their interactions, bonds and behaviours at work. Accordingly, this competency denotes behaviours that allow leaders to become "social architects of their organisation(s), taking special effort to develop relationships and purpose among their followers" (Hughes, 2014, p. 7).

Consistent with the structure of the exposition of the second-order leadership competencies thus far, high proficiency in the uniting and connecting others competency is also expected to result in or contribute to a number of leadership distillations, some of which have been touched on previously. Firstly, as numerous social psychological studies have shown that shared activities

---

<sup>138</sup> In fact, South Africa is often referred to as the *Rainbow nation* and is believed to have one of the most complex and diverse populations in the world.

<sup>139</sup> This is not to say that the current study regards diversity in a negative light. While team diversity can increase the possibility of potential conflict (Garcia-Prieto, Bellard, & Schneider, 2003) in a team, it is also acknowledged that it can elevate levels of creativity and innovation (Morgan, 1989) adaptability and problem solving (Mazur, 2010) as well.

<sup>140</sup> In 'leadership strataplex' language, this behavioural performance dimension can be categorised as a business competency requirement.



and direct interactions during the course of everyday life can catalyse meaningful human relationships in social groups which people belong to (DeLamater & Myers, 2007), high proficiency on the competency of unites and connects followers is expected to contribute to the satisfaction of followers' innate human desire for forming and maintaining social bonds<sup>141</sup> (Baumeister & Leary, 1995), and thus, to have a positive, causal relationship firstly with the leadership outcome variable of *selfless self-actualisation (and back-up behaviours at a team level)*. This line of reasoning is not meant to imply that the satisfaction of the psychological needs of *belonging* (Maslow, 1971) will automatically evolve followers towards Maslow's (1971) ultimate state of self-actualisation, nor that it is only leaders that can facilitate the development of this psychological state between followers through their actions alone.<sup>142</sup> It is rather suggested that in combination with other conditions being met, such as the satisfaction of follower *esteem needs* and *self-fulfilment needs*, high proficiency on this competency represents a further contributing force within the overall motivational journey and process.

Secondly, the formation of deeper social bonds between followers in the unit presupposes that members become familiar with and grow fonder of one another, resulting in an increase in exchanges of social-emotional information, which ultimately serves to bind them at the socio-emotional level (Lu, 2015) supplementary to their formal team assignment (Foster, 2004). This bonding process that typically evolves naturally, but can nonetheless be facilitated by leaders especially in an immature team, is therefore likely to foster deeper familiarity with each other, an understanding that is anticipated to expedite the development of shared mental models. The knowledge accumulation referred to here, however, is not suggested to inform the same content domains of followers as described earlier in the exposition. Thus, whereas in the discussion on leadership proficiency on the competency of develops unit competitive ability it was argued that leaders can expedite the formation of shared mental models via followers' accumulation of information pertinent to task and equipment domains, it is expected that within this context, leadership performance (as manifested through the development of deep social relationships between followers) will result in the accumulation of information pertinent to followers' *member* content domains. A second hypothesised relationship is therefore predicted between the competency of unites and connects followers and the outcome variable of *shared mental models*.

This type of bonding and knowledge exchange, at the same time, elicits strong associations with the construct of *social cohesion* as discussed earlier in this chapter, and introduces a third hypothesised relationship between the competency of unites and connects followers and the leadership outcome variable of *unit cohesion*.<sup>143</sup> The contention is therefore made that in addition to getting to know each other's habits, routines, expertise, skills, etc., high proficiency on the competency of unites and connects followers can affect a state whereby followers become increasingly reliant on other members for gratifying their social psychological needs, which in turn, could result in more positive attraction to the social entity and its members (Sánchez & Yurrebaso, 2009). In contrast to group cohesion derived from shared value or goal commitment, this type of adhesiveness and communal interaction (Clark & Mills, 1979) characterised by increased responsiveness to each other's personal needs and general welfare is thus expected to originate from varying levels of friendship that intensify over time. Such a collective psychological state of social cohesion is, however, likely to only be fully realised at a more advanced developmental team stage (Tuckman & Jensen, 1977), after members have had sufficient interaction time and opportunities to get to know each other intimately, and leaders have

---

<sup>141</sup> Maslow (1971) interprets these as belonging needs – social connections and relationships without which people cannot grow toward self-fulfillment.

<sup>142</sup> It must be acknowledged that relationships can form between unit members as a natural occurrence without any form of leadership intervention.

<sup>143</sup> More specifically, high proficiency on this competency is expected to augment the social component of the team cohesion construct.

implemented a number of interventions at team level towards this end (Clark, Mills, & Corcoran, 1989).

Nonetheless and whilst representative of an important leadership outcome that is beneficial to group functioning in its own right, the existence of high levels of social cohesion is often also associated with other positive outcomes that can manifest in groups at a collective level of analysis. In this regard and as alluded to in the discussion on team member mental model convergence, unit social cohesion is believed to regulate both the amount and quality of interaction that occurs among unit members (Lu, 2015). Accordingly, a communicative feature is expected to emerge in cohesive groups in terms of both the frequency (Moran, 1966) and quality of the communication exchanges between unit members – i.e. members of highly cohesive groups tend to communicate more with one another than members of non-cohesive groups, and such interactions are typically friendlier, accommodating and involve more attempts to reach agreement (Shaw & Shaw, 1962). Secondly and related to increased levels of intimacy or authenticity in communications (Jarvenpaa & Leidner, 1999), perhaps a more important possible upshot of social cohesion is the advancement of trust between unit members (Lu, 2015). In this regard, it has been suggested that sustained personal contact such as is characterised by teams at a more advanced stage of cohesion decreases the likelihood of inter-group conflict (Amir, cited in Katz, 1976) because cognitive judgements of another member's motives and intentions (Simons & Peterson, 2000) will be more positively construed if associated with prior behaviours and experiences (Lewis & Weigert, 1985) grounded in solidarity, mutual support and intimate (Lewin, cited in Cartwright, 1943) and enduring friendships (Cooley, 1909). Ultimately, as high proficiency on the competency of unites and connects followers is then believed to allow team communication to grow and thrive and facilitate productive (and trusting) information exchanges and sharing, positive, causal relationships are expected between this competency and both the leadership outcome variables of *functional information flow*<sup>144</sup> and *interpersonal trust*.<sup>145</sup> Thus, the effect of the competency unites and connects followers on the outcome variables of *functional information flow* and *interpersonal trust* is likely mediated by the outcome variable of *unit cohesion* – i.e. in more cohesive teams the flow of communication and the development of trust is hypothesised to be expedited. Finally, as the existence of cohesion, functional communication flow and trust is believed to produce synergistic gains in group functioning and consequently, can reduce the need for 'hands-on' management intervention and conflict resolution, high proficiency on this competency is also expected to buttress leadership performance on the competency of manages the internal work unit environment.

### 2.7.1.8 SECOND-ORDER COMPETENCY: STRENGTHENS AND ENABLES FOLLOWERS

One of the major barriers to South Africa's economic growth prospects post-democracy remains the persistent skills and human capital shortages that exist in the country's labour market. The Apartheid government that was dismantled in 1994, can again be greatly blamed for this state of affairs, in that its enacted policies of racial segregation (e.g. the Group Areas Act of 1950, the Native Laws Amendment Act 54 of 1952, the Bantu Education Act 47 of 1953, etc.) at the time institutionalised restricted access to education, training, job experience and meaningful societal participation for certain demographic groups in the country. These actions skewed the natural growth trajectory and systematically deprived what was in fact by far the largest part of the population of developmental opportunities with which they could have advanced their own

---

<sup>144</sup> The successful enactment of this competency is expected to augment the *horizontal* component of functional informational flow.

<sup>145</sup> As is the case with most emergent collective states, cohesion and trust within a unit can simultaneously influence and be a product of team interactions and processes. That is to say that authentic interactions between certain members in a team can advance trust, whilst high levels of trust can influence team interactions for the better (Chen, Sheng, & Tian, 2010) as well.

human capital<sup>146</sup> – the professional – and life knowledge and skills coupled with self-esteem, confidence and drive that are so crucially required to propel the country forward today. Other factors post-democracy have moreover compounded scarcities in qualified and/or experienced manpower, immigration (i.e. the ‘brain drain’), HIV and AIDS (Tshilongamulenzhe, 2015) and the persistent inability of the country’s education system to generate the skills necessary for the country’s economy to thrive (Mateus, Allen-Ile, & Iwu, 2014) being the most cited reasons in this regard. Ultimately, and despite a number of well-intentioned governmental interventions (such as Skills Levies, SETA’s, National Skills Development Strategies, Black Economic Empowerment and Affirmative Action) targeting skills development and the widening of the country’s employment base, persistent human capital shortages have resulted in a situation whereby South Africa is currently ranked one-hundred-and-seventh out of 141 countries for the quality of its future workforce skills (World Economic Forum, 2019)

Given these realities and the fact that businesses are one of the main benefactors of a high-quality workforce that stand to lose out if the situation remains unchanged, it follows that South African organisations should stop viewing human capital development as the exclusive purview of the government and become more actively involved. This challenge is directed at organisational leaders, urging them to redefine the firm’s role in society by accepting partial ownership for the transformation of the country’s human capital, not only because of the obvious business competitiveness gains and societal improvements that can be affected through such actions, but also because of moral reparations owed to the peoples of the designated groups and their descendants who have endured numerous hardships under the euphemistically named ‘separate development’ of the past. While thus an important business priority in its own right in this country specifically, the addition of the work of developing people to the leadership agenda can also be justified on more universal grounds. This line of reasoning should be interpreted within the context of a larger war for talent that continues to intensify (Fernandez-Araoz et al., 2011; Beechler & Woodward, 2009) world-wide, although recently more so through generative approaches to create talent internally rather than simply “buying” star performers (Beechler & Woodward, 2009) from other countries, markets or organisations.<sup>147</sup> Thus, as an important skill-set that is required for the development of followers for the benefit of the unit and society as a whole and the building of internal capacity with which to offset talent shortages in the South African labour market, the competency of strengthens and enables others was deemed a further critical addition to the South African graduate leader performance model.

The second-order competency of strengthens and enables followers<sup>148</sup> was defined as: *raises the confidence and performance capabilities of followers towards success and high levels of achievement.* This competency is anchored by the first-order competencies of *facilitates team planning, facilitates team problem-solving, implements quality circles, models effective work strategies, talent management, prioritises quick successes and breakthroughs, leverages on-the-job training opportunities, leverages formal training opportunities, demonstrates positive appraisal of situations, non-judgemental listening and affirmation.* The underlying theme of this competency relates to a leader’s willingness and ability to serve others and develop talent/potential by meeting the developmental needs of both individual members as well as those of the team as a whole, and fortifying beliefs in the unit that the collective entity is capable of achieving “extraordinary heights” (Boal & Bryson as cited in Baliga, Dachler, Hunt, & Schriesheim, 1988, p. 11) and can overcome challenging operational obstacles, even under diverse conditions. This competency ties in with the contemporary practice of talent management and denotes

---

<sup>146</sup> Human capital refers to not only knowledge and skills acquired through schooling and tertiary education, but more broadly to the competencies and competency potential required for self-sufficiency and – improvement in all spheres of life, i.e. relationships, family, children, occupation, citizenship, etc.

<sup>147</sup> This type of approach has proven to be quite ineffective in South Africa as well; particular in securing the services of *Black diamonds* who tend to be headhunted and job-hop for attraction premiums (Ratuva, 2013).

<sup>148</sup> In ‘leadership strataplex’ language, this behavioural performance dimension can be categorised as a business competency requirement.

behaviours targeting proactive competency, competency potential and career development as well as the development of rare, valuable and difficult to imitate team capabilities. The behaviours denoted here moreover overlap with mentoring and coaching leadership applications as referred to earlier in this chapter, the latter targeting performance at a team level and the former targeting performance improvement at an individual level of analysis.

The mentoring component of this competency covers the same types of behaviours that Bass (1985) categorised under the *individualised consideration* competency of his transformational leadership theory. Individualised consideration occurs when a leader identifies and takes into account each individual unit member's unique 'starting block' as input to development planning while at the same time, coming to grips with the motivational needs and undertones of each member. The discovery of the needs, capacities and potentials of all unit members' inner beings (Rogers, 1961) also assumes familiarity with followers, enhanced communication and increased or improved psychosocial information exchanges such as are typically characterised by successful career-orientated mentor-mentee relationships (Kram, 1983). The actual developmental orientation of the mentoring component of this competency comes to the fore after a growth path has formally been agreed to, allowing leaders to affirm and role-model the 'right' behaviours, provide career advice, observe and record progress, and make resources available for and encourage followers to attend training courses in support of the established developmental goals (Bass, 1985). Individual development goals are moreover set within the context of a broader talent management strategy requiring leaders to: 1) systematically match different position requirements to the personal competencies of followers/mentees, and moving them into or adapting positions in a way that helps to develop their "bandwidth" (Ulrich et al., 2008, p. 95) in terms of (personally valued) competencies and outcomes; 2) taking a longer-term perspective to map the entire workforce in terms of the key or critical positions that are "wealth-creating" or "critical to the firm's growth" (Ulrich et al., 2008, p. 107); and 3) in passing identify the people that will be able to perform these roles in the future so as to ensure bench strength in those critical positions that differentiate the organisation in the mind of the customer (Ulrich et al., 2008). Hence, in followers' pursuit of the full expression and realisation of their personal performance potential at work, leaders contribute by way of customised emotional, informational, instrumental and appraisal support (House, 1981) in accordance with the unit's longer-term succession plans.

It follows that the successful guidance of followers through this process of exploration and a series of stretching assignments can advance a sense of personal growth, fulfilment and security in unit members, which motivates the hypothesised relationship between the competency of strengthens and enables followers and both the leadership outcome variables of *selfless self-actualisation (leading to back-up behaviours at the collective level)* and *talent*. The latter hypothesised relationship is expected as "the obvious and most discussed benefits" of mentoring after all, "are those related to the development of human resources" (Wilson & Elman, 1990, p. 88). High proficiency on this competency is accordingly expected to develop follower human capital, bench strength in critical positions that differentiate the unit from others in the mind of the customer, and therefore to enhance the overall talent pool of the unit. The former relationship, on the other hand, is anticipated in line with Maslow's (1971) argument that *self-fulfilment* needs represent a fundamental and probably the most powerful motivating force for all people. In view of this, a relationship between high proficiency on this competency and the outcome variable of *selfless self-actualisation (back-up behaviours)*<sup>149</sup> is anticipated on the basis that effective leadership in this area can provide the stimulus required for followers to transcend to what

---

<sup>149</sup> Once again, it is not hereby suggested that high proficiency on this competency is the only determinant of follower self-actualisation (and consequent back-up behaviours) nor that proficiency on this competency can in isolation from other factors, fully account for the journey towards the ultimate end-state of self-fulfilment. It is rather suggested that a number of leadership competencies if properly enacted and adroitly balanced in combination with each other, can collectively contribute to the development of this psychological state in followers and thus increase the likelihood of back-up behaviours in the unit.

Maslow (1961) refers to as a peak experience or the summit of their personal potential within the unit.

Breakthroughs of this magnitude cannot be separated from the evolution of confidence in followers that can grow concomitantly with the accomplishments associated with successful mentor-mentee relationships. Indeed, a central idea posited in social cognitive theory is that success and achievements can raise personal levels of self-efficacy, which in turn, has positive implications for future attempts at performance within a specific task domain that can even generalise to new situations (Bandura, 1977). Similar, then, to the psychological state of trust that can be interpreted as both an outcome of and input to social cohesion in groups, self-efficacy can likewise result in a positive snowball effect of achievements and personal growth in individual members if properly channelled by leaders across various assignments of increasing complexity and difficulty. Maybe more importantly, Bandura (1997) makes it clear that as an extension of personal self-efficacy, shared efficacy can also emerge at a team level to regulate members' beliefs about the performance potential of the entity as a whole that has "similar sources, serves similar functions, and operates through similar processes" (p. 478) than the individual self-efficacy construct. Although a leader's *individualised consideration* for followers still likely serves as the primary source for these efficacy beliefs, the actual development of collective efficacy does "not occur during self-efficacy formation or when members form individual beliefs about their group" (Gibson, 1999, p. 138) and it is therefore the position of the current study that leaders can build on these positive beliefs engendered in individual followers by leveraging coaching strategies at a team level to augment shared perceptions regarding "the performance capability of a social system as a whole" as well (Bandura, 1997, p. 478). For example, as a track record of past achievements and performance can regulate an individual's self-efficacious beliefs, it is believed that leader-facilitated breakthroughs at a team level can also make the collective entity feel strong, capable and start believing that together they can do more than they ever thought was possible (Kouzes & Posner, 2010). Thus, as more successes are attributed to collective competence (a "we can do it mentality"), "this serves to increase self-efficacy among leaders and followers alike" (Hodgkinson & Sparrow, 2006, p. 14). Alternatively, such transfers can occur through emotional contagion whereby the hope, optimism and resilience (Luthans & Youssef, 2007) displayed by the leader can 'rub off' on followers (O'Neil, Harrison, Cleveland, Almeida, Stawski, & Crouter, 2009) or by the encouragement and exhortation of excellence (Zaccaro et al., 2001) that influence the team's beliefs that they can overcome challenging assignments together. For these reasons, high proficiency on the competency of strengthens and enables followers is expected to articulate with the leadership outcome variable of *unit efficacy*<sup>150</sup> as well.

This notwithstanding, coaching strategies as employed by leaders at a collective level of analysis can have further benefits for the upliftment and strengthening of teams. More specifically, earlier in the chapter the views of Cannon and Edmondson (2001) and Kozlowski et al., (cited in Ferris, 1996) were held to be significant in terms of ex post-facto interventions that can be employed by leaders to verbalise learning points and coach the team on problem identification, fact-finding and effective solution generation. Occurring at the conclusion of projects and assignments, these interventions do not target efficacy beliefs directly, but rather the actual cognitive structures of the team through a type of action learning approach whereby consideration is given to the way that the team constructed problems, "evaluated possible solutions, and implemented the selected solutions" (Zaccaro et al., 2001, p. 460). It is this conscious exploration of team cognitive functioning that allows new knowledge to be integrated into existing team processes that are

---

<sup>150</sup> This argument ties in with the discussion on the visioning process where leadership competence in this area was hypothesised to raise follower confidence and beliefs that a vision is ultimately attainable. In contrast, however, the effect that high proficiency on the strengthens and enables **others** competency can have on self-efficacious beliefs in followers is thought to operate at a lower level of abstraction whereby leaders impact the team's *task-related self-esteem* and beliefs pertaining to their *general efficacy* at work.

either retained or modified as a result of the extent with which this learning has caused improvement in consequent performance cycles. Accordingly, “a relatively permanent change in the team’s collective level of knowledge” (Ellis et al., 2003, p. 822) can occur through the collective’s shared experience and the leader’s ability to *intellectually stimulate* (Bass, 1985) the manner in which the collective interprets this reflectively through the encouragement of different perspectives, non-traditional thinking and suggesting other ways to complete future assignments. As high proficiency on the competency of strengthens and enables followers also encompasses behaviours relating to the improvement of team planning, problem solving and the provision of structures for reflection on the consequences of team strategies, leadership performance in the area of team coaching is therefore also believed to have a positive, causal relationship with a fourth leadership outcome variable, namely *unit metacognition*. Finally, as the existence of *metacognition* and *collective efficacy* provide competitive advantages for overall team functioning, high proficiency on the competency of strengthens and enables followers is lastly expected to have a positive, causal relationship with the competency of manages the internal work unit environment. This relationship is expected as the existence of *metacognition* and *collective efficacy* is hypothesised to mediate the effect of the competency strengthens and enables followers on the competency of manages the internal work unit environment. These mediating relationships are anticipated as a more resourceful team that is already looking to set more challenging targets (Katz-Navon & Erez, 2004), are less vulnerable to failures (Bandura, 1997) and that has the capacity to self-reflect on and learn from the procedures, tactics and habits by which they pursue their objectives is likely to reduce the need for management intervention, and thus, to buttress leadership performance in the competency of manages the internal work unit environment.

#### **2.7.1.9 SECOND-ORDER COMPETENCY: MANAGES THE INTERNAL WORK UNIT ENVIRONMENT**

Whereas a leader’s proficiency in the areas of visioning, strategy creation and unit structuring are representative of longer-term decisions that are made on the basis of relatively non-malleable characteristics of the unit’s suprasystems, consideration must also be given to the more dynamic tactical aspects involved in the management of unit operations. Materials, technology and equipment breakages, for example, represent some formidable obstacles to the execution of even the most effective strategies that cannot be planned for, nor be avoided no matter the level of proficiency with which they were created or put in place. In addition, previously synchronous components of the conversion process can cease to function properly due to lapses in concentration and infrequent occurrences of human error (key messages are not relayed or critical deadlines are not met, etc.). This moves the discussion away from strategic- to tactical leadership, an approach that is concerned with shorter-term decisions, adaptation and the management of (surfacing) risk. The critical point to understand at this point is that no matter how effective the leader’s ‘blueprint’ is for unit performance, teams operate in dynamic tactical environments where things can quickly change. For this reason, the competency of manages the internal work unit environment<sup>151</sup> was deemed a further important addition to the South African graduate leader performance model. This second-order competency was defined as: *maintains a hands-off procedural view and executes in-process corrections as and when required to ensure that different components of the conversion process keep pulling in the same direction*. This competency was anchored by the first-order competencies of *situational updates*, *balances material resources*, *balances human resources*, *manages work sequencing* and *simulating challenging environments*. The underlying theme of this competency relates to a leader’s ability to ‘orchestrate’ the conversion technologies of the unit, quality assure the process and ensure the continued fluency thereof by serving in the capacity of a project manager for the team. Such orchestrations in which disparate and differentiated workflow actions/components are integrated in concert with

---

<sup>151</sup> In ‘leadership strataplex’ language, this behavioural performance dimension can be categorised as a business competency requirement.

temporal pacing (Argote & McGrath, cited in Cooper & Robertson, 1993) on “behalf of members for which the situation becomes too complex and multi-faceted” (Zaccaro et al., 2001, p. 464) for them to handle themselves can be categorised as a form of *management control*. On the one hand, control in this context means utilising the unit’s vision and strategy as a point of reference to monitor the overall conversion process as a ‘real-life’ and in ‘real-time’ portrayal thereof and acting where discrepancies (could) arise between the plan and that which actually transpires in front of the leader. Alternatively, in very dynamic conditions, control could also be construed as the ability of the leader to adapt the current operational blueprint in countering unforeseen circumstances to ensure the same output.

The above description of this second-order competency essentially captures three broad functions associated with the tactical management of a unit, all of which are also expected to articulate with some of the other variables included in the South African graduate leader performance model. Firstly, to be able to step in and correct faults in the system presupposes some form of monitoring has taken place – the identification of any performance gaps or improvement opportunities. Aspects to consider in this regard include continuous monitoring of resource consumption and needs, deviations from deadlines, the sequencing of events in the conversion process and how different components in the conversion process remain in timely exchanges with each other. These judgments are made in real time by maintaining a procedural overview of the conversion process. While a diagnosis of coordination and sequencing pathologies in the system is a necessary precondition for the employment of counterstrategies, at the same time it also provides a rich source of information providing the leader with actionable knowledge from which to plan or revise future conversion cycles. It follows that the competencies of manages the internal work unit environment and analyses and understands the unit’s external and internal work unit environment both affect the outcome variable of *environmental analytics* and that this, in turn, makes it easier for leaders to display competence on both competencies. These relationships are therefore motivated by the assumption that proficiency in the identification of coordination complications in real-time operations can enrich the analytics derived from *internal scanning*<sup>152</sup> that is part of a larger environmental scanning exercise where leaders consider the constraints and opportunities of both the internal and external environments of the unit.

Secondly, and once faults in the system have been identified, this competency denotes behaviours associated with an *executive* function. Rather than solving the roots of these problems and making wholesale changes to the overall ‘blueprint’ and mode of the unit, however, the focus here is on recalibrations and implementing short-term solutions to ensure the successful completion of the current conversion cycle as the immediate priority. To correct possible faults and maintain team synchronicity, leaders take action by altering project plans or deadlines, regulating the work speed of different members, shifting crucial resources between different components of the conversion process or providing personal support to help encumbered individuals along. In affecting these short-term improvisations leaders will most likely rely more on transaction methods (Bass, 1985) involving negotiations to temporarily prioritise the needs of the unit above those its members. Nonetheless, as success in doing so means that leaders can control and minimise deviations from the original plan, a positive causal pathway is hypothesised between the competency of manages the internal work unit environment and a second leadership outcome variable, that of *structural fit*.

Thirdly, in correcting faults in the system, high proficiency on this competency denotes behaviours associated with a *knowledge transfer* function as well. Thus, the effective employment of this competency assumes that leaders step in and take action to correct the decisions and behaviours of members in relation to their overall functions and expected contributions within a broader process and framework as an instructor facilitating learning in an actual real-world

---

<sup>152</sup> More specifically, leaders can supplement their understanding of followers’ talents, hopes, aspirations, etc. with a view on how these resources perform in real time and their reactions and efficacy under novel conditions.

scenario. In this regard, leaders' remedial actions are believed to serve as a guideline or 'memorandum' for the team that have just failed to satisfactorily complete a real-world 'experiential learning exercise'. The knowledge that is transferred through these remedial actions perhaps occurs on a highly abstract level, yet carries powerful signals about team effectiveness in terms of the strategies implemented, how the situation was approached, why coordination broke down, and how similar mistakes can be avoided in the future. For this reason, the competency of managers that manages the internal work unit environment is also expected to have positive, causal relationships with the leadership outcome variables of *metacognition* and *shared mental models*.<sup>153</sup>

### 2.7.1.10 REFLECTIONS

Although not a primary concern of the current study, the exposition of the second-order competencies presented above made reference to a wide array of leadership outcomes as well as certain causal pathways that are hypothesised to exist between specific second-order leadership competencies and these outcomes. The identification of the outcomes that are required from leaders in articulating with a 'yet-to-be-developed' unit performance@work competency model was likewise also a focal point of interest of the unfolding literature study. The objective of Chapter 2 was to explicate the full connotative meaning of the South African graduate leader performance construct. The connotative meaning lies in the internal structure of the construct (Kerlinger & Lee, 2000). In addition, the contention was that in arguing the relevance of these competencies and outcomes for the South African graduate leader and arguing the plausibility of the hypothesised pathways between these latent variables, the researcher would be able to provide evidence in support of the theoretical validity<sup>154</sup> (Mouton & Marais, 1988) of the conceptualisation of the graduate leader performance construct.

The current study, however, focused exclusively on the development of the PGLCQ and the evaluation of the construct validity of the construct-referenced inferences derived from its dimension scores. Apart from fitting the measurement model implied by the constitutive definition and the design intention of the PGLCQ, the construct validity of the PGLCQ (as one subscale of the GLPB) could have been more credibly evaluated by also fitting the (as of yet incomplete) structural model depicting the structural relations between the leadership outcomes as per Table 2.13 and the second-order graduate leader competencies. The logistical challenges associated with also developing the GLOQ and validating it prior to testing the (entire) performance structural model swayed the decision against this option. Nonetheless, evidence on the construct validity of the PGLCQ could be strengthened by demonstrating that a structural model that reflects the structural relations that according to the conceptualisation of the graduate performance construct exist between the second-order graduate leader competencies (i.e. that reflects the internal structure attributed to the graduate leader performance construct, interpreted behaviourally) fits data when the latent second-order competencies are operationalised via the PGLCQ as per Figure 2.15.

The level of competence that graduate leaders achieve on the competencies that constitute graduate leader performance is not the outcome of a random event but rather systematically determined by a complex nomological network of latent variables characterising the graduate leader and characterising the environment in which the graduate leader has to operate. The competencies are, however, themselves structurally interrelated. The competency potential latent variables and the situational latent variables therefore do not affect all competency variables directly but rather enter the competency structural model through specific portal

---

<sup>153</sup> More specifically, high proficiency on this competency is expected to inform followers' second-order team interaction content domain.

<sup>154</sup> According to Mouton and Marais (1988) the conceptualisation of a construct may be regarded as theoretically valid (i.e. permissible) if all the dimensions implied by the manner in which the construct is used in explanation and description is acknowledged in the constitutive definition of the construct and the dimensions are mutually exclusive.



competencies. The structural relations existing between the competencies therefore form part of the psychological mechanism that regulates graduate leader performance. Even though the competencies, and the structural relations that exist between them, constitute performance the structural relations existing between the competencies need be validly understood to understand why there is variance in the performance of graduate leaders (interpreted behaviourally).

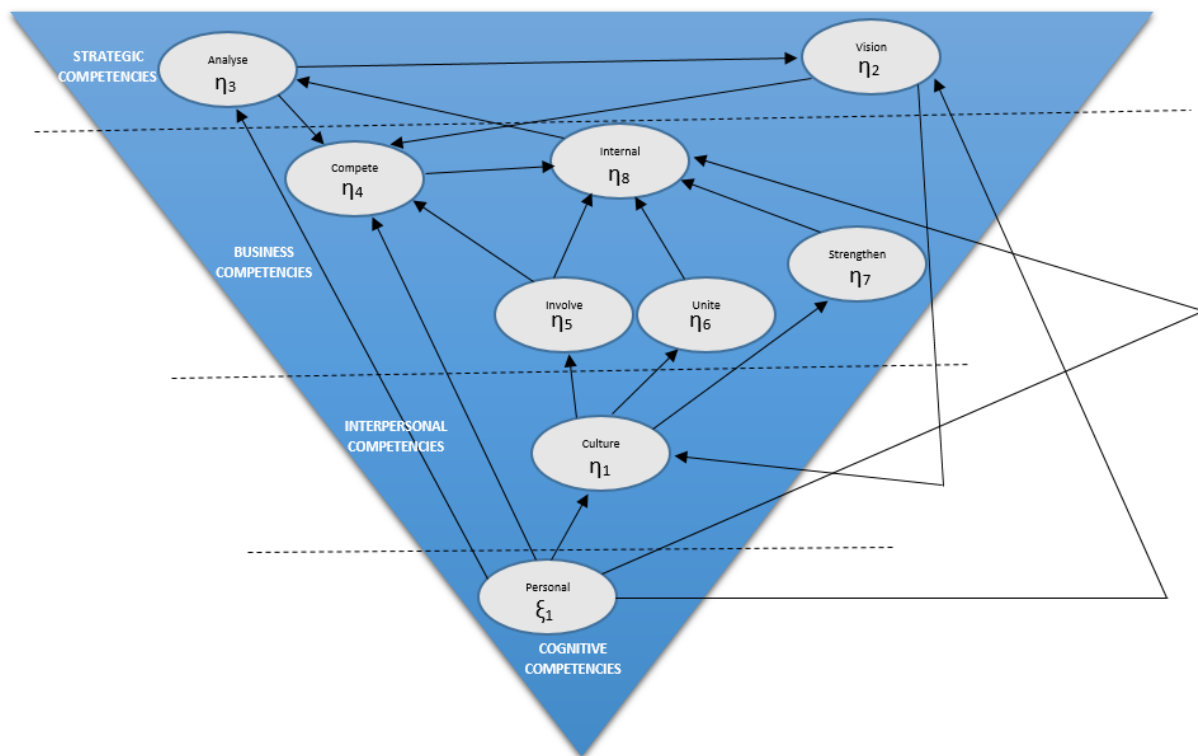
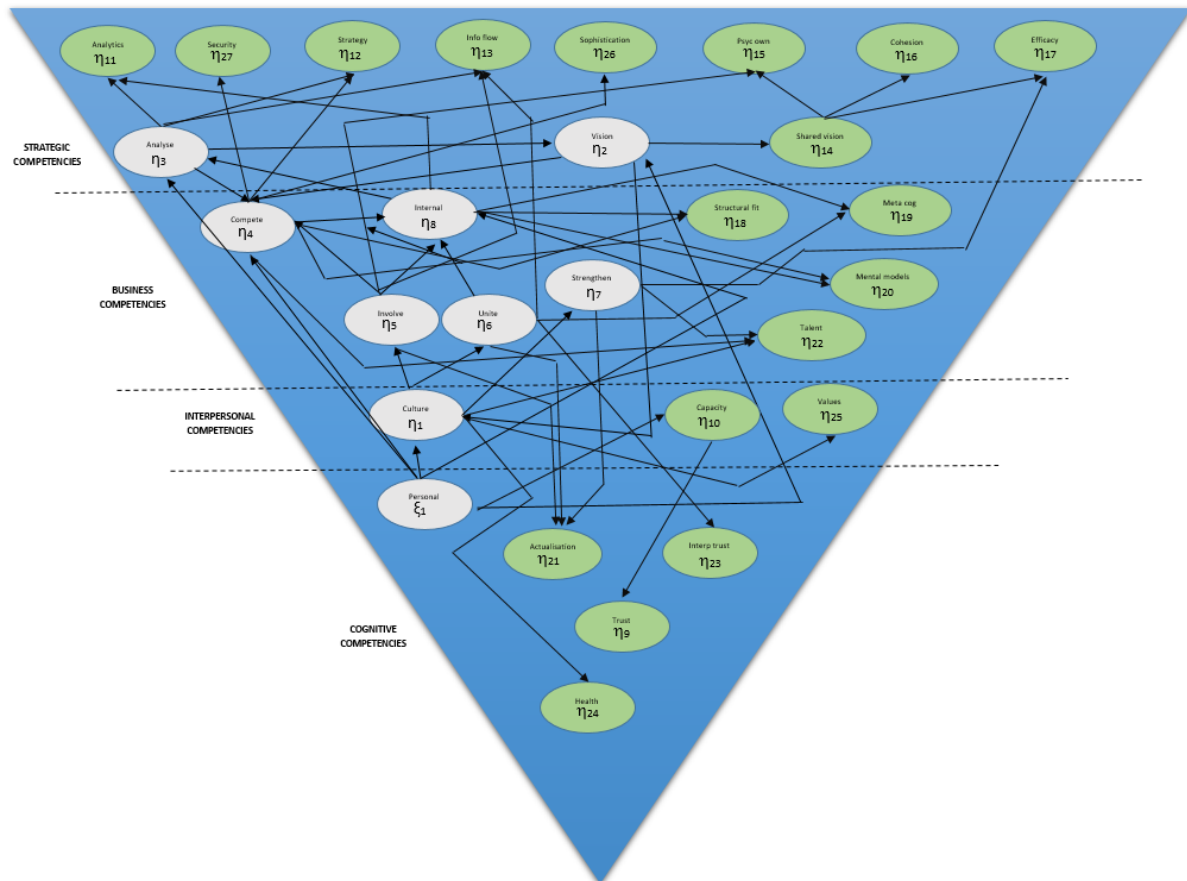

**Figure 2.15.** Graduate leader performance structural model (behavioural component) imposed on the Leadership Strataplex schematics

Note: Personal ( $\xi_1$ ) refers to the *displays personal leader proficiency* latent competency (COMP\_A); Analyse ( $\eta_3$ ) refers to the *analyses and understands the external and internal work unit environment* competency (COMP\_B); Vision ( $\eta_2$ ) refers to the *creates an exciting and aspirational vision for the unit* latent competency (COMP\_C); Culture ( $\eta_1$ ) refers to the *entrenches a high-performance culture in the unit* latent competency (COMP\_D); Compete ( $\eta_4$ ) refers to the *develops unit competitiveness* latent competency (COMP\_E); Involve ( $\eta_5$ ) refers to the *Involves others and elicits participation* latent competency (COMP\_F); Unite ( $\eta_6$ ) refers to the *unites and connects followers* latent competency (COMP\_G); Strengthen ( $\eta_7$ ) refers to the *strengthens and enables followers* latent competency (COMP\_H); and Internal ( $\eta_8$ ) refers to the *manages the internal work unit environment* latent competency (COMP\_I).

Figure 2.16 illustrates the manner in which second-order latent graduate leader competencies are hypothesised to structurally map onto relevant latent leadership outcome variable<sup>155</sup>.

<sup>155</sup> Figure 2.16 bears testimony to the research challenge facing the behavioural sciences that the phenomena it investigates are complexly determined.



**Figure 2.16.** Graduate leader performance structural model imposed on the Leadership Strataplex schematics

Note: Personal ( $\xi_1$ ) refers to the *displays personal leader proficiency* latent competency (COMP\_A); Analyse ( $\eta_3$ ) refers to the *analyses and understands the external and internal work unit environment* competency (COMP\_B); Vision ( $\eta_2$ ) refers to the *creates an exciting and aspirational vision for the unit* latent competency (COMP\_C); Culture ( $\eta_1$ ) refers to the *entrenches a high-performance culture in the unit* latent competency (COMP\_D); Compete ( $\eta_4$ ) refers to the *develops unit competitiveness* latent competency (COMP\_E); Involve ( $\eta_5$ ) refers to the *Involves others and elicits participation* latent competency (COMP\_F); Unite ( $\eta_6$ ) refers to the *unites and connects followers* latent competency (COMP\_G); Strengthen ( $\eta_7$ ) refers to the *strengthens and enables followers* latent competency (COMP\_H); and Internal ( $\eta_8$ ) refers to the *manages the internal work unit environment* latent competency (COMP\_I). Trust ( $\eta_9$ ) refers to the latent *trust in leadership* outcome; Capacity ( $\eta_{10}$ ) refers to the latent *unit capacity* outcome; Analytics ( $\eta_{11}$ ) refers to the latent *environmental analytics* outcome; Strategy ( $\eta_{12}$ ) refers to the latent *effective strategy* outcome; Info flow ( $\eta_{13}$ ) refers to the latent *functional information flow* outcome; Shared vision ( $\eta_{14}$ ) refers to the latent *emotional attachment to a shared vision* outcome; Psych own ( $\eta_{15}$ ) refers to the latent *unit psychological ownership* outcome; Cohesion ( $\eta_{16}$ ) refers to the latent *unit cohesion* outcome; Efficacy ( $\eta_{17}$ ) refers to the latent *unit efficacy* outcome; Structural fit ( $\eta_{18}$ ) refers to the latent *structural fit* outcome; Meta cog ( $\eta_{19}$ ) refers to the latent *unit meta cognition* outcome; Mental models ( $\eta_{20}$ ) refers to the latent *shared mental models* outcome; Actualisation ( $\eta_{21}$ ) refers to the *selfless self-actualisation*; Talent ( $\eta_{22}$ ) refers to the latent *talent availability* outcome; Interp trust ( $\eta_{23}$ ) refers to the latent *interpersonal trust* outcome; Health ( $\eta_{24}$ ) refers to the latent *psychological health* outcome; Values ( $\eta_{25}$ ) refer to the latent *high performance values* outcome; Sophistication ( $\eta_{26}$ ) refers to the latent *business sophistication* outcome and Security ( $\eta_{27}$ ) refers to the latent *resource security* outcome.

Although the current study exclusively focuses on the development of the PGLCQ, the foregoing theorising nonetheless resulted in a number of path-specific substantive hypotheses on the manner in which the second-order graduate leader competencies are expected to affect latent leadership outcome variables. These hypotheses focus exclusively on latent unit outcomes (i.e. malleable unit latent competency potential variables) and not individual follower outcomes. These are firstly important in explicating the connotative meaning of the competency domain of the graduate leader performance construct. The connotative meaning of a construct not only lies in its internal structure but also in the manner that it is structurally embedded in a larger

nomological network. At the same time, therefore, these hypotheses turn the first sod in explicating the internal structure of the graduate leader performance construct.<sup>156</sup>

## 2.8 CONCLUSION

Chapter 2 provided an in-depth literature review and a systemically reasoned argument to explicate a structural model that was offered as a definition of the graduate leader performance construct (interpreted behaviourally) as well as a partial hypothesis for why performance (behaviourally interpreted) differs across graduate leaders. The outcomes and behavioural demands imposed on the leadership role were distilled as an integrated whole from an analysis of the structural and process prerequisites that exist with regards to the various subsystems that comprise the organisation to allow the organisation to successfully combine and transform scarce input factors from the environment and output it as products and/or services valued by the environment. This effort advanced the longer term research agenda on graduate leader performance through 1) the full explication of the (yet-to-be-tested) graduate leader competency domain, 2) a partial explication of the graduate leader outcome domain (their identities were defined but the structural relations between variables were not explicated and is also yet to be tested), and 3) a further research breakthrough that explicated the hypothesised relationships between the (second-order) graduate leader competencies and outcome variables (also yet to be tested). Moreover, it was argued that the outcome variables that were explicated throughout the literature study can be viewed as the results that graduate leaders are expected to achieve in the organisation on the one hand, but that they also at the same time double as the competency potential variables for a (yet-to-be-developed) 'in-sequence' **work unit** competency model.

While the explicated outcome variables will not be used further for the purposes of the current study, they nonetheless contribute greatly in the sense of enriching our understanding of the connotative meaning of graduate leader performance (behaviourally interpreted) and the validity of inferences derived from measures thereof as a construct embedded in larger (work unit) nomological network. The chapter that follows will explain how the hypotheses underlying the structural model on graduate leader performance (behaviourally interpreted) were statistically defined and analysed. The chapter includes discussions on the qualitative and quantitative methodologies employed, the study's research design, measurement instrument (the PGLCQ) development procedures, and sampling strategy, as well as the statistical tools that were used to analyse the PGLCQ data.

---

<sup>156</sup> Figure 2.16 strikingly bears testimony to the complexity (Cilliers, 1998) characterising graduate leader performance.

## CHAPTER 3: RESEARCH METHODOLOGY

### 3.1 INTRODUCTION

It is the objective of the present study to develop and validate a South African graduate leader performance measure (PGLCQ)<sup>157</sup> that can be used to obtain multi-rater assessments of the *competency domain* of the generic, graduate leader performance construct. To achieve this objective Chapter 2 engaged in a systematic literature study and subsequent theorising in response to the research initiating questions formulated in Chapter 1 to conceptualise the graduate leader performance construct and explicate the connotative meaning of the construct. Chapter 3 will provide a comprehensive overview of the research methodologies employed for validating construct-referenced inferences derived from the instrument to measure the explicated graduate leader construct. For this purpose, it is fruitful to view the study's research design and methodologies employed in its entirety as an 'elegant snare' (Ehrenreich, 1991) that was designed for the exclusive purpose of 'capturing' or uncovering the 'cunning logic of nature', e.g. the identities of, measures for and ways in which second-order graduate leader competencies structurally combine to form part of the psychological mechanism that constitutes as well as (partially) regulates the level of performance that graduates attain on the behavioural component of the graduate leader job performance construct (behaviourally interpreted). The end goal was to provide a methodological approach that was widely accepted by knowledgeable, experienced researchers and through which unambiguous, empirical evidence could be generated with which to evaluate and affirm the validity of the proposed graduate leader competency domain model and the PGLCQ instrument. In explaining the rationale behind this 'snare' (Ehrenreich, 1991) and to motivate its objectivity, the following section will provide a detailed description of the methodological choices made at various critical stages of the study as well as the motivation for these choices. The chapter will cover discussions on the study's qualitative and quantitative methodologies, research design, measurement instrument (the PGLCQ) development procedures, sampling strategy, as well as the statistical tools that were used to analyse the PGLCQ data.

### 3.2 A MIXED METHOD APPROACH

In 'constructing' this competency (domain) model, the researcher also utilised qualitative sources of information over and above that which is currently available in the performance and leadership literature. That is to say that whilst the present research is motivated by technical interest and is rooted in the belief that the social world is governed by regularities that hold law-like properties that can be "uncovered" independently from people's shared views about social reality, it is also acknowledged that there is value in the exploration and understanding of the interpretive structures or socially constructed worlds of the people being studied (in this case subject matter experts such as graduate recruiters, hiring managers, training and development managers, etc.). George Kelly coined the term *person-as-scientist* (Previn, Carvone, & John, 2005, p. 387) as part of his personal construct theory to express the belief that, like behavioural scientists, non-scientists also develop explanatory hypotheses that allow them to predict significant events in their daily lives. Thus, man distinguishes himself from lower-level animals in terms of his self-consciousness and abstract thinking capacity or fluid intelligence. Man's abstract thinking capacity offers him the ability to develop abstract concepts and to construct interpretive structures from these in terms of which he makes sense of that which he experiences in and around himself (Babbie & Mouton, 2001; Previn, Carvone & John, 2005). Man lives his daily life in accordance with this

---

<sup>157</sup> The PGLCQ will be developed to measure the level of competence that the graduate leader displays on the second-order leader competencies at work.

interpretive structure (socially constructed phenomenological reality) and applies this to every domain of life including his approach to work. Thus, it is believed that experienced HR practitioners and line managers involved with the recruitment, selection, induction and performance management of graduates on a daily basis can, as lay behavioural scientists, put forward valuable hypotheses to supplement (or confirm) the (second-order) graduate themes derived from the research literature. It is moreover believed that as subject matter experts, HR practitioners and line managers experienced in dealing with and managing graduates are the most imminently qualified to assist with the generation of behavioural incidents with which to develop and anchor the scales of the PGLCQ. Despite these beliefs, the goal was not to understand the behaviour of the 'actor' (the participants) in order to critically inspect the interpretative structures that they have constructed (Babbie & Mouton, 2001) or to break down potentially debilitating (distorted, self-deceiving) interpretative structures that prevent them from living a fulfilling life (the idealist) where they were found (i.e. an emancipatory interest), but rather to co-opt these structures out of a technical cognitive interest as (potentially valid) hypotheses that could improve the results of the study. The framework underlying this research approach is illustrated in Figure 3.1 below.

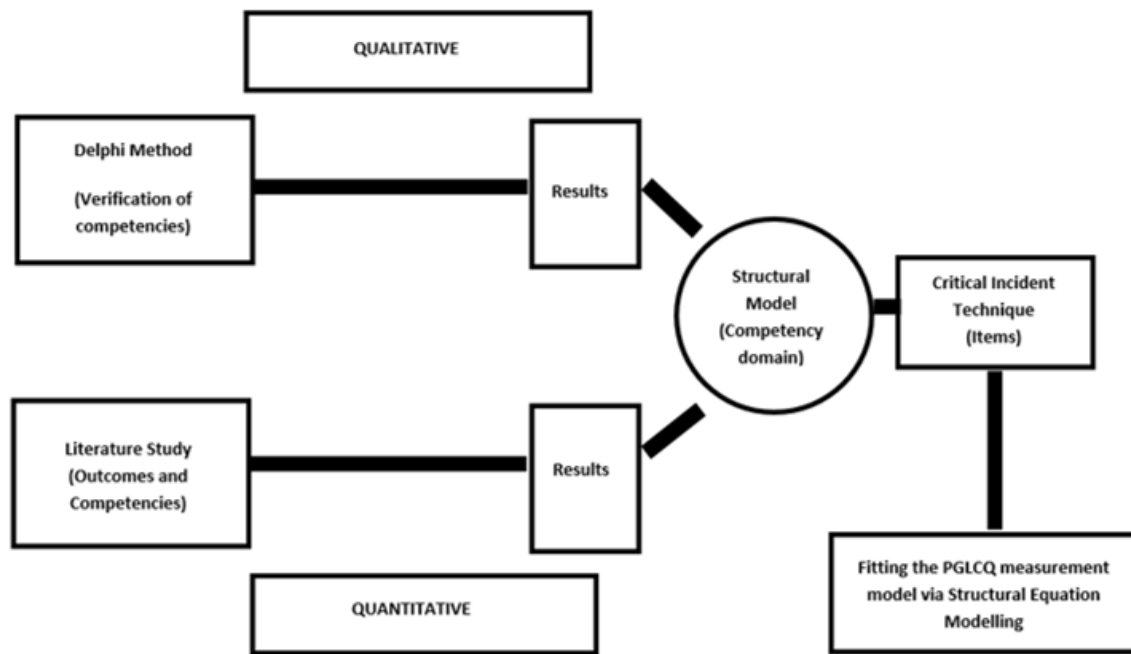

Figure 3.1. The research framework

The approach that was used could be summarised as a qual → QUAN mixed methods design (Creswell & Clark, 2018). On a practical level, the mixed methods approach to this research study translated into the following procedure:

- A review of (limited) literature on the expected generic work outcomes of graduate leaders in order to assemble a preliminary list of expected generic, South African graduate work outcomes (i.e. competency results);
- A comprehensive review of literature on performance theory in the identification of the required generic, South African graduate leader behaviours (i.e. competencies);
- The use of the **Delphi method** to confirm the relevance of the graduate leader competencies identified in the literature review and to explicate additional, generic competencies instrumental in outcome achievement, that are deemed to be important in the eyes of subject-matter experts;

- To integrate the above in proposing a structural model offered as a hypothesis for a generic South African graduate leader performance construct (behaviourally interpreted);
- The use of the **Critical Incident Technique** to explicate specific behavioural manifestations of “poor” and “excellent” performance on the demonstration of competencies as identified in the literature review and the Delphi technique (i.e. viewpoint of subject-matter experts); and
- Utilising Structural Equation Modelling in testing the performance structural model on real-world observations as measured by the Pienaar Graduate Leader Competency Questionnaire (PGLCQ).

In acknowledging, however, from a positivist perspective, that the interpretive structures of HR managers and line managers experienced in dealing with and managing graduates on a daily basis remain only (potentially valid) hypotheses on this phenomenon, the researcher closely observed the system advanced by Guba and Lincoln (Lincoln & Guba, 1985; Lincoln, 1995; for more *critically evaluating and inspecting* of the data collected in the field (see Table 3.1 below for a simplified explanation).

Table 3.1

	CONCEPT	DEFINITION
1.	Credibility	Confidence in the ‘truth’ of the findings.
2.	Transferability	Showing that the findings have applicability in other contexts
3.	Dependability	Showing that the findings are consistent and could be repeated
4.	Confirmability	Extent to which the findings of a study would be confirmed by other researchers.
5.	Authenticity	Is there consensus that the findings are ‘useful’ and have meaning (for action and next steps)?

*Criteria for defining and investigating quality in qualitative research*

Reprinted from Quality and Trustworthiness in Qualitative Research in Counseling Psychology, by Morrow, S.L., 2005, *Journal of Counseling Psychology*, 13(4), p. 252. Copyright 2005 by the American Psychological Association.

These criteria and how they were applied in safeguarding the study from the potentially debilitating effects of self-deceiving or distorted interpretive structures of the qualitative sample participants will be discussed in more detail where the Delphi method and Critical Incident research protocol is described later on in the chapter.

### 3.3 SUBSTANTIVE RESEARCH HYPOTHESES

The overarching substantive hypothesis (i.e. Hypothesis 1) of this study is that the PGLCQ provides a reliable and construct valid measure of the generic graduate leader (behavioural) competency domain as illuminated in Chapter 2. The overarching substantive hypothesis was in turn, dissected into two narrower substantive research hypotheses:

- Hypothesis 1a: The measurement model reflecting the constitutive definition of the graduate leader performance construct (interpreted behaviourally) and the design intent of the PGLCQ provides a valid account of the psychological mechanism that regulates test-takers' responses to the items of the PGLCQ; and

- Hypothesis 1b: The structural model implied by the connotative meaning of the graduate leadership performance construct (interpreted behaviourally) as expressed by the internal structure assigned to the construct taken in conjunction with the design intent of the PGLCQ provides a valid account of the psychological processes underpinning the level of performance that graduates attain on the behavioural components of the graduate leader job performance construct (i.e. on the second-order graduate leader competencies).

The overarching substantive hypothesis subsumed a number of more in-depth operational hypotheses. More specifically, operational hypotheses 1 – 5 were dissected from the first narrow substantive hypothesis and operational hypotheses 6 – 8 were derived from the second narrow substantive hypothesis:

- Operational hypothesis 1: The measurement model implied by the scoring key and the design intent of the PGLCQ in which the latent second-order graduate leader competencies have been operationalised via the individual items of the PGLCQ closely reproduces the covariances observed between the items included in each of the PGLCQ scales;
- Operational hypothesis 2: The factor loadings of the items on their designated (second-order) graduate leader competencies respectively are statistically significant ( $p < .05$ ) and large ( $\lambda_{ij} \geq .50$ );
- Operational hypothesis 3: The graduate leader (second-order) competencies duly explain large proportions of the variance in the items that represent them respectively;
- Operational hypothesis 4: The measurement error variances associated with each item are statistically significant ( $p < .05$ ) yet small ( $\theta_{\delta ii} \leq .75$ );
- Operational hypothesis 5: The graduate leader (second-order) competencies correlate statistically significantly ( $p < .05$ ) while not excessively large with each other ( $\phi_{ij} < .90$ ), providing evidence of *discriminant validity*;
- Operational hypothesis 6: The competency domain structural model implied by the manner in which the constitutive definition of the graduate leader behavioural performance construct defines the internal structure of the graduate leader performance construct (i.e. structurally links the (second-order) competencies in a nomological network of latent variables as described in Chapter 2) can closely reproduce the covariances observed between the items comprising each of the PGLCQ scales; and
- Operational hypothesis 7: The slope of the regression of  $\eta_j$  on  $\xi_i$  and the regression of  $\eta_j$  on  $\eta_i$  in the structural model implied by the manner in which the constitutive definition of the graduate leader behavioural performance construct embeds competencies in a nomological network of latent variables are statistically significant ( $p < .05$ ). Operational hypothesis 7 thus implies the testing of 18 path-specific substantive hypotheses as are also graphically depicted in Figure 3.2 below:
  - Path-specific substantive hypothesis 1: In the proposed graduate leadership@work competency domain structural model<sup>158</sup> it is hypothesised that a high level of personal leader proficiency ( $\xi_1$ ) will improve leadership effectiveness in entrenching a high-performance culture in the unit ( $\eta_1$ );
  - Path-specific substantive hypothesis 2: In the proposed graduate leadership@work competency domain structural model it is hypothesised that a high level of personal leader proficiency ( $\xi_1$ ) will improve leadership effectiveness in creating an exciting and aspirational vision ( $\eta_2$ );

---

<sup>158</sup> The phrase in the proposed graduate leadership@work competency domain structural model is used on purpose to reflect the fact that  $\gamma_{ij}$  and  $\beta_{ij}$  represent partial regression coefficients that reflect the average change in  $\eta_i$  associated with one unit change in  $\xi_j$  or  $\eta_j$  when controlling for the other latent variables in the structural equation of  $\eta_i$ .

- Path-specific substantive hypothesis 3: In the proposed graduate leadership@work competency domain structural model it is hypothesised that a high level of personal leader proficiency ( $\xi_1$ ) will improve leadership effectiveness in analysing and understanding the external and internal work unit environment ( $\eta_3$ );
- Path-specific substantive hypothesis 4: In the proposed graduate leadership@work competency domain structural model it is hypothesised that a high level of personal leader proficiency ( $\xi_1$ ) will improve leadership effectiveness in the development of unit competitiveness ( $\eta_4$ );
- Path-specific substantive hypothesis 5: In the proposed graduate leadership@work competency domain structural model it is hypothesised that a high level of personal leader proficiency ( $\xi_1$ ) will improve leadership effectiveness in the management of the unit's internal environment ( $\eta_8$ );
- Path-specific substantive hypothesis 6: In the proposed graduate leadership@work competency domain structural model it is hypothesised that high proficiency on the entrenchment of a high-performance culture ( $\eta_1$ ) will improve leadership effectiveness in strengthening and enabling followers ( $\eta_7$ );
- Path-specific substantive hypothesis 7: In the proposed graduate leadership@work competency domain structural model it is hypothesised that high proficiency on the entrenchment of a high-performance culture ( $\eta_1$ ) will improve leadership effectiveness in uniting and connecting followers ( $\eta_6$ );
- Path-specific substantive hypothesis 8: In the proposed graduate leadership@work competency domain structural model it is hypothesised that high proficiency on the entrenchment of a high-performance culture ( $\eta_1$ ) will improve leadership effectiveness in involving others and eliciting participation ( $\eta_5$ );
- Path-specific substantive hypothesis 9: In the proposed graduate leadership@work competency domain structural model it is hypothesised that high proficiency on involving and eliciting participation from others ( $\eta_5$ ) will improve leadership effectiveness in the development of unit competitiveness ( $\eta_4$ );
- Path-specific substantive hypothesis 10: In the proposed graduate leadership@work competency domain structural model it is hypothesised that high proficiency on analysing and understanding the external and internal work unit environment ( $\eta_3$ ) will improve leadership effectiveness in developing the unit's competitiveness ( $\eta_4$ );
- Path-specific substantive hypothesis 11: In the proposed graduate leadership@work competency domain structural model it is hypothesised that high proficiency on developing unit competitiveness ( $\eta_4$ ) will improve leadership effectiveness in managing the unit's internal environment ( $\eta_8$ );
- Path-specific substantive hypothesis 12: In the proposed graduate leadership@work competency domain structural model it is hypothesised that high proficiency on strengthening and enabling followers ( $\eta_7$ ) will improve leadership effectiveness in managing the unit's internal environment ( $\eta_8$ );
- Path-specific substantive hypothesis 13: In the proposed graduate leadership@work competency domain structural model it is hypothesised that



high proficiency on uniting and connecting followers ( $\eta_6$ ) will improve leadership effectiveness in managing the unit's internal environment ( $\eta_8$ );

- Path-specific substantive hypothesis 14: In the proposed graduate leadership@work competency domain structural model it is hypothesised that high proficiency on involving others and eliciting participation ( $\eta_5$ ) will improve leadership effectiveness in managing the unit's internal environment ( $\eta_8$ );
- Path-specific substantive hypothesis 15: In the proposed graduate leadership@work competency domain structural model it is hypothesised that high proficiency on the management of the unit's internal environment ( $\eta_8$ ) will improve leadership effectiveness in analysing and understanding the external and internal work unit environment ( $\eta_3$ );
- Path-specific substantive hypothesis 16: In the proposed graduate leadership@work competency domain structural model it is hypothesised that high proficiency on analysing and understanding the external and internal work unit environment ( $\eta_3$ ) will improve leadership effectiveness in the creation of an exciting and aspirational vision ( $\eta_2$ );
- Path-specific substantive hypothesis 17: In the proposed graduate leadership@work competency domain structural model it is hypothesised that high proficiency on the creation of an exciting and aspirational vision ( $\eta_2$ ) will improve leadership effectiveness in entrenching a high-performance culture in the unit ( $\eta_1$ );
- Path-specific substantive hypothesis 18: In the proposed graduate leadership@work competency domain model it is hypothesised that high proficiency on the creation of an exciting and aspirational vision ( $\eta_2$ ) will improve leadership effectiveness in developing the unit's competitiveness ( $\eta_4$ ); and
- Operational hypothesis 8: The structural error variances associated with each endogenous latent variable in the competency domain structural model are statistically significant ( $p < .05$ ) and large ( $\psi_{jj} \geq .70$ ).<sup>159</sup>

---

<sup>159</sup> The assumption is that the level of competence that graduate leaders achieve on the latent second-order graduate leader competencies are complexly determined by an extensive nomological net of latent competency potential latent variables and situational latent variables. Moreover, the current model also ignores possible feedback effects from latent outcome variables. This suggests that the latent competencies would explain relatively little variance in each other. On the other hand, it was also argued that the influence of the latent competency potential latent variables and situational latent variables enters the competency structural model through a limited number of portal latent competencies. This line of reasoning would in turn suggest that one could expect the model depicted in Figure 3.1 to at least explain moderate proportions of variance in those endogenous latent variables lying "deeper" into the model.

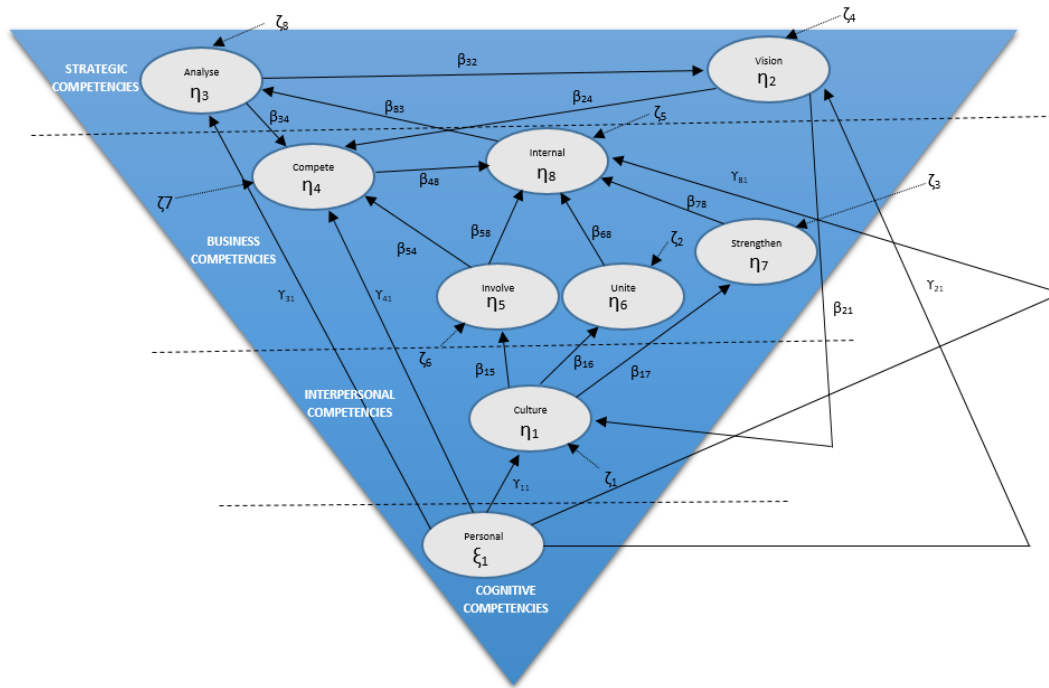

**Figure 3.2.** Graduate leader competency domain structural model imposed on the Leadership Strataplex schematics with LISREL notation added

Note: Personal ( $\xi_1$ ) refers to the *displays personal leader proficiency* latent competency (COMP\_A); analyse ( $\eta_3$ ) refers to the *analyses and understands the external and internal work unit environment* competency (COMP\_B); Vision ( $\eta_2$ ) refers to the *creates an exciting and aspirational vision for the unit* latent competency (COMP\_C); Culture ( $\eta_1$ ) refers to the *entrenches a high-performance culture in the unit* latent competency (COMP\_D); Compete ( $\eta_4$ ) refers to the *develops unit competitiveness* latent competency (COMP\_E); Involve ( $\eta_5$ ) refers to the *Involves others and elicits participation* latent competency (COMP\_F); Unite ( $\eta_6$ ) refers to the *unites and connects followers* latent competency (COMP\_G); Strengthen ( $\eta_7$ ) refers to the *strengthens and enables followers* latent competency (COMP\_H); and Internal ( $\eta_8$ ) refers to the *manages the internal work unit environment* latent competency (COMP\_I).

## 3.4 RESEARCH DESIGN

### 3.4.1 RESEARCH FRAMEWORK

The present study ultimately represented an attempt to produce knowledge of the world through the testing of hypotheses about causal relationships derived from scientific theories and to then evaluate these views empirically against real-world observations. However, although the present study thus had a deductive, quantitative focus, it was also argued that the use of a *mixed method approach* (or the addition of qualitative, deductive methods for data collection) could add depth the overall study. In this regard it was explained that the data obtained from the Delphi method would be fused with the results of the literature study and that the interpretative structures that HR practitioners and line managers had on the subject of graduate leader performance (as extracted by way of the Critical Incident Technique and as expressed in terms of the competencies that graduate leaders require to be successful in the world of work) would be used to aid in the development of the PGLCQ. Strictly speaking, the overall research design for this study (see Figure 3.1) can therefore be described as a mix between a type of *sequential explanatory* (the literature study is followed by the Delphi method to confirm the relevance of the extracted competencies) and *sequential exploratory* (the Delphi method is utilised to identify any additional competency themes that are relevant to the study and the Critical Incident Technique is used to develop items for the consequent analysis of the psychometric properties of the PGLCQ) *mixed design* (Creswell & Creswell, 2018). However, in order to analyse the data that constitute the core part of the study, it was also necessary to formally define the design of the quantitative data analysis procedures. The section that follows will explain how the numerical data of the study was quantified and subjected to statistical treatment in order to support or refute the statistical hypotheses of the study (Williams, 2007).

### 3.4.2 QUANTITATIVE RESEARCH DESIGN

Although a randomised experiment is the benchmark for ensuring the internal<sup>160</sup> (and external) validity of research findings and conclusions (Durheim, Painter, & Terre Blanche, 2006), the nature of this study (and more specifically the quantitative analysis) necessitated the use of an *ex post facto*<sup>161</sup> correlational research design. This design was the only option open to the researcher as the aim of the study was to test hypotheses about cause and effect relationships between latent variables (Diamantopoulos & Siguaw, 2000) of a psychological nature (i.e. the proficiency in the demonstration of competencies) in an actual business setting where it was difficult, if not impossible to experimentally manipulate these variables nor affect 'true' random subject assignment. Stated differently, it was not feasible to conduct a true experiment in this case as graduates' levels of competence achieved on the second- order leadership competencies could not conceivably be manipulated nor their membership of organisations<sup>162</sup> as the primary sampling units of the study.<sup>163</sup> This of course, is an unpleasant fact of life for many researchers in the field of applied social sciences who in order to investigate certain phenomena "naturally occurring" in nature, are forced to waive a certain amount of variable control and subject randomisation. However, in countering the argument that *ex post facto* research designs are fundamentally flawed or methodologically unsound and that experimental designs are always preferred/superior regardless of the field of application and study objectives, Meehl (as cited in Radner & Winokur, 1970, p. 374) argues as follows:

... Example: If we investigate schizophrenia, with an eye to either its genetic or its environmental determiners, we have to take schizophrenics as they come. This is because neither our scientific information nor our ethics permits us to produce schizophrenia experimentally, or to predetermine who is a potential schizophrenic and assign such persons randomly to nonschizophrenogenic family environments... if we are interested in economic behaviour of say, incentive-pay problems, we cannot have any assurance that a short-term laboratory microcosm involving learning nonsense syllables and "payment" in extra grade points represents an adequate experimental analogue, let alone an identical kind of psychological situation (only reduced in temporal scale), to the question with which we started... I make these familiar observations to avoid any possibility of being misunderstood as saying that only laboratory experiments, in which control and randomisation can be effectively imposed by the investigator, are intrinsically appropriate or scientific. Such a view is far from my philosophical position. There are good reasons, some practical and some methodological, for studying behavioural phenomena "in the state of nature." These reasons are sometimes so good that even the *ex post facto* design

---

<sup>160</sup> Internal validity refers to the permissibility of conclusions made regarding cause and effect findings, whilst external validity refers to the extent to which generalisations can be made from the findings of the research.

<sup>161</sup> An *ex post facto* research design is a systematic empirical inquiry in which the researcher has no direct control over independent variables because their manifestations have already occurred or because they cannot fundamentally be manipulated (Kerlinger & Lee, 2000). In contrast to true experimental designs where equivalent groups are subjected to different treatments, *ex post facto* research begins with groups that are already different and searches in retrospect for the reason(s) that brought about those differences (Cohen, Manion, & Morison, 2000).

<sup>162</sup> Graduates choose the organisations where they apply for vacancies and employers select the graduates that they deem the most appropriate for their organisations, and therefore membership to sampling units could not be truly randomised. The researcher was therefore forced to accept graduate membership to sampling units "as is".

<sup>163</sup> The choice of an *ex post facto* correlational design was also influenced, at least in the case of investigating the second narrow substantive hypothesis (and therefore operational hypotheses 6 and 7), because the hypothesis hypothesises numerous causal effects between numerous endogenous latent variables. An experimental design is unable to test causal hypotheses between endogenous [or dependent] variables. In fact, even if it would have been possible to utilise random assignment and experimental manipulation of the exogenous latent variables in the substantive hypothesis, an *ex post facto* correlational design would still have had to be used if the substantive hypothesis hypothesised causal paths between numerous endogenous latent variables. The design would, however, differ from the conventional *ex post facto* correlational design in that the exogenous latent variables would be operationalised via a single experimental manipulation rather than two or more measured indicators.

may be preferable to the laboratory method, and will in many cases be better than leaving an important problem unresearched.

The contention that researchers must recognise that “a tiger in the laboratory, or a tiger in the zoo, does not live in the same kind of stimulus field, and hence does not maintain the same kind of long-term psychological economy, as one in the Bengal jungle” (Meehl, cited in Radner & Winokur, 1970, p. 374) ultimately points to the fact that the observation of phenomena in their natural setting may have distinct advantages over an artificial experiment as is often contrived in laboratory settings (Meehl, cited in Radner & Winokur, 1970). This type of argument can likewise be applied to graduates that are participating in an accelerated leadership development programme where decisions made and actions taken there have real-life consequences for their livelihood, careers and their chances of progressing to senior leadership positions (i.e. their reputation, ongoing relationships with peers and managers, likelihood of promotion with concomitant pay raises, future positions in other organisations, etc.); factors that might not sufficiently weigh in on subjects in ‘simulated, surreal laboratory’ environments. Nonetheless, this type of *pseudo-experimental design* (Cohen, Manion, & Morison, 2000) does not offer opportunities for **randomisation** and **manipulation** as is the case with true experiments and therefore *ex post facto* research certainly does lack a degree of control (i.e. the “third variable problem”) and there is also a possibility that the researcher can interpret findings from such studies incorrectly (i.e. a relationship between variables does not necessarily mean causality).<sup>164</sup> The limitations of this type of design are also then particularly dangerous in situations where a study has no clearly defined hypothesis (Chamberlin, 1965).<sup>165</sup>

However, as the study has proposed a logical, theoretically sound job performance hypothesis (or a theoretical competency domain model) derived from casual theorising via a rigorous literature study, it is suggested that this weakness associated with the *ex post facto* research design will be minimised. In addition, the researcher has already proposed an overarching five domain competency model in which it is posited that over and above specific competencies, future graduate leader performance will also be influenced by competency potential, competency requirements, as well as various job demands and job resources in an effort to identify and declare beforehand, the existence of other extraneous variables that might also impact this particular study’s results. Regardless of this, the results and consequent interpretations from the analysis of sample data still needed to be treated with some level of caution (Kerlinger, 1986). The *ex post facto* correlational design that was used to test the first narrow substantive hypothesis and the specific operational hypotheses associated with the PGLCQ measurement model (operational hypotheses 1 – 5) is depicted in Figure 3.3 below.

The first narrow substantive hypothesis and operational hypotheses 1 – 5 essentially represent the position that the PGLCQ validly and reliably measures nine qualitatively distinct common factors. Here  $X_{ij}$  refers to the score of participant  $i$  on item  $j$  as a measure of the  $j^{\text{th}}$  exogenous latent variable ( $\xi_j$ ). The bracket around  $X_{ij}$  indicates that the latent variable  $\xi_j$  will be measured rather than experimentally manipulated. The design depicted in Figure 3.3 (and 3.4) also assumes that each of the 9 subscales of the PGLCQ consists of 10 items. The design requires that the measurement model be fitted with the individual items as indicators of the second-order graduate leader competencies.

---

<sup>164</sup> Incidentally, this is also a well-documented criticism against the use of Structural Equation Modelling (SEM) (Chin, 1998; Kelloway, 1998; Sobel, 1996). However, casual assumptions are still derived from research design, prior studies, scientific knowledge, logical arguments, temporal priorities and other evidence that the researcher can marshal in support of them. Accordingly, the authenticity of conclusions made about the causality observed between variables in SEM studies as such depends on the credibility of the causal assumptions made rather than on the statistical methodology itself.

<sup>165</sup> Confirmation bias is applicable here in the form of ‘creator affection for a ruling theory’, leading to a tendency to disregard/ignore any alternative explanations for results (Chamberlin, 1965).

[X <sub>11</sub> ]	[X <sub>12</sub> ]	[X <sub>13</sub> ]	...	[X <sub>1j</sub> ]	...	[X <sub>1.90</sub> ]
[X <sub>21</sub> ]	[X <sub>22</sub> ]	[X <sub>23</sub> ]	...	[X <sub>2j</sub> ]	...	[X <sub>2.90</sub> ]
...	...	...	...	...	...	...
[X <sub>i1</sub> ]	[X <sub>i2</sub> ]	[X <sub>i3</sub> ]	...	[X <sub>ij</sub> ]	...	[X <sub>i.90</sub> ]
...	...	...	...	...	...	...
[X <sub>n1</sub> ]	[X <sub>n1</sub> ]	[X <sub>n3</sub> ]	...	[X <sub>nj</sub> ]	...	[X <sub>n.90</sub> ]

Figure 3.3. The research design logic to test operational hypotheses 1–5

The second narrow substantive hypothesis and operational hypotheses 6 and 7 essentially put forward the position that the nine common factors measured by the PGLCQ are in fact the nine second-order competencies constituting the graduate leader performance construct (interpreted behaviourally). The *ex post facto* variant design that was used to test the second narrow substantive hypothesis and the operational hypotheses associated with the comprehensive LISREL model (operational hypotheses 6 – 8) is depicted in Figure 3.4 below. Here  $X_{ij}$  represents the  $i^{\text{th}}$  observation obtained on the  $j^{\text{th}}$  exogenous latent variable ( $\xi_j$ ). The bracket indicates that variable  $\xi_j$  will be measured rather than experimentally manipulated.  $Y_{ik}$  represents the  $i^{\text{th}}$  observation obtained on the  $k^{\text{th}}$  endogenous latent variable ( $\eta_k$ ). In this *ex post facto* design variant, the comprehensive LISREL model was also fitted with all of the individual items as indicators of the second-order graduate competencies.

[X <sub>11</sub> ]	[X <sub>110</sub> ]	Y <sub>11</sub>	Y <sub>12</sub>	...	Y <sub>1k</sub>	...	Y <sub>1.80</sub>
[X <sub>21</sub> ]	[X <sub>210</sub> ]	Y <sub>21</sub>	Y <sub>22</sub>	...	Y <sub>2k</sub>	...	Y <sub>2.80</sub>
...	...	...	...	...	...	...	...
[X <sub>i1</sub> ]	[X <sub>i10</sub> ]	Y <sub>i1</sub>	Y <sub>i2</sub>	...	Y <sub>ik</sub>	...	Y <sub>i.80</sub>
...	...	...	...	...	...	...	...
[X <sub>n1</sub> ]	[X <sub>n10</sub> ]	Y <sub>n1</sub>	Y <sub>n2</sub>	...	Y <sub>nk</sub>	...	Y <sub>n.80</sub>

Figure 3.4. The research design logic to test operational hypotheses 6–7

### 3.5 STATISTICAL TECHNIQUE: STRUCTURAL EQUATION MODELLING

While the basic logic implicit to the authentication of the PGLCQ as a construct valid and reliable measure of the competencies included in the graduate leader competency domain model and the confirmation of the connotative integrity thereof is captured in Figures 3.3 and 3.4, a more detailed account of the logic underlying the *ex post facto* fitting of a model via structural equation modelling<sup>166</sup> (SEM) is nonetheless required. This is necessary because, as briefly mentioned in the preceding paragraph, one deals with and investigates different (or variant) models when performing statistical analyses in SEM, which can cause confusion for someone that is not particularly familiar with this statistical technique's underlying methodology and terminology. A general structural equation model comprises a complex, composite statistical hypothesis and is

<sup>166</sup> The overarching goal of SEM analysis is to determine the extent to which a theoretical model is supported by sample data (Schumacker & Lomax, 2010).

fundamentally made up of two parts (Jöreskog, cited in Duncan & Goldberger, 1973), namely the measurement and path (or structural) models. The *measurement model* represents “a set of  $p$  observable variables as multiple indicators of a smaller set of  $m$  latent variables” (Ćurković\*, 2012, p. 273). This is the model that was fitted to test the first 5 operational hypotheses of the current study. It links latent variables (i.e. graduate (leader) second-order competencies) to observed variables (i.e. measures of PGLCQ items) by way of a restricted (confirmatory) factor model, which was used to verify the measurement hypothesis that specific items of the PGLCQ instrument reflect graduate leaders’ standing on specific latent graduate leader competencies prior to (adding) the investigation of the regressions among latent variables as postulated in the graduate (leader) competency domain model presented at the end of Chapter 2 (to the equation).

Fitting the measurement model provides a limited test of the construct validity of the construct-referenced inferences derived from the dimension scores of the PGLCQ. The PGLCQ constitutes the measurement hypothesis that the instrument measures nine latent graduate leader (second-order) competencies that manifest themselves in the response to specific items but not others. The measurement hypothesis concedes that the response of test-takers to the items of the PGLCQ are not only determined by a specific latent competency but also influenced by random and systematic non-relevant error influences. The measurement hypothesis can (in part) be depicted as a set of nine measurement equations. To fully specify the measurement hypothesis (or to fully specify the measurement model) an explicit position should be taken as to whether the nine latent graduate leader (second-order) competencies are assumed to be correlated and whether the measurement error influences are assumed to be correlated. The measurement hypothesis essentially represents the design intent underpinning the PGLCQ. If the measurement model fits the empirical data (i.e. if the fitted model can at least closely reproduce the observed inter-item covariances) and the estimates obtained for the measurement model parameter estimates are statistically significant and of an appropriate magnitude, it can be concluded that the design intent succeeded and that inferences about a specific latent variable can confidently be derived from the items that were earmarked to reflect it in terms of the measurement hypothesis. Such a finding would, however, still constitute insufficient evidence to conclude that the PGLCQ successfully measured the nine latent graduate leader (second-order) competencies as constitutively defined.

The connotative meaning of a construct lies in the internal structure of the construct (i.e. the number of latent dimensions it comprises and the manner in which these latent dimensions structurally or correlationally link to each other) and in the manner in which the construct is structurally embedded in a larger nomological network of latent variables that are conceptually distinct from the construct. To more confidently conclude that the designated PGLCQ items measure the specific latent graduate leader (second-order) competency they were developed to reflect as it was constitutively defined, it thus needs to be shown that the path models describing the manner in which these latent dimensions structurally (or correlationally) link to each other and the manner in which the construct is structurally embedded in a larger nomological network of latent variables, are both conceptually distinct from the construct.

The *path model* provides a (comprehensive) nomological hypothesis<sup>167</sup> on a phenomenon under investigation and links latent (exogenous and endogenous) variables underlying this hypothesis to each other in a set of conjectured dependent/causal relations expressed as a path diagram. The path model of the current study is represented by the graduate (leader) competency domain model that was developed in Chapter 2 that reflects part of the internal structure of the graduate leader performance construct. In this form, however, the path model was not actually used in this study for conducting any SEM analyses. The path model as such cannot be subjected to an

---

<sup>167</sup> The nomological network would be termed a theory when the comprehensive LISREL model has been shown to fit empirical data, the measurement model has been shown to fit empirical data, the hypothesised paths have been shown to be statistically significant and the path coefficient estimates have been shown to be sufficiently large. Kerlinger and Lee (2000) regard a theory as a set of latent variables, their constitutive definition and “proven statements” on the nature of the causal relationship between them.

empirical test. The path model is fully constituted by abstract latent variables. However, when the measurement model and path models are combined, the result is referred to as the *comprehensive LISREL* model. The comprehensive LISREL model can accordingly be described as a system of simultaneous (measurement and structural) equations incorporating observed variables, latent variables, and the dependencies (and even possibly causalities) between the observed and latent variables and between the latent variables. Therefore, the comprehensive LISREL model expresses the researcher's underlying logic as to why the indicator variables correlate in the manner that they do in terms of the structural relations that exist between the observed and latent variables and between the latent variables and makes a more comprehensive confirmatory assessment of construct validity possible. It was thus the fitting of this comprehensive LISREL model that served as a more stringent confirmatory assessment of the nomological validity of the graduate (leader) competency domain model linked to the operational hypotheses 6-7.

When fitting models in SEM procedures, researchers can utilise a covariance-based analysis (CB-SEM) or a variance-based approach, namely that of partial least squares (PLS-SEM) (Gefen, Straub, & Boudreau, 2000; Hair, Sarstedt, Ringle, & Mena, 2012). With CB-SEM, the primary aim is to reproduce the observed covariance matrix, with only a secondary focus on explained variance, while PLS-SEM aims to maximise the explained variance of the dependent constructs (Hair, Ringle, & Sarstedt, 2011). There were several reasons for adopting a CB-SEM approach in the current study, the most important of which are that it is reported to be the most appropriate option for the testing of a theoretical framework (Hair, Anderson, Tatham, & Black, 1998) and that most of the statistical theory underlying SEM was initially developed on the assumption that such analyses apply to a covariance, and not a correlation matrix (Bentler, Bagozzi, Cudeck, & Iacobucci, 2001). CB-SEM is therefore superior to PLS-SEM because it provides more accurate chi-square statistics and standard errors, and provides a correlation metric (which is the sole focus of PLS-SEM) as part of its analysis output as well (Bentler et al., 2001). Byrne (2012, p. 1) describes the fitting of both measurement and comprehensive LISREL models by way of a CB-SEM approach as follows:

(SEM is) a statistical methodology that takes a confirmatory (i.e. hypothesis-testing) approach to the analysis of a structural theory bearing on some phenomenon... The hypothesised model can then be tested statistically in a simultaneous analysis of the entire system of variables to determine the extent to which it is consistent with the data. If goodness of fit is adequate, the model argues for the plausibility of postulated relations among variables; if it is inadequate, the tenability of such relations is rejected.

Thus, to test the extent to which the developed graduate (leader) competency domain model was supported by the sample data, the researcher had to gather measurements of all the observed variables and calculate the inter-item covariance matrix and the inter-indicator covariance matrix (in fitting the measurement and comprehensive LISREL models separately). Estimates of the freed (measurement and structural model) parameters were acquired by way of an iterative method with the intention of reproducing the observed inter-indicator covariance matrix as accurately as possible. Should a situation have arisen where a fitted model failed to reproduce the observed covariance matrix, the researcher would have duly concluded that the measurement model implied by the design intention of the PGLCQ (or the comprehensive LISREL model also reflecting the graduate (leader) competency domain model) did not suffice as an acceptable explanation for the observed inter-indicator covariance matrix. If this transpired, the researcher would have concluded that either the PGLCQ failed to measure the construct it was intended to measure or that the postulated graduate (leader) competency domain model failed to provide a plausible description of the mechanism that regulates the behavioural component of graduate leader performance. That is to say that the graduate (leader) competency domain model could only have been considered valid or a permissible explanation for graduate leader (behavioural) performance; 1) if after the fitting of the measurement model evidence was obtained to support

the hypothesised measurement intent of the PGLCQ; and 2) the comprehensive LISREL model itself subsequently at least closely fitted the available empirical data (Babbie & Mouton, 2001).

However, if the covariance matrices derived from both the estimated model parameters did closely correspond with the observed covariance matrices, this would not necessarily have implied that it was the psychological processes postulated by the graduate (leader) competency domain structural model that produced this likened resemblance. On the contrary, a high degree of fit between the observed and estimated covariance matrices could have occurred for a number of reasons with the psychological processes postulated by the graduate (leader) competency domain model simply providing *one plausible* (yet convincing) *explanation* for this.

### 3.6 STATISTICAL HYPOTHESES

The overarching substantive hypothesis (i.e. Hypothesis 1) claimed that the PGLCQ provides a reliable and construct valid measure of the graduate leader performance construct (interpreted behaviourally). The overarching substantive hypothesis was in turn, dissected into two narrower substantive research hypotheses:

- Hypothesis 1a: The measurement model reflecting the constitutive definition of the graduate leader performance construct (interpreted behaviourally) and the design intent of the PGLCQ provides a valid account of the psychological mechanism that regulates test-takers responses to the items of the PGLCQ; and
- Hypothesis 1b: The structural model implied by the connotative meaning of the graduate leadership performance construct (interpreted behaviourally) as expressed by the internal structure assigned to the construct taken in conjunction with the design intent of the PGLCQ provides a valid account of the psychological processes underpinning the level of performance that graduates attain on the behavioural components of the graduate leader job performance construct.

The first narrow substantive hypothesis (i.e. Hypothesis 1a) proposed that if the PGLCQ provides a construct valid and reliable measure of the behavioural component of graduate (leader) job performance as constitutively defined in accordance with the design intent of the instrument, then the PGLCQ measurement model should fit item data obtained on the PGLCQ. If this claim is to be interpreted to suggest that the hypothesised measurement model provides an exact account of the psychological mechanism that produced the observed inter-item covariance matrix in the parameter, this argument translates into the following *exact fit* hypothesis:

$H_{01}$ : RMSEA = 0

$H_{a1}$ : RMSEA > 0

However, this is a rather idealistic claim especially in the field of social sciences in which any theoretical model can at best only be expected to offer a proximal account of reality (Browne & Cudeck, cited in Bollen & Long, 1992).<sup>168</sup> Taking the unwavering position that a theoretically derived model can so closely reproduce an observed covariance matrix to the degree that any sample deviation from it can only be explained through naturally occurring sampling error may therefore be detrimental to the study. Hence, in acknowledging the more likely possibility that the measurement model hypothesised to underlie the PGLCQ will only be able to approximate the processes that in reality created the observed covariance matrix, the following *close fit* null hypothesis ( $H_{02}$ ) was also tested (Browne & Cudeck, cited in Bollen & Long, 1992):

---

<sup>168</sup> Byrne (2012, p. 68) argues that this is an impractical assumption for real-life situations and that “all postulated models (no matter how good) can only ever fit real-world data *approximately*”. Browne and Cudeck, cited in Bollen and Long (1992, p. 137) consequently elaborate: “it is implausible that any model that we use is anything more than an approximation to reality. Since a null hypothesis that a model fits exactly in some population is a priori to be false, it seems pointless even to try and test whether it is true”.



$H_{02}$ : RMSEA  $\leq$  .05

$H_{a2}$ : RMSEA  $>$  .05

$H_{02}$  represents a statistical translation of operational hypothesis 1. It follows that if either  $H_{01}$  and/or  $H_{02}$  was not rejected and exact and/or close fit had been achieved, or alternatively if the measurement model at least demonstrated reasonable fit, it was considered permissible to interpret the estimates obtained for the freed measurement model parameters by testing operational hypotheses 2 – 5.

Operational hypothesis 3 was tested by testing the following 90 null hypotheses on the slope of the regression of item  $j$  on specific latent graduate leader competencies  $k$  (i.e. by testing the following 90 null hypotheses on the freed elements of  $\Lambda$ ):

$H_{0i}$ :  $\lambda_{jk} = 0$ ;  $i=3, 4, \dots, 92$ ;  $j = 1, 2, \dots, 90$ ;  $k = 1, 2, \dots, 9$

$H_{ai}$ :  $\lambda_{jk} > 0$ ;  $i=3, 4, \dots, 92$ ;  $j = 1, 2, \dots, 90$ ;  $k = 1, 2, \dots, 9$ <sup>169</sup>

Operational hypothesis 4 was tested by testing the following 90 null hypotheses on the freed elements in the variance-covariance matrix  $\Theta_{\delta}$ :

$H_{0i}$ :  $\theta_{\delta ij} = 0$ ;  $i = 93, 94, \dots, 182$ ;  $j = 1, 2, \dots, 90$

$H_{ai}$ :  $\theta_{\delta ij} > 0$ ;  $i = 93, 94, \dots, 182$ ;  $j = 1, 2, \dots, 90$

Operational hypothesis 5 was tested by testing the following 36 null hypotheses with regards to the freed elements in the variance-covariance matrix  $\Phi$ :

$H_{0i}$ :  $\phi_{kp} = 0$ ;  $i = 183, 184, \dots, 218$ ;  $k = 1, 2, \dots, 9$ ;  $p=1, 2, \dots, 9$ ;  $j \neq k$

$H_{ai}$ :  $\phi_{kp} > 0$ ;  $i = 183, 184, \dots, 218$ ;  $k = 1, 2, \dots, 9$ ;  $p=1, 2, \dots, 9$ ;  $j \neq k$

The second narrow substantive hypothesis (i.e. Hypothesis 1b) proposed that if the PGLCQ provides a construct valid and reliable measure of the behavioural component of graduate (leader) job performance as constitutively defined in accordance with the design intent of the instrument, then the PGLCQ competency domain comprehensive LISREL model should fit item data obtained on the PGLCQ. If this claim is to be interpreted to suggest that the hypothesised comprehensive LISREL model provides an exact account of the psychological mechanism that produced the observed inter-item parcel covariance matrix in the parameter, this argument translates into the following *exact fit* hypothesis:

$H_{0219}$ : RMSEA = 0

$H_{a219}$ : RMSEA  $>$  0

When acknowledging the more likely possibility that the comprehensive LISREL model hypothesised to underlie the PGLCQ will only be able to approximate the processes that in reality created the observed inter-item parcel covariance matrix, the following *close fit* null hypothesis ( $H_{0220}$ ) was also tested (Browne & Cudeck, cited in Bollen & Long, 1992):

$H_{0220}$ : RMSEA  $\leq$  .05

$H_{a220}$ : RMSEA  $>$  .05

$H_{0220}$  represents a statistical translation of operational hypothesis 6. It follows that if either  $H_{0219}$  and/or  $H_{0220}$  was not rejected and exact and/or close fit had been achieved, or alternatively if the comprehensive model at least demonstrated reasonable fit (given that  $H_{01}$  and/or  $H_{02}$  had not been rejected), it was considered permissible to interpret the estimates obtained for the freed

---

<sup>169</sup> The directional Hai hypotheses imply that all the items of the PGLCQ were coded so that they load positively on the latent competency they were earmarked to reflect.

structural model parameters by testing operational hypotheses 7. Operational hypothesis 7 implies the testing of the following 18 path-specific substantive hypotheses by testing the following 18 null hypotheses:

Path-specific substantive hypothesis 1: In the proposed graduate leadership@work competency domain model it was hypothesised that a high level of *personal leader proficiency* will improve leadership effectiveness in *entrenching a high-performance culture* in the unit.

$$H_{0221}: \gamma_{11} = 0$$

$$H_{a221}: \gamma_{11} > 0$$

Path-specific substantive hypothesis 2: In the proposed graduate leadership@work competency domain model it was hypothesised that a high level of *personal leader proficiency* will improve leadership effectiveness in creating an *exciting and aspirational vision*.

$$H_{0222}: \gamma_{21} = 0$$

$$H_{a222}: \gamma_{21} > 0$$

Path-specific substantive hypothesis 3: In the proposed graduate leadership@work competency domain model it was hypothesised that a high level of *personal leader proficiency* will improve leadership effectiveness in *analysing and understanding the external and internal work unit environment*.

$$H_{0223}: \gamma_{31} = 0$$

$$H_{a223}: \gamma_{31} > 0$$

Path-specific substantive hypothesis 4: In the proposed graduate leadership@work competency domain model it was hypothesised that a high level of *personal leader proficiency* will improve leadership effectiveness in the *development of unit competitiveness*.

$$H_{0224}: \gamma_{41} = 0$$

$$H_{a224}: \gamma_{41} > 0$$

Path-specific substantive hypothesis 5: In the proposed graduate leadership@work competency domain model it was hypothesised that a high level of *personal leader proficiency* will improve leadership effectiveness in the *management of the unit's internal environment*.

$$H_{0225}: \gamma_{81} = 0$$

$$H_{a225}: \gamma_{81} > 0$$

Path-specific substantive hypothesis 6: In the proposed graduate leadership@work competency domain model it was hypothesised that high proficiency on the *entrenchment of a high-performance culture* will improve leadership effectiveness in *strengthening and enabling followers*.

$$H_{0226}: \beta_{71} = 0$$

$$H_{a226}: \beta_{71} > 0$$

Path-specific substantive hypothesis 7: In the proposed graduate leadership@work competency domain model it was hypothesised that high proficiency on the *entrenchment of a high-performance culture* will improve leadership effectiveness in *uniting and connecting followers*.

$$H_{0227}: \beta_{61} = 0$$

$$H_{a227}: \beta_{61} > 0$$

Path-specific substantive hypothesis 8: In the proposed graduate leadership@work competency domain model it was hypothesised that high proficiency on the *entrenchment of a high-performance culture* will improve leadership effectiveness in *involving others and eliciting participation*.

$H_{0228}: \beta_{51} = 0$

$H_{a228}: \beta_{51} > 0$

Path-specific substantive hypothesis 9: In the proposed graduate leadership@work competency domain model it was hypothesised that high proficiency on *involving others and eliciting participation* will improve leadership effectiveness in the *development of unit competitiveness*.

$H_{0229}: \beta_{45} = 0$

$H_{a229}: \beta_{45} > 0$

Path-specific substantive hypothesis 10: In the proposed graduate leadership@work competency domain model it was hypothesised that high proficiency on *analysing and understanding the external and internal work unit environment* ( $\eta_3$ ) will improve leadership effectiveness in *developing the unit's competitiveness*.

$H_{0230}: \beta_{43} = 0$

$H_{a230}: \beta_{43} > 0$

Path-specific substantive hypothesis 11: In the proposed graduate leadership@work competency domain model it was hypothesised that high proficiency on *developing unit competitiveness* will improve leadership effectiveness in *managing the unit's internal environment*.

$H_{0231}: \beta_{84} = 0$

$H_{a231}: \beta_{84} > 0$

Path-specific substantive hypothesis 12: In the proposed graduate leadership@work competency domain model was hypothesised that high proficiency on *strengthening and enabling followers* will improve leadership effectiveness in *managing the unit's internal environment*.

$H_{0232}: \beta_{87} = 0$

$H_{a232}: \beta_{87} > 0$

Path-specific substantive hypothesis 13: In the proposed graduate leadership@work competency domain model it was hypothesised that high proficiency on *uniting and connecting followers* will improve leadership effectiveness in *managing the unit's internal environment*.

$H_{0233}: \beta_{86} = 0$

$H_{a233}: \beta_{86} > 0$

Path-specific substantive hypothesis 14: In the proposed graduate leadership@work competency domain model it was hypothesised that high proficiency on *involving others and eliciting participation* ( $\eta_5$ ) will improve leadership effectiveness in *managing the unit's internal environment* ( $\eta_8$ );

$H_{0234}: \beta_{85} = 0$

$H_{a234}: \beta_{85} > 0$

Path-specific substantive hypothesis 15: In the proposed graduate leadership@work competency domain model it is hypothesised that high proficiency on the *management of the unit's internal*

*environment* will improve leadership effectiveness in *analysing and understanding the external and internal work unit environment*.

$$H_{0235}: \beta_{38} = 0$$

$$H_{a235}: \beta_{38} > 0$$

Path-specific substantive hypothesis 16: in the proposed graduate leadership@work competency domain model it was hypothesised that high proficiency on *analysing and understanding the external and internal work unit environment* ( $\eta_3$ ) will improve leadership effectiveness in the *creation of an exciting and aspirational vision*.

$$H_{0236}: \beta_{23} = 0$$

$$H_{a236}: \beta_{23} > 0$$

Path-specific substantive hypothesis 17: In the proposed graduate leadership@work competency domain model it was hypothesised that high proficiency on the *creation of an exciting and aspirational vision* will improve leadership effectiveness in *entrenching a high-performance culture* in the unit.

$$H_{0237}: \beta_{12} = 0$$

$$H_{a237}: \beta_{12} > 0$$

Path-specific substantive hypothesis 18: In the proposed graduate leadership@work competency domain model it was hypothesised that high proficiency on the *creation of an exciting and aspirational vision* will improve leadership effectiveness in *developing the unit's competitiveness*.

$$H_{0238}: \beta_{42} = 0$$

$$H_{a238}: \beta_{42} > 0$$

Operational hypothesis 8 was tested by testing the following 8 null hypotheses on the freed elements in the variance-covariance matrix  $\Psi$ :

$$H_{0i}: \psi_{kk} = 0; i = 239, 240, \dots, 246; k = 1, 2, \dots, 8$$

$$H_{ai}: \psi_{kk} > 0; i = 239, 240, \dots, 246; k = 1, 2, \dots, 8$$

### 3.7 MEASUREMENT INSTRUMENT – THE DEVELOPMENT OF THE PGLCQ

The PGLCQ was developed to obtain multi-rater assessments of the latent graduate leader competency variables that the behavioural domain of the South African graduate leader competency model comprises of in order to:

- Enable the development and empirical testing of a competency domain structural model as a basis for future efforts to build on and subsequently develop and empirically test a comprehensive structural model for the South African graduate leader performance construct in its entirety and to eventually develop and empirically test a comprehensive competency model for the South African graduate leader; and
- Allow the summative and formative evaluation of the level of competence that graduate leaders have achieved on a graduate development programme.

It was argued in Chapter 1 that insights into the psychological mechanism that regulates the level of competence that graduate leaders achieve on the competencies that (in part) constitute graduate leader performance is vital to inform HR interventions aimed at proactively and reactively increasing the performance of graduates as future leaders, and thus to positively affect future economic growth and prosperity in the South African society through high-performance

leadership in industry. To empirically test a comprehensive competency model that describes the manner in which structurally interrelated latent graduate leader competency potential latent variables and situational latent variables directly and/or indirectly determine the level of competence achieved on a structurally interrelated set of latent (second-order) graduate leader competency variables that in turn, directly and/or indirectly determine the level of competence achieved on a structurally interrelated set of latent graduate leader outcome variables, questionnaires are required to measure the latent outcome variables, the latent (second-order) competencies and the various competency potential latent variables and situational latent variables. The current study is turning the first sod on this multiphase project by developing and validating a measure to provide multi-rater assessments of the nine latent second-order graduate leader competencies (the PGLCQ). Once the construct validity of the PGLCQ has been established<sup>170</sup> (by obtaining support in favour of operational hypotheses 1 – 8) it paves the way for the development and validation of the Graduate Outcome Questionnaire (GLOQ) and the development and empirical testing of the (full) graduate leader performance domain structural model.

Moreover, once credible evidence has been led on the construct validity of the PGLCQ it opens up the possibility of utilising the PGLCQ to also provide formative feedback to graduates (i.e. on their performance or developmental progress on important leadership competencies) that are busy with their journey towards becoming strategic leaders of business units. Ultimately, therefore, it was necessary to be able to validly measure the competencies included in the competency domain structural model to not only test and corroborate the claims postulated by the graduate leader performance (behaviourally interpreted) structural model, but also to establish a framework for measuring and providing feedback on graduate performance (or leadership development) at work. To this end, the development of the PGLCQ instrument was broken down into a number of sequential steps as is explained in more detail below.

### **3.7.1 STEP 1: THE DELPHI METHOD**

The first step in the development of the PGLCQ involved gaining consensus from the side of experienced subject matter experts in industry that the second-order competencies gleaned from the literature study and that were lined up for use in the measurement instrument could indeed be confirmed as contemporary behavioural performance requirements of (graduate) leaders in the world of work. This was done in an additional attempt to fortify claims of the content validity of the second-order competencies that were explicated from the literature study completed in Chapter 2. To test the relevance of the explicated competencies as to their applicability in the contemporary South African work setting, the researcher employed the Delphi method. The Delphi method is a technique involving a group communication process that aims to achieve “convergence of opinion concerning real-world knowledge solicited from experts<sup>171</sup> within certain topic areas” (Hsu & Sandford, 2007, p. 1). In essence, the technique involves a series of questionnaires using multiple iterations to collect data from a panel of selected<sup>172</sup> experts (Hsu & Sandford, 2010). Accordingly, the underlying methodology of the Delphi technique involves a series of rounds where in each round, every participant works through a questionnaire which is returned to the researcher who in turn, collects, edits and returns to each participant a statement

---

<sup>170</sup> It is acknowledged that the term *established* fails to adequately convey the fact that the construct validity of any instrument is never really definitively verified. Rather, in a continuous process where construct explication (or conceptualisation), construct validation (Messick, cited in Linn, 1989) and construct explication (or reconceptualisation) follow each other, the connotative meaning of a construct is deepened and refined and confidence in the permissibility (or validity) of the construct-referenced inferences on test-takers’ standing on the construct as constitutively defined derived from the scores obtained on the instrument increases.

<sup>171</sup> The selection of panellists who are simply knowledgeable on the topic is not sufficient nor recommended (Helmer & Rescher, 1959; Klee, 1972; Oh, 1974).

<sup>172</sup> The choice of subject matter experts will be discussed under sampling strategy in paragraph 3.7.

of the position of the whole group in relation to the participant's own position (Ludwig, 1994). Although, theoretically, this iterative feedback process can continue for much longer, consensus is typically achieved within three rounds (Brooks, 1979; Custer, Scarcella, & Stewart, 1999; Cyphert & Grant, 1971) because each participant is made aware of the range of opinions and reasons underlying different opinions (Ludwig, 1994), which allows and encourages panellists to reassess their initial judgements in previous iterations and become increasingly more 'problem-solving orientated' (Hsu & Sandford, 2007) as the process unfolds.

Although in classical applications, the first round of the Delphi technique usually begins with an open-ended questionnaire that solicits specific information about a content area of interest, in this study the process was modified as information concerning the target issue (i.e. the relevance of the second-order competencies for graduate leaders in the world of work) were already available for use (Kerlinger, 1973). Therefore, the process was expedited and the first round was conducted by way of a structured questionnaire that was based on an extensive review of the literature (Hsu & Sandford, 2007) during which the importance of the explicated second-order (graduate) leader competencies were put to the test. The panellists were required to rate the importance of the nine explicated second-order (graduate) leader competencies and state/motivate the rationale for their assigned ratings (Jacobs, 1996). Panellists were provided with the constitutive definitions of each second-order graduate leader competency. Panellists were also provided with the definitions of the first-order competencies that 'load' onto each second-order competency to help more clearly describe the breadth of the second-order competencies. All second-order leadership competencies were rated by making use of a five-point Likert scale as graphically portrayed in Figure 3.5 below. In order to confirm the relevance of the second-order competencies that were lined up for inclusion in the PGLCQ, panellists had to affirm and reach consensus on a rating of at least 3 for each competency. If the consensus was that one or more of the second-order competencies included in the PGLCQ were not regarded as significant to graduate leader performance 'in the real world' (i.e. a consensus rating of less than 3), the conclusion was that the position that was derived from the literature study of scientific research findings had been challenged by the experiential method of knowing, that the theoretical competency domain model was claimed to suffer from construct contamination,<sup>173</sup> and that the current conceptualisation of the graduate leader performance construct (interpreted behaviourally) had to be critically reviewed both in terms of the number of second-order competencies and the internal structure of the construct.

<b>COMPETENCY 1: Creating an exciting and aspirational vision for the unit.</b>	<i>On a scale of 1-5, please indicate your opinion on the degree of relevance that the competency defined below holds for the evaluation of the performance of graduates (as future leaders) in South African business</i>			
	<i>The extent to which the graduate leader attracts and rallies a wide follower base towards an inspiring and exciting future vision of what can be achieved and how their lives can be fulfilled and become more meaningful by joining and investing in such a cause.</i>			
<b>IRRELEVANT</b>	<b>MARGINALLY RELEVANT</b>	<b>RELEVANT</b>	<b>MODERATELY RELEVANT</b>	<b>HIGHLY RELEVANT</b>
1	2	3	4	5

Figure 3.5. Likert scale format utilised in scaling the salience of second-order graduate leader competencies

Criticism levelled by the panel against the relevance of any given second-order competency was, however, not interpreted as *ipso facto* valid criticism. Rather, it was treated as *prima facie* evidence of construct contamination that shifted the burden of persuasion back to the researcher

<sup>173</sup> In a selection or assessment context, *criterion contamination* refers to a situation where the actual criterion (i.e. second-order competencies) contain factors/dimensions that are irrelevant to graduate (leader) performance (Truxillo, Bauer, & Erdogan, 2016).

to rebut the argument/motivation put forward by the panel in support of their low assigned ratings. Only if the researcher failed to convincingly rebut the construct contamination allegation of the panel was the second-order competency allowed to remain part of the connotative meaning of the graduate leader performance construct. The panellists were also required to indicate whether the graduate leader performance construct (interpreted behaviourally) suffered from any construct deficiency,<sup>174</sup> to provide a definition of the omitted second-order competency and to state/motivate the rationale for proposing the addition of the specific additional competency. Claims of construct deficiency were treated in essentially the same way as claims of construct contamination.

As a result of round one, areas of disagreement and agreement were identified (Ludwig, 1994), collated and summarised. In addition to the qualitative reasons panellists provided for assigned ratings, the major statistics that were considered for use in organising data of the collective judgements of the relative importance of these second-order competencies were measures of central tendency<sup>175</sup> (i.e. mean, median and mode) and level of dispersion (i.e. standard deviation, variance and inter-quartile range) (Hasson, Keeny, & McKenna, 2000). The median or mean scores obtained for each second-order competency were particularly useful (Jacobs, 1996) and were utilised as the primary indicators of panellists' collective rating, both for gauging consensus and providing feedback. An outlier standard deviation obtained for any given competency was, however, allowed to signal prudence in the interpretation of the measures of central tendency. Likewise, outlier observations were allowed to signal prudence in the interpretation of the measures of central tendency. In round two, a well-organised summary of qualitative and quantitative responses was sent to all participants who were requested to reassess their initial judgements based on their ability to now review and assess the comments and collective feedback provided by the other (anonymous) Delphi panellists (Dalkey, cited in Dalkey, Rourke, Lewis, & Snyder, 1972). More specifically, panellists were requested to revise their judgements or to provide specific reasons why they chose to remain outside the consensus (Pfeiffer, 1968) zone where this was the case. This process continued until all of the panellists' responses converged around a consensus score for each second-order competency without the investigator *moulding* panellists' opinions (Altschuld, 2003) towards this end.

With reference to the quality system for the evaluation of qualitative research methods endorsed by Guba and Lincoln (Lincoln & Guba, 1985; Lincoln, 1995) as discussed earlier in this chapter, the researcher is of the opinion that the use of the Delphi method and the manner in which it was planned to be implemented complied with all of the criteria of their typology. The *credibility* of the findings was ensured as the participants were asked to provide an indication (or a quantitative rating) of how relevant they feel the second-order competencies are for graduate leader performance in the world of work. Participants' position on the relevance of the second-order competencies were therefore formally quantified (in the form of a rating scale) and the researcher did not rely on extensive interpretation of the subject matter experts' feedback on the matter as would normally be the case in qualitative research. Participants' scores were moreover compared with each other (as part of an iterative process resembling an unfolding peer debriefing where participants justified their ratings to each other as part of a prolonged engagement with the subject matter), and were only 'accepted' if and where all ratings converged around a consensus score. Thus, although the Delphi method can be used to solicit qualitative information

---

<sup>174</sup> In a selection or assessment context, *criterion deficiency* refers to a situation where the actual criterion (i.e. the second-order graduate leader competencies) fails to (sufficiently) overlap with the conceptual criterion (i.e. the second-order graduate leader construct as constitutively defined) (Truxillo et al., 2016).

<sup>175</sup> Note that strictly speaking, the use of **interval** measurements is appropriate for the calculation of the median and Likert scales are inherently nothing more than tools for **ordinal** measurement (Norman, 2010). However, framing the Likert scale from the perspective of the relative power of the respondent's conviction as to the validity of the claims made in the scale was an attempt at bestowing upon it some degree of the interval property of *equidistance*. Regardless, the decision to use the mean or median for feedback purposes was governed by the form of the actual distributions obtained in the sample (i.e. normal distribution or skewed distribution).

from participants for the purpose of exploration, this was not the case here as it essentially served as a medium through which quantitative ratings were collected and subsequently analysed. A number of different sources was also used to triangulate the findings, which again speaks to the credibility of the findings. For these same reasons, the researcher also did not generally question the *dependability* (findings are consistent and could be repeated) of the Delphi method findings. The contention is therefore that the procedural vigour associated with participants being asked to iteratively reassess their initial judgements in several phases based on the feedback of other knowledgeable peers and the use of triangulation, (in terms of different sources) in converging on a consensus ('true') score ultimately maximised the potential replicability of the findings as well. With regards to *authenticity* (meaningful results in terms of taking action and further steps) it can be said that the Delphi method in essence involved nothing more than a member checking exercise (i.e. subject-matter experts in the graduate recruitment fraternity) which is widely regarded as the benchmark for guaranteeing the authenticity of qualitative methodological findings. As the same participants that were targeted as a sample for this part of the study in essence would also serve as the end-users of the findings of the study, it follows that agreement on the relevance of the second-order graduate leader competencies for the world of work would at the same time would also confirm end-user meaningfulness (in terms of taking it further or action steps). This of course presupposes that an appropriate sample (size) would be obtained for the qualitative part of the study and that consensus on the relevance of the (second-order) competencies would indeed be realised.

Because of these beliefs about the authenticity, dependability and credibility of the Delphi method findings, the *transferability* thereof was also not questioned. If the theoretical graduate leader competency model did not suffer from any construct deficiency or contamination, the Delphi method findings (i.e. what the critical competencies are that are required for graduate leaders to be effective in the world of work) would naturally be relevant and transferable to a number of different HR applications (i.e. succession planning, remuneration, performance management, etc.). However, because of the current study's unique research approach, the transferability of the Delphi method's findings was admittedly largely reliant on the accuracy and quality of the literature review and not on the contributions of participants themselves as is the case in other qualitative studies. The Delphi method participants only had the rate the extracted competency themes in terms of relevance to the world of work. It is true that the Delphi method allowed participants the opportunity to motivate the inclusion of further second-order competencies 'in-process' that were not identified previously in the literature study. However, claims of construct deficiency was treated as an opportunity to test possible new additions in a subsequent round of the Delphi and was not accepted as *ipso facto* valid criticism. Rather, it was treated as *prima facie* evidence of construct deficiency that shifted the burden of persuasion to the involved panellist and provided the rest of the panel an opportunity to confirm or refute this claim (by way of their ratings) in a subsequent round (triangulation) of the Delphi. Participants therefore did not have free reign in terms of exploring their own interpretive structures during the exercise as no additional competency themes would be added to the competency set under discussion without the agreement of the entire panel.

Finally, the fact that participants were given the opportunity to question the validity of the second-order competencies as extracted from the literature study (and propose the inclusion of others from their own interpretive structure) speaks to the *confirmability* component of Guba and Lincoln's (Lincoln & Guba, 1985; Lincoln, 1995) framework as well. While the researcher in essence was 'feeding' the participants second-order themes as gleaned from the literature study, they were nonetheless given the opportunity to confirm or disaffirm the relevance of these themes, and to even add some of their own to the equation, which effectively limited the potential of the researcher's own biases, motivations and perspectives on the topic influencing the Delphi method results. In fact, the researcher had little to no contact with the Delphi method participants during the completion of the questionnaires as these were distributed and collected electronically, and participants completed the questionnaires by themselves.



### 3.7.2 STEP 2: THE CRITICAL INCIDENT TECHNIQUE

After the Delphi exercise was completed, the absence of construct deficiency confirmed and the relevance of the second-order graduate leader competencies verified, the next phase involved the explication of specific behavioural examples that could be used to “anchor” the positive and negative poles of the latent second-order (graduate) leader competencies included in the PGLCQ via the Critical Incident Technique (CIT). Initially developed by John Flanagan (1954), the CIT has been described as a “well established qualitative research tool” (FitzGerald, Seale, Kerins, & McElvaney, 2008, p. 300) that has been applied successfully in many and varied research projects in such fields as nursing, dentistry, medicine (FitzGerald et al., 2008), counselling, psychotherapy, aviation, training/education, and the design of equipment and standard operating procedures (Flanagan, 1954). The essence of the technique involves asking participants to recall a specific incident<sup>176</sup> and to recount the incident to the observer, focusing on: 1) a detailed description of the incident; 2) a description of the actions/behaviours of those involved in the incident; 3) a description of the circumstances under which the incident occurred; and 4) the results or outcomes of the incident with the aim of capturing a detailed description of the behaviours of the participants being studied, rather than recording a generalisation or opinion thereof (Victoroff & Hogan, 2006). The CIT is therefore a “systematic effort to gather and analyse specific incidents of effective or ineffective behaviour” (FitzGerald, et al., 2008) in situations that are regarded as ‘critical’ for success in an activity that is being studied, and relies only on reports from qualified observers (Flanagan, 1954). Hence, the CIT method is particularly useful in exploring competencies, which have previously been defined as sets of behaviours that are instrumental in the delivery of the desired outcomes (Bartram, 2004).

Accordingly, the participating subject matter experts for this study were referred to a specific, second-order (graduate) leader competency identified in the literature study and as vetted by the Delphi method, and asked to think of a graduate that they consider to be one of the best performers on this competency that they know or have known.<sup>177</sup> The participant was given the constitutive definition of the competency under discussion and was then asked to justify their choice of graduate by describing specific (behavioural) incidents that illustrate the graduate’s proficiency on the second-order competency under investigation. The subject-matter experts were probed for valuable information by asking the following questions:

- 1) *Think of a graduate who, according to your personal assessment, is one of the best performers on the second-order competency of X. The competency in question can be defined as: (second-order competency definition to be included here).<sup>178</sup>*
- 2) *Please motivate your position that this graduate is highly competent on competency X by describing specific incidents that illustrate the individual’s competence in this regard.*
- 3) *Please explain exactly what the graduate did and why you regard this as a good illustration of his or her competence in this area.*

The resulting answers from the subject matter experts were recorded and the same line of questioning repeated for the same competency, except this time the participant was asked to relate the same questions to a graduate they consider to be a poor or less effective performer with

<sup>176</sup> A critical incident is defined as an event that makes the difference between success and failure (FitzGerald et al., 2008) with regards to the theme that is being studied.

<sup>177</sup> In this way, the two worlds of theory and reality were ‘merged’ by populating theoretical constructs with real-world behavioural examples.

<sup>178</sup> It is important to note that the critical incidents were not generated for each of the first-order competencies that conceptually load on a specific second-order competency. This would have resulted in an excessively long questionnaire comprising *circa* 500 items (given 100 first-order competencies and 5 items per subscale). When controlling for practical considerations this would have been the ideal methodological route to have followed. It would have resulted in a number of subscales for each second-order competency scale that could legitimately be expected to be unidimensional subscales. It would provide an extremely detailed and thorough description of the competency profile of graduate managers. It would in addition then also have allowed the fitting of a second-order measurement model to empirically examine the claim that specific first-order competencies load on specific second-order competencies.

regards to the competency in question. Moreover, all panellists were requested to provide examples of critical behaviours signifying a high or low standing on all nine of the explicated second-order graduate leader competencies, thereby providing for a rich and extensive experimental databank from which to commence item generation for the PGLCQ.

With reference to the quality system of Guba and Lincoln (Lincoln & Guba, 1985; Lincoln, 1995), the researcher again believes that the qualitative methodology employed here and the manner in which it was planned to be implemented complied with the all of the criteria included in their typology. Although the researcher had time and logistical impediments which restricted him from utilising triangulation and peer debriefings (the PGLCQ targeted at least 90 questions with behavioural incidents of 'poor' and 'good' performance) as additional safeguards, an attempt was made to member-check the behavioural incidents with other sample participants as far as possible in ensuring the *credibility* (confidence in the 'truth') of the CIT findings. This was possible as the CIT also relies on the participation of subject matter experts on the topic under investigation, who in this case doubled as both participants and member 'researchers'. CIT sessions were accordingly concluded with a brief overview of some of the behavioural anchor examples that other participants provided on the same competency theme, in order to cross-validate the data. Ultimately, it is also argued that the sheer amount of time that the researcher would spend (in terms of prolonged engagement with subject matter experts) in extracting the behavioural incidents for the second-order competency themes further contributed to the *credibility* of the extracted information. Regarding the *dependability* of the behavioural incidents extracted, the researcher acknowledges that these would not necessarily be duplicated or replicated 'as is' should the CIT exercise be repeated on another sample of SAGEA members. However, at the same time it can be argued that this is not a strict requirement for the purpose of this part of the study in any case as the aim of this stage of the research is to develop a questionnaire and not to extract a complete phenomenologically valid understanding of the competency themes. The competency themes have already been co-opted (for most part) from the literature study. *Dependability* in this context rather refers to whether the behavioural incidents extracted and which were subsequently transformed into questionnaire items, could ensure eventual scale reliability. In this regard, it is generally accepted that between 6 and 8 good-performing items are sufficient for measuring a single construct reliably (Nemoto & Beglar, 2014), but this does not mean that other items (or behavioural samples) do not exist that could also be used to measure the same construct (equally well). Regardless, the sheer amount of time that the researcher would spend engaging with subject-matter experts on the 9 themes again satisfied him as to the coverage that the extracted behavioural incidents would offer and that the knowledge pool on the subject matter would be exhausted.

Thirdly, the researcher also believes that the *confirmability* (findings shaped by participants and not the researcher's biases, motivations or perspectives) of the CIT's findings were also sufficiently safeguarded. This was achieved by strictly adhering to the CIT interview structure as outlined above and by probing participants as to **their** understanding of the specific behaviours underlying second-order competency themes. The researcher specifically refrained from assisting participants when asking for help or when he was asked to provide examples of behavioural incidents in moving the discussions along. Instead, the researcher consistently quoted the exercise instructions and only utilised the definitions of the competencies as gleaned from the literature, when he was asked for clarification. Fourthly, and as was already touched on in the discussion on the Delphi technique, it must be noted that there was a real danger that the *transferability* (the applicability of findings to other contexts) of the CIT could be negatively impacted by a lack of precision and care with which a number of sequential tasks were completed before and after administering the CIT. These include the literature study, the thematic analysis of the first-order competencies, the collection and dissemination of data during the Delphi technique exercise, and the item writing phase for the PGLCQ. Nonetheless, the researcher is of the opinion that this type of methodological shortcomings would not influence the qualitative part of the study's results in terms of negatively affecting construct deficiency and contamination.

The literature study and thematic analysis would be mythologically rigorous, and the information collected from SAGEA member representatives meticulous and faithfully recorded in a neutral manner. Consequently, the results of the CIT could be regarded as highly *transferable* in that the understanding of work-related (performance) behaviour is what is at the heart of the Industrial-Organisational psychological profession, and that HR practitioners have been utilising the CIT for precisely this purpose (capturing behavioural incidents to inform a number of interventions simultaneously such as training and development, performance management and remuneration interventions) since its inception in the 1950's.

Finally, with regards to Guba and Lincoln's (Lincoln & Guba, 1985; Lincoln, 1995) *authenticity* criteria, it can again be said that the nature of the CIT required the use of a group of subject-matter experts as a sample group and therefore the PGLCQ and its data were (indirectly) already shared with the eventual end-users during the course of the study. Although participation in the research cannot strictly speaking be equated to the formal sharing of the study's results for the purpose of meaningful discussion and criticism amongst peers or colleagues as a 'finished product', involvement in the CIT nonetheless invited participant feedback and their (implicit) agreement in effect signalled their acquiescence that organisational practises in the country should be refined in accordance with the competency themes and their accompanying behavioural anchors that were under discussion.

### 3.7.3 STEP 3: ITEM DEVELOPMENT FOR THE PGLCQ

The specific behavioural examples supplied by subject-matter experts (i.e. incidents associated with a high or low standing on each of the second-order graduate leader competencies) during Step 2 were collated and consequently utilised to develop items for each of the subscales of the PGLCQ by using the constitutive definition of each competency as cogency guidelines. The success with which the items were generated in this way was considered critical in establishing the initial content validity<sup>179</sup> of the questionnaire (Clark & Watson, 1995), which is often viewed as the minimum requirement for sound measurement (Hinkin, 1995) and is also the first step in the construct validation<sup>180</sup> of a new measure (Schriesheim, Powers, Scandura, Gardiner, & Lankau, 1993). Therefore, item generation targeted the ideal of developing relatively homogenous item sets<sup>181</sup> (Hogan, cited in Page, 1983) that could provide relatively pure expressions (via the respondents' behavioural responses to it) (Fourie, 2015) of the latent second-order performance dimensions they each were expected to reflect. Basic principles of item writing were adhered to including the use of simple, straightforward language appropriate for the reading level of the PGLCQ's target population, as well as the avoidance of double-barrelled questions and trendy expressions and colloquialisms (Clark & Watson, 1995).

---

<sup>179</sup> Westen and Rosenthal (2003) define content validity as the extent to which a measure adequately samples the content of the domain that constitutes the construct (i.e. do the different behavioural expressions in the scale adequately sample the performance dimension in question?).

<sup>180</sup> Cronbach and Meehl (1955) proposed that the investigation of the construct validity of a measure involves the articulation of a set of theoretical concepts and their interrelations (i.e. the nomological net), developing ways to measure the constructs proposed by the theory, and the empirical testing of the hypothesised relations among constructs. Construct validity can be viewed as an encompassing form of validity and is defined as the extent to which a measure adequately assesses the construct(s) it purports to assess (Bernstein & Nunally, 1994). Construct validity is a key element in differentiating (organisational) psychology as a science from other non-scientific approaches (Clark & Watson, 1995).

<sup>181</sup> It could be argued that the scales of the PGLCQ cannot be expected to be unidimensional given that they explicitly profess to measure broad second-order graduate leader competencies each comprising a number of unidimensional first-order competencies. The behavioural indicators for each of the nine PGLCQ subscales therefore necessarily had to be somewhat less homogenous than they would have been if they had been developed for unidimensional first-order competency subscales. Such a line of reasoning would, however, be false even though the conclusion may at times be true. The second-order competencies are not the aggregate or sum of all the first-order competencies. Rather the second-order competency represents the common source of systematic variance shared by a specific set of first-order competencies that causes the first-order competencies to correlate to some degree. The theme/themes characterising the common source of variance guided the development of the items for each second-order graduate leader competency.

Furthermore, in recognising that good scale construction is an “iterative process involving several periods of item writing, followed in each case by conceptual and psychometric analysis” (Clark & Watson, 1995, p. 311) the researcher erred on the side of “overinclusiveness” (Clark & Watson, 1995, p. 311) with regards to the number of items generated as “subsequent psychometric analyses can identify weak, unrelated items that should be dropped from the emerging scale(s) but are powerless to detect content that should have been included but was not” (Clark & Watson, 1995, p. 311). Items were scaled via the Likert method that approximates an interval level of measurement (Schmitt & Klimoski, 1991) and includes several points along a continuum that “anchors” various amounts or levels of the variable to be measured. Five-point Likert scales were utilised as these have been known to create the variance that is necessary for examining the relationships among items and scales and create adequate internal consistency reliability estimates (Lissitz and Green, 1975).

In addition to a ‘cannot rate’ category, the PGLCQ catered for five scale points anchored by the following descriptions: *well below standard* (1), *below required standard* (2), *satisfactory* (3), *above required standard*, and *well above required standard* (5).<sup>182</sup> Finally, the fact that the PGLCQ had to elicit ratings from multiple perspectives necessitated the researcher to develop two versions of the instrument – a self-report version and an ‘other-rater’ version. These two versions however, differed not in terms of the items included in each but rather in the way in which commonly included items were phrased. The self-report version was framed to elicit responses from a first-person perspective (i.e. the graduate him or herself) whilst the other-rater version was framed to elicit responses from a second person’s point of view (i.e. the graduate’s manager, mentor or programme head). Examples of items developed for the self-report experimental version of the PGLCQ are depicted in Figure 3.6 below.

Definitions	Well below standard	Below required standard	Satisfactory	Above required standard	Well above required standard	Cannot rate
 <b>DEVELOPS UNIT COMPETITIVENESS:</b> Develops and secures resources for the occupation of a morally superior, winning market position and its accompanying conversion process for effectively exploiting viable, eco-friendly and sustainable opportunities in the market.						
<b>A1: Resources</b>	I struggle to secure sufficient amounts of resources (i.e. materials, budget, equipment, etc.) for my team to function optimally.		I usually am able to secure just enough resources (i.e. materials, budget, equipment, etc.) for my team to function optimally.		I am very proficient at securing sufficient amounts of or even surplus resources (i.e. materials, budget, equipment, etc.) for my team to function optimally.	
	1	2	3	4	5	0
<b>A1: Strategy</b>	I consistently struggle to conceive of (business) strategies to put my team/unit in a competitive position in the market/organisation.		I am usually able to conceive of (business) strategies to put my team/unit in a competitive position in the market/organisation.		I regularly conceive (business) strategies that put my team/unit in a competitive position in the market/organisation	
	1	2	3	4	5	0

Figure 3.6. Likert scale format for experimental items in the PGLCQ that measures proficiency on the develops unit competitiveness second-order graduate leader competency

<sup>182</sup> The PGLCQ catered for a sixth scale point anchored by the description *cannot rate* because the electronic version of the PGLCQ created on Checkbox required participants to respond to every item. An item score of 6 was declared a user-defined missing value. See section 3.7.2.4 on Missing Values.

### 3.8 SAMPLING STRATEGY AND RESEARCH PARTICIPANTS

The target population in the current study was defined as South African graduate leaders participating in a graduate development programme offered by private sector organisations in South Africa. Including the whole target population in the study was not practically feasible. The only alternative was to select a sample from the target population. The logic of sampling in research thus involves the selection of a sub-group of the population that is representative of the target population of interest, allowing the researcher to utilise economies of scale in studying a smaller sub-group to gain insights about the parameters of the larger population from which it was drawn. The more representative the sample, the higher the level of confidence with which the researcher is able to generalise the results of the study to the target population, and the lower the representativeness, the more likely it will be that the external validity of the research will be questioned and criticised. Moreover, if the sample size is too low it will quite likely lack the precision necessary to provide reliable answers to research questions, while if too large, time and resources will unnecessarily be wasted for only minimal gains. Although there will be a degree of sampling error in most studies, the skill of effective sampling can thus be summarised as the employment of the appropriate methodologies in response to various situational demands in order to maximise the representativeness of the sub-group chosen and to minimise sampling bias.

Given the fact that non-probability samples cannot guarantee representativeness (Babbie, 2016), it was decided to utilise a probability<sup>183</sup> sampling technique for the present study, namely the two-stage cluster sampling with stratification (Babbie & Mouton, 2001) design which ensured equal probability for each element of the sampling population<sup>184</sup> to be included in the sample (Sweeney, 2013). This was an important choice as the study targeted the development of a generic graduate (leader) competency domain model and the findings from non-probability sampling studies cannot be generalised (Summers, 1991). In short, in two-stage cluster sampling with stratification, the (sampling) population of interest is divided into strata based on one or more characteristics of importance for the research. During the first stage of sampling, a predetermined number of primary sampling units (PSU) was therefore selected randomly with probability proportional to size from each stratum. During the second stage of sampling, a fixed number of final sampling units (FSU) was selected randomly from each primarily selected PSU (Babbie & Mouton, 2001). The number of FSUs sampled from each stratum was again determined via proportionality. The sampling population or sampling frame for the study was all organisations that are members of the South African Graduate Employers Association (SAGEA)<sup>185</sup> and the inherent heterogeneity of member organisations in terms of the type of business (i.e. different value chains and products/services) they each represent prompted the researcher to stratify the study population in terms of the *industries for which they employ graduates*.<sup>186</sup> Hence, SAGEA members such as Standard Bank, First National Bank and Investec were partitioned in the sampling frame as Graduate Banking, whilst SAGEA members like Webber Wentzel, and Werksmans Attorneys were partitioned as Graduate Legal, and so on. During the first stage of sampling, organisations were treated as PSU. Individual graduates on graduate programmes in the selected organisations were the FSU during the second stage of sampling.

---

<sup>183</sup> Representativeness is enhanced by probability sampling and allows generalisability and the use of inferential statistics (Babbie, 2016).

<sup>184</sup> The sampling population refers to those final sampling units (FSU) of the target population that have a non-zero probability of being selected.

<sup>185</sup> A non-ignorable sampling gap is thereby implied that compromises the representativeness of the sample to a degree despite the probability sampling procedure followed. However, although it is acknowledged that SAGEA member organisations are not the only organisations in South Africa that employ graduates, it can be argued that the SAGEA member organisations provide the best possible sampling frame for this study as they are the employers of choice among graduates, as a group employs by far the most graduates in the country, and they are the only group of organisations in the country that actually have specialised graduate development programmes in place.

<sup>186</sup> A list of the registered members of SAGEA is provided in Appendix C.

A second target population is thus relevant given the current study's use of subject matter experts in the Delphi technique and in the Critical Incident Technique. The second target population was defined as South African private sector managers that are experienced in and knowledgeable about graduate leaders participating in a graduate development programme offered by private sector organisations in South Africa. Again, it would be totally impractical to include the whole target population in the study. In line with the advice from Guest, Bunce and Johnson (2006) who suggest that a (minimum) sample of 12 participants is appropriate when working with a narrow research scope (i.e. graduate leadership (behavioural) performance) and with a homogenous population (graduate recruiters, managers and programme heads), 15 PSUs were randomly selected from the SAGEA member pool for participation in the **qualitative** part of the study<sup>187</sup> – i.e. to participate in the Delphi technique and the Critical Incident Technique. This guideline was followed as in the selection and sampling of research participants for **qualitative purposes** the aim is not necessarily to ensure *representativeness* (Neuman, 2003) of the population (i.e. among graduate recruiters, managers, or program heads in SAGEA organisations) under investigation as such, but validity in this context rather relates to the richness of the information extracted from the representatives selected for participation in the study (i.e. the extent to which the representatives provided usable, valid content for the development of the PGLCQ). In fact, the whole aim really is to select a biased sample that contains the most knowledgeable subject matter experts that are able and willing to generate a rich abundance of critical behavioural incidents and that are most eminently qualified to evaluate the connotative meaning attached to the graduate leader performance construct in terms of construct contamination and deficiency. The 'cases' themselves were therefore of no specific interest, only the conclusions and transfers that could be drawn from them (Flyvbjerg, 2001). For this reason, the researcher also took special care and effort to elicit and safely and anonymously secure a comprehensive dataset from the initial research participants (i.e. representatives of the randomly selected PSUs) through credulous listening, probing without making hasty assumptions and interpretations, and accurately documenting and keeping records of consistent or inconsistent features as patterns or themes (Labuschagne, 2003) as these emerged from contact sessions. In addition, as random samples that emphasise population representativeness (or the average case) do not necessarily produce the best sources of information on a phenomenon under investigation, the researcher reserved the option of adding further research participants from other SAGEA member organisations to supplement the content extraction exercise (e.g. targeting additional well-known experts in the field for deeper clarification) until he was convinced that satisfactory insights were obtained and the knowledge resources of the representatives of the SAGEA member pool was exhausted.

Furthermore, all representatives that participated on behalf of each SAGEA member organisation (or FSU) for this purpose was vetted and had to comply with the following inclusion criteria:

1. The individual had to represent a company that is a member of SAGEA;
2. The company they represent had to have employed at least 20 graduates every year, for the past 5 years and plan on continuing to do so for the near future;
3. The company they represent had to run a formal leadership acceleration programme for their graduates;
4. The individual had to have at least two years' experience working with, recruiting, developing, and/or managing graduates; and
5. If the participant was not in the best position to gauge the performance of graduates in the member organisation, they had to have access to people that would be able to do so on their behalf.

---

<sup>187</sup> The aims of the study necessitated two samples – one for validating the relevance of the nine extracted second-order leadership competencies and generating items for the PGLCQ, and the other for the actual testing of the structural competency domain model via LISREL.

While this approach sufficed for obtaining the content necessary for PGLCQ item generation, the use of structural equation modelling (SEM) for the testing/fitting of the current study's measurement and comprehensive LISREL models necessitated more stringent sampling requirements in accommodating this multivariate statistical analysis technique's positivist (Henn, Weinstein, & Foard, 2009) epistemological underpinning. Decisions governing the estimation of the appropriate sample size for this purpose involved the review of guidelines provided in the literature on: 1) the appropriate ratio to utilise between the number of observations to the number of parameters to be estimated in the study; 2) the statistical power yield required from the study's sample size; and 3) practical and logistical considerations pertinent to the study such as cost, time, the availability of suitable respondents and SAGEA members' willingness to commit large numbers of their graduate trainees to the research study.

Regarding the appropriate ratio between the number of observations to the number of parameters to be estimated in the study in sufficiently powering SEM procedures, the general consensus is that at the very least the sample size should not be less than the number of parameters to be estimated in a model,<sup>188</sup> and although the use of this is often discouraged (e.g. Iacobucci, 2010; Steiger, 2007), a benchmark of at least 200<sup>189</sup> observations is often suggested (Kelloway, 1998). Different authors also have varying opinions on the appropriate ratio of the number of observations to the number of parameters to be estimated for the testing of models, with Bentler and Chou (1987) recommending a ratio of between 5:1 and 10:1 and Jackson (2003b) more stringently suggesting a ratio of between 10:1 or 20:1. However, if the current study's measurement and comprehensive LISREL models are used for the calculation of the appropriate sample size for this part of the study, this requires the estimation of 216 freed parameters<sup>190</sup> and thus a sample of at least 1080 (and ideally 2160 or even 4320) if the guidelines of these authors are to be strictly followed.

The statistical power of the test of the hypothesis of close fit (i.e.  $H_{02}$ : RMSEA  $\leq$  .05) against the alternative hypothesis of non-close fit ( $H_{a2}$ : RMSEA  $>$  .05) represented a second consideration for the researcher in estimating the appropriate sample size for the quantitative part of the study. With some latitude of control over the current study's statistical power via sample size manipulation (given a set significance level) the researcher turned to available power guidelines designed to inform decisions on the appropriate sample size to utilise while controlling for Type 1 and 2 error. In investigating a case for exact fit null hypothesis of the PGLCQ model, where the population RMSEA value under  $H_a$  was set at .05, the degrees freedom 3879 and desired statistical power .80, a software computation (Preacher & Coffman, 2006)<sup>191</sup> recommended a minimum sample size of = 24.12 (or 25) units of observation. In investigating a case for close fit null hypothesis of the PGLCQ model, where the population RMSEA value under  $H_a$  was set at .08, the degrees of freedom 3879 and the desired statistical power .80, the Preacher and Coffman (2006) software computation recommended a minimum sample of  $n = 16.4$  (or 17 units of observation).

Ultimately with the 'high end' guideline of Bentler and Chou (1987) clearly setting too formidable a logistical challenge and the 'low end' guideline of Preacher and Coffman (2006), in turn, a too unambitious standard, the researcher had to factor in the option of fitting both the measurement and comprehensive LISREL models with tau-equivalent<sup>192</sup> constraints given the degree of accessibility that he had with graduate trainees in SAGEA member organisations, as well as the

---

<sup>188</sup> This leads to an *underidentified* model where a solution cannot be attained; cases where software packages usually print a message indicating there are negative degrees of freedom or that the model cannot be identified.

<sup>189</sup> Garver and Mentzer (1999) and Hoelter (1983) proposed that a 'critical sample size' of 200 provides sufficient statistical power for SEM procedures.

<sup>190</sup> i.e.  $\Lambda(90) + \Theta_8(90) + \Phi(9 \times 8/2) = 216$ .

<sup>191</sup> The authors' syntax in R is available at <http://www.quantpsy.org/rmsear/rmsear.htm>.

<sup>192</sup> A tau-equivalent model is one in which the lamdas are set equal to each other for each scale, intercepts are set equal to 0 over all scales and error variances are allowed to be freely estimated.

size of the overall study population<sup>193</sup> at his disposal in coming to a middle-ground solution. Hence, a final decision was taken to attempt to extract a sample of 300 observations for the testing of both the study's measurement and comprehensive LISREL models as this choice (and given that tau-equivalent constraints was imposed when fitting the models<sup>194</sup>) satisfied (or came critically close to) the requirements of most of the authors cited on the sample sizes necessary for sufficiently powering SEM procedures (Bentler & Chou, 1987).<sup>195</sup> This decision (and given that tau-constraints were imposed) at the same time ensured that the measurement and comprehensive LISREL models could both theoretically be more *overidentified* (i.e. even more 'knowns' or observations than 'unknowns' or parameters). Consequently, the same 15 SAGEA members that initially participated in the qualitative analyses conducted earlier (i.e. CIT and Delphi Method) was again contacted and requested to complete the 'other' version of the PGLCQ for 10 of their graduates<sup>196</sup> in an effort to get 150 responses (i.e. approximately 4% of the total number of graduate trainees employed by SAGEA members as reported in 2014). Each graduate that was rated by a contact person in a SAGEA member organisation was likewise requested to complete the 'self-report' version of the PGLCQ themselves, ultimately providing *dual-perspective* ratings for 150 graduates (or 300 observations in total).

### 3.9 STATISTICAL ANALYSIS

#### 3.9.1 EVALUATION OF STATISTICAL ASSUMPTIONS

##### 3.9.1.1 Variable type

A common occurrence in social research is the use of measurement instruments that require categorical responses from research participants (Cliff & Keats, 2005; Kampen & Swyngedouw, 2000). This phenomenon is rife in psychological research where constructs such as attitudes, perceptions or personality traits are frequently measured by making use of hierarchically numbered/ordered Likert scales (e.g. strongly agree, disagree, agree, strongly agree) or where some aspect of cognitive ability is measured by making use of assessments essentially requiring binary<sup>197</sup> (e.g. correct/incorrect) responses. They allow for a rank-order (i.e. 1<sup>st</sup>, 2<sup>nd</sup>, 3<sup>rd</sup>, etc.) to be established by which data can be sorted through relative, yet not *fixed* or *equidistant*, degrees of difference between response categories. For this reason, Likert scales' observed (measured) outcomes are strictly speaking associated with ordinal, rather than continuous data. This is problematic and formally inappropriate (Jöreskog, 1994) for Maximum Likelihood SEM analyses as the use of such data violates the continuous data assumption in the application of continuous normal theory Maximum Likelihood (ML) in the estimation of model parameters (Rhemtulla, Brosseau-Liard, & Savalei, 2012). Ideally, data derived from an ordinal scale thus should be analysed using estimation methods that are designed for use with such data such as the Weighted Least Squares (Jöreskog & Sörbom, 1996a) or Asymptotic Distribution Free (Browne, 1987) estimation of model parameters using the polychoric correlation and asymptotic covariance matrix.<sup>198</sup>

---

<sup>193</sup> According to SAGEA (2014), the total graduate trainee population in all of their member organisations only amounted to 4330 individuals by December 2014.

<sup>194</sup> It is acknowledged that the imposing of tau-equivalent constraints on the models constitute a compromise and that the ideal would have been to fit both models by way of the congeneric method (that allows tau to be estimated freely and these intercepts to vary over indicators) instead.

<sup>195</sup> If tau-equivalent constraints were to be imposed on both the measurement and comprehensive LISREL models then the amount of freed parameters would reduce from 216 to 135.

<sup>196</sup> Each representative was encouraged to delegate the completion of the questionnaires to colleagues in their organisations that have everyday contact with the graduates that were selected for participation in the study.

<sup>197</sup> Even when having to calculate a mathematical problem for instance, the participant would typically arrive only to the correct or incorrect (i.e. binary) conclusion.

<sup>198</sup> It is acknowledged that LISREL 9.3 now offers an alternative, more appropriate procedure based on adaptive quadrature for the analysis of ordinal data.



Nonetheless, in practice most researchers treat the output of Likert scales that have more than 4<sup>199</sup> categories as continuous data, and there is some evidence to suggest that in application this interpretation proves to be sufficiently 'safe' and not likely to have much practical impact on the results (e.g. Babakus, Ferguson, & Jöreskog, 1987; Dolan, 1994; Hutchinson & Olmos, 1996) of SEM analyses when data skewness and kurtosis are within 'reasonable' limits. Accordingly, it has been found that bias tends to diminish as the number of response categories in Likert scales increases, so much so that when the number of response categories reaches four or five, most studies find ML parameter estimates to be sufficiently accurate (Beauducel & Herzberg, 2006; Dolan, 1994; Johnson & Creech, 1983). Thus, for the purposes of fitting both the measurement and comprehensive LISREL models, all indicator variables<sup>200</sup> were treated as (approximate) continuous variables in the current study. This methodology was deemed appropriate as despite Likert scales often being associated with ordinal data, all items in the PGLCQ were measured utilising a 5-point scale<sup>201</sup> (Babakus et al., 1987; Hutchinson & Olmos, 1996; Johnson & Creech, 1983; Zimmerman & Zumbo, 1993;) and in line with acceptable contemporary protocol (Kinnear & Taylor, 1991), their outputs were subsequently treated at an interval level (Malhotra, 1996) of measurement.

### 3.9.1.2 Multivariate normality and estimation method

One of the main concerns when working with data in SEM procedures is whether the extracted sample under investigation permits one to hold the position that the indicator variable distribution follows a multivariate normal distribution in the parameter. This is important as the distribution of data in the population determines the proper estimation method to be used and the extent to which the estimates obtained from the most commonly used goodness of fit indices (e.g. those based on the chi-square statistic) can be regarded as trustworthy (Distefano, Jiang, Liu, & Shi, 2017). For example, if the multivariate normality requirement is met, the method of Maximum Likelihood (ML) estimation is the default method used to derive estimates for the freed model parameters (Kaplan, 2000) when analysing continuous data. ML estimators are asymptotically normally distributed (Heijmans & Magnus, 1986), which ensures that the ratio of parameters to their standard errors approximates a Z distribution. Moreover, if a model is correctly specified and the sample size sufficiently large, the ML estimator method produces parameter estimates that are asymptotically unbiased, consistent and efficient (Bollen, 1987; Schermelleh-Engel, Moosbrugger, & Müller, 2003). Consequently, the ML estimation method provides a formal statistical test of overall model fit for overidentified models that is reported to be quite robust over a variety of conditions and even when the assumption of normality is moderately violated (Diamantopoulos & Sigauw, 2000).<sup>202</sup> However, it is important to note that if a researcher heedlessly proceeds with this estimator method in the presence of excessive skewness and/or kurtosis in data,<sup>203</sup> it is probable that this could lead to biased standard error of parameter estimates and the inflation of the chi-square statistic with an increasing Type 1 error rate (Curran, West, & Finch, 1996).

For this reason, other estimator methods such as asymptotic distribution free (ADF) estimation methods (i.e. Weighted Least Squares (WLS) and Diagonally Weighted Least Squares (DWLS)) or

---

<sup>199</sup> Muthén and Kaplan (1985) suggest that an ordinal scale should contain at least 5 or more response categories to approximate an interval scale.

<sup>200</sup> These refer to the 90 indicator variables utilised in fitting both the measurement and comprehensive LISREL models.

<sup>201</sup> Although the use of more points on the scales would have mitigated standardised coefficient attenuation even more, the greatest attenuation of correlations occurs when using fewer than 5 points (Bollen 1989) and this threshold was therefore deemed sufficient for use in the current study.

<sup>202</sup> Browne (1987) has even demonstrated the ML estimators maintain their desirable asymptotic properties even with non-normal data as long as there is no excess multivariate kurtosis.

<sup>203</sup> Even so, Diamantopoulos and Sigauw (2000) argue that ML is rather robust against moderate violations of the normality assumption as well, if the sample size in use comprises 100 or more observations (Anderson & Gerbing, 1988; Steenkamp & van Trijp, 1991). This is why for practical purposes, if "the distributions of the sample variables are not wildly non-normal" (Barnes, Cote, Cudeck, & Malthouse, 2001, p. 80); ML would still probably be sufficiently reliable for use in most situations.

Robust Maximum Likelihood (RML) in combination with Satorra and Bentler's (cited in von Eye & Clogg, 1994) extension that provides the correctly scaled chi-square statistic, was developed that are less distributionally dependent and more *appropriate* for use in situations where the assumption of multivariate normal distribution does not hold.<sup>204</sup> These are used to correct for non-normal data and are theoretically considered more correct even though it has been proven that some do not necessarily yield better performances (Baumgartner & Homburg, 1996). Regardless, the RML-Satorra-Bentler (cited in Clogg & von Eye, 1994) estimator comes as the most highly recommended (Mels, 2003) option as simulation studies have consistently demonstrated its superiority over least squares estimators (Boomsma & Hoogland, cited in du Toit, Cudeck, & Sörbom, 2001) in dealing with different sample sizes and degrees of non-normality (Li, 2014), and as is evidenced in its generation of less biased standardised errors when dealing with non-normally distributed data.

The choice, however, of which estimator method to use and the exact threshold indicating when data non-normality becomes practical non-normality in terms of its effects on coefficients and their significance (Bentler, 1989) often remains unclear. Moreover, survey data sets are almost always non-normal<sup>205</sup> with the default estimator in most statistical packages being ML, begging the question as to whether it is vital to inspect data properties before selecting an estimator method, especially since ADF (type) estimators do not really provide a practical alternative for use due to the extremely large samples they require to produce reliable weight matrices (McDonald & Ho, 2002). However, in conforming to the proper convention by relying on expert advice from Jöreskog and Sörbom (1996b), the distributional properties of the current study's sample was nonetheless tested by way of PRELIS 2 (companion software for LISREL) to obtain Mardia's statistic, an omnibus coefficient describing the skewness and kurtosis of the sample data.<sup>206</sup> The following scenarios were possible and the logic in appropriately dealing with each as follows:

- If the null hypothesis that the indicator variable distribution in the parameter follows a multivariate normal distribution was not rejected, the default estimation technique of *Maximum Likelihood Estimation* was retained in the research protocol;<sup>207</sup>
- If the null hypothesis that the indicator variable distribution in the parameter follows a multivariate normal distribution was rejected due to a statistically significant chi-squared test statistic ( $p < .05$ ), the researcher attempted to normalise the data through the normalisation of item (or item parcel) indicators. The success of this attempt was analysed by testing the null hypothesis that the normalised indicator variable distribution follows a multivariate normal distribution in the population (Burger, 2012; Chikampa, 2013);
- If this attempt still failed, there was no other option but to utilise the *Robust Maximum Likelihood* estimation method (Mels, 2003).

### 3.9.1.3 Missing values

Given the fact that missing data is a frequent occurrence in quantitative social research (Brunton-Smith, Carpenter, Kenward, & Tarling, 2012) and great care was taken to estimate and collect the appropriate sample size for the current study in sufficiently powering its SEM procedures, the

<sup>204</sup> These are reported to work better especially under conditions of severe non-normality (Bentler, 2006).

<sup>205</sup> "Variables are rarely normally distributed... Probably in strict terms the question is a non-issue from the beginning: virtually no variable follows the normal distribution" (Barnes, et al., 2001, p. 80).

<sup>206</sup> A coefficient of less than 5 is sufficient to assume that the multivariate normality assumption is met (Bentler, 2005).

<sup>207</sup> A useful approach if this occurs is to estimate the model a second time using an estimator that is less distributionally dependent like RML. If associations that are significant with ML are not significant with RML (or vice versa), this would suggest that the data is practically non-normal.

manner in which the researcher dealt with the problem of missing values (i.e. no data recorded<sup>208</sup> for one or more items on the PGLCQs completed and returned by graduate trainees and their managers) also needs to be addressed. A failure to properly manage missing values could have undone this careful planning, offset the considerable time invested in data gathering and confounded any statistical analyses and conclusions that followed from this. For example, and if this indeed was a severe occurrence, simply omitting the records of research participants who did not respond to one or more items in the questionnaire (i.e. using listwise deletion) would have drastically reduced the sample size and its power, to the detriment of the study. On the other hand, the strategy of retaining all incomplete records in the statistical analysis in an attempt to maximise the sample yield by computing correlations for as many cases as values was available (and excluding records from computations where data values were missing altogether (i.e. *pairwise deletion*)), could have led to problems as the parameters of the model would then have stood on different sets of data and different statistics (i.e. different sample sizes and standard errors) and likely would have produced an intercorrelation matrix that was not positive definite (i.e. all eigen values not  $\geq 0$ ).<sup>209</sup> Substituting missing values simply with the means of respective item sets, a strategy that could be considered for countering the problem of missing values in general by substituting missing values with surrogate values of central tendency, was likewise deemed unsuitable as in severe cases this approach would have had the effect of ‘smoothing out’ any variation in the data to an undesirable extent (Pigott, 2001).

Thus, consistent with the opinions of other authors who regard this strategy as the most promising of the current missing data methods (e.g. Pigott, 2001, Rubin, 1996), a decision was made to utilise the *multiple imputation* approach in the handling of missing values. Operating on the assumptions that any missing values occurred at random,<sup>210</sup> that the observed variables were continuous and that they followed a multivariate normal distribution pattern, this functionality allowed the estimation of missing values derived for all cases in the original sample to represent the observed information in a way so as to make “it amenable to valid analysis using complete-data tools” (Rubin, 1996, p. 479). As opposed to the utilisation of simply the means of respective item sets or similar strategies for this purpose, however, the researcher utilised the LISREL multiple imputation functionality to a) simulate several possible values for each missing observation in the data based on its distribution (i.e. multivariate normal) in order to obtain a set of at least three parallel completed data sets, and b) use standard analysis procedures to analyse each completed data set and then combine these estimates to obtain the multiply-imputed estimates (Pigott, 2001).

Alternatively, if the data set met the requirements of multivariate normality, the option of imputation by matching was also available to the researcher whereby missing values could be substituted for real values as derived from cases with similar response patterns (Jöreskog & Sörbom, 2003; Myburgh, 2013). The disadvantage of the imputation by matching procedure is that it does not necessarily impute missing values for all cases with missing values. Those cases for which imputation failed are accordingly deleted from the imputed data set. Regardless, the advantage of utilising imputation in general is that it preserves all (or most) of the sampled cases and statistical power, which is particularly useful given the current study’s reliance on and sensitivity to sample size. While the optimal scientific ideal undoubtedly still remains the avoidance of missing data altogether, unfortunately the artificial creation of data for

---

<sup>208</sup> As the electronic versions of the PGLCQ were created on *Checkbox* that ‘forced’ participants to respond to all questions, missing values in this context would refer to a situation where participants selected the ‘cannot rate’ category on one or more of the PGLCQ’s items.

<sup>209</sup> This could have likely prevented any further analyses.

<sup>210</sup> Missing data is considered *missing at random* (MAR) if the probability for a data point to be missing is not related to the variable on which missingness occurred, but it is related to some of the observed data. Missing data is considered *missing completely at random* (MCAR) if the probability for a data point to be missing is not related to the variable on which missingness occurred or any variable in the data set. Missing data is considered *missing not at random* (MNA), if there is a relationship between the probability of a missing value on a specific variable and the level of that variable.

unobservable responses will always erroneously increase parameter precision in a way that can bias hypothesis testing. However, multiple imputations address this problem as the use thereof typically results in more unbiased, honest estimates of the standard errors, which reflects the inherent uncertainty that derives from missing responses that inevitably occurs in many research studies.<sup>211</sup>

### 3.9.2 ITEM AND DIMENSIONALITY ANALYSIS

Item and dimensionality analysis were employed to assist the researcher in producing a final item set that constituted a parsimonious, pure and comprehensive measure of each of the psychological constructs (i.e. the second-order graduate leader competencies) included in the PGLCQ. The item and dimensionality analyses of the sample response set iteratively targeted the elimination of items that detracted from, rather than contributed to the PGLCQ's ability to reliably and validly measure the constructs it purported to measure. Consequently, in combination both analyses focused on investigating the reliability of the items as indicators of each latent variable included in the PGLCQ, determining the sensitivity or the discrimination ability of each item included in the PGLCQ's subscales, and evaluating the unidimensionality – or the extent to which each item in a given scale measured a single common underlying latent variable as it was designed to do.

Regarding the reliability of the items included in the PGLCQ, the aim was to get as close as possible to a situation where graduate trainees that were identical to each other in terms of their mastery of the second-order competencies included in the PGLCQ achieved the same ratings on all of the corresponding subscales, while those graduate trainees that were completely different from each other on the same criteria achieved (correspondingly) completely different scores. In many analyses that scrutinise the reliability of measurement scales the Cronbach alpha (internal) reliability coefficient is calculated as part and parcel of the standard item analysis procedure and used as a definitive indicator of subscale reliability. However, as Cronbach alpha assumes that a subscale is unidimensional,<sup>212</sup> satisfies the assumptions of essential tau equivalence<sup>213, 214</sup> that the data under investigation is multivariate normal in nature,<sup>215</sup> and these assumptions might not (all) hold true with regards to the subscales investigated in the current study, the researcher decided not to use Cronbach alpha as a *definitive indicator* of reliability when reporting the item analysis results.<sup>216</sup> Instead, the researcher opted to report the reliability statistics only after completion of the dimensionality analysis and to also report, assuming that the unidimensionality assumption had been corroborated, the McDonald omega that makes the less stringent

<sup>211</sup> Moreover, the researcher had the option of repeating item and dimensionality analyses, originally performed on the data set with missing values, with the imputed data set to evaluate if this design intention succeeded the impact of the imputation.

<sup>212</sup> If the assumption of unidimensionality is violated, Sijtsma (2009) and Raykov (2001) have demonstrated that  $\alpha$  may be overestimated.

<sup>213</sup> The essentially tau-equivalent model requires the elements of  $\Lambda^x$  to be equal across the items of each subscale but allows the elements of  $\tau$  and  $\Theta_{\delta}$  to be freely estimated. "Essential tau-equivalence assumes that each item measures the same latent variable, on the same scale, but with possibly different degrees of precision (Raykov, 1997a). Again, as with the tau-equivalent model, the essentially tau-equivalent model allows for possibly different error variances" (Graham, 2006, p. 934). The essentially tau-equivalent measurement model therefore requires that the regression of item  $X_i$  on the latent graduate leader competency  $\xi_j$  are the same in terms of slope but not in terms of intercept or error variance across the indicators of the same (unidimensional) latent variable.

<sup>214</sup> If the assumption of tau-equivalence is violated, Raykov (1997b) and Graham (2006) suggest that  $\alpha$  may be underestimated.

<sup>215</sup> According to Sheng and Sheng (2012), a negative bias is produced in coefficient  $\alpha$  when data distributions are skewed and/or leptokurtic.

<sup>216</sup> This does not mean that the researcher did not use Cronbach Alpha as an additional, informal indicator of scale reliability during item analysis at all. The researcher felt that there was still value in consulting the "Cronbach's Alpha if deleted" output from SPSS in order to assist in making decisions regarding the suitability of retaining or removing certain subscale items that were regarded as potentially problematic.

assumptions that the underlying measurement model is congeneric.<sup>217</sup> On the suggestion of Nunnally (1978), the reliability coefficient requirement for the unidimensional PGLCQ subscales was set at between .70–.80. Thus, for PGLCQ subscales where this requirement was met, the researcher concluded that the items included in that subscale could be trusted as a composite indicator that consistently measured/reflected the same source of systematic variance (but not necessarily the second-order competency the scale intended to reflect). A positive/favourable finding on the item analysis therefore cannot be definitively interpreted that the design intention underpinning the PGLCQ succeeded. It is true that if the underlying design intention had succeeded that the item analysis would return positive findings. Positive findings in the item analysis therefore only permit the conclusion that the design intention survived an opportunity to be refuted. Negative findings in the item analysis, however, permit a more definitive conclusion that the design intention did not succeed.

In the case of all subscales, the researcher consulted the item statistics output to identify questions that could be discarded in fine-tuning that particular scale's internal consistency. The screening of the items of all the subscales involved the investigation of the following classical measurement theory item statistics: item means, item standard deviations, inter-item correlations, corrected item-total correlations, squared multiple correlations when regressing each item on the remaining items of the scale, scale reliability when item deleted, and scale variance when item deleted. Items were flagged as problematic if the item mean was extremely high or low, if the item standard deviation was an outlier in the item standard deviation distribution to the lower end of the distribution, if an item consistently correlated lower with the remaining items of a scale (or consistently correlated high negatively with the remaining items of the scale),<sup>218</sup> if a corrected item-total correlation was an outlier in the corrected item-total correlation distribution to the lower end of the distribution, if a squared multiple correlation was an outlier in the squared multiple correlation distribution to the lower end of the distribution, if the scale reliability (Cronbach alpha) increased substantially upon deletion of an item, and the scale variance only decreased marginally (or even increased) upon deletion of an item.

Further, the design intention of the PGLCQ was that the nine subscales would each reflect a unidimensional latent variable (i.e. second-order graduate leader competency) and that the items included in each respective subscale would operate as independent stimulus sets that could draw out responses to be used as accurate indicators of the level of research participants' standing on each of these latent variables. To test these assumptions relating to item validity and discrimination ability, the dimensionality of each of the nine subscales of the PGLCQ were investigated by using confirmatory factor analysis (CFA) using LISREL 8.8. The design intention to develop nine unidimensional subscales for the PGLCQ implies nine single factor measurement model hypotheses. The CFA assisted in directly testing whether these hypotheses were able to satisfactorily account for the observed covariance between the items comprising each subscale. If the single factor model fitted at least closely the statistical significance of the factor loadings were evaluated, and if statistically significant, the magnitude of the loadings was evaluated. Thus, CFA was employed to assist the researcher to: a) evaluate the assumptions that the items assigned to each subscale measured a single underlying factor; b) to evaluate the success with which each item measured the specific latent variable it was meant to represent; and c) to remove items that

---

<sup>217</sup> The congeneric model allows the elements of  $\tau$ ,  $\Lambda^X$  and  $\Theta_{\delta}$  to be freely estimated across the items of each subscale. "The congeneric model assumes that each individual item measures the same latent variable, with possibly different scales, with possibly different degrees of precision, and with possibly different amounts of error (Raykov, 1997a). Whereas the essentially tau-equivalent model allows item true scores to differ by only an additive constant, the congeneric model assumes a linear relationship between item true scores, allowing for both an additive and a multiplicative constant between each pair of item true scores" (Graham, 2006, p. 935). The congeneric measurement model therefore assumes that the regression of item  $X_i$  on latent graduate leader competency  $\xi_j$  differs in terms of intercept, slope and error variance across the indicators of the same (unidimensional) latent variable.

<sup>218</sup> In the case of an item consistently correlating high negatively with the remaining items of a scale it suggests that the item responses have been inappropriately coded.

had inadequate factor loadings. For the purposes of the current study, the assumption of unidimensionality was supported if a single factor measurement model fitted the subscale data, the (unstandardised) factor loadings were statistically significant ( $p < .05$ ), (completely standardised) factor loadings of greater than .50 ( $\lambda_{ij} \geq .50$ ) were observed, and the measurement error variances were statistically significant ( $p < .05$ ) but small. If the design intention underpinning the PGLCQ to measure nine specific second-order graduate leader competencies through the specific sets of items assigned to each subscale succeeded, a single-factor factor measurement model would fit for each subscale with items loading statistically significant ( $p < .05$ ) and high on the single factor, along with a small percentage of large residual covariances and statistically significant ( $p < .05$ ) but small measurement error variances. Such a finding would point to the fact that responses to all the items of a scale are determined by a unidimensional systematic source of variance. Such a finding cannot, however, be definitively interpreted as evidence that the items assigned to each subscale of the PGLCQ have successfully measured the nine specific second-order graduate leader competencies as they were constitutively defined. Again, the only permissible conclusion in such a case is that specific PGLCQ subscales measure specific second-order graduate leader competencies carrying specific connotative meanings, have successfully survived an opportunity to be refuted.

In the case where the single-factor measurement model did not fit the subscale data, exploratory factor analysis with oblique rotation was performed using principal factor analysis (PAF) via SPSS 26. The resultant factor structure was then evaluated by inspecting the percentage of large residual correlations. If this percentage exceeded 30% an additional factor was extracted. The identities of the extracted factors were inferred by identifying the common theme shared by the items that loaded on each factor. The factor fission was regarded as meaningful if the inferred factor identities made conceptual sense, if the extracted factors did not correlate excessively high and if the distinction between the subtle facets of the original latent graduate leader competency held practical formative feedback value. If the factor fission was regarded as meaningful a multi-factor first-order measurement model was fitted. If this model fitted at least reasonably well a second-order measurement model was fitted. The statistical significance of the indirect effect of the second-order factor on the subscale items was then evaluated by translating the SIMPLIS syntax to LISREL syntax and using the AP and CO commands to calculate the indirect effects. If the indirect effects that the second-order factor exerts on the subscale items were found to be statistically significant it was concluded that, in the interim, before extending the subscale, the items may be used to calculate a dimension score as a measure of the second-order factor.

In the case of factor fission, given that the multi-factor first-order measurement model fitted at least reasonably well, the Cronbach alpha and McDonalds's omega were not calculated. Rather the Stratified alpha and the Multidimensional omega were calculated via specially written Excel macros.

If the multi-factor first-order measurement model fitted poorly the possibility that a bifactor model (Reise, 2012) might improve the model fit was investigated by examining the modification indices calculated for the off-diagonal of the measurement error variance-covariance matrix  $\Theta_{\delta}$ . If numerous statistically significant ( $p < .01$ ) modification index values would exist for the covariances between the measurement error terms  $\delta_i$  currently constrained to zero, this would suggest the presence of a systematic source of variance that affects most subscale items but that the current measurement model fails to acknowledge. This omitted systematic source of variance was then modelled by adding a broad, general factor to the measurement model, on which all the subscale items loaded<sup>219</sup>.

---

<sup>219</sup> It is acknowledged that the presence of numerous statistically significant ( $p < .01$ ) modification index values that exist for the covariances between the measurement error terms  $\delta_i$  that are currently constrained to zero is not the only justification of a bifactor model. A statistically significant ( $p < .05$ ) and substantial correlation between the first-order factors would also

In the case of factor fission, given that the multi-factor first-order measurement model fitted poorly but a bifactor model fitted at least reasonably well, the Cronbach alpha and McDonald's omega were not calculated. Rather the Multidimensional omega, but not the Stratified alpha, was calculated via a specially written Excel macro.

In the current study, even though less emphasis was placed on the reliability statistics, item analysis was nonetheless still performed prior to performing the exploratory factor analysis. It is acknowledged that this is to some degree a debatable decision. In critique of this decision, one could argue that the item analysis as a whole, and not only the Cronbach alpha calculated by default as part of the item analysis, assumes unidimensionality. Viewed from this perspective, it would therefore have made more sense to have first evaluated the unidimensionality of each subscale, and in the case of meaningful factor fission, redirect the item analysis at the unidimensional subfactors that emerged. In defence of the decision, it could be argued that one or two poor items could result in the extraction of spurious factors. In addition, it could be argued that the presence of multiple factors will reveal itself in the item analysis through the persistent emergence of new problematic items upon deletion of previous problematic items. In such an eventuality, the item analysis would be terminated to follow up on the suspected factor fission via exploratory factor analysis. The current study would therefore argue that it does not really matter that much whether the dimensionality analysis follows on the item analysis or vice versa. If approached appropriately, the eventual verdict should be the same irrespective of whether the analysis set off with item analysis or with exploratory factor analysis.

### 3.9.3 EVALUATION OF MODEL FIT

While the researcher already proceeded in a manner that reflected the fact that *specific hypothesis* existed about the number of latent factors and the relations between the latent factors and observed variables previously when performing item and dimensionality analyses for purification purposes, the construct validation of the PGLCQ also necessitated the fit of both the current study's measurement and comprehensive LISREL models respectively, and in a sequential format. The evaluation of the current study's measurement model fit ensued by way of a CFA that was employed to confirm that the PGLCQ's items as indicators of second-order graduate leader competencies appropriately sorted themselves into identifiable factors corresponding to how the researcher conceptually linked these to the latent variables. "When a CFA is conducted, the researcher uses a hypothesised (confirmatory) factor model to estimate a population covariance matrix that is compared with the observed covariance matrix. Technically, the researcher wants to minimise the difference between the estimated and observed matrices" (Schreiber, Nora, Stage, King, & Barlow, 2006, p. 325) and report this discrepancy (and hopefully a positive result) through an appropriate combination of goodness of fit indices (See section 3.9.3.1 for more information on what constitutes good fit).

The fact that the PGLCQ is a multi-rater questionnaire in which ratings are obtained from the graduate and from their immediate superior, held implications for the manner in which the PGLCQ measurement model was specified. In the case of a single-rater questionnaire, and in which data had been obtained from a single group on a set of latent variables, the measurement model is specified by equation 3.1:

$$\mathbf{X} = \Lambda\boldsymbol{\xi} + \boldsymbol{\delta} \text{-----} [3.1]$$

where:

- $\mathbf{X}$  is a 90x1 column vector of observed item scores;

---

suggest a systematic source of variance shared by the first-order factors and their items. The addition of a general factor to the model would then, however, not improve the fit of the model but would reduce the inter-first-order factor correlations.

- $\Lambda^x$  is a 90x9 factor matrix of factor loadings describing the slope of the regression of  $X_i$  on  $\xi_j$ ;
- $\xi$  is a 9x1 column vector of second-order latent graduate leader competencies;<sup>220</sup> and
- $\delta$  is a 90x1 column vector of measurement error terms representing the combined effect of random measurement error and systematic non-relevant error influences.

Equation 3.1 does not fully specify the typical single group, single rater, first-order measurement model. Two additional matrices need to be specified. Typically, the variance-covariance matrix  $\Theta_\delta$  that describes the variance in the measurement term  $\delta_i$  and the covariance between the error terms  $\delta_i$  and  $\delta_j$  is defined as a diagonal matrix in which the off-diagonal covariance terms are set to zero. In addition, the variance-covariance matrix  $\Phi$  that describes the variance in the latent variable  $\xi_i$  and the covariance between the latent variables  $\xi_i$  and  $\xi_j$  is defined as a full matrix in which the main diagonal variance terms and the off-diagonal covariance terms are freed to be estimated. Typically, however, in a single-group study  $\Phi$  is produced as a standardised matrix in which the main diagonal is fixed to 1.

According to equation 3.1 the responses of participant  $q$  to item  $X_i$  is due the standing of participant  $q$  on the latent variable  $\xi_i$  that item  $X_i$  was earmarked to reflect, the slope of the regression of  $X_i$  on  $\xi_i$  and the random and systematic measurement error associated with  $X_i$  for participant  $q$ . In the context of this study however, equation 3.1 does not appropriately model the mechanism that produced the response of participant  $q$  to item  $X_i$  in the PGLCQ. Neither does it appropriately model the mechanism that produced the covariance between items  $X_i$  and  $X_j$  in the PGLCQ. The PGLCQ is a multi-rater questionnaire in which the same graduate is rated on nine second-order latent graduate leader competencies by a number of different raters that differ in the perspective from which they have observed the individual. It therefore was argued that the score that rater  $q$  assigns on item  $i$  was an expression of the graduate leader's standing on the latent competency item  $X_i$  was designed to measure ( $\xi_i$ ), the perspective from which the graduate leader was rated (i.e. self versus superior versus peer) and measurement error  $\delta_i$ . It was, moreover, argued that the standing on the latent competency item  $X_i$  was designed to measure ( $\xi_i$ ) was determined by the graduate leader rated.

It was consequently argued that the model of the psychological mechanism that has produced the observed inter-item variance-covariance matrix needs to formally acknowledge the role of the latent graduate leader competencies (and thus the graduate leader being rated), the perspective from which ratings were made, and measurement error.<sup>221</sup> More specifically the current study proposes that equation 3.2 more appropriately models the psychological mechanism that generated the observed PGLCQ inter-item variance-covariance matrix (given that multi-rater data had been collected) than the model described by equation 3.1. Equation 3.2 represents the confirmatory factor-analytic interpretation (Dumenci, cited in Brown & Tinsley, 2000; Goffin & Jackson, 1992; Marsh, & Grayson cited in Hole, 1995) of the thinking underpinning a Multitrait-Multirater (MTMR) matrix derived from the Multitrait-Multimethod (MTMR) matrix approach proposed by Campbell and Fiske (1959) for the investigation of the convergent and discriminant

---

<sup>220</sup> Despite the fact that the latent variables conceptually are latent second-order graduate leader competencies the measurement model is specified as a first-order measurement model. This is necessitated by the fact that the items of the PGLCQ were not written to explicitly measure the first-order competencies.

<sup>221</sup> Initially, it was erroneously argued that this means that graduate leaders needed to be formally modelled as a formative indicator variable (along with a formative rater indicator variable in a Multiple Indicator Multiple Indicator Cause (MIMIC) model). This line of reasoning assumed a 2nx90 data set in which each line represents a graduate leader either rated by themselves or an other-rater, and each column represents an observed variable; 90 item responses, a nominal graduate leader variable and a nominal rater variable. Modelling a formative graduate leader indicator variable that affect the nine latent second-order graduate leader competencies constitutes a tautological hypothesis, however, that makes little sense. The nine latent graduate leader competencies already represent the graduate leaders.



validity of particular measures (a CFA model with correlated competencies and correlated raters (CFA-CCCR)) (Marsh & Grayson, cited in Hole, 1995):

$$\mathbf{X} = \Lambda^x \boldsymbol{\xi} + \boldsymbol{\delta} \text{-----} [3.2]^{222}$$

where:

- $\mathbf{X}$  is 180x1 vector of observed variables with  $X_i S_i$  representing the graduate leader's self-rating response to item  $i$  and  $X_i O_i$  representing the other-rater's response to item  $i$ ;
- $\Lambda^x$  is a 180x11 factor loading matrix describing the slope of the regression of  $X_i$  on  $\xi_j$ ;
- $\boldsymbol{\xi}$  is a 11x1 column of exogenous latent variables where  $\xi_1 - \xi_9$  represent the nine latent second-order graduate leader competencies,  $\xi_{10}$  represents a self-rating (method) factor and  $\xi_{11}$  represents an other-rater (method) factor;
- $\boldsymbol{\delta}$  is a 180x1 column vector of measurement error terms.

To fully specify the multi-rater CFA PGLCQ model the variance-covariance matrices  $\Phi$  and  $\Theta_{\delta}$  also need to be specified.  $\Theta_{\delta}$  is a 180x180 diagonal matrix reflecting the assumption that the measurement terms contaminating the PGLCQ items were uncorrelated. In  $\Phi$  the main diagonal is fixed to 1 and all off-diagonal elements freed to be estimated but for  $\phi_{10,1}, \phi_{10,2}, \phi_{10,3}, \phi_{10,4}, \phi_{10,5}, \phi_{10,6}, \phi_{10,7}, \phi_{10,8}, \phi_{10,9}, \phi_{11,1}, \phi_{11,2}, \phi_{11,3}, \phi_{11,4}, \phi_{11,5}, \phi_{11,6}, \phi_{11,7}, \phi_{11,8}$  and  $\phi_{11,9}$  to reflect the assumption that the latent competencies are uncorrelated with the rater latent variables (Goffin & Jackson, 1992; Marsh & Grayson, cited in Hole, 1995). Marsh & Grayson (cited in Hole, 1995, p. 181) in this regard remark:

The constraint seems to be routinely applied to avoid technical estimation problems and to facilitate decomposition of variance into trait and method effects, not because of the substantive likelihood or empirical reasonableness.

An alternative model has been proposed by Marsh (1989) who acknowledges the presence of method effects by allowing the measurement errors associated with the indicator variables to be correlated. The CFA model with correlated competencies and correlated measurement error terms (or uniqueness) (CFA-CCCU) (Marsh & Grayson, cited in Hole, 1995) for the PGLCQ is shown as Equation 3.3:

$$\mathbf{X} = \Lambda^x \boldsymbol{\xi} + \boldsymbol{\delta} \text{-----} [3.3]$$

where:

- $\mathbf{X}$  is 180x1 vector of observed variables with  $X_i S_i$  representing the graduate leader's self-rating response to item  $i$  and  $X_i O_i$  representing the other-rater's response to item  $i$ ;
- $\Lambda^x$  is a 180x1 factor loading matrix describing the slope of the regression of  $X_i$  on  $\xi_j$ ;
- $\boldsymbol{\xi}$  is a 9x1 column of exogenous latent variables where  $\xi_1 - \xi_9$  represent the nine latent second-order graduate leader competencies;
- $\boldsymbol{\delta}$  is a 180x1 column vector of measurement error terms.

$\Theta_{\delta}$ , now is a 180x180 matrix in which the measurement error terms associated with item responses provided by the self-rater are allowed to correlate as well as those provided by the other-rater. Lance, Noble and Scullen (2000) indicate that the model described by equation 3.3 often returns convergent and admissible solutions when the conceptually more convincing model described by equation 3.2 does not. They however, recommend that due to substantive shortcomings<sup>223</sup> of the correlated error model the CT-CM model be regarded as the generally

<sup>222</sup> Equation 3.2 assumes a nx180 data set in which each row represents one of n graduate leaders. Each column represents an observed variable, 90 self-rater responses to the PGLCQ items and 90 other-rater responses to the PGLCQ items.

<sup>223</sup> The problem that Lance et al. (2000) has with the correlated uniqueness model is that it is no longer possible to separate the systematic rater effects in the measurement error associated with the response of rater  $i$  to item  $j$  ( $\delta_{ij}$ ) from other

preferred model and that the CU model be invoked only when the CT-CM model fails to return an admissible solution. The proposed multi-rater PGLCQ measurement model is depicted as a path diagram in Figure 3.7.

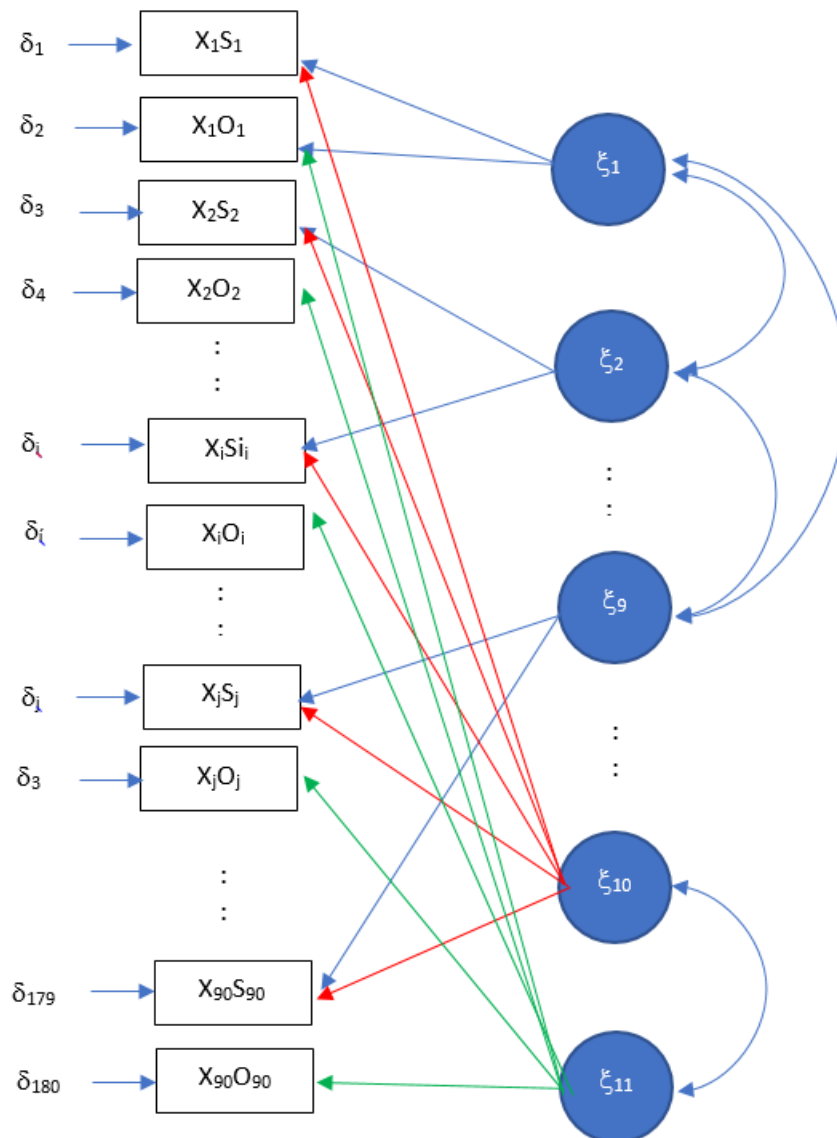

Figure 3.7. The multi-rater CFA (CCCR) PGLCQ model<sup>224</sup>

Kenny and Kashy (1992) and Marsh and Grayson (cited in Hole, 1995) assert that the CFA-CCCR measurement model implicitly formed the conceptual base of Campbell and Fiske's (1959) analysis of the construct validity of a measure in terms of Kenny and Kashy's (1992) validity, convergent validity and method effects that they chose to capture in the form of a Multitrait-Multimethod (MTMM) matrix. The Multitrait-Multirater (MTMR) matrix approach based on the

---

systematic and random error influences. There is also a tendency for positive bias to be introduced in the estimates of the proportion of item variance due to a specific trait as a result of the specification error caused by the failure to formally model the method effects.

<sup>224</sup> In this figure, the intercepts between  $\xi_1$  and  $X_{1S1}$  and  $X_{1O1}$  up to  $X_{10S10}$  and  $X_{10O10}$  are correct (and visible) while the intercepts between the other Etas (up to Eta 9) have been purposefully excluded to save space. The relations between Etas 2 to 9 and their respective item sets (self ratings and other ratings) however, are implied to exist in this model and to operate on the same logic as those depicted for Eta 1.

MTMM matrix proposed by Campbell and Fiske (1959) for the investigation of the convergent and discriminant validity of a particular measure assumes a  $t \times t$  correlation matrix consisting of the intercorrelations of the total scores obtained for  $t$  latent variables via  $r$  raters. The general form of the MTMM matrix is illustrated in Figure 3.8.

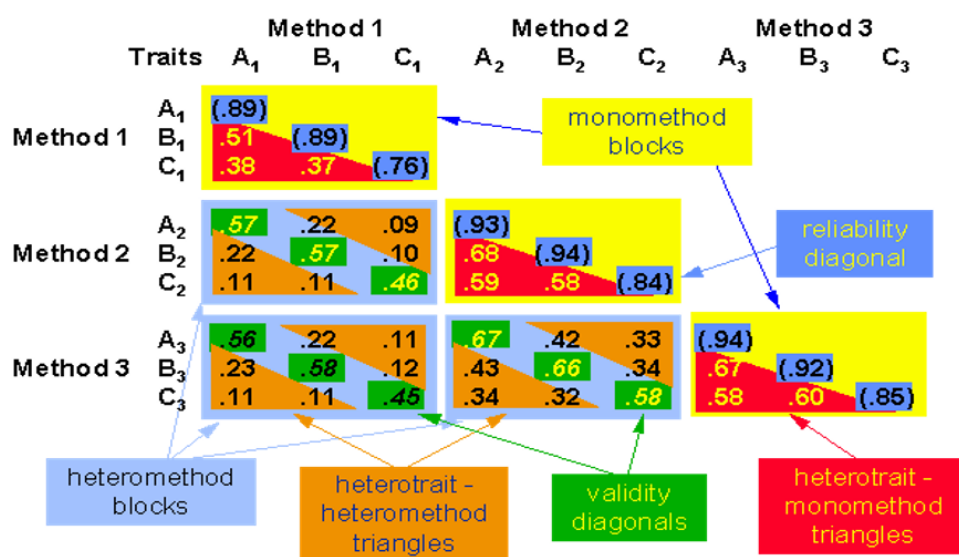

Figure 3.8. An illustrative MTMM matrix. Copied from Research Methods Knowledge Base. The multitrait-multimethod matrix. Retrieved from <http://www.socialresearchmethods.net/kb/mtmmmat.php>.

Campbell and Fiske (1959, pp. 82–83) suggested four criteria by which to evaluate MTMM matrices:

- Reliability coefficients in the main diagonal should consistently be the highest in the matrix.
- Correlations between the same construct measured by different methods should be high [convergent validity].
- Correlations between the same constructs measured by different methods should be higher than correlations between different constructs measured by the same method [discriminant validity] and by different methods.
  - Correlations in a validity diagonal in a specific heteromethod block should therefore be higher than [a] the correlations in the relevant heterotrait-monomethod triangles, and [b] the correlations in the same row and same column in that block [heterotrait-heteromethod triangles].
  - The correlation between two constructs measured by two different measures should therefore be lower than the correlation between the two constructs when measured with the same method and the correlation between the same construct measured by different methods should be higher than the former two types of correlations.
- The patterns of trait interrelationship should be the same in all heterotrait triangles in both monomethod and heteromethod blocks.

In the case of the multi-rater CFA model as applied to the PGLCQ, the Multitrait-Multirater (MTMR) matrix needed to be expanded so that each of the nine latent graduate leader competencies are represented by 10 items (rather than a single composite measure). Given two different categories of raters that evaluated graduate leaders (self and other), a 180 x 180 MTMR matrix is therefore implied. The critical question therefore is whether it is permissible to derive

construct-referenced inferences from the response of self- and other-raters to the PGLCQ items. Does the multi-rater use of the PGLCQ display construct validity? In terms of the preceding line of reasoning, this requires that the observed inter-item MTMR matrix complies with the aforementioned Campbell and Fiske (1959) criteria.

The observed inter-item MTMR correlation matrix with the reliability entries in the main diagonal replaced by item variances serves as basis for the evaluation of the multi-group CFA measurement model. When fitting the multi-rater CFA model (equation 3.2) estimates for the freed measurement model parameters are iteratively derived in an attempt to as closely as possible reproduce the inter-item MTMR correlation matrix. If estimates for the freed measurement model parameters can be obtained that mathematically allows a close reproduction of the observed MTMR matrix, the model and its parameter estimates become a permissible account of the process that created the MTMR matrix.

Marsh and Grayson (cited in Hole, 1995, p.181) agree with Kashy and Kenny (1992) that the CFA-CCCR model offers the possibility of an alternative evaluation of the construct validity of a measure in terms of (at least some) of the Campbell and Fiske (1959) criteria:

An advantage of this general CFA-CTCM model is the apparently unambiguous interpretation of convergent validity, discriminant validity, and method effects: large trait factor loadings indicate support for convergent validity, large method factor loadings indicate the existence of method effects, and large trait correlations-particularly those approaching 1 indicate a lack of discriminant validity.

When the CFA-CCCR measurement model shows good fit, the parameter estimates may be regarded as plausible in the sense that the fitted model can accurately reproduce the observed inter-item MTMR correlation matrix. When interpreting the completely standardised solution of the CFA-CCCR model in which both latent variables and item indicators have been standardised to have a mean of zero and unit standard deviation of one, the off-diagonal hetero-trait-hetero-method inter-item correlations in the MTMR matrix can be estimated via equation 3.4 (Goffin & Jackson, 1992; Lance et al., 2000):

$$r(X_i S_i; X_j, O_j) = \lambda(\xi_{Ci}) \lambda(\xi_{Cj}) \phi(\xi_{Ci}; \xi_{Cj}) + \lambda(\xi_{Ri}) \lambda(\xi_{Rj}) \phi(\xi_{Ri}; \xi_{Rj}) \text{-----} [3.4]$$

where:

- $r(X_i S_i; X_j, O_j)$  represents the correlation between the responses of self-rater  $i$  to item  $X_i$  as a measure of competency  $\xi_i$  and other-rater  $j$  to item  $X_j$  as a measure of competency  $\xi_j$ ;
- $\lambda(\xi_{Ci})$  and  $\lambda(\xi_{Cj})$  refer to the completely standardised factor loading of item  $X_i$  on competency  $\xi_i$  and the completely standardised factor loading of item  $X_j$  on competency  $\xi_j$ ;
- $\phi(\xi_{Ci}; \xi_{Cj})$  refers to the completely standardised covariance (i.e. correlation) between competency  $\xi_i$  and competency  $\xi_j$ ;
- $\lambda(\xi_{Ri}) \lambda(\xi_{Rj})$  refer to the completely standardised factor loading of item  $X_i$  on rater  $\xi_i$  and the completely standardised factor loading of item  $X_j$  on rater  $\xi_j$ ;
- $\phi(\xi_{Ri}; \xi_{Rj})$  refers to the completely standardised covariance (i.e. correlation) between rater  $\xi_i$  and rater  $\xi_j$ ;

The off-diagonal monotrait-heteromethod inter-item correlations in the MTMR matrix in turn can be estimated via equation 3.5 (Lance et al., 2000):

$$r(X_i S_i; X_j, O_j) = \lambda(\xi_{Ci}) \lambda(\xi_{Cj}) \phi(\xi_{Ci}; \xi_{Cj}) + \lambda(\xi_{Ri}) \lambda(\xi_{Rj}) \phi(\xi_{Ri}; \xi_{Rj})$$

$$= \lambda(\xi_{Ci})\lambda(\xi_{Ci}) + \lambda(\xi_{Ri})\lambda(\xi_{Rj})\phi(\xi_{Ri};\xi_{Rj})^{225} \text{-----} [3.5]$$

The off-diagonal heterotrait–monomethod inter-item correlations in the MTMR matrix in turn can be estimated via equation 3.6 (Lance et al., 2000):

$$r(X_i S_i; X_j S_j) = \lambda(\xi_{Ci})\lambda(\xi_{Cj})\phi(\xi_{Ci};\xi_{Cj}) + \lambda(\xi_{Ri})\lambda(\xi_{Rj})\phi(\xi_{Ri};\xi_{Rj})$$

$$= \lambda(\xi_{Ci})\lambda(\xi_{Cj})\phi(\xi_{Ci};\xi_{Cj}) + \lambda(\xi_{Ri})\lambda(\xi_{Rj}) \text{-----} [3.6]$$

Equations 3.4 – 3.6 demonstrate that the trait and rater variance combine additively (Goffin & Jackson, 1992). Given the assumption made by the CFA-CCCR model that latent competencies and latent rater effects are uncorrelated, this allows the partitioning of the various squared off-diagonal correlation estimates in the heterotrait-heterorater, heterotrait-monorater and homotrait-heterorater blocks to be partitioned into shared variance due to shared latent competency variance and due to shared latent rater effects. Widaman (1985) identified a number of CFA models nested within the CFA-CCCR model that allows the testing of specific hypotheses within the MTMR framework (Bagozzi, Yi, & Phillips, 1991; Lance et al., 2000). Table 3.1 depicts the taxonomy of CFA models proposed by Widaman applicable to the analysis of MTMM/MTMR data.

Table 3.2

*CFA taxonomy of MTMM data*

Trait Structure		Method Structure		
1	Null model	1 General method	<i>m</i> methods only (orthogonal)	<i>m</i> methods only (oblique)
2	1 General trait	2 General factors	1 General + <i>m</i> methods (orthogonal)	1 General + <i>m</i> methods (oblique)
2'	<i>t</i> traits only (orthogonal)	1 General + <i>t</i> traits (orthogonal)	<i>t</i> traits (orthogonal) + <i>m</i> methods (orthogonal)	<i>t</i> traits (orthogonal) + <i>m</i> methods (oblique)
3	<i>t</i> traits only (oblique)	1 General + <i>t</i> traits (oblique)	<i>t</i> traits (oblique) + <i>m</i> methods (orthogonal)	<i>t</i> traits (oblique) + <i>m</i> methods (oblique)

Reprinted from Confirmatory Factor Analysis of Multitrait-Multimethod Data: Many Problems and Few Solutions, by Marsh, H.W., 1989, *Applied Psychological Measurement*, 13(4), p. 338. Copyright 1989 by Applied Psychological Measurement Inc.

Model 3C is the CFA-CCCR model defined in equation 3.2. The hierarchical structure in the Widaman (1985) taxonomy allows the evaluation of the statistical significance of the difference in fit between the general CFA-CCCR model and more restricted models that are nested<sup>226</sup> within the general model (Bagozzi et al., 1991; Lance et al. 2000). This in turn permits formal tests of

<sup>225</sup>This follows since in the standardised solution  $\phi(\xi_{Ci};\xi_{Ci}) = 1$ .

<sup>226</sup> Any given model in the taxonomy is nested within another model if the second model carries a number label that is equal to or larger than the number of the first model, and if the second model carries a letter label that is equal to or larger than (i.e. closer to z) the letter of the first (Widaman, 1985). Therefore, for example model 2A is nested within model 3C.

specific (omnibus) hypotheses on the MTMR matrix. More specifically, Lance et al. (2000) argue that a comparison of the CFA-CCCR model defined in equation 3.2 (Widaman's model 3C) to:

- a model in which the inter-trait/competency correlations are constrained to zero (Widaman's Model 2'C) provides an appropriate omnibus test of discriminant validity;<sup>227</sup>
- a model in which the factor loadings of observed variables on the latent competencies are fixed to zero (Widaman's Model 1C) provides an appropriate omnibus test of convergent validity;<sup>228</sup>
- a model in which the inter-latent rater effect correlations are constrained to zero (Widaman's Model 3B) provides an appropriate omnibus test of the discriminability of the latent rating effects;<sup>229</sup> and
- a model in which the factor loadings of observed variables on the latent rater effects are fixed to zero (Widaman's Model 3A) provides an appropriate omnibus test of the presence of a method/rater effects.<sup>230</sup>

Marsh and Grayson (1995) point out that equation 3.2 assumes that the rater factors only exert a rater main-effect on the item responses. Equation 3.2 describes a model in which the covariance between item responses of self-raters and other raters to the 90 PGLCQ items is explained by the additive effect of the covariance between the latent competencies (taking into account the loading of the items on the latent competencies) and the covariance between the rater latent effects (taking into account the loadings of the items on the latent rater variables) (Goffin & Jackson, 1992). Goffin and Jackson (1992, p. 364), however, caution:

Preliminary evidence provided by Campbell and O'Connell (1967, 1982), Browne (1984), Cudeck (1988), Cudeck and Browne (1983), Goffin (1987), Bagozzi and Yi (1990), and Lastovicka, Murray, & Joachimsthaler (1990), however, suggest that although many matrices may conform to the additive model, it may not be appropriate in all cases. Specifically, these researchers found that, in some matrices, trait and rater (or method) factors may combine in a multiplicative fashion.

Browne (1984), in response to this shortcoming, proposed the Composite Direct Product (CDP) model that formally acknowledges interaction between trait and method (or rater) effects. Wothke and Browne (1990) subsequently cast the procedure suggested by Browne (1984) in a second-order factor analytic mould, which allowed the estimation of the model parameters via generally available software like LISREL (rather than the specialised and not generally accessible software MUTMUM originally developed by Browne (1984)). Figure 3.9 provides an illustration of the CDP model assuming four traits being measured ( $T_i$ ) via three types of ratings ( $F_i$ ) (Dumenci, cited in Brown & Tinsley, 2000, p. 602).

---

<sup>227</sup> If the constrained model does not fit statistically significantly ( $p > .05$ ) and is thus poorer than the general CFA-CCCR model it constitutes strong support for adequate discriminant validity. To conclude that a statistically different difference in fit between models 3C and 2'C, however, seems questionable.

<sup>228</sup> A statistically insignificant ( $p > .05$ ) difference in fit between models 3C and 1C would seriously challenge claims of convergent validity. Conversely, a statistically significant ( $p < .05$ ) difference in fit between models 3C and 1C would constitute support for adequate convergent validity.

<sup>229</sup> A statistically insignificant ( $p > .05$ ) difference in model fit would suggest qualitative distinct rater effects.

<sup>230</sup> A statistically insignificant ( $p > .05$ ) difference in model fit would suggest the absence of rater effects.

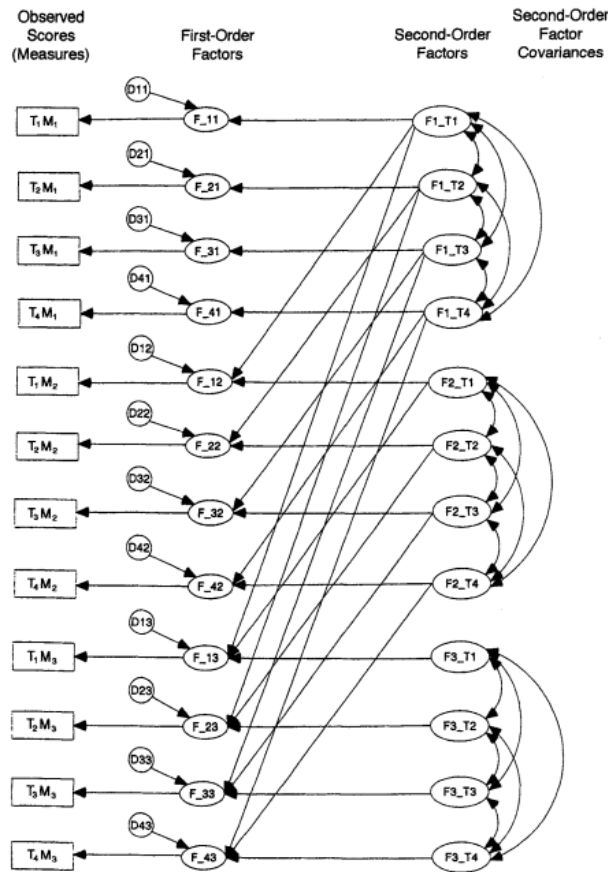

Figure 3.9. Illustration of the Composite Direct Product model. Copied from *The Handbook of Applied Multivariate Statistics and Mathematical Modelling*, by Tinsley, H., & Brown, S., 2000, p. 603. San Diego: Academic Press. Copyright 2000 by Academic Press.

The current study's impression is that discussions of the CDP model (Dumenci, cited in Brown & Tinsley, 2000; Marsh & Grayson, cited in Hole, 1995; Wothke & Browne, 1990) are presented in a manner that obfuscates the essence of the logic underlying the model (at least for all but the highly mathematically sophisticated). The current study consequently prudently decided to restrict the evaluation of the construct validity to the CFA-CCCR model. That this decision introduces a methodological limitation in the study is acknowledged.

Fitting the CFA-CCCR model rather than the conventional CFA measurement model necessitated adapting the *ex post facto* correlational design originally proposed and shown in Figure 3.3 to evaluate the fit of the measurement model. The revised research design is shown in Figure 3.9.  $Y_{ij}S_{ij}$  represents the response of self-rater  $i$  to item  $j$  and  $Y_{ij}O_{ij}$  represents the response of other-rater of graduate leader  $j$  to item  $j$ . Rows represent graduate leaders and columns represent the response of self- and other raters to the 90 items of the PGLCQ.

$[Y_{11}S_{11}]$	$[Y_{11}O_{11}]$	$[Y_{12}S_{12}]$	$[Y_{12}O_{12}]$	...	$[Y_{1j}S_{1j}]$	$[Y_{1j}O_{1j}]$	...	$[Y_{1,90}S_{1,90}]$	$[Y_{1,90}O_{1,90}]$
$[Y_{21}S_{21}]$	$[Y_{21}O_{21}]$	$[Y_{22}S_{22}]$	$[Y_{22}O_{22}]$	...	$[Y_{2j}S_{2j}]$	$[Y_{2j}O_{2j}]$	...	$[Y_{2,90}S_{2,90}]$	$[Y_{2,90}O_{2,90}]$
:	:	:	:	:	:	:	:	:	:
$[Y_{i1}S_{i1}]$	$[Y_{i1}O_{i1}]$	$[Y_{i2}S_{i2}]$	$[Y_{i2}O_{i2}]$	...	$[Y_{ij}S_{ij}]$	$[Y_{ij}O_{ij}]$	...	$[Y_{i,90}S_{i,90}]$	$[Y_{i,90}O_{i,90}]$
:	:	:	:	:	:	:	:	:	:
$[Y_{n1}S_{n1}]$	$[Y_{n1}O_{n1}]$	$[Y_{n2}S_{n2}]$	$[Y_{n2}O_{n2}]$	...	$[Y_{nj}S_{nj}]$	$[Y_{nj}O_{nj}]$	...	$[Y_{n,90}S_{n,90}]$	$[Y_{n,90}O_{n,90}]$

**Figure 3.9.** Revised ex post facto correlational design used to evaluate the PGLCQ measurement model

Note:  $S_{ij}$  represents the self-rating of graduate leader  $i$  on item  $j$  and  $O_{ij}$  represents the other-rating of graduate leader  $i$  on item  $j$ .

Although the preceding discussion referred at times to the analysis of an observed multi-rater inter-item correlation matrix the current study followed the recommendation of Lance et al. (2000) to still analyse the multi-rater inter-item covariance matrix rather than the polychoric correlation matrix (Jöreskog & Sörbom, 1996b).

Fitting the CFA-CCCR model rather than the conventional CFA measurement model had dramatically increased the number of freed measurement model parameters from 216 to 577.<sup>231</sup> The current study's sample size requirement as judged by the lower bound of the Bentler and Chou (1987) guideline were therefore dramatically increased from 1080 to 2885. However, the decision to impose tau-equivalent constraints on the measurement (and comprehensive LISREL) models given the researcher's access to a relatively small sample size reduced the number of lambdas in need of estimation from 180 to 18, implying that the freed parameters in need of estimation (given the use of the CCCR model)<sup>232</sup> were reduced from 577 to 415.<sup>233</sup>

On the proviso that the fitting of the measurement model yielded satisfactory (fit) results, the fitting of the comprehensive LISREL model essentially proceeded in the same manner as discussed above. With the fitting of the comprehensive LISREL model, however, the *path model* was added to the *measurement model* in the LISREL syntax, allowing for the combined testing of the composite succession of structural equations – similar to running several regression analyses on the latent score estimates obtained for the nine latent (second-order) graduate leader competencies. The resultant regression (or path coefficients) reflect the nature of the correlational relationships that exist between the latent variables included in each structural equation **in addition** to the nature of the relationships between indicator variables and the latent variables they were designed to reflect. The aim is still to minimise the difference between the estimated and observed covariance matrices. The same goodness of fit indices were used for evaluating the appropriateness of the model post-fit.

<sup>231</sup> The change from items to item-rater type dyads as observed variables in the in research design caused a dramatic increase in factor loadings and error variances. The CFA-CCCR model has 180 freed loadings of observed variables on latent competencies, 180 factor loadings of observed variables on latent rater effects, 180 measurement error variances, 36 inter latent competency correlations and a single inter-latent rater effect correlation.

<sup>232</sup> In other words, in both the measurement and comprehensive LISREL models the lambda and theta-delta terms are allowed to vary across indicators but tau is set at zero and as equal across items.

<sup>233</sup>  $577 - 162 = 415$ .



### 3.9.3.1 Goodness of fit indices

Rather than basing the final decision of model fit exclusively on one or two favourable fit indices,<sup>234</sup> the full spectrum of fit indices available in LISREL 8.8 was considered before coming to an integrated verdict on model fit.<sup>235</sup> The process involved in coming to a final decision on model fit, however, was complex as the structural mechanics of SEM are complicated (Hermida, Luchman, Nicolaidis & Wilcox, 2015) and compounded by the fact that the different goodness of fit indices provide different pieces of information about model fit (Brown, 2006) and accordingly, might actually contradict each other under certain circumstances. This is because the numerous indices that LISREL produces each serve to optimise slightly different objective functions – i.e. they provide complementary information that varies in terms of whether they are related to sample size or not, whether they assess absolute fit or fit relative to a benchmark model, or whether they favour parsimony or not (Iacobucci, 2010).

Fit indices are moreover not robust across estimation methods (e.g. Maximum Likelihood versus Generalised Least Squares), the distributional properties of the sample data (e.g. violations of multivariate normality) (Hu & Bentler, cited in Hoyle, 1995) and sample size, implying that the choice of the appropriate indices to use and the permissibility of the inferences made from these had to be contemplated and justified by inspecting the data, its distribution and/or considering other estimator options if and where necessary for the current study first. A more in-depth discussion on this and the reasons underlying the methodological choices made in reporting the current study's results will subsequently follow in Chapter 5. Nevertheless, based on suggestions from Barrett (2007), Diamantopoulos & Sigua (2000), Hu and Bentler (cited in Hoyle, 1995), Hunter (2014), Kelloway (1998), Tabachnick and Fidell (2007) and Wheaton, Muthen, Alwin, and Summers (1977), Table 3.3 below describes popular fit indices that are often used in the evaluation of fitted models, which served as the primary guidelines for assisting the researcher in carrying out this task. Moreover, as the RMSEA (explicitly) and the normal theory (or Satorra-Bentler) chi-square (implicitly) statistics are implicated for use by the study's overarching substantive research hypotheses and the latter (despite its well-documented flaws)<sup>236</sup> should be routinely reported (Hayduk, Cummings, Boadu, Pazderka-Robinson, & Boulianne, 2007; Kline, 2005) along with its degrees of freedom and  $p$  value (Kline, 2011), the researcher aimed in any case to include these goodness of fit indices as the core statistics in the *report basket* as presented in Chapter 5.

### 3.9.3.2 Informal/supplementary indications of fit

Although the examination of the goodness of fit indices is typically regarded as the core element of a post-analysis fit-evaluation exercise (Schreiber et al., 2006), the researcher also utilised informal methods (Gerbing and Anderson, cited in Bollen & Long, 1993) in evaluating/verifying the results obtained from and in addition to these customised statistics for both models as well. Firstly, the residual covariances were scrutinised for patterns in the residual matrix “as a sign of ill fit” (Schermelleh-Engel et al., 2003 p. 24). Standardised residuals indicate the discrepancies between elements of the input and fitted covariance matrices in a manner roughly similar to a Z-statistic, and systematic differences between the sample data and the model-implied covariance matrix, even if small, therefore warrants caution (Hayduk, 1996).

---

<sup>234</sup> Such a collection of indices often entices researchers to select only those that stand in support of good fit. This, however, is a practice that is often criticised as it usually indicates an attempt to, or results in the masking of any potential model misspecifications.

<sup>235</sup> Note that goodness of fit indices are applicable for use in evaluating both the measurement and comprehensive LISREL models.

<sup>236</sup> “The chi-squared test can be comparatively grossly underpowered for tiny data sets and fail to reach statistical significance. It can also be comparatively super-powered for huge data sets, reaching statistical significance in the presence of negligible differences” (Rose, Markman, & Sawilowsky, 2017, p. 71).

Table 3.3

*Descriptions and thresholds of goodness of fit indices contemplated for use in the assessment of both measurement and structural models*

FIT INDEX	DESCRIPTION	CUT-OFFS
$\chi^2$	Uses the non-centrality parameter to test the null hypothesis that the estimated covariance–variance matrix deviates from the sample variance–covariance matrix.	$\chi^2$ is 0 when model fit is perfect; $p > .05$ .
$\chi^2/df$	Adjusted Chi-square statistic to minimise the impact of sample size.	Ratios of between 5.0 and 2.0.
RMSEA	Based on the non-centrality parameter and calculates the error of approximation between estimated model and sample observations per degrees of freedom.	< 0.01: outstanding fit; < 0.05: good fit; < 0.08: reasonable fit.
Confidence Interval (RMSEA)	A confidence interval of RMSEA testing the hypothesis of close fit – i.e. $H_0: RMSEA < 0.05$	90%.
RMR	The mean absolute value of the raw residuals between the estimated and sample variance-covariance matrices.	< 0.05: good fit; < 0.08: borderline acceptable.
Satorra Bentler	Adjustment to Chi-square to accommodate non-normal data.	$\chi^2$ is 0 when model fit is perfect; $p > .05$ .
SRMR	Same as RMR but expressed in standardised units (i.e. correlation coefficients).	< 0.05: good fit; < 0.08: borderline acceptable.
GFI	An alternative to $\chi^2$ that calculates the proportion of variance that is accounted for in the sample by the estimated population covariance matrix. Not adjusted	$\geq 0.90$ .
AGFI	Same as GFI but adjusted for degrees of freedom.	$\geq 0.90$ .
CFI	Assumes that all latent variables are uncorrelated (i.e. null/independence model) showing how much better the estimated model fits compared to this independent	$\geq 0.95$ .

More specifically, the researcher hoped that model fit would not yield a significant proportion of large (e.g.  $> \pm 2.58$ ) standardised covariance residuals (Seland, 2017), which would have commented negatively on fit for either one of measurement or comprehensive LISREL models.

Secondly, the modification indices calculated for the  $\Lambda$  and  $\Theta_{\delta}$  matrices of the measurement model were investigated and also used as further input for the evaluation of model fit. Conversely, for the comprehensive LISREL model, the modification indices calculated for the  $\Gamma$ ,  $B$ , and  $\Psi$  matrices were inspected for the same purpose if the analysis proceeded to this stage. These are calculated for the fixed parameters of the model where there are no paths, and indicate the extent to which the model fit would improve when allowing for (i.e. setting free) such paths. Even though some SEM practitioners use modification indices as guidelines for changing/correcting and refitting models, the researcher refrained from this practice and only used them in a more broad sense as red flags of non-fit. In cases where a small percentage of large (e.g. 6.6449) modification index values in the matrices was observed, this was interpreted as positive confirmation of model fit (Seland, 2017).

### 3.9.3.3 Interpretation of measurement and structural model parameter estimates

Conditional on a finding of close fit (or at least reasonable measurement model fit, the measurement model parameters were also analysed by testing the relevant statistical null hypotheses that were formulated under section 3.5 as statistical translations of the operational hypotheses formulated under section 3.2. Operational hypotheses 1 – 5 were formulated on the assumption that the construct validity of the PGLCQ will be tested by (inter alia) fitting a conventional confirmatory factor analysis measurement model with nine latent competencies

and 90 item indicators. The argument presented under section 3.8.3, however, suggested that the fitting of a CFA-CCCR model was more appropriate given the fact that multi-rater data was collected on the PGLCQ.

This required that the operational hypotheses that were originally formulated for the measurement model had to be rewritten and that the statistical hypotheses associated with the measurement model likewise had to be adapted. The operational hypotheses and statistical hypotheses for the structural model remained unaffected but for a change in numbering.

The overarching substantive hypothesis (i.e. Hypothesis 1) of this study remains that the PGLCQ provides a reliable and construct valid measure of the generic graduate leader (behavioural) competency domain as illuminated in Chapter 2. The overarching substantive hypothesis was still dissected into two narrower, albeit subtly rephrased, substantive research hypotheses:

- Hypothesis 1a: The CFA-CCCR measurement model reflecting the constitutive definition of the graduate leader performance construct (interpreted behaviourally), the design intent of the PGLCQ and the multi-rater format of the PGLCQ provides a valid account of the psychological mechanism that regulates test-takers responses to the items of the PGLCQ; and
- Hypothesis 1b: The structural model implied by the connotative meaning of the graduate leader performance construct (interpreted behaviourally) as expressed by the internal structure assigned to the construct taken in conjunction with the design intent of the PGLCQ, provides a valid account of the psychological processes underpinning the level of performance that graduates attain on the behavioural components of the graduate leader job performance construct (i.e. on the second-order graduate leadership competencies).

The overarching substantive hypothesis subsumed a number of more in-depth operational hypotheses. More specifically operational hypotheses 1 – 6 were dissected from the revised first narrow substantive hypothesis and operational hypotheses 7 – 9 were derived from the second narrow substantive hypothesis:

- Operational hypothesis 1: The CFA-CCCR measurement model implied by the scoring key, the design intent of the PGLCQ and the multi-rater format of the PGLCQ closely reproduces the covariances observed between the observed variables<sup>237</sup> (item-rater dyads) included in the MTMR matrix;
- Operational hypothesis 2a: The factor loadings of the observed variables on their designated (second-order) graduate leader competencies ( $\xi_1$ - $\xi_9$ ) are statistically significant ( $p < .05$ );
- Operational hypothesis 2b: The factor loadings of the observed variables on the latent rater variables ( $\xi_1$  (self-rating) and  $\xi_2$  (other-rating)) are statistically significant ( $p < .05$ );
- Operational hypothesis 3a: The graduate leader (second-order) competencies ( $\xi_1$  -  $\xi_9$ ) explain large proportions of the variance in the observed variables that represent them respectively;
- Operational hypothesis 3b: The latent rater variables ( $\xi_1$  (self-rating) and  $\xi_2$  (other-rating)) explain small proportions of the variance in the observed variables;
- Operational hypothesis 4: The measurement error variances associated with each observed variable are statistically significant ( $p < .05$ ) yet small ( $\theta_{\delta ii} \geq .75$ );
- Operational hypothesis 5a: The latent graduate leader (second order) competencies correlate statistically significantly ( $p < .05$ ) while not excessively high with each other ( $\phi_{ij} < .90$ ), providing evidence of *discriminant validity*;

---

<sup>237</sup> The observed variables represent the response of the  $i^{\text{th}}$  type of rater to an item reflecting the  $j^{\text{th}}$  latent competency as measured by the  $j^{\text{th}}$  Method).

- Operational hypothesis 5b: The latent rater effects correlate statistically significantly ( $p < .05$ ) while low with each other;
- Operational hypothesis 6: The competency domain structural model implied by the manner in which the constitutive definition of the graduate leader behavioural performance construct embeds (second-order) competencies in a nomological network of latent variables as described in Chapter 2 can closely reproduce the covariances observed between the items comprising each of the PGLCQ scales; and
- Operational hypothesis 7: The slope of the regression of  $\eta_j$  on  $\xi_i$  and the regression of  $\eta_j$  on  $\eta_i$  in the structural model implied by the manner in which the constitutive definition of the graduate leader behavioural performance construct embeds competencies in a nomological network of latent variables are statistically significant ( $p < .05$ ). Operational hypothesis 7 thus implies the testing of 18 path-specific substantive hypotheses below:
  - Path-specific substantive hypothesis 1: In the proposed graduate leadership@work competency domain structural model<sup>238</sup> it is hypothesised that a high level of personal leader proficiency ( $\xi_1$ ) will improve leadership effectiveness in entrenching a high-performance culture in the unit ( $\eta_1$ );
  - Path-specific substantive hypothesis 2: In the proposed graduate leadership@work competency domain structural model it is hypothesised that a high level of personal leader proficiency ( $\xi_1$ ) will improve leadership effectiveness in creating an exciting and aspirational vision ( $\eta_2$ );
  - Path-specific substantive hypothesis 3: In the proposed graduate leadership@work competency domain structural model it is hypothesised that a high level of personal leader proficiency ( $\xi_1$ ) will improve leadership effectiveness in analysing and understanding the external and internal work unit environment ( $\eta_3$ );
  - Path-specific substantive hypothesis 4: In the proposed graduate leadership@work competency domain structural model it is hypothesised that a high level of personal leader proficiency ( $\xi_1$ ) will improve leadership effectiveness in the development of unit competitiveness ( $\eta_4$ );
  - Path-specific substantive hypothesis 5: In the proposed graduate leadership@work competency domain structural model it is hypothesised that a high level of personal leader proficiency ( $\xi_1$ ) will improve leadership effectiveness in the management of the unit's internal environment ( $\eta_8$ );
  - Path-specific substantive hypothesis 6: In the proposed graduate leadership@work competency domain structural model it is hypothesised that high proficiency on the entrenchment of a high-performance culture ( $\eta_1$ ) will improve leadership effectiveness in strengthening and enabling followers ( $\eta_7$ );
  - Path-specific substantive hypothesis 7: In the proposed graduate leadership@work competency domain structural model it is hypothesised that high proficiency on the entrenchment of a high-performance culture ( $\eta_1$ ) will improve leadership effectiveness in uniting and connecting followers ( $\eta_6$ );
  - Path-specific substantive hypothesis 8: In the proposed graduate leadership@work competency domain structural model it is hypothesised that high proficiency on the entrenchment of a high-performance culture ( $\eta_1$ ) will improve leadership effectiveness in involving others and eliciting participation ( $\eta_5$ );
  - Path-specific substantive hypothesis 9: In the proposed graduate leadership@work competency domain structural model it is hypothesised that high proficiency on involving others and eliciting participation ( $\eta_5$ ) will improve leadership effectiveness in the development of unit competitiveness ( $\eta_4$ );

---

<sup>238</sup> The phrase in the proposed graduate leadership@work competency domain structural model is used on purpose to reflect the fact that  $\gamma_{ij}$  and  $\beta_{ij}$  represent partial regression coefficients that reflect the average change in  $\eta_i$  associated with one unit change in  $\xi_j$  or  $\eta_j$  when controlling for the other latent variables in the structural equation of  $\eta_i$ .

- Path-specific substantive hypothesis 10: In the proposed graduate leadership@work competency domain structural model it is hypothesised that high proficiency on analysing and understanding the external and internal work environment ( $\eta_3$ ) will improve leadership effectiveness in developing the unit's competitiveness ( $\eta_4$ );
- Path-specific substantive hypothesis 11: In the proposed graduate leadership@work competency domain structural model it is hypothesised that high proficiency on developing unit competitiveness ( $\eta_4$ ) will improve leadership effectiveness in managing the unit's internal environment ( $\eta_8$ );
- Path-specific substantive hypothesis 12: In the proposed graduate leadership@work competency domain structural model it is hypothesised that high proficiency on strengthening and enabling followers ( $\eta_7$ ) will improve leadership effectiveness in managing the unit's internal environment ( $\eta_8$ );
- Path-specific substantive hypothesis 13: In the proposed graduate leadership@work competency domain structural model it is hypothesised that high proficiency on uniting and connecting followers ( $\eta_6$ ) will improve leadership effectiveness in managing the unit's internal environment ( $\eta_8$ );
- Path-specific substantive hypothesis 14: In the proposed graduate leadership@work competency domain structural model it is hypothesised that high proficiency on involving others and eliciting participation ( $\eta_5$ ) will improve leadership effectiveness in managing the unit's internal environment ( $\eta_8$ );
- Path-specific substantive hypothesis 15: In the proposed graduate leadership@work competency domain structural model it is hypothesised that high proficiency on the management of the unit's internal environment ( $\eta_8$ ) will improve leadership effectiveness in analysing and understanding the external and internal work unit environment ( $\eta_3$ );
- Path-specific substantive hypothesis 16: In the proposed graduate leadership@work competency domain structural model it is hypothesised that high proficiency on analysing and understanding the external and internal work unit environment ( $\eta_3$ ) will improve leadership effectiveness in the creation of an exciting and aspirational vision ( $\eta_2$ );
- Path-specific substantive hypothesis 17: In the proposed graduate leadership@work competency domain structural model it is hypothesised that high proficiency on the creation of an exciting and aspirational vision ( $\eta_2$ ) will improve leadership effectiveness in entrenching a high-performance culture in the unit ( $\eta_1$ ); and
- Path-specific substantive hypothesis 18: In the proposed graduate leadership@work competency domain model it is hypothesised that high proficiency on the creation of an exciting and aspirational vision ( $\eta_2$ ) will improve leadership effectiveness in developing the unit's competitiveness ( $\eta_4$ ).
- Operational hypothesis 8: The structural error variances associated with each endogenous latent variable in the competency domain structural model are statistically significant ( $p < .05$ ) and large ( $\psi_{jj} \geq .70$ ).

The change in the fitted measurement model and the associated change in the operational hypotheses necessarily also affected the statistical hypotheses associated with the CFA-CCCR measurement model. This subsequently had a knock-on effect on the numbering of the statistical hypotheses associated with the comprehensive LISREL model and it turned the exogenous latent variable in the model into an endogenous latent variable.

The exact and close fit hypotheses associated with the measurement model ( $H_{01}$  and  $H_{02}$ ) remained unchanged.  $H_{02}$  remains a statistical translation of operational hypothesis 1. It follows that if either  $H_{01}$  and/or  $H_{02}$  was not rejected and exact and/or close fit had been achieved, or alternatively if the CCCR measurement model at least demonstrated reasonable fit, it was

considered permissible to interpret the estimates obtained for the freed CCCR measurement model parameters by testing operational hypotheses 2 – 6.

Operational hypothesis 2a was tested by testing the following 90 null hypotheses on the slope of the regression of observed variable  $j$  on specific latent graduate leader competencies  $k$  (i.e. by testing the following 180 null hypotheses on the freed elements of  $\Lambda^X$ ):

$$H_{0i}: \lambda_{jk} = 0; i = 3, 4, \dots, 182; j = 1, 2, \dots, 180; k = 1, 2, \dots, 9$$

$$H_{ai}: \lambda_{jk} > 0; i = 3, 4, \dots, 182; j = 1, 2, \dots, 180; k = 1, 2, \dots, 9^{239}$$

Operational hypothesis 2b was tested by testing the following 90 null hypotheses on the slope of the regression of observed variable  $j$  on latent rating variables ( $\xi_1$  (self-rating) and  $\xi_2$  (other-rating)) (i.e. by testing the following 180 null hypotheses on the freed elements of the last column in  $\Lambda^Y$ ):

$$H_{0i}: \lambda_{jk} = 0; i = 183, 184, \dots, 362; j = 1, 2, \dots, 180; k = 10, 11$$

$$H_{ai}: \lambda_{jk} \neq 0; i = 183, 184, \dots, 362; j = 1, 2, \dots, 180; k = 10, 11^{240}$$

Operational hypothesis 4 was tested by testing the following 180 null hypotheses on the freed elements in the variance-covariance matrix  $\Theta_8$ :

$$H_{0i}: \theta_{\delta ij} = 0; i = 363, 364, \dots, 542; j = 1, 2, \dots, 180$$

$$H_{ai}: \theta_{\delta ij} > 0; i = 363, 364, \dots, 542; j = 1, 2, \dots, 180$$

Operational hypothesis 5a was tested by testing the following 36 null hypotheses on the freed elements in the variance-covariance matrix  $\Phi$ :

$$H_{0i}: \phi_{kp} = 0; i = 543, 544, \dots, 578; k = 1, 2, \dots, 9; p = 1, 2, \dots, 9; j \neq k$$

$$H_{ai}: \phi_{kp} > 0; i = 543, 544, \dots, 578; k = 1, 2, \dots, 9; p = 1, 2, \dots, 9; j \neq k$$

Operational hypothesis 5b was tested by testing the following single null hypothesis on the freed elements in the variance-covariance matrix  $\Phi$ :

$$H_{0i}: \phi_{kp} = 0; i = 579; k = 10, 11; p = 10, 11; j \neq k$$

$$H_{ai}: \phi_{kp} > 0; i = 579; k = 1, 2, \dots, 9; p = 10, 11; j \neq k$$

The second narrow substantive hypothesis (i.e. Hypothesis 1b) proposed that if the PGLCQ provides a construct valid and reliable measure of the behavioural component of graduate (leader) job performance as constitutively defined in accordance with the design intent of the instrument then the PGLCQ competency domain comprehensive LISREL model should fit item data obtained on the PGLCQ. If this claim is to be interpreted to suggest that the hypothesised comprehensive LISREL model provides an exact account of the psychological mechanism that produced the observed inter-item parcel covariance matrix in the parameter, this argument translates into the following *exact fit* hypothesis:

$$H_{0580}: RMSEA = 0$$

$$H_{a580}: RMSEA > 0$$

When acknowledging the more likely possibility that the comprehensive LISREL model hypothesised to underlie the PGLCQ will only be able to approximate the processes that in reality

<sup>239</sup> The directional  $H_{ai}$  hypotheses imply that all the items of the PGLCQ were coded so that they load positively on the latent competency they were earmarked to reflect.

<sup>240</sup> The directional  $H_{ai}$  hypotheses imply that all the items of the PGLCQ were coded so that they load positively on the latent competency they were earmarked to reflect.

created the observed inter-item parcel covariance matrix, the following *close fit* null hypothesis ( $H_{0220}$ ) was also tested (Browne & Cudeck, cited in Bollen & Long, 1992):

$H_{0581}$ :  $RMSEA \leq .05$

$H_{a581}$ :  $RMSEA > .05$

$H_{5810}$  represents a statistical translation of operational hypothesis 6. It follows that if either  $H_{0580}$  and/or  $H_{0581}$  was not rejected and exact and/or close fit had been achieved, or alternatively if the comprehensive model at least demonstrated reasonable fit (given that  $H_{01}$  and/or  $H_{02}$  had not been rejected), it was considered permissible to interpret the estimates obtained for the freed structural model parameters by testing operational hypotheses 7. Operational hypothesis 7 implies the testing of the following 18 path-specific substantive hypotheses by testing the following 18 null hypotheses:

Path-specific substantive hypothesis 1: In the proposed graduate leadership@work competency domain model it was hypothesised that a high level of *personal leader proficiency* will improve leadership effectiveness in *entrenching a high-performance culture* in the unit.

$H_{0582}$ :  $\gamma_{11} = 0$

$H_{a582}$ :  $\gamma_{11} > 0$

Path-specific substantive hypothesis 2: In the proposed graduate leadership@work competency domain model it was hypothesised that a high level of *personal leader proficiency* will improve leadership effectiveness in creating an *exciting and aspirational vision*.

$H_{0583}$ :  $\gamma_{21} = 0$

$H_{a583}$ :  $\gamma_{21} > 0$

Path-specific substantive hypothesis 3: In the proposed graduate leadership@work competency domain model it was hypothesised that a high level of *personal leader proficiency* will improve leadership effectiveness in *analysing and understanding the external and internal work unit environment*.

$H_{0584}$ :  $\gamma_{31} = 0$

$H_{a584}$ :  $\gamma_{31} > 0$

Path-specific substantive hypothesis 4: In the proposed graduate leadership@work competency domain model it was hypothesised that a high level of *personal leader proficiency* will improve leadership effectiveness in the *development of unit competitiveness*.

$H_{0585}$ :  $\gamma_{41} = 0$

$H_{a585}$ :  $\gamma_{41} > 0$

Path-specific substantive hypothesis 5: In the proposed graduate leadership@work competency domain model it was hypothesised that a high level of *personal leader proficiency* will improve leadership effectiveness in the *management of the unit's internal environment*.

$H_{0586}$ :  $\gamma_{81} = 0$

$H_{a586}$ :  $\gamma_{81} > 0$

Path-specific substantive hypothesis 6: In the proposed graduate leadership@work competency domain model it was hypothesised that high proficiency on the *entrenchment of a high-performance culture* will improve leadership effectiveness in *strengthening and enabling followers*.

$$H_{0587}: \beta_{71} = 0$$

$$H_{a587}: \beta_{71} > 0$$

Path-specific substantive hypothesis 7: In the proposed graduate leadership@work competency domain model it was hypothesised that high proficiency on the *entrenchment of a high-performance culture* will improve leadership effectiveness in *uniting and connecting followers*.

$$H_{0588}: \beta_{61} = 0$$

$$H_{a588}: \beta_{61} > 0$$

Path-specific substantive hypothesis 8: In the proposed graduate leadership@work competency domain model it was hypothesised that high proficiency on the *entrenchment of a high-performance culture* will improve leadership effectiveness in *involving others and eliciting participation*.

$$H_{0589}: \beta_{51} = 0$$

$$H_{a589}: \beta_{51} > 0$$

Path-specific substantive hypothesis 9: In the proposed graduate leadership@work competency domain model it was hypothesised that high proficiency on *involving others and eliciting participation* will improve leadership effectiveness in the *development of unit competitiveness*.

$$H_{0590}: \beta_{45} = 0$$

$$H_{a590}: \beta_{45} > 0$$

Path-specific substantive hypothesis 10: In the proposed graduate leadership@work competency domain model it was hypothesised that high proficiency on *analysing and understanding the external and internal work unit environment* ( $\eta_3$ ) will improve leadership effectiveness in *developing the unit's competitiveness*.

$$H_{0591}: \beta_{43} = 0$$

$$H_{a591}: \beta_{43} > 0$$

Path-specific substantive hypothesis 11: In the proposed graduate leadership@work competency domain model it was hypothesised that high proficiency on *developing unit competitiveness* will improve leadership effectiveness in *managing the unit's internal environment*.

$$H_{0592}: \beta_{84} = 0$$

$$H_{a592}: \beta_{84} > 0$$

Path-specific substantive hypothesis 12: In the proposed graduate leadership@work competency domain model was hypothesised that high proficiency on *strengthening and enabling followers* will improve leadership effectiveness in *managing the unit's internal environment*.

$$H_{0593}: \beta_{87} = 0$$

$$H_{a593}: \beta_{87} > 0$$



Path-specific substantive hypothesis 13: In the proposed graduate leadership@work competency domain model it was hypothesised that high proficiency on *uniting and connecting followers* will improve leadership effectiveness in *managing the unit's internal environment*.

$$H_{0594}: \beta_{86} = 0$$

$$H_{a594}: \beta_{86} > 0$$

Path-specific substantive hypothesis 14: In the proposed graduate leadership@work competency domain model it was hypothesised that high proficiency on *involving others and eliciting participation* ( $\eta_5$ ) will improve leadership effectiveness in *managing the unit's internal environment* ( $\eta_8$ );

$$H_{0595}: \beta_{85} = 0$$

$$H_{a3595} \beta_{85} > 0$$

Path-specific substantive hypothesis 15: In the proposed graduate leadership@work competency domain model it is hypothesised that high proficiency on the *management of the unit's internal environment* will improve leadership effectiveness in *analysing and understanding the external and internal work unit environment*.

$$H_{0596}: \beta_{38} = 0$$

$$H_{a596}: \beta_{38} > 0$$

Path-specific substantive hypothesis 16: in the proposed graduate leadership@work competency domain model it was hypothesised that high proficiency on *analysing and understanding the external and internal work unit environment* ( $\eta_3$ ) will improve leadership effectiveness in the *creation of an exciting and aspirational vision*.

$$H_{0597}: \beta_{23} = 0$$

$$H_{a597}: \beta_{23} > 0$$

Path-specific substantive hypothesis 17: In the proposed graduate leadership@work competency domain model it was hypothesised that high proficiency on the *creation of an exciting and aspirational vision* will improve leadership effectiveness in *entrenching a high-performance culture* in the unit.

$$H_{0598}: \beta_{12} = 0$$

$$H_{a598}: \beta_{12} > 0$$

Path-specific substantive hypothesis 18: In the proposed graduate leadership@work competency domain model it was hypothesised that high proficiency on the *creation of an exciting and aspirational vision* will improve leadership effectiveness in *developing the unit's competitiveness*.

$$H_{0599}: \beta_{42} = 0$$

$$H_{a599}: \beta_{42} > 0$$

Operational hypothesis 8 was tested by testing the following 8 null hypotheses on the freed elements in the variance-covariance matrix  $\Psi$ :

$$H_{0i}: \psi_{kk} = 0; i = 600, 601, \dots, 607; k = 1, 2, \dots, 8$$

$$H_{ai}: \psi_{kk} > 0; i = 600, 601, \dots, 607; k = 1, 2, \dots, 8$$

Hypotheses  $H_{01} - H_{0322}$  were tested on a 5% significance level. In the case of directional alternative hypotheses the critical z score was set to  $\pm 1.6449$  to test the relevant statistical hypothesis listed

under paragraph 3.5. In the case of directional alternative hypotheses the critical z score was set to  $\pm 1.96$ .  $H_{0i}$  was only rejected if the exceedance probability was sufficiently low and if the sign of the estimate was in accordance with the position taken under  $H_{ai}$ . The magnitude of all statistically significant CFA-CCCR measurement model and comprehensive model parameter estimates ( $p < .05$ ) were interpreted in the completely standardised solution of the measurement and comprehensive model output.

### 3.9.3.4 Discriminant validity

Finally, the evaluation of the construct validity of the PGLCQ would not be complete without a more in-depth investigation into the discriminant validity of the PGLCQ. This is essential, as in addition to the degree of confidence one has that the (graduate) leader competencies are reliably and validly measured by the PGLCQ, the degree to which the PGLCQ measures of the different graduate leader competencies are sufficiently unrelated is of great significance in the ultimate substantiation of construct validity (Campbell & Fiske, 1959) as well. If discriminant validity cannot be explicitly proven, the validity of any construct in the theory and its related individual indicators become questionable (Fornell & Larcker, 1981), bringing a degree of uncertainty as to whether results that confirm hypothesised structural paths are real or whether they actually resulted as statistical artefacts due to the inability of the PGLCQ to distinguish between the latent second-order graduate leader competencies as related but qualitatively distinct latent variables (Farrell, 2010).

The procedure for investigating discriminant validity is well documented in the case of conventional CFA measurement models (Diamantopoulos & Siguaw, 2000; Farrell, 2010; Fornell & Larcker, 1981; Mels, 2010). Due to the multi-rater format of the PGLCQ, it was argued that the conventional CFA measurement model does not provide the most appropriate description of the psychological mechanism that produced the inter-item variance-covariance matrix. It was argued a CFA-CCCR measurement model provides a more accurate description of the mechanism involved. However, in the CFA-CCCR model the latent graduate leader competencies are still modelled as endogenous latent variables along with two latent rater effects. The covariances between the nine endogenous latent variables are still calculated and evaluated in terms of their statistical significance.

The phi matrix was firstly consulted for any excessively large ( $\geq .09$ ) (Hooper, Coughlan, & Mullen, 2008) and significant  $\phi_{ij}$  values (Anderson & Gerbing, 1988) interpreted as a possible failure of the model to successfully discriminate between two related, but quantitatively distinct latent second-order graduate leader competencies. A second concern was despite significant  $\phi_{ij}$  values being less than .90 it was still possible that the performance dimensions might correlate less than unity in the statistic due to sampling error, yet correlate unity in the parameter (Myburgh, 2013). This possibility was investigated by calculating the 95% confidence interval for each of the 36  $\phi_{ij}$  estimates. If any confidence interval includes unity, it was interpreted as a seriously negative comment on the discriminant validity of the PGLCQ. Thirdly, the calculation of the average variance extracted (AVE) for each latent second-order graduate leader competency represented a further option for evaluating the discriminant validity of the PGLCQ. The AVE indicates the average proportion of variance in the indicator variables that is explained by the latent variable that the indicator variables were tasked to represent (Diamantopoulos & Siguaw, 2000). Thus, the AVE of factor-indicator sets that appropriately sorted themselves in the way as conceptually expected/theorised should be high, indicating that each latent graduate leader competency explains more variance in the item earmarked to reflect its subscale than is explained by measurement error. Moreover, each latent graduate leader competency is expected to explain more variance in its designated items than it explains in the other eight related but qualitatively distinct competencies. Accordingly, and in line with advice from Farrell (2010), the claim that the PGLCQ demonstrates discriminant validity would be supported should the average variance

extracted be greater than .50 and greater than the squared correlations between the latent variables ( $\phi^2_{ij}$ ).

### 3.10 CONCLUSION

The chapter reflects a progression from the research objectives as stipulated in Chapter 1 to a substantive hypothesis, and a number of operational hypotheses underlying the investigation into the psychometric properties of the PGLCQ, which in turn, makes the evaluation of the validity of the construct-referenced inferences derived from the PGLCQ as an instrument developed to measure the graduate leader performance construct (behaviourally interpreted) statistically possible. The chapter included an explanation of the overarching *mixed method* research framework that was employed, its research design and sampling strategy. The chapter furthermore describes the methodological choices that were made with regards to the vetting of the (second-order) competencies as extracted from the literature, the item development for the PGLCQ, the choice of the statistical tools that were used to analyse the PGLCQ, and the manner in which the statistical theory underlying these were interpreted and applied. In its entirety, the research design and methodologies employed were positioned as an 'elegant snare' (Ehrenreich, 1991) that was designed for the exclusive purpose of 'capturing' or uncovering the 'cunning logic of nature' – e.g. the identities of, measures for and ways in which the graduate leader competencies structurally combine to form part of the psychological mechanism that regulates the level of performance that graduates attain on the behavioural component of the graduate leader job performance construct (behaviourally interpreted). The chapter therefore speaks to the serving of the "epistemic imperative" (Babbie & Mouton, 2001, p. 8) of science through *objectivity* (guiding the study in such a way as to ensure a constant focus on the minimisation of error) and *rationality* (guiding the study in a way that will satisfy the concerns of mythologically knowledgeable peers). The chapter that follows will move away from the discussion on methodologically/scientifically sound research practices that are associated with the quest for knowledge and the *truth*, to a consideration of the ethical considerations applicable to this study. More specifically, Chapter 4 will explain the ethical risks involved in the quest to uncover the identities of, measures for, and ways in which the graduate leader competencies structurally combine to regulate graduate leader job performance (behaviourally interpreted), and how these were addressed in the study.

## CHAPTER 4: ETHICAL CONSIDERATIONS

### 4.1 INTRODUCTION

While it was essential to justify the study's research methodology from an epistemological perspective as was outlined in Chapter 3, due consideration must also be given to the broader context from where the research insights were drawn and to which its outputs ultimately will be transferred and applied. This is necessary as, in addition to the use of methodologically/scientifically sound research practices that are associated with the quest for knowledge and the *truth*, other factors can also influence the quality of a study and the significance of its results, such as the manner in (or reason for) which its funding is procured, relationships with individuals and groups directly affected by the research, its (social) relevance, the interests of different stakeholders and its morality as interpreted or censored by governing public institutions (e.g. Universities and the Health Professions Council of South Africa). Accordingly, a researcher is not only accountable to his discipline and peers for producing and contributing credible, thoroughly substantiated theory to the profession's ever-growing body of knowledge, but they are also responsible for protecting and (sincerely) demonstrating an overriding dedication to the interests of fellow human beings and the larger society while doing so. Given this more encompassing interpretation of what high quality research entails, a study will ultimately only be endorsed, funded and become eligible for critical acclaim, if it manages to balance pragmatic research aims and sound scientific methodologies with ethical practices that protect, advance and respect the broader society and participants' rights and welfare as well. In view of this, the chapter that follows will describe the potential sources of ethical risk that were deemed relevant to the study, the guidelines consulted in dealing with them, as well as the specific measures that were implemented to ensure that the validation of the graduate (leader) competency domain model and the PGLCQ complied with upstanding research practices and upheld the ethical ideals of science.

### 4.2 SCIENTIFIC INTEGRITY

As alluded to above, research ethics and scientific quality are interrelated concepts and ethics, like scientific rigour, can in itself even be regarded as a substantive component of good research practice (The National Committee for Research Ethics in Science and Technology, 2008). Rosenthal (1994, p. 127) elaborates on this relationship as follows:

Everything else being equal, research that is of higher scientific quality is likely to be more ethically defensible. The lower the quality of the research, the less justified we are ethically to waste research participants' time, funding agencies' money, and journals' space. The higher the quality of the research, the better invested have been the time of the research participants, the funds of the granting agency, the space of the journals, and, not least, the general investment that society has made in supporting science and its practitioners.

For a study to be of a high scientific quality, one requirement is therefore that researchers (and their supervisors and affiliated institutions) must demonstrate a high level of integrity, which essentially constitutes a domain of research ethics concerning proper conduct in support of an organised and systematic effort to expose, rather than mask or obscure the *truth*. Often cited and related examples of research protocol that can be classified under the banner of *scientific integrity* (see Table 4.1 below) include appropriate (and truthful) reference practices, responsible institutional oversight (Cox, Preto, Woodgate, & Kolopack, 2009), peer review (Hiney, 2015), restraint from plagiarism and the falsification or fabrication of data (Dooley & Kerch, 2000),

responsible data storage and protection (Van den Eynden, Corti, Woollard, Bishop, & Hortin, 2011), as well as the appropriate crediting and acknowledgement of co-authors for their contributions (Arneson, 1982).

Table 4.1

*The Scope of research ethics*

DOMAINS OF RESEARCH ETHICS	UNDERLYING VALUES
<b>INTEGRITY - Was the research methodologies appropriate and its findings true?</b>	
1. Good scientific practice, related to the quest for accurate, adequate and relevant knowledge.	<i>Academic freedom, originality, openness, trustworthiness etc.</i>
2. Self-regulation within the research community	<i>Accountability, impartiality, criticism, etc.</i>
<b>MORALITY - Was the process followed fair and its actual outcomes a wise pursuit?</b>	
3. The relationship to people who take part in the research	<i>Respect, human dignity, confidentiality, free and informed consent, etc.</i>

Reprinted from Six Domains of Research Ethics: a Heuristic Framework for the Responsible Conduct of Research, *Science and Engineering Ethics*, 8, p. 192. Copyright 2002 by Springer Link.<sup>241</sup>

Scientific integrity then, should be a 'given' and a feature of any study that claims to honour the age-old tradition of the *scientific method* as researchers need to be able to trust each other and society needs to be able to rely on science (Hiney, 2015). It can also be said that scientific integrity serves to counter the pollution and degradation of Industrial/Organisational Psychology literature (Pitak-Arnnop, Schouman, Hervé, & Bertrand, 2008) and is therefore vital in preserving the cumulative cycle of science, which typically moves forward in small increments by building progressively on the earlier work of others (Bauer, 1992; Grinnell, 1992). The question naturally then arises as to the extent of the current study's contributions, given these proud and virtuous traditions? While these matters have not been explicitly dealt with before, the researcher nonetheless contends that the entire research dissertation, its bibliography, appendices, footnotes and other descriptive content (including the database), as well as the dialogue involved in contact sessions with stakeholders and parties of interest before and during the course of the study, encapsulates this principle and attests to the intense intellectual engagement with which 'good science' was prioritised. Accordingly, it is suggested that the arguments presented in Chapters 1 to 3 (Introduction and Research Objectives, Literature Study and Research Methodology), 5 (Research Results) and 6 (Discussion and Conclusion) as well as in the relevant appendices, footnotes, tables and figures collectively demonstrate the necessary academic and scientific merit in assuring the reader that the procedures followed and the eventual results obtained in the study was in fact, authentic. The counter fact of this is also true as in areas where insight was lacking; this was freely acknowledged as shortcomings that were singled out for debate. Integrity was further maintained from a data capturing and usage perspective as the information collected from SAGEA member representatives in the qualitative part of the study was faithfully recorded,<sup>242</sup> while the data extracted from completed PGLCQ questionnaires was inputted and utilised 'as is' in the subsequent statistical analysis.<sup>243</sup> In addition, the editing of the document itself adhered to principles of scientific integrity, as well in that the study's author and

<sup>241</sup> Although the robustness of this framework is debatable (i.e. depending on the context, the dissemination of data for example, can be categorised under both the integrity and morality domains), it nonetheless sufficed for partitioning all of the pertinent issues in allowing for a comprehensive review of the pitfalls that could undermine the ethical standards of the study.

<sup>242</sup> Interviews with SAGEA member representatives was recorded and subsequently transcribed. Both the recordings and transcripts are available for review upon request, should examiners want to verify that the transcription process was completed faithfully.

<sup>243</sup> The original data set utilised in the study is available on a secure server and can be made available upon request to examiners that want to confirm its authenticity.

the sources cited within were properly credited and referenced,<sup>244</sup> an unbiased and academic writing style was employed, and the originality of the work was formally declared.<sup>245</sup>

Moreover, as the University of Stellenbosch is a world-renowned research institution, fellowship to this establishment ensured responsible institutional oversight in matters such as peer review,<sup>246</sup> false/misrepresented information and the originality<sup>247</sup> of the work. As part of this oversight, a highly experienced and respected supervisor who has successfully completed numerous studies<sup>248</sup> on competency modelling furthermore assisted, mentored and supervised the researcher throughout, a fact that should further substantiate the claim of the scientific integrity of the study. Given this balance of evidence, the breadth of the analysis and discussion of the study's results that will follow in Chapter 5, and the openness with which reviewers are invited to inspect the research records (i.e. verify data, findings, statistical analyses, references and the originality of the work),<sup>249</sup> the researcher therefore did not deem it necessary here to further elaborate on the *truthfulness* of the study's findings. However, as the *morality* of the study has up until now not been the subject of scrutiny, the researcher still had the obligation to deconstruct this particular domain of research ethics for the reader/examiner and explain how effective 'beginning-to-end' ethical acquiescence and responsiveness was built into the research protocol from this perspective in more detail.

### 4.3 SCIENTIFIC MORALITY

The morality dimension represents the balance of a researcher's ethical obligations and deals with decisions and conduct that are 'detached' from strictly scientific considerations. It answers the questions as to what extent the research procedures were *fair* to those from whom knowledge was extracted and whether the study's intended outcomes (and eventual impact) was a *worthwhile* pursuit.<sup>250</sup> This moves the discussion away from traditional research-orientated obligations that are integral to the functional study parameters and the research community itself, to *value-laden science* (Lekka-Kowalik, 2010), which is based on the premise that technologies/knowledge created by research and the way in which this is done should be morally permissible as well. The growing consensus that science cannot be value-free<sup>251</sup> (e.g. Aggazi, 2004; Ziman, 1998) directs attention to the fact that even the 'purest', most basic research study is "endowed with potential human consequences" and therefore, that it is a scientific obligation to consider the possible implications of obtaining (and disseminating) research results, developing certain technologies, or introducing new knowledge (Lekka-Kowalik, 2010, p. 40). In reflecting on this and how, during the course of the validation of the graduate (leader) competency domain model and PGLCQ, the researcher could enrich knowledge on high-performance leadership in the graduate trainee population, how his actions could interact with society (or the graduate recruitment/development fraternity) and possibly alter it (Grinbaum &

<sup>244</sup> The researcher used the editorial style as specified by the Department of Industrial Psychology Department (i.e. the American Psychological Association guidelines) of the University of Stellenbosch.

<sup>245</sup> The declaration attached to the title page of this document confirms the researcher's pledge that he has not (purposefully) plagiarised the work of others and offered it in the document as his own.

<sup>246</sup> For example, a proposal for the research was presented to the Department of Industrial Psychology for their input and acceptance before commencement of the study. The researcher also invited further input/critique by presenting his findings and progress to other GEM scholars at workshops that were organised by the University's Graduate School programme.

<sup>247</sup> Turnitin software was utilised as a further safeguard against accidental plagiarism.

<sup>248</sup> E.g. see Botes, 2017, Chikampa, 2013, Fourie, 2015, Myburgh, 2013 and Seland, 2017.

<sup>249</sup> The review process assumes that scientific peers will examine the evidence presented as part of the normal course of scientific inquiry.

<sup>250</sup> Concern for the former gained prominence because of the universal acknowledgement that research participants deserve better protection from scientists after the Nuremberg trials (Vollman & Winau, 1996), while the latter is a another more contemporary development in response to increased awareness of how technological advances can impact society and future generations and how underlying power struggles in research can negatively impact on social justice and equality (Lekka-Kowalik, 2010).

<sup>251</sup> This argument holds that researchers can no longer claim that "science proposes, society disposes" (Lekka-Kowalik, 2010, p. 34) and dissociate themselves from the consequences of their research.

Groves, cited in Bessant, Heintz, & Owen, 2013), two themes emerged that were in critical need of moral redress.

The first theme concerns the participants to the study and how disturbances to the social fabric in their places of work through their involvement (i.e. providing intellectual capital and information about work performance) could inflict potential harm on them. The second theme concerns the knowledge generated by the study and whether the benefits of this knowledge outweighed the risks associated with its generation, disclosure or publication. To properly address these themes and expound all of the key issues at play here, it was necessary to draw from a conceptual framework of ethical principles undergirding scientific morality that could guide the researcher in this endeavour. Tom Beauchamp and Jim Childress (2009) popularised a comprehensive code (i.e. *principlism*) relevant to this discussion with which researchers can make justified moral decisions and evaluate the morality of their decisions. These four principles<sup>252</sup> are: 1) respect for autonomy (i.e. the obligation to respect the decision-making capacities of autonomous persons); 2) non-maleficence (i.e. the obligation to avoid causing harm); 3) justice (the obligation of fairness in the distribution of benefits and risks); and 4) beneficence (the obligation to provide benefits and to balance benefits against harm). The authors argue that these principles, if properly applied, will stand the test of time, cover the full range of moral concerns and hence that they represent one excellent set of criteria for censoring the morality of any scientific research. Rather than providing a formal decision-making model, *principlism* thus offers “broad philosophical constructs” (Nagy, 2000, p. 5) for guiding scientific conduct on the premise that none of these principles is generally assumed to be superior to any other (Beauchamp & Childress, 2009), yet the violation of any one of them is considered to be *prima facie* binding (Ebbesen, Anderson, & Pedersen, 2012). A more in-depth discussion on how these principles were applied in gaining awareness of possible ethical challenges that the researcher could encounter during the course of the current study is presented below.

#### 4.3.1 ETHICAL RISKS IN DEALING WITH HUMAN PARTICIPANTS

The treatment of human participants in research is of specific importance in the social sciences as researchers in this field explicitly focus on the observation and measurement of phenomena that require the active or passive involvement of human beings (Du Toit, 2014), and therefore a great degree of sensitivity is required to protect participants from any potential psychological, social, economic, or legal harm. Moreover, proper consideration has to be given to the dignity, rights, interests, safety and general well-being of participants (Du Toit, 2014), in order to expedite respectful, trusting relationships that are necessary for preserving the honour and goodwill in industry necessary for future collaboration (Lee, 2016). Finally, “good psychological research is only possible if there is mutual respect and trust” (British Psychological Society, 2010, p. 4) between the investigator and participants, and the conditions that ethical rigour (i.e. care and respect) brings about often expedites such productive relations.

Beauchamp and Childress (2009) encapsulate proper conduct for the treatment of human participants in research under the first two principles of their framework, namely respect for autonomy and non-maleficence. In reflecting on how these principles apply to moral dilemmas that could arise during the course of the researcher’s contact with SAGEA member representatives and graduate trainees, a number of concerns became evident and deserved further exploration. Firstly, the respect for autonomy principle raised the concern that graduate trainees and SAGEA member organisations would not necessarily want to participate in the research and that it would be morally unethical to force, inappropriately incentivise or deceive anyone in the study population into participation under false pretences despite the researcher’s

---

<sup>252</sup> According to Macfarlane (2009), the principles of justice, beneficence and respect for persons moreover appear in the research ethics guidelines of many countries and institutions. As such, they can be regarded as consensus standards that have been codified into research protocol over the years (Derenzo & Moss, 2006), as a result of what has or has not, worked well.

reliance on data. As employees, the graduate trainees were also considered to be vulnerable to potential coercion, because if SAGEA member organisations provided institutional permission to participate in the study, some graduates could have interpreted this as a directive from senior management that they had no choice but to obey (Lindorff, 2010). The conditions under which the study could continue, while preserving the participants' rights as self-regulating individuals, therefore firstly required careful forethought and deliberation.

Secondly, it was evident that the study would place an unnecessary burden on research participants in terms of time, effort and the possible disturbance of social fabric in their places of work. Hence, the decision to continue with the study would have technically violated the principle of non-maleficence. While the definition of what constitutes harm is often contested (Beauchamp & Childress, 2009), harm was nevertheless implied here as the completion of the PGLCQ essentially constituted a type of informal *performance review* and the possibility of subsequent embarrassment, stress, and loss of social status or confidentiality for graduates that naturally flows from threats to continued employment or promotion prospects, certainly necessitated a great deal of precaution. Dealing with the participation of SAGEA member representatives likewise necessitated a great deal of sensitivity as the disclosure of their organisations' intellectual property could have left them vulnerable to institutional reprisal and put in jeopardy their working relationships with their peers, subordinates, and senior management teams. Accordingly, a second central topic of ethical debate was the ways in which the researcher could conduct the study in a manner that would minimise (and preferably eliminate) participant fear and anxiety, and safeguard them from institutional harm, both during data collection and when circulating or publishing the study's results.

#### 4.3.2 ETHICAL RISKS IN SERVING THE COMMON GOOD

Arguably the most fundamental ethical justification for research is ultimately the question as to whether a study will provide substantial benefits to scientific understanding or to policy and/or practice in improving the fate of society as a whole, (i.e. the 'common good') without overriding the interests of individuals (both in general and those participating in the study) in doing so<sup>253</sup> (Lindorff, 2010). Beauchamp and Childress (2009) encapsulate this aspect of scientific morality under their principles of justice and beneficence, and while its application might seem like a perfectly straightforward exercise in theory, it often requires a rather complicated trade-off in practice that involves the weighing of potential costs and benefits and the careful calculation of the probability of different outcomes occurring at various stages of research. With regard to the principle of beneficence specifically, the burden of evidence also comes into play as Lekka-Kowalik (2010, p. 37) explains:

To give an example: a hypothesis that a certain substance is not lethal poison for human organisms requires stronger evidence than a hypothesis that a certain kind of flower grows only in the Alps, precisely because the moral weight of consequences of making a cognitive error in the first case – i.e. killing a person by administering the substance investigated – is greater than the moral weight of imaginable consequences of being mistaken about the place of finding a particular kind of flower.

Of course, and as is also the case in the current study, not all ethical implications of research are as dire as that associated with the first hypothesis cited above (nor as trivial as the second). The critical point to grasp, however, is that in deciding to proceed with the testing of a hypothesis, moral questions will arise (even very far 'downstream') as it will inevitably, somehow and at some time, affect (the welfare of) others. In reflecting on this and how Beauchamp and Childress' (2009) principles apply to moral dilemmas that could arise within the confines of the current study's parameters, a number of concerns relating to the 'common good' also became evident. For

---

<sup>253</sup> Although this principle emanated from a medical perspective that came about as a direct result of the Nuremberg trials (Macfarlane, 2009), there is no argument to suggest that it is less valid for non-medical research studies (Lindorff, 2010).



example, scrutiny of the justice principle raised the awareness that the researcher should act with impartiality and fairness in ensuring that comparable individuals and groups within the SAGEA graduate recruitment fraternity shared equally in the study's benefits and burdens (Beauchamp & Childress, 2009). Accordingly, the question was broached as to the fairness of the study's sampling strategy and whether the burden that the study imposed on sampled SAGEA member role-players was justified in generating a high-performance leadership research base that benefited the entire SAGEA graduate recruitment fraternity. From a social equality perspective, both unfair inclusion to and exclusion from the study was deemed a morally indefensible sampling shortcoming as the former constitutes preferential treatment, while the latter suggests discriminatory bias.

In analysing the implications of this principle further, it moreover become clear that the SAGEA graduate recruitment fraternity's involvement in the validation of the graduate leader competency domain model and the PGLCQ (i.e. the use of their intellectual capital) entitled them to stake a claim on the study's research base and the PGLCQ instrument. Under the banner of the principle of justice the researcher therefore could not deny constituents of the SAGEA graduate recruitment fraternity access to the knowledge generated throughout the study, and had to apply careful foresight in contemplating prior agreements over intellectual property rights, how results could be distributed fairly, and how the PGLCQ (if/when validated) could be commercially 're-fitted' for industry-wide consumption<sup>254</sup>. In reflecting on how the principle of beneficence applies to the current study, on the other hand, the focus shifted to 'doing good' and to what extent the validation of the graduate leader competency domain model and the PGLCQ would further the legitimate interests of society as well as research participants (i.e. graduate trainees, SAGEA member representatives and SAGEA member organisations) given the inevitability of (minimal) risks associated with any form of research (Beauchamp & Childress, 1979). The duty imposed on the researcher here was to ensure that the objectives of the study were consistent with the research agenda of the South African industry and that the extent of the graduate employability problem as well as the need for valid leadership performance theory in the country outweighed the imaginable harm that could be inflicted upon individuals or parties that stood to gain from this endeavour. It follows that in a case where the researcher would have left the research participants and the greater community no better off at the end of the study than at the beginning thereof, the principle of beneficence would have been violated (Welfel, 2010).

#### **4.4 ETHICAL STRATEGIES**

While providing insight into the researcher's obligations, these principles, however, along with the concerns expressed on the imaginable consequences that the study could have for the SAGEA graduate recruitment fraternity and society as a whole, offered no practical guidelines as to specific ethical measures that could be co-opted for the purpose of validating the graduate leader competency domain model and the PGLCQ. In a bid to resolve this impasse, the researcher 'cast a wide net' in order to familiarise himself with what is considered to be good practice. In this regard, it is important to acknowledge two broad policy areas that influenced the researcher's eventual conduct and underlying approach, namely: 1) legislative requirements; and 2) institutional requirements, both of which will be explained in more detail below.

---

<sup>254</sup> In contemplating how the PGLCQ could be commercialised the fact will need to be taken into account that the instrument is the intellectual property of Stellenbosch University.

#### 4.4.1 LEGISLATIVE REQUIREMENTS

While legislative requirements do provide impetus to ethical conduct in research around the world, in South Africa specifically, there is unfortunately no comprehensive, one-stop guide for dealing with research involving human participants in the South African governmental framework (Horn, Graham Prozesky & Theron, 2015) to guide the Organisational Psychology profession in this endeavour. The absence of a unified legislative framework on ethics thus necessitated the researcher to glean from several pieces/sections of legislature that were available in the public domain for this purpose.

##### 4.4.1.1 The Health Professions Council of South Africa: Ethical rules of conduct

The Ethical Rules of Conduct for Practitioners Registered under the Health Professions Act (Act 56 of 1974) (Republic of South Africa, 2006), for example, offered some useful input, most notably on matters pertaining to participant consent, institutional (i.e. SAGEA member organisation) approval and the disclosure of confidential information. The Health Professions Council of South Africa (HPCSA) is a statutory body that regulates the health professions in South Africa (including Organisational Psychology) and this bestows upon them the right to formally challenge any registered (or in-training) (Organisational/Industrial) psychologist under their jurisdiction that does not abide to these above-mentioned requirements in their work/training, where non-compliance could lead to a number of sanctions and ultimately even expulsion from the Board's membership register.

As regarding **participant consent** to research, Annexure 12 states that:

89.

(1) A psychologist shall use language that is reasonably understandable to the research participant concerned in obtaining his or her informed consent.

(2) Informed consent referred to in subrule (1) shall be appropriately documented, and in obtaining such consent the psychologist shall –

(a) inform the participant of the nature of the research;

(b) inform the participant that he or she is free to participate or decline to participate in or to withdraw from the research;

(c) explain the foreseeable consequences of declining or withdrawing;

(d) inform the participant of significant factors that may be expected to influence his or her willingness to participate (such as risks, discomfort, adverse effects or exceptions to the requirement of confidentiality);

(e) explain any other matters about which the participant enquires;

(f) when conducting research with a research participant such as a student or subordinate, take special care to protect such participant from the adverse consequences of declining or withdrawing from participation;

(g) when research participation is a course requirement or opportunity for extra credit, give a participant the choice of equitable alternative activities; and

(h) in the case of a person who is legally incapable of giving informed consent, nevertheless –

(i) provide an appropriate explanation;

(ii) obtain the participants assent; and

(iii) obtain appropriate permission from a person legally authorized to give such permission.

As regarding **institutional consent**, on the other hand, Annexure 12 states that:

87. A psychologist shall –

(a) obtain written approval from the host institution or organisation concerned prior to conducting research;

(b) provide the host institution or organisation with accurate information about his or her research proposal; and

(c) conduct research in accordance with the research protocol approved by the institution or organisation concerned.

Finally, as regarding the **disclosure of confidential information**, Annexure 12 states that:

27. A psychologist may disclose confidential information-
- (a) only with the permission of the client concerned;
  - (b) when permitted by law to do so for a legitimate purposes, such as providing a client with the professional services required;
  - (c) to appropriate professionals and then for strictly professional purposes only;
  - (d) to protect a client or other persons from harm;
  - (e) to obtain payment for a psychological service, in which instance disclosure is limited to the minimum necessary to achieve that purpose.

#### 4.4.1.2 The Department of Health: The National Health Act of South Africa

South Africa's National Health Act (Act 61 Of 2003) aims to provide a framework for a structured and uniform health system within the country and for governing the management of all health services by way of national guidelines, norms and standards through which healthcare services must address questions of health policy and deliver quality health services. The Act outlines in detail a number of compliance procedures for health providers in terms of cloning, the control of blood, the donation of human organs and post-mortem examinations. Even though the predominant focus of South Africa's National Health Act (Act 61 of 2003) is thus on the field of clinical medicine,<sup>255</sup> a critical review of this document yielded some universal insights on ethics that can be applied to psychological research practices as well. These selectively extracted themes are conceptually similar to those stipulated in the HPCSA's guidelines and are (Department of Health, 2013):

- a) User consent: A health care provider<sup>256</sup> may not be provided to a user without consent;
- b) Information: A user<sup>257</sup> must be informed of the objectives of and methodologies undergirding the research or experimentation and any possible positive or negative consequences on his or her health;<sup>258</sup>
- c) Refusal: It is the user's right to refuse health care or withdraw from it without prejudice;
- d) Confidentiality: All information<sup>259</sup> concerning or provided by a user must be kept confidential;
- e) Protection of records: A health care provider in possession of a user's records<sup>260</sup> must set up control measures to prevent unauthorised access to this;
- f) Conflict of interests: Providers must declare any source of funding for a study; and
- g) Feedback: Research results should be timeously disseminated to all relevant parties and stakeholders.

The overarching concerns as implied by the HPCSA's ethical rules and country's National Health Act point to the fact that researchers should ensure that the parties are fully informed as to the nature of the research and implications of participation, that the parties are given a choice as to whether or not to participate (and an explicit guarantee that non-participation carries no repercussions), that the parties are given a guarantee of confidentiality and anonymity if they participate (and are given an expectation as to their entitlement to share in the results and when results will be made available), and that this agreement and participant consent be duly captured

---

<sup>255</sup> Nonetheless, the field of Industrial/Organisational Psychology is formally classified as a Health profession and therefore in principle falls under the auspices of this Act as well.

<sup>256</sup> In this context, 'health care provider' refers to an Industrial/Organisational Psychologist's research services.

<sup>257</sup> In this context, 'user' refers to a research participant.

<sup>258</sup> In this context, 'health' refers to physical and psychological well-being.

<sup>259</sup> In this context, 'information' refers to biographical information and intellectual capital.

<sup>260</sup> In this context, 'user records' refer to the completed PGLCQs and the recordings (and consequent transcripts) made during the qualitative part of the study.

(and secured) on record. These concerns and the ways in which the researcher dealt with them are explained in more detail in Table 4.2 below.<sup>261</sup>

---

<sup>261</sup> In supplementation to this, a copy of the informed consent form that was used when sending the electronic PGLCQs to participants is available for inspection under Appendix A and B, while a copy of the institutional permission form that was sent to SAGEA member organisations before commencement of research is available under Appendix D.

Table 4.2

*Strategies for abiding with HPCSA and National Health Act research ethics guidelines*

<b>HPCSA REQUIREMENT</b>	<b>MORAL PRINCIPLE</b>	<b>ETHICAL SAFEGUARD</b>
Fully informed participants	Respect for autonomy	A formal statement of research objectives, the procedures involved and the ways in which data was to be handled, used and disseminated was included as part of the introduction to the PGLCQ. The same information was also communicated to participants of the Delphi and Critical Incident exercises and institutional representatives. This statement/introduction can be viewed under Appendix A. All communications (including documentation, questionnaires, emails, and interviews) was done in English, the accepted business vernacular in the country. Finally, although the researcher was awarded a three-year bursary by the University's Graduate School, this had no bearing on his research autonomy.
Free choice/ No repercussion for non-participation	Respect for autonomy	Institutional permission was arranged before commencement of the study. The informed consent forms and PGLCQ questionnaires were filtered to participants via a central point (i.e. SAGEA member representatives), but returned by each participant themselves on a voluntary and non-coerced basis. Unreturned questionnaires/informed consent forms were treated as 'missing cases'. Similarly, selected SAGEA member representatives that did not want to participate in the Delphi and Critical Incident exercises was given the option not to do so as well. The research was aimed at highly educated, competent and self-regulating employees in SAGEA member organisations and therefore did not target any vulnerable groups.
Confidentiality and Anonymity	Non- maleficence	Because the researcher needed to be able to identify manager-graduate dyads and the different industries from which the data emanated, the participants' identities and the names of the organisations they work for was requested in the biographical data section of the PGLCQ. However, all information/data was stored on a secure database to which only the researcher had access. Summary information supplied to organisations and any relevant stakeholders upon conclusion of the study was aggregated first and therefore individual participants/ SAGEA member organisations were unidentifiable in disseminated results.
Agreement captured on record	Respect for autonomy	The researcher has in his possession copies of all informed consent and institutional approval forms of research participants in electronic format. These are available for inspection upon request.

#### 4.4.2 INSTITUTIONAL REQUIREMENTS

A third legislative document that was scrutinised to inform current study's research protocol is the official policy for *Responsible Research Conduct (2013)*<sup>262</sup> as published and endorsed by the University of Stellenbosch. Although this document, strictly speaking, is not an official form of legislation that governs the conduct of all researchers in the country, the policy nonetheless covers all research conducted under the auspices of this particular institution and the researcher's affiliation to the University thus warranted due diligence and consideration. The objective of the policy is to provide a broad framework for the promotion of scientific integrity and ethical research at the University and, amongst other things, to: a) establish principles and responsibilities for research involving humans; and b) research that has possible repercussions for society and the broader environment. Although conceptually equivalent to some of the sanctions prescribed by the HPCSA's Ethical Rules of Conduct and the National Health Act, the principles in the document and the manner in which they are defined there nevertheless revealed some additional relevant criteria that were not (sufficiently) covered in the previous policy documents. More specifically, the following guidelines outlined in the SU policy were deemed relevant in addition to those prescribed by the HPCSA and the Department of Health:

##### 6.2. Justice.

The principle of justice ensures the fair distribution of both the burdens and benefits of research and is of particular relevance when research involves human participants.

##### 7.2. Social, Behavioural and Educational Research.

At SU, all research involving interaction with or observation of human subjects, or information linked to human subjects, or research involving groups of individuals, or organisations must go through a process of ethical screening and clearance. Investigators are responsible for ensuring that they obtain ethics approval for their research where applicable.

##### 7.3. All research involving human participants must comply with the following principles:

7.3.1 Be relevant to the needs and interests of the broader community;

7.3.2 Have a valid scientific methodology;<sup>263</sup>

7.3.3 Ensure that research participants are well informed about the purpose of the research and how the research results will be disseminated and have consented to participate;<sup>264</sup>

7.3.4 Ensure research participants' rights to privacy and confidentiality are protected;<sup>265</sup>

7.3.5 Ensure the fair selection of research participants;

7.3.6 Be preceded by a thorough risk-benefit analysis; and

7.3.7 Thorough care must be taken to ensure that research in communities is effectively coordinated and does not place unwarranted burden on such communities.

These requirements/concerns of the University and the ways in which the researcher dealt with them in turn, are explained in more detail in Table 4.3 below.

---

<sup>262</sup> In addition, the researcher also duly considered the University's *policy in respect of the commercial exploitation of intellectual property* (2010). This clarified the fact that the research base as well as the PGLCQ legally are the intellectual property of this institution.

<sup>263</sup> Note that this concern has been dealt with under scientific integrity in section 4.2.

<sup>264</sup> Note that this aspect has already been dealt with under Table 4.2 and will not be addressed twice.

<sup>265</sup> Note that this aspect has also already been dealt with in Table 4.2 and will also therefore not be addressed again.

Table 4.3

*Strategies for abiding with SU research ethics and policy guidelines*

<b>SU REQUIREMENT</b>	<b>MORAL PRINCIPLE</b>	<b>ETHICAL SAFEGUARD</b>
<b>Justice</b>	<b>JUSTICE</b>	The study's results were shared with all in the public domain immediately upon conclusion of the research and therefore did not directly benefit (or deprive) any particular party or portion of the study population. The researcher plans to patent an instrument based on this research at a later stage for providing formative feedback on graduate leadership development in industry but only in the case that the graduate (leader) competency model and PGLCQ can be validated. When a decision is made to proceed with this idea, the researcher will consult and abide by the University's policy in respect of the commercial exploitation of intellectual property.
<b>Ethical clearance</b>	<b>BENEFICENCE</b>	A request for ethical approval and clearance was duly submitted to the Research Ethics Committee Human Research (Humanities) of Stellenbosch University.
<b>Be relevant to the needs and interests of the broader community.</b>	<b>BENEFICENCE</b>	A comprehensive motivation outlining the importance and relevance of the study to the South African context was provided in Chapter 1. The potential benefits of the validation of the graduate (leader) competency domain model and the PGLCQ is moreover evident at an individual, organisational and societal level. The knowledge produced through the study would not simply add theory to the body of knowledge of the profession but has direct practical applications for the recruitment, development and optimisation of graduate (leader) talent in organisations.
<b>Ensure the fair selection of research participants</b>	<b>JUSTICE</b>	All SAGEA member organisations as well as the graduates they employ had an equal chance of selection for participation in the study. The logic of the probability sampling procedure is outlined in Chapter 3 hence was considered satisfactory for this purpose.
<b>Be preceded by a thorough risk-benefit analysis</b>	<b>BENEFICENCE</b>	See section 4.5.
<b>Well-coordinated research that does not place an unwarranted burden on communities</b>	<b>NON-MALNEFICENCE</b>	Measures were taken to relieve the burden of contact sessions and filling in a time-consuming questionnaire. This was done by using online surveys for both the Delphi exercise and the completion of the PGLCQ, and using the minimum number of items for the latter that would still provide good psychometric quality.

#### 4.5 RISK-BENEFIT ANALYSIS

In summary and as mentioned before, a requirement stipulated in the policy on *Responsible Research Conduct* by the University of Stellenbosch is that all research involving interaction with or the observation of human subjects, or research involving groups of individuals or organisations must be preceded by a risk-benefit analysis. It is the opinion of the researcher, on the face of the evidence led in the preceding paragraphs, that none of the principles of scientific morality would be (grossly) violated during the course of the intended study and that the validation of the graduate (leader) competency domain model and the PGLCQ therefore favourably meets all of the requirements of such a risk-benefits analysis. This opinion was substantiated as follows:

- As the current study's underlying research objectives were consistent with the research agendas of the South African public as well as the South African graduate recruitment fraternity, the researcher concluded that the study's intent was of a benevolent nature. In the long term, the research can realistically contribute to high-performance leadership and alleviate the graduate employability challenge, which in turn, could positively impact the country's economic growth and thus also improve the overall well-being of all citizens;
- There was no reasonable expectation that the research outputs would lead to any ill effects (apart from voluntary time and effort expended) or that its output would be susceptible to dual use,<sup>266</sup> and thus not to be at any reasonable risk of ethical censure on this basis;
- Even if the envisaged results of the study were not realised, the research would still contribute to knowledge and understanding of the nomological net underpinning high-performance graduate leadership;
- The 'moral weight' (Lekka-Kowalik, 2010) of being wrong about the psychological mechanism underpinning high-performance graduate leadership would not have resulted in any more harm than that which was already associated with participation to the study;
- Participants' rights would have been protected (i.e. by way of informed consent, institutional approval, confidentiality of information, etc.) throughout the study, and the researcher therefore did not expect any ethical complications involving institutional reprisal, breaches of confidentiality, threats to the employment and/or career prospects of graduate trainees, or their willingness to consent to the research as self-regulating individuals. In fact, there was the expectation that the SAGEA graduate recruitment fraternity would want to participate in the study in an altruistic manner, and that they would genuinely want to see the research objectives come to fruition despite possible *harm* that could be inflicted upon them in terms of time, effort, and a degree of organisational disturbance to some;
- Despite this, all possible measures would have been taken to protect participants from potential psychological, social or legal harm during the research and after the circulation of the study's results;
- Technology would moreover be utilised to minimise the relatively small degree of imaginable harm by relieving the burden associated with the time and effort required to participate in qualitative exercises and to complete the PGLCQ;
- The probability sampling strategy (i.e. all elements in the study population had an equal chance of selection) that was to be employed served to dispel concerns about the fairness of the burden/benefit ratio of participation; and
- The research dissertation was expected to be published and its theoretical implications communicated to the SAGEA graduate recruitment fraternity, ensuring that no party or

---

<sup>266</sup> The so-called '*dual-use dilemma*' arises in the context of research... as a consequence of the fact that one and the same piece of scientific research sometimes has the potential to be used for harm as well as for good" (Miller & Selgelid, 2007, p. 524).



portion of the study population would be deprived of these insights in satisfying a further concern about the fairness of the burden/benefit ratio of participation.

#### **4.6 CONCLUSION**

This chapter provided an overview of the ethical risks involved when dealing with human participants in research, the ethical risks involved for researchers in serving the common good, and how these risks applied to the current study's context. The chapter also described the ethical strategies that the researcher employed in order to minimise and neutralise the ethical risks pertinent to the investigation of the graduate leader performance construct (behaviourally interpreted) and the PGLCQ. The chapter closed with a risk-benefit analysis concluding that none of the principles of scientific morality would be (grossly) violated during the course of the intended study. The following chapter describes the result of the various phases of the study. Chapter 5 provides demographic information on the qualitative and quantitative samples employed in the sample, and a summary of the results of the Delphi method and Critical Incident exercise. The chapter also covers the item and dimensionality analyses for the PGLCQ scales, and the psychometric evaluation of the PGLCQ measurement- and comprehensive graduate leader performance LISREL models.

## CHAPTER 5: RESEARCH RESULTS

### 5.1 INTRODUCTION

Based on the generic *graduate leader* structural performance model that was developed in Chapter 2 and as is depicted in Figure 2.16, the overarching substantive hypothesis of this study is that the PGLCQ provides a reliable and construct valid measure of the generic graduate leader (behavioural) competency domain. In Chapter 2 it was also argued that this overarching hypothesis essentially encapsulates two deeper claims:

- Hypothesis 1a: The measurement model reflecting the constitutive definition of the graduate leader performance construct (interpreted behaviourally) and the design intent of the PGLCQ provides a valid account of the psychological mechanism that regulates test-takers responses to the items of the PGLCQ; and
- Hypothesis 1b: The structural model implied by the connotative meaning of the graduate leader performance construct (interpreted behaviourally) as expressed by the internal structure assigned to the construct taken in conjunction with the design intent of the PGLCQ provides a valid account of the psychological processes underpinning the level of performance that graduates attain on the behavioural components of the graduate leader performance construct (i.e. on the second-order graduate leader competencies).

In order to systematically evaluate these claims it was necessary, in turn, to further dissect these 2 sub-hypotheses into 8 operational hypotheses, of which operational hypotheses 1–5 relate to the comprehensive evaluation of sub-hypothesis 1a, and operational hypotheses 6–8 relate to the comprehensive evaluation of sub-hypothesis 1b respectively. Next, Chapter 3 outlined the methodologies proposed for use in evaluating the totality of the study's hypotheses and thus for systematically validating the construct-referenced inferences on *graduate leader* performance (behaviourally interpreted), derived from the dimension scores obtained on the PGLCQ. The following chapter will present and examine the eventual research results obtained from the study. More specifically, the chapter will present the results of the demographic characteristics of the sample group, the distribution of the missing values across the items of the PGLCQ and the procedure for how missing values were treated, as well as the psychometric properties of the PGLCQ. In addition, the chapter will present the results of the measurement model analysis as well as the evaluation of the structural model fit and the parameter estimates.

### 5.2 DEVELOPMENT OF THE PGLCQ

In order to test the study's two sub-hypotheses as outlined above, a valid and reliable measurement instrument had to be developed that could be used to derive construct-referenced inferences on graduate leaders' standing on the nine explicated second-order competencies. As the initial plan was to collect multi-rater data on the graduate leader performance construct, the researcher consequently set out to develop two versions (self-rater and other-rater) of the PGLCQ. The self-rater version of the PGLCQ was developed first and for this purpose, the researcher utilised the input from a number of South African private sector managers that are experienced in, and knowledgeable about, graduate (leaders-in-training) participating in graduate development programmes offered by private sector organisations in South Africa. The subject matter experts' opinions regarding the relevance of the nine second-order competencies that were explicated in Chapter 2 and their experience with regards to specific examples of behaviours they have witnessed and that represent a high or a low standing on each of these second-order competencies were of particular importance to the researcher. The other-rater version of the instrument was developed afterwards, based on the self-rater prototype, and was

simply a revised form of the self-rater instrument reworded from the perspective of the graduate's manager or supervisor.

### 5.2.1 QUALITATIVE ANALYSIS: SAMPLE GROUP

For the qualitative analysis, the researcher approached the SAGEA executive committee, who in turn, were asked to send out a communication to all of their member organisations requesting them to participate in a qualitative study on graduate leader performance (see Appendix D for the institutional permission form that was used for this purpose). Initially, there were no representatives from SAGEA member organisations that voluntarily responded to this request. The researcher thus regretfully had to take it upon himself to personally approach certain selected representatives of SAGEA member organisations whom he felt were the most eminently qualified to evaluate the connotative meaning attached to the graduate leader performance construct and whom he thought were the most knowledgeable subject matter experts in this field. Furthermore, all representatives targeted in this way had at least two years' experience working with, recruiting, developing and/or managing graduates and were working at organisations that:

- 1) Had employed at least 20 graduates every year for the past five years and planned on continuing to do so for the near future; and
- 2) Run a formal leadership acceleration programme for their graduates.

Ultimately, the researcher managed to secure the commitment of 12 SAGEA<sup>267</sup> member organisation representatives for the study's qualitative analysis that fitted the requirements as outlined above. Amongst these participants were a Talent Manager, a Leadership Development Programme Manager, two Graduate Placement Officers, two Graduate Recruitment Managers, two Graduate Recruitment Consultants, a Head of Recruitment, a SAGEA Executive Committee member, and two Graduate Mentors.<sup>268</sup>

### 5.2.2 DELPHI RESULTS

The first round of the Delphi exercise was conducted by way of a structured questionnaire (via SurveyMonkey)<sup>269</sup> that was emailed to the SAGEA member representatives who consented to participate in the qualitative analysis (see Appendix E). As per the emailed instructions, the panellists were required to rate the importance of the nine explicated second-order (graduate) leader competencies and state/motivate the rationale for their assigned ratings. Panellists were provided with the constitutive definitions of each second-order graduate leader competency. Panellists were also provided with the definitions of the first-order competencies that 'load' onto each second-order competency to help more clearly describe the breadth of the second-order competencies. All second-order leadership competencies were rated by making use of a five-point Likert scale<sup>270</sup>. The ratings assigned to each second-order graduate leader competency are presented in Table 5.1 and the descriptive statistics of the assigned ratings in Table 5.2. In order to confirm the relevance of the second-order competency dimensions that were lined up for inclusion in the PGLCQ, panellists had to affirm and reach consensus on a rating of at least 3 for each second-order graduate leader competency.

---

<sup>267</sup> SAGEA member representatives seemingly loathed the idea of participating in the research and the researcher could unfortunately not get 15 participants as was initially planned.

<sup>268</sup> As the panellists participated under the guarantee of anonymity, their names and the identities of their organisations cannot be disclosed here.

<sup>269</sup> SurveyMonkey is a free online survey tool.

<sup>270</sup> The rating scale was coded as follows: 1 = Irrelevant, 2 = Marginally relevant, 3 = Relevant, 4 = Moderately relevant, 5 = Highly relevant.

Table 5.1

*Delphi exercise: ratings assigned to the graduate leader competencies*

	P1 <sup>271</sup>	P2	P3	P4	P5	P6	P7	P8	P9	P10	P11	P12
Comp_A	5	5	3	5	5	5	5	5	5	5	3	4
Comp_B	5	3	3	5	3	4	5	5	5	5	5	4
Comp_C	4	5	4	5	4	5	4	4	4	5	4	5
Comp_D	5	5	3	5	3	5	5	5	4	5	5	5
Comp_E	5	3	3	5	5	3	3	3	3	4	4	4
Comp_F	5	5	3	5	3	5	4	4	4	4	5	4
Comp_G	5	3	3	5	4	5	4	3	4	4	5	4
Comp_H	5	5	4	5	4	5	4	5	4	5	4	4
Comp_I	3	5	3	5	3	4	3	5	3	4	4	4

Note: Comp\_A refers to the *displays personal leader proficiency* variable (COMP\_A); Comp\_B refers to the *analyses and understands the external and internal work unit environment* variable (COMP\_B); Comp\_C refers to the *creates an exciting and aspirational vision for the unit* latent variable (COMP\_C); Comp\_D refers to the *entrenches a high-performance culture in the unit* latent variable (COMP\_D); Comp\_E refers to the *develops unit competitiveness* latent variable (COMP\_E); Comp\_F refers to the *involves others and elicits participation* latent variable (COMP\_F); Comp\_G refers to the *unites and connects followers* latent variable (COMP\_G); Comp\_H refers to the *strengthens and enables followers* latent variable (COMP\_H); and Comp\_I refers to the *manages the internal work unit environment* latent variable (COMP\_I). P<sub>i</sub> refers to the <sup>i</sup>th panellist.

Table 5.2

*Delphi exercise round one: Descriptive statistics*

	Minimum	Maximum	Mode	Mean	Std. Deviation
Comp_A	3	5	5	4.583	0.792
Comp_B	3	5	5	4.333	0.887
Comp_C	4	5	4	4.416	0.514
Comp_D	3	5	5	4.583	0.792
Comp_E	3	5	3	3.750	0.866
Comp_F	3	5	4/5	4.250	0.753
Comp_G	3	5	4	4.083	0.792
Comp_H	4	5	5	4.500	0.522
Comp_I	3	5	3	3.833	0.834

Note: Comp\_A refers to the *displays personal leader proficiency* variable (COMP\_A); Comp\_B refers to the *analyses and understands the external and internal work unit environment* variable (COMP\_B); Comp\_C refers to the *creates an exciting and aspirational vision for the unit* latent variable (COMP\_C); Comp\_D refers to the *entrenches a high-performance culture in the unit* latent variable (COMP\_D); Comp\_E refers to the *develops unit competitiveness* latent variable (COMP\_E); Comp\_F refers to the *involves others and elicits participation* latent variable (COMP\_F); Comp\_G refers to the *unites and connects followers* latent variable (COMP\_G); Comp\_H refers to the *strengthens and enables followers* latent variable (COMP\_H); and Comp\_I refers to the *manages the internal work unit environment* latent variable (COMP\_I).

As can be seen from Table 5.1, all panellists were in agreement regarding the *relevance* of all of the second-order competency dimensions as explicated in Chapter 2 right from the start as all of them assigned a rating of no less than 3 (i.e. *relevant*) to each and every competency dimension. In fact, as per Table 5.2, the means for these assigned competency ratings ranged between 3.833 and 4.583 and standard deviations between .522 and .866 respectively. The findings here thus stood in overwhelming support of the applicability of these competencies for leadership (development) in the world of work. It was also apparent that Comp\_E (*develops unit competitiveness*) was deemed to be the least important of all of the relevant nine explicated second-order graduate leader competencies (mean = 3.750), while Comp\_A (*displays personal leader proficiency*), Comp\_D (*entrenches a high-performance culture in the unit*) (both means = 4.583) and Comp\_H (*strengthens and enables followers*) (mean = 4.500) were deemed to be the most relevant dimensions in the graduate leader competency set. None of the panellists indicated that they felt that the graduate leader performance construct as represented by the nine second-order competencies suffered from any construct deficiency. As all panellists' ratings also fell within the acceptable consensus zone (i.e. all assigned ratings were 3 or more with no outliers towards the bottom of the distribution) after round one, the Delphi exercise, and thus the confirmation that the nine explicated graduate leader competencies are relevant leadership

<sup>271</sup> P1 refers to panellist 1, P2 to panellist 2, and so on.

(development) dimensions in the world of work (as judged by experts in the field), was considered successfully concluded.<sup>272</sup>

### 5.2.3 CRITICAL INCIDENT TECHNIQUE RESULTS

With the relevance of the nine explicated second-order graduate leader competencies confirmed, the researcher again approached and interviewed the same twelve people who participated in the Delphi exercise (see Appendix F for the template of the informed consent form that was used in this instance). This time around, the goal was to tap their knowledge on behavioural incidents that reflect a high or low standing on each of these same competency dimensions in order to develop (relevant) items for each of the different subscales of the PGLCQ via the Critical Incident Technique (CIT). The essence of the CIT involves asking participants to recall a specific incident<sup>273</sup> and to recount the incident to the observer, focusing on: 1) a detailed description of the incident; 2) a description of the actions/behaviours of those involved in the incident; and 3) the results or outcomes of the incident with the aim of capturing a detailed description of the behaviours of the participants being studied, rather than recording a generalisation or opinion about it (Victoroff & Hogan, 2006).

Accordingly, the participating subject matter experts for this study were referred to a specific, second-order graduate leader competency that was identified through the literature study, and asked to think of a graduate that they consider to be one of the best performers on this competency that they know or have known. The participant was given the constitutive definition of the competency being discussed and was then asked to justify his or her choice of graduate by describing specific incidents that illustrated the graduate's competence on the competency. The subject matter expert was therefore probed for valuable information by asking the following questions:

- 1) Think of a graduate who, according to your personal assessment, is one of the best performers on the competency of XXX. The competency in question can be defined as: (Competency definition to be included here).
- 2) Please motivate your position that this graduate is highly competent on competency XXX by describing specific incidents that illustrate the individual's competence in this regard.
- 3) Please explain exactly what the graduate did and why you regard this as a good illustration of his or her competence in this area.

The resulting answers from the subject matter expert were recorded and the same line of questioning was repeated for the same competency, except this time the participant was asked to relate the same questions to a graduate they consider to be a poor or less effective performer with regards to the competency in question. This process was repeated for all of the competencies, but although all participants were probed on the entire graduate leader competency set, the majority of participants only contributed between five and seven behavioural incidents that could be translated into usable items for one or more of the PGLCQ subscales. The researcher therefore had to supplement participant input with some behavioural incidents that was based on his own work experiences and his knowledge of the study's research base, but always tested and validated these incidents with participants first.<sup>274</sup> The interviews continued until enough content was collected to cover the development of all of the PGLCQ's items (i.e. at least 10 items per subscale).

---

<sup>272</sup> The researcher sent out a summary of all the assigned ratings to all participants after round one was completed, and requested the panelists to reconsider their assigned ratings based on the ratings that were assigned by the other panelists. However, none of the participants chose to revise their initial assigned ratings.

<sup>273</sup> A critical incident is defined as an event that makes the difference between success and failure (FitzGerald et al., 2008) with regards to the theme that is being studied.

<sup>274</sup> Approximately 30% of the PGLCQ's items had to be created by following this approach.

#### 5.2.4 DESCRIPTION OF THE PGLCQ

Based on the competencies included in the (partial) competency model or hypotheses on graduate leader performance, the researcher developed an initial, experimental self-rater version of the PGLCQ. The starting point for this exercise was to utilise the specific behavioural examples supplied by subject matter experts during the preceding interviews in developing items for the subscales that were used to measure each graduate leader's competency of importance. The success with which the items were generated was considered critical in establishing the content<sup>275</sup> validity of the questionnaire (Clark & Watson, 1995), which is often viewed as the minimum requirement for sound measurement (Hinkin, 1995) and is also the first step in the construct validation<sup>276</sup> of a new measure (Schriesheim et al., 1993). Therefore, the items comprising each subscale had to describe behavioural denotations of the various latent behavioural performance dimensions (Fourie, 2015). The objective was to obtain a set of items for each subscale to provide a “relatively uncontaminated expression” (via the respondent's response to it) of the latent performance dimensions it was earmarked to reflect (Fourie, 2015, p. 87). Basic principles of item writing were also observed including the use of simple, straightforward language appropriate for the reading level of the PGLCQ's target population, as well as the avoidance of double-barrelled questions and trendy expressions and colloquialisms (Clark & Watson, 1995).

The PGLCQ ultimately consisted of nine subscales and 90 questions (10 items per subscale). All competency questions were anchored by 5-point rating scales. A sixth response option (‘cannot rate’) was also provided for cases where a rater felt that they could not provide a valid rating themselves or a direct report on a particular item. Both versions of the PGLCQ also included a number of demographical questions as well as detailed instructions and an informed consent section that participants had to agree to before completing the questionnaire (See Appendices A and B). In order to simplify the distribution of the questionnaire and the collation of participant responses, an electronic version of the PGLCQ (self-rater and other-rater) was created on the University's survey platform (SURvey) using the Checkbox software. Links to the PGLCQ were emailed to prospective participants so that they could complete the questionnaire online and all completed responses were later downloaded from the survey site and imported to SPSS and LISREL for the quantitative analyses that followed.

### 5.3 QUANTITATIVE ANALYSIS: SAMPLE GROUP DEMOGRAPHIC CHARACTERISTICS

As stated in Chapter 3, the researcher aimed to utilise a probably sampling technique for the present study, namely the two-stage cluster sampling with stratification design. This meant that the researcher had to: (1) stratify the study population (i.e. all SAGEA member organisations) into the different industries in which they operate (i.e. their core business or value chain such as *retail, banking, legal*, etc.); 2) randomly select a fixed number of primary sampling units (PSU) with a probability proportional to size for each industry/stratum; and 3) select a number of final sampling units (FSU) from the PSU, which was again to be determined by proportionality. The idea was then that a key representative (e.g. graduate recruitment manager or graduate development officer) in each PSU would assist the researcher by: 1) participating in the qualitative part of the study (i.e. the Delphi Method and the Critical Incident Technique) to vet the

<sup>275</sup> Westen and Rosenthal (2003) define content validity as the extent to which a measure adequately samples the content of the domain that constitutes the construct (i.e. do the different behavioural expressions in the scale adequately sample the performance dimension in question?).

<sup>276</sup> Cronbach and Meehl (1955) proposed that the investigation of the construct validity of a measure involves the articulation of a set of theoretical concepts and their interrelations, (i.e. the nomological net) developing ways to measure the constructs proposed by the theory, and the empirical testing of the hypothesised relations among constructs. Construct validity can be viewed as an encompassing form of validity and is defined as the extent to which a measure adequately assesses the constructs it purports to assess (Bernstein & Nunally, 1994). Construct validity is a key element in differentiating (organisational) psychology as a science from other non-scientific approaches (Clark & Watson, 1995).

second-order competencies as gleaned from the literature study and to assist in item development for the PGLCQ; and 2) by facilitating the quantitative data collection process within their organisations for their own FSU.

Unfortunately, however, not all of these ambitious aims for data collection were realised. Although twelve of the SAGEA member organisations were readily available (and gave permission) to spend time with the researcher in order to successfully complete the qualitative part of the study (i.e. the Delphi Method and Critical Incident Technique), most of them indicated that they simply did not have the time to facilitate the quantitative data collection process within their own ranks and/or were not prepared to take on this extra task as well. In addition, some Heads of Human Resources were hesitant to give their institutional permission for the study, as they felt that some employees could have viewed the quantitative data collection exercise as a type of performance review and they did not want the anxiety and stress that such reviews typically cause by disrupting the productivity of their staff. Others still were averse to lend institutional permission, as they were wary of the possibility that any of their intellectual property on graduate recruitment and development could be made public to their competitors.<sup>277</sup> Moreover, even in those organisations where the researcher did get institutional permission for the study and did get access to the FSU, quantitative data collection was marred by the multi-rater nature of the research design because in too many cases where SAGEA graduates completed the PGLCQ (self-rater version), their paired managers or supervisors declined or failed to do so (other-rater version), or vice versa, making the collection of one data point (i.e. one observation is only “complete” with both the self-rater and the other-rater completed) extremely challenging.

The fact that each graduate’s response had to be paired with that of his or her manager/supervisor also further complicated the exercise in another way because this required an understanding of each graduate’s reporting relationships before links to the PGLCQ (other rater version) could be sent to the correct superiors (i.e. managers or supervisors). The identities of those that the graduate reported to were, moreover, not always even known by the SAGEA member representatives themselves at the time when constitutional consent was being negotiated.<sup>278</sup> Ultimately, therefore, both the response rate envisaged for FSU in total as well as the specific response rates envisaged for FSU within specific industries or strata could not be achieved, and the researcher had no choice but to revert to a *convenience sampling* strategy instead. In an attempt to expedite the data collection process even more, which at the time that this decision was made had already been carrying on for 8 months, the researcher also decided to focus exclusively on collecting self-rater responses from that point onwards. This decision, in turn, had implications for the manner in which the measurement and comprehensive LISREL models were ultimately specified, in that the analysis could not proceed along the lines of a Multitrait-Multirater (MTMR) matrix as was initially planned.<sup>279</sup>

Accordingly, the sample for the quantitative phase of this study was broadened from SAGEA member graduates that are currently participating on a graduate programme to any available and willing graduates working in South Africa that are at different stages of their ‘journey towards strategic leadership’. As was argued in Chapter 2 on the discussion of the leadership strataplex, the logic underlying this decision was that base or foundation leadership competency

---

<sup>277</sup> The researcher believes that it was quite short-sighted on the side of SAGEA member organisations to not have been more enthusiastic and accommodating of this study. After all, the SAGEA member organisations could have benefited the most from a validated graduate leader performance structural model with which to inform their future graduate selection and development practices. The fact that there was a general lack of urgency from SAGEA member organisations to participate in this study was therefore, frankly, extremely disappointing.

<sup>278</sup> In many of the SAGEA member organisations, graduates are periodically moved around to different geographic locations to become part of different projects that form part of their formal training programme. The SAGEA member representatives were not always in charge of the coordination of these secondments, and not always prepared to go the extra mile in securing this information for the researcher.

<sup>279</sup> The implications of reverting to an analysis of the more typical single group, single rater, first-order measurement model will be discussed later on in this chapter.

requirements do not typically change with age, function or seniority in an organisation. Instead, it was argued that leadership effectiveness is underpinned by a set of relatively consistent competency sets having varying degrees of relevance across and requiring increased proficiency at higher organisational levels.<sup>280</sup> It should therefore not matter whether the PGLCQ was administered to SAGEA member graduates-in-training as was planned, or whether the questionnaire was administered to more senior/mature graduates that were already functioning as individual contributors, technical leaders, team leaders or strategic leaders in other organisations.

Put differently, it is not only SAGEA member graduates that participate in leadership acceleration programmes that practise or develop leadership, and leadership behaviours are also developed and manifest naturally in organisational contexts in which employees operate at different levels of leadership and where they experience “open-system” learning crucibles as part of their normal daily work lives. In fact, it can even be argued that the initial plan for exclusively surveying SAGEA member graduates-in-training was somewhat flawed, in that most of these individuals would not have had the necessary training and development or exposure to the required real-life experiences that would have allowed them (and their managers) to respond meaningfully to some of the competency items included in the PGLCQ in the first place. For example, it is doubtful if a fresh graduate-in-training would have had sufficient development in, and opportunities to demonstrate their mastery of, the competency of *develops unit competitiveness*<sup>281</sup>, which in essence can only really be meaningfully evaluated once the ratee is formally put in charge of an actual team/unit. Having more mature/senior graduates that have already progressed into more senior, impactful positions in the organisational hierarchy and that at least have some degree of real-life exposure to aspects such as business strategy formulation, business process engineering and the creation of new business opportunities respond to these questions, might have in hindsight been a more appropriate course of action. The fact that the sampling strategy was changed and the PGLCQ was ultimately administered to a broader spectrum of graduates operating at varying levels of leadership therefore did perhaps have an unforeseen advantage. However, it is thereby not implied that those competency items are wholly inappropriate for assessing the performance of graduate leaders on leadership acceleration programmes. To the extent that graduates that participate on leadership acceleration programmes have not fully developed specific competencies that need to be further honed through mentorship once employed as graduate leaders, these deficiencies need to be pointed out by the PGLCQ.

Regardless, it is duly acknowledged that this forced change to the study’s sampling strategy certainly had implications for the representativeness of the sample (Babbie, 2016) and therefore also the generalisability of the study’s findings to the general population. Nonetheless, this new sampling strategy proved to be more fruitful in terms of response rates, ultimately yielding a total of 253 responses for the self-rater version of the PGLCQ. However, only 105 of these responses were indicated as *complete* on Checkbox. Therefore, 148 self-rater responses were incomplete and not used for the purposes of this study. This relatively poor completion rate for the self-rater group prompted the question of whether or not the twenty-eight completed *other-rater* group responses that had already been collected for the study before the change in sampling strategy occurred, should be added to the sample of self-rater responses in supplementation of some of the uncompleted self-rater responses. On the one hand, one could argue that the success of the study is particularly dependent on sample size and therefore the addition of the *other-rater*

---

<sup>280</sup> It is thereby not denied that the relative importance of specific competencies might increase as one moves up the organisational hierarchy. Moreover, it is also not denied that the level of competence that leaders display on competencies might increase as a function of age, experience and hierarchical level.

<sup>281</sup> In ‘leadership strataplex’ language, this behavioural performance dimension can be categorised as a business competency requirement, and therefore only becomes relevant once the graduate leader is put in charge of the management of material- and human resources.



responses to the sample could be vindicated, as this would increase the statistical power required to sufficiently power the study's SEM procedures.<sup>282</sup>

On the other hand, the addition of other-rater responses to the self-rater responses into one sample, without analysing the data in a manner that formally acknowledges rater as a source of systematic variance, is not a methodologically optimal strategy, and is therefore subject to criticism. Acknowledgement of rater as a source of systematic variance, however, requires that all graduate leaders should have been evaluated via multi-rater assessments (as was the original intention). Nonetheless, given the challenges associated with the collection of data and incomplete responses in general, the forced decision was made to favour the statistical power yield of the sample in spite of possible methodological shortcomings that this may bring about by adding the other-rater responses (28 cases) to the self-rater responses (105 cases), resulting in a sample of 133 (n=133).

The demographic characteristics of this sample are presented in Tables 5.3 – 5.18 below. The demographic characteristics of the self-rater and other-rater samples are presented separately. Overall, the findings indicate that more males (80 cases) completed the PGLCQ than females (53 cases) and that the majority of participants were White (96 cases). Nevertheless, Black African, Coloured and Indian groups were also represented in the total sample to some extent. In addition, most of the respondents were from the Western Cape province; however, five other provinces in South Africa as well as a number of different industries in the country and study areas were also represented.

Table 5.3

*Gender representation in the self-rater group*

		Frequency	Percent	Valid Percent	Cumulative Percent
Valid	Male	55	52.4	52.4	52.4
	Female	50	47.6	47.6	100.0
	Total	105	100.0	100.0	

Table 5.4

*Gender representation in the other-rater group*

		Frequency	Percent	Valid Percent	Cumulative Percent
Valid	Male	25	89.3	89.3	89.3
	Female	3	10.7	10.7	100.0
	Total	28	100.0	100.0	

In terms gender of representation, Tables 5.3 and 5.4 indicate an approximate 50:50 split between males and females for the self-rater group, while the gender make-up for the other-rater group was heavily weighted towards male participants (approximately 90% of other-raters were male). The fact that approximately only 10% of other raters in the other-rater group were female is somewhat surprising, as despite management positions historically being reserved for males, one would have expected a larger representation of females here given current labour legislation and the universal drive for the empowerment of women. In the total sample of 133, however, 80 respondents were male and 53 female, which was regarded as an acceptable ratio.

<sup>282</sup> The researcher had to maximise sample size given the fact that he still had options at his disposal to render the measurement and comprehensive LISREL models theoretically *overidentified* – e.g. by imposing tau equivalent constraints on the measurement and comprehensive LISREL models and/or by utilising item parcels instead of single items for the analyses.

Table 5.5

*Race representation in the self-rater group*

		Frequency	Percent	Valid Percent	Cumulative Percent
Valid	Black African	15	14.3	14.3	14.3
	Coloured	14	13.3	13.3	27.6
	Indian	3	2.9	2.9	30.5
	White	73	69.5	69.5	100.0
	Total	105	100.0	100.0	

Table 5.6

*Race representation in the other-rater group*

		Frequency	Percent	Valid Percent	Cumulative Percent
Valid	Coloured	3	10.7	10.7	10.7
	Indian	2	7.1	7.1	17.9
	White	23	82.1	82.1	100.0
	Total	28	100.0	100.0	

Table 5.7

*Years of experience in managing others: other rater group*

		Frequency	Percent	Valid Percent	Cumulative Percent
Valid	0-1 Years	1	3.6	3.6	3.6
	2-5 Years	5	17.9	17.9	21.4
	6-9 Years	8	28.6	28.6	50.0
	10+ Years	14	50.0	50.0	100.0
	Total	28	100.0	100.0	

As per Tables 5.5 and 5.6, it is evident that in total, 15 Black African, 17 Coloured, 5 Indian, and 96 White respondents participated in the study. While White respondents clearly dominated participation in both the self-rater (73 cases) and other-rater (23 cases) groups and Coloureds and Indians were marginally represented in both, Black Africans were only somewhat represented in the self-rater group (15 cases) and not represented in the other-rater group at all. This finding is once again surprising, as despite ultimately resorting to a convenience sampling strategy, one would have expected Black African representation in management or supervisory positions at least to some extent given current employment legislation targeting Black empowerment in the country. Regardless of this, as can be seen from Table 5.7, the suitability of the other-rater group respondents to be able to accurately rate graduates on the PGLCQ appeared to be adequate, given that almost 79% of the respondents here indicated that they have had 6 or more years' experience in the management of people.

Table 5.8

*Home language representation in the self-rater group*

		Frequency	Percent	Valid Percent	Cumulative Percent
Valid	Afrikaans	66	62.9	62.9	62.9
	English	25	23.8	23.8	86.7
	Northern Sotho	1	1.0	1.0	87.6
	Sotho	2	1.9	1.9	89.5
	Tsonga	1	1.0	1.0	90.5
	Tswana	3	2.9	2.9	93.3
	Venda	1	1.0	1.0	94.3
	Xhosa	1	1.0	1.0	95.2
	Zulu	4	3.8	3.8	99.0
	Other	1	1.0	1.0	100.0
	Total	105	100.0	100.0	

Table 5.9

*Home language representation in the other-rater group*

		Frequency	Percent	Valid Percent	Cumulative Percent
Valid	Afrikaans	15	53.6	53.6	53.6
	English	13	46.4	46.4	100.0
	Total	28	100.0	100.0	

The results of Tables 5.8 and 5.9 indicating the home language of the sample's respondents are in line with what one would expect given the dominance of White respondents in the sample – 87% of all respondents in the self-rater group, and all respondents in the other-rater group reported Afrikaans or English as their home language. In following this trend, all African languages (Sotho, Tsonga, Zulu, etc.) were only marginally represented in the sample by accounting for only 13% of the total responses in the self-rater group.

Table 5.10

*Geographic location of respondents in the self-rater group*

		Frequency	Percent	Valid Percent	Cumulative Percent
Valid	Eastern Cape	2	1.9	1.9	1.9
	Gauteng	22	21.0	21.0	22.9
	Germany	1	1.0	1.0	23.8
	KwaZulu-Natal	1	1.0	1.0	24.8
	North West	1	1.0	1.0	25.7
	Western Cape	78	73.3	73.3	100.0
	Total	105	100.0	100.0	

Table 5.11

*Geographic location of respondents in the other-rater group*

		Frequency	Percent	Valid Percent	Cumulative Percent
Valid	Gauteng	10	35.7	35.7	35.7
	Mpumalanga	1	3.6	3.6	39.3
	North West	1	3.6	3.6	42.9
	Western Cape	16	57.1	57.1	100.0
	Total	28	100.0	100.0	

Regarding the geographic location of respondents, Tables 5.10 and 5.11 indicate that the majority of the respondents in both the self-rater (78 cases) and other-rater groups (16 cases) were from the Western Cape. These tables further indicate that a significant proportion of respondents were from Gauteng, which is the second most represented province in both the self-rater (21%) and other-rater groups (36%) respectively. The Eastern Cape, KwaZulu-Natal, North West and Mpumalanga provinces were only marginally presented in the entire sample. The sole self-rater respondent from Germany only recently moved to that country for a temporary work assignment and is actually still based in Gauteng. The dominance of respondents from the Western Cape is not surprising, as this is the location where the researcher is based and from where data collection was initiated and coordinated.

Table 5.12

*Area of study for the other-rater group*

		Frequency	Percent	Valid Percent	Cumulative Percent
Valid	Accounting	2	7.1	7.1	7.1
	Commerce	1	3.6	3.6	10.7
	Engineering	2	7.1	7.1	17.9
	Social Sciences	1	3.6	3.6	21.4
	Health Sciences	1	3.6	3.6	25.0
	Other	21	75.0	75.0	100.0
	Total	28	100.0	100.0	

Table 5.13

*Area of study for the self-rater group*

		Frequency	Percent	Valid Percent	Cumulative Percent
Valid	Accounting	9	8.6	8.6	8.6
	Commerce	36	34.3	34.3	42.9
	Engineering	7	6.7	6.7	49.5
	Social Sciences	16	15.2	15.2	64.8
	Health Sciences	2	1.9	1.9	66.7
	Other	35	33.3	33.3	100.0
	Total	105	100.0	100.0	

Table 5.14

*Industry representation for the other-rater group*

		Frequency	Percent	Valid Percent	Cumulative Percent
Valid	Retail	17	60.7	60.7	60.7
	Logistics	7	25.0	25.0	85.7
	Other	4	14.3	14.3	100.0
	Total	28	100.0	100.0	

Tables 5.12 and 5.13 cover the respondents' area of study, with the "Other" category clearly dominating the total sample, as well as both the self-rater (35 cases) and the other-rater (21 cases) groups respectively. "Other" areas of expertise included Banking, Logistics/Supply chain, Law, FMCG (fast moving consumer goods) and Insurance. Commerce is the second most represented field of study in the total sample, with 36 cases emanating from the self-rater group and only 1 case from the other-rater group. Social sciences is the third most represented field of study in the total sample (16 cases from the self-rater group and 1 case from the other-rater group), followed by Accounting (9 cases in the self-rater group and 2 cases in the other-rater group), Engineering (7 cases in the self-rater group and 2 cases in the other-rater group), and Health Sciences (2 cases from the self-rater group and 1 case from the other-rater group). Finally, as per Table 5.14 it was evident that most other-rater group respondents categorised themselves as currently working in the Retail industry (17 cases), followed by Logistics (7 cases) and "Other" (4 cases). The "Other" industry category for the other-rater group included industries other than Retail, Logistics, Media, Consulting, Capital, Energy, Banking, Mining, Manufacturing, Tech, and Research. When viewed in terms of the totality of the sample, the total distribution in terms of the reported areas of study was regarded as a strength of the sample.

Table 5.15

*Age of the other rater group*

Statistic	Value
Mean	39.79
Median	38.50
Std. Deviation	8.504
Variance	72.323
Skewness	.157
Std. Error of Skewness	.441
Kurtosis	-1.286
Std. Error of Kurtosis	.858
Range	29
Minimum	26
Maximum	55

Table 5.16

*Age of the self-rater group*

Statistic	Value
Mean	35.12
Median	34.00
Std. Deviation	9.176
Variance	84.206
Skewness	.727
Std. Error of Skewness	.236
Kurtosis	-.088
Std. Error of Kurtosis	.467
Range	40
Minimum	21
Maximum	61

Regarding the age of respondents in the sample, Tables 5.15 and 5.16 indicate that the average age of respondents in the self-rater group was 35, whilst the average age of the other rater group was 40. When viewed in combination with the highest (55 years) and lowest (26 years) reported age of respondents in the other-rater group, the average reported age for the other-rater group makes intuitive sense as managers or supervisors were expected to be somewhat older than the typical graduate trainee. The range (29) of the reported ages of the other rater group was also regarded as a strength in this part of the sample. The oldest respondent in the self-rater group was 61<sup>283</sup> and the youngest 21. The range (40) of the reported ages of the self-rater group was likewise regarded as a strength of this part of the sample.

Table 5.17

*Highest qualification of the self-rater group*

		Frequency	Percent	Valid Percent	Cumulative Percent
Valid	Diploma	17	16.2	16.2	16.2
	Bachelor's degree	18	17.1	17.1	33.3
	Honour's degree	39	37.1	37.1	70.5
	Master's degree	14	13.3	13.3	83.8
	Doctoral degree	7	6.7	6.7	90.5
	Other	10	9.5	9.5	100.0
	Total	105	100.0	100.0	

<sup>283</sup> Note that respondents of this age would not have been part of the self-rater group had the sampling population not been widened to also exclude graduate leaders that already completed the graduate development programme.

Table 5.18

*Educational institution where highest qualification was obtained: self-rater group*

	Frequency	Percent	Valid Percent	Cumulative Percent
Cape Peninsula University of Technology	10	9.5	9.5	9.5
Damelin	2	2.0	1.0	11.5
IMM Graduate School	1	1.0	1.0	12.5
Durban University of Technology	1	1.0	1.0	13.5
North West university	5	4.8	4.8	18.3
Northlink College	1	1.0	1.0	19.3
Prestige Academy	1	1.0	1.0	20.3
Regent Business School	1	1.0	1.0	21.3
SA School of Paralegal Studies	1	1.0	1.0	22.3
Teaching College Pretoria	1	1.0	1.0	23.3
Tygerberg College	1	1.0	1.0	24.3
University of South Africa	11	10.5	10.5	34.8
University of Cape Town	7	6.7	6.7	41.5
University of Johannesburg	6	5.7	5.7	47.2
University of KwaZulu-Natal	1	1.0	1.0	48.1
University of Pretoria	3	2.9	2.9	51.0
University of Stellenbosch	39	37.1	37.1	88.1
University of the Free State	5	4.8	4.8	92.9
University of the North	1	1.0	1.0	93.9
University of the Western Cape	5	4.8	4.8	97.9
University of Venda	1	1.0	1.0	98.9
Vaal University of Technology	1	1.0	1.0	100.0
Total	105	100.0	100.0	

Finally, Tables 5.17 and 5.18 point to quite a wide spectrum of responses in the self-rater group in terms of highest qualification obtained as well as the institution where their highest qualification was obtained. Participants with an Honour's degree were the most represented in the self-rater group (39 cases), followed by a Bachelor's degree (18 cases) a Diploma (17 cases), a Master's degree (14 cases) and a Doctoral degree (7 cases). Ten participants in the self-rater group opted for the "Other category" in terms of highest qualification obtained, pointing to the fact that almost 10% of the self-rater group presumably had a highest qualification lower than that of a Diploma (such as a NQF level 5 Higher Certificate or Advanced National (vocational) Certificate). Most of the respondents (approximately 60%) in the self-rater group reported that they obtained their highest qualification at educational institutions in the Western Cape (University of the Western Cape with 5 cases, University of Cape Town with 7 cases, University of Stellenbosch with 39 cases, and Cape Peninsula University of Technology with 10 cases). Again, this was not surprising as this is the location where the researcher was based and from where data collection was initiated and coordinated. Nonetheless, a variety of other educational institutions based in various provinces of the country were also represented such as the University of Johannesburg (Gauteng), Durban University of Technology and the University of KwaZulu-Natal (KwaZulu-Natal), Vaal University of Technology and North West University (North West), etc. When viewed in terms of the totality of the sample, the total distribution in terms of the reported levels of qualifications obtained as well as the educational institutions where these qualifications were obtained, was regarded as a further strength of the sample. Ultimately, therefore, while there are some valid criticisms to be made against the eventual sampling methodology that was employed and while it would have been preferable to have had greater representation of Black Africans in the total sample, it was nonetheless concluded that the total sample was sufficient in terms of size,<sup>284</sup> relevance and diversity to warrant further analyses.

<sup>284</sup> Although sufficient in size to warrant further analyses, the sample size nonetheless imposed unfortunate restrictions on the manner in which the confirmatory factor analysis and the evaluation of the structural model had to be performed.

## 5.4 MISSING VALUES

The problem of missing values in data sets is relatively common in almost all research (Graham, 2006) and has the potential to derail even the most promising study if not properly addressed. The presence of missing values in the current study occurred due to the fact that respondents were given a sixth option when responding to the PGLCQ, namely that of “cannot rate”. Clear instructions were given that this option was to be used sparingly; however, many respondents opted for this response category in situations where they felt they were not in a position to rate themselves on an item, or where a manager or supervisor felt they were not in a position to rate a specific graduate (leader) on an item.

While a number of options were available to circumvent the missing values problem, a decision was taken in Chapter 3 to utilise the multiple imputation technique for the present study if possible.<sup>285</sup> It was argued that multiple imputation was the preferred option for use as it has the advantage of retaining all the cases that were sampled, which many of the other imputation techniques (i.e. listwise or pairwise deletion of cases, or imputation by matching) do not. As the success of the present study was particularly sensitive to the number of cases sampled, the researcher was optimistic that the nature of the data collected would permit the use of the multiple imputation technique. In this regard, Mels (2003) argues that multiple imputation is an acceptable option for use as long as not more than 30% of a data set is missing, that the missing values on the questionnaire under consideration have an ignorable missing at random (MAR)<sup>286</sup> response mechanism, and that the available data values conform to a multivariate normality distribution or are at least not excessively skewed. For the present study, the distribution of missing values across items of the PGLCQ is shown in Table 5.19. Fortunately, only 442 (3.8%) of the 11700<sup>287</sup> data points were missing. The data, moreover, also did not appear to be *excessively* skewed. Appendix G indicates that only 14.44% of the item distributions were statistically significantly ( $p < .05$ ) skewed. Only 3.33% of the item distributions statistically significantly ( $p < .05$ ) deviated from a mesokurtic distribution. None of the item distributions were statistically significantly positively skewed. In all cases where the item distributions statistically significantly ( $p < .05$ ) deviated from a symmetric distribution the distributions were all negatively skewed. Only 2.22% of the item distributions were statistically significantly ( $p < .05$ ) leptokurtic and only 1.11% were statistically significantly platykurtic. The majority of the item distributions (96.67%) of the item distributions were mesokurtic.

Consequently, multiple imputation (via PRELIS) was conducted on the sample of 133 completed responses. The imputed data set was utilised for subsequent analyses. The items that had the most missing values were all part of the *develops unit competitiveness*<sup>288</sup> subscale. More specifically, Q62 had the most missing values with 27, followed by Q64 with 24, Q60 and Q66 with 17 each, and Q59 with 15. Q62 measured *market standing* (the extent to which the graduate’s contributions to the unit’s performance strategy contributes to the unit being positioned as one of the top of its kind in the field/industry), Q64 measured *economic performance* (the extent to which the graduate’s contributions lead to a performance strategy in the unit that is highly entrepreneurial and stimulates high levels of economic growth in the organisation and

---

<sup>285</sup> It is acknowledged that the decision to treat the response “cannot rate” as a missing value and to impute these values is to some degree controversial. Imputation of missing values that arise due to oversight or forgetfulness seem to be more legitimate than cases where the respondent explicitly indicated that they are unable to respond to an item. Case-wise or listwise deletion of cases where such responses occurred was, however, not a practical option in the current study, given the already small sample size.

<sup>286</sup> When missing values are missing at random (MAR) it means that the probability for a data point to be missing is not related to the variable on which missingness occurred, but it is related to some of the observed data.

<sup>287</sup>  $130 \times 90 = 11\,700$  data points.

<sup>288</sup> It would appear that respondents still had trouble rating this competency despite the fact that the sample was broadened to graduates at varying levels of leadership development across South Africa. Moreover this was the competency that was flagged in the qualitative part of the study as the least important of all of the relevant nine explicated second-order graduate leader competencies.

community), Q66 measured *market benchmark* (the extent to which the graduate's efforts lead to the unit's performance strategy being regarded as the ultimate benchmark of competitiveness/excellence in the market), Q60 measured *buy-in* (the extent to which the graduate's contribution to the unit's performance strategy leads to its widespread acceptance because the concerns of all of the relevant constituencies have been properly consulted), and Q59 measured *market niche* (the extent to which the graduate's contribution to the performance strategy of the unit/team makes the unit/team relevant and successful in the market over the long term).

It is inferred that participants were more prone to select the 'cannot rate' option for this subscale (Comp\_E; *develops unit competitiveness*) and the aforementioned items as the graduates being rated here did not have substantial opportunities to significantly affect the performance strategies of their units (or teams). This appeared to be true for "fresh" graduates in training as well as for more senior graduates at more sophisticated levels of leadership. As discussed in Chapter 2, this trend could be the result of the South African economy's continuing over-reliance on hierarchical, centralised (Jackson, 1999) and generally over-managed organisations (Hofmeyer, 1998) that still do not give employees and aspiring leaders the opportunities/scope and the necessary development to be able to meaningfully contribute to the (performance/business) strategies of their units (or teams).

Table 5.19

*Distribution of missing values across items of the PGLCQ*

Q13	Q14	Q15	Q16	Q17	Q18	Q19	Q20	Q21	Q22	Q24	Q25	Q26
0	1	2	4	1	5	8	1	1	2	10	5	3
Q27	Q28	Q29	Q30	Q31	Q32	Q33	Q35	Q36	Q37	Q38	Q39	Q40
2	2	2	3	4	1	5	4	2	9	5	4	4
Q41	Q42	Q43	Q44	Q46	Q47	Q48	Q49	Q50	Q51	Q52	Q53	Q54
4	6	5	5	0	1	2	0	2	0	1	2	0
Q55	Q57	Q58	Q59	Q60	Q61	Q62	Q63	Q64	Q65	Q66	Q68	Q69
1	20	9	15	17	5	27	4	24	5	17	3	3
Q70	Q71	Q72	Q73	Q74	Q75	Q76	Q77	Q79	Q80	Q81	Q82	Q83
8	3	1	8	3	4	1	3	5	1	2	6	5
Q84	Q85	Q86	Q87	Q88	Q90	Q91	Q92	Q93	Q94	Q95	Q96	Q97
3	8	4	2	5	4	3	1	7	3	3	5	5
Q98	Q99	Q101	Q102	Q103	Q104	Q105	Q106	Q107	Q108	Q109	Q110	
8	4	6	13	12	8	1	5	2	7	2	3	

## 5.5 ITEM AND DIMENSIONALITY ANALYSIS FOR THE PGLCQ

The PGLCQ aimed to evaluate graduate leaders' performance on the 9 (presumed) unidimensional second-order latent behavioural competencies of *displays personal leader proficiency, analyses and understands the external and internal work unit environment, creates an exciting and aspirational vision for the unit, develops unit competitiveness, entrenches a high-performance culture in the unit, involves others and elicits participation, unites and connects followers, strengthens and enables followers, and manages the internal work unit environment*. Each competency was measured via 10 items utilising five-point Likert scales with an additional *cannot rate* option.

It must be kept in mind that thematic analysis was employed in order to "conceive" these second-order competencies (latent constructs) by using the first-order competencies that were identified in the literature study in Chapter 2 as a point of reference. Second-order factors do not represent the totality of the first-order factors that load on them. Rather they represent the systematic source of variance shared by the first-order factors that cause them to correlate. Thus, these hypothetical higher-order constructs (i.e. second-order competencies) can be interpreted as 'labels' or umbrella terms for the shared content of all of the clusters or domains of (assumed) co-varying behaviours (i.e. the first-order competencies) that were deemed fit for inclusion in each



separate (second-order) construct. The fact that the researcher employed this methodology meant that there was a real danger that the second-order competencies could become *saturated* to a point where their content could become contaminated with too many conflicting strata. While the researcher did take some care (Patton, 1990) in attempting to ensure the *internal* (i.e. content within second-order competencies should cohere together meaningfully) and *external homogeneity* (i.e. there should be clear and identifiable distinctions between the latent constructs) of the second-order competencies that emerged from the thematic analysis, there was still no guarantee (other than on face value) that these aims were successfully achieved. A more definitive stance regarding the legitimacy of these latent constructs (i.e. the second-order graduate leader competencies), their hypothesised dimensionalities, and the extent that these were actually validly and reliably measured via the various developed subscales could only be taken if and once the PGLCQ subscales measuring these second-order competencies were able to withstand the scrutiny of intensive comprehensive item and dimensionality analyses first.

Accordingly, classic measurement theory item analysis was performed on each of the subscales (presumably) measuring a second-order competency, followed by dimensionality analysis on each subscale. More specifically, in terms of item analysis, the researcher screened the items of each subscale by way of the: a) corrected item-total correlations that appeared as distinct outliers to the lower end of the distribution of corrected item-total correlations; b) squared multiple correlations that appeared as distinct outliers to the lower end of the distribution of squared multiple correlations; c) extreme means or low standard deviations; d) items that consistently correlated lower than the mean inter-item correlation with the remaining items of the subscale; and e) a sufficient increase in the Cronbach alpha value when an item was to be deleted<sup>289</sup>. The purpose of this analysis was to evaluate how well each set of subscale questions, designed to elicit information about a specific second-order competency, was able to give consistent evidence on the extent to which graduates was rated (or rated themselves) in terms of their mastery of the competency under investigation. In Chapter 3 it was explained that a Cronbach alpha (internal) reliability coefficient would be calculated as part and parcel of the item analysis procedure but not used as a definitive benchmark for reporting the reliability features of each PGLCQ subscale. As Cronbach alpha assumes that a subscale is unidimensional,<sup>290</sup> satisfies the assumptions of essential tau equivalence,<sup>291</sup> that the data under investigation is multivariate normal in nature,<sup>292</sup> and that these assumptions might not (all) hold true with regards to the subscales investigated in the current study, the researcher decided not to use Cronbach alpha as a *definitive indicator* of reliability when reporting the item analysis results.<sup>293</sup> Instead, the researcher opted to report a more appropriate measure of reliability (McDonald omega, or Stratified alpha) only after the evaluation of subscale dimensionality was completed.

In addition to this above-mentioned purpose, dimensionality analysis was subsequently also necessary in order to evaluate the assumptions that: 1) the items assigned to each PGLCQ subscale measured a single underlying factor; and 2) to evaluate the success of each item in

---

<sup>289</sup> It is acknowledged that violations of the assumptions underlying Cronbach's alpha will also affect these statistics. Moreover, Raykov (1997a) warned that alpha estimates are sample specific and argued that any increase or decrease in alpha resulting from the deletion of an item is a consequence of the characteristics of the sample at hand and thus that it is dangerous to carry over the results to alternative samples. Secondly, Raykov (2001) warns that the population estimate of alpha can easily be overestimated or underestimated due to the deletion of an item.

<sup>290</sup> If the assumption of unidimensionality is violated, Sijtsma (2009) and Raykov (2001) have demonstrated that  $\alpha$  may be overestimated.

<sup>291</sup> If the assumption of tau-equivalence is violated, Raykov (1997b) and Graham (2006) suggest that  $\alpha$  may be underestimated.

<sup>292</sup> According to Sheng and Sheng (2012), a negative bias is produced in coefficient  $\alpha$  when data distributions are skewed and/or leptokurtic.

<sup>293</sup> This does not mean that the researcher did not use Cronbach Alpha as an additional, informal indicator of scale reliability during item analysis at all. The researcher felt that there was still value in consulting the "Cronbach's Alpha if deleted" output from SPSS in order to assist in making decisions regarding the suitability of retaining or removing certain subscale items that were regarded as potentially problematic.

measuring the specific latent variable (i.e. second-order graduate leader competency) it was meant to represent. In this sense dimensionality analyses likewise allowed the researcher the opportunity to identify and remove items that had inadequate factor loadings, but in addition, to split single heterogeneous subscales into two or more subscales if and where this was required. In Chapter 3 it was debated whether the evaluation of the unidimensionality of the PGLCQ subscales should proceed by way of exploratory factor analysis or confirmatory factor analysis. As a specific design intention guided the development of the PGLCQ subscales in which specific items were assigned to reflect graduate leaders' standing on specific latent competency dimensions, the researcher ultimately opted for the more theoretically correct approach of utilising a confirmatory factor analysis for evaluating the fit of single-factor measurement models. The unidimensionality assumption was supported if the close fit null hypothesis was not rejected ( $p > .05$ ) or if a model showed at least reasonable fit in the sample. Conversely, if the unidimensionality assumption was not supported, the researcher then only reverted to an exploratory factor analysis in order to further explore the underlying factor structure of the subscale in question. If a single factor was extracted in such a case, the solution was evaluated in terms of the proportion of variance explained by the factor, the percentage of non-redundant residuals with absolute values above .05, and the size of the factor loadings. Items with poor factor loadings were then considered for deletion. However, in the case of a single factor structure not providing a valid explanation for the observed inter-item correlation matrix, the extraction of an additional factor was requested. Furthermore, in a case where more than one factor was extracted, either via the default eigenvalue-greater-than-one rule or via the researcher's request, the factor pattern matrix was evaluated to determine the possible reasons for this solution. In a case where the additional factor(s) were clearly due to one or more poor items, the item(s) in question were considered for deletion and the process repeated in order to evaluate the new factor solution without the deleted item(s). However, if the factor loadings in the factor pattern matrix were suggestive of the possibility of a theoretically meaningful additional factor (or factors), and this conclusion could be theoretically supported, factor fission was considered. In such cases, the multiple factor solution was further evaluated and confirmed by means of confirmatory factor analysis. If the two (or more) factor measurement model achieved close fit this vindicated the conclusion of meaningful factor fission. A second-order measurement model<sup>294</sup> was then fitted to allow the calculation of the statistical significance of the indirect effect of the second-order factor on the items. If the indirect effect would be found to be statistically significant ( $p < .05$ ) this would warrant the use of the items as indicators of the higher-order factor. If, however, the two (or more) factor measurement model fitted poorly the possibility of a bifactor model was considered by studying the modification indices calculated for the off-diagonal of the measurement error variance-covariance matrix ( $\Theta_{\delta}$ ). If a large percentage of the modification index values would indicate that the model fit would statistically significantly ( $p < .01$ ) improve if the measurement error terms would be allowed to correlate, this would suggest that the model fails to acknowledge an additional source of systematic variance that affects most, if not all, the items. This in turn suggests a bifactor model that makes provision for a broad, general factor on which all items load and two (or more) narrow, more specific factors on which only specific factors load (Reise, 2012). The general factor is uncorrelated with the two narrow factors. If a bifactor model was suggested, and it showed close fit, the statistical significance of the loadings of the items on the broad, general factor and the specific, narrow (group) factors were examined and the  $R^2$  for the items were examined.

---

<sup>294</sup> It is acknowledged that the use of the term second-order factor could cause semantic confusion here in that the first-order factors are actually already second-order factors.

## 5.5.1 PSYCHOMETRIC EVALUATION OF THE 'DISPLAYS PERSONAL LEADER PROFICIENCY' SUBSCALE

### 5.5.1.1 Item analysis

The *displays personal leader proficiency* subscale intended to measure the extent to which the graduate leader functions as a well-rounded, sought after and high impact resource in the unit (team). The SPSS 26 output extracted for the item analysis of this subscale fortunately did not give rise to any significant concerns on the part of the researcher regarding the suitability of using its items for subsequent analyses. The output as presented under Table 5.20 indicates that the item means for this subscale ranged from 3.218 to 4.278 on a 5-point scale and that the item standard deviations ranged from .710 to 1.054. This indicated that respondents typically rated their performance (or the performance of their subordinate) on the *displays personal leader proficiency* competency as satisfactory and above the required standard and that respondents' ratings were relatively spread out around the item means. More importantly, none of the items revealed themselves as outliers to the bottom end of the item standard deviation distribution. The absence of extreme means and small standard deviations for each of the items suggested that they all were able to detect relatively small differences in the level of competence graduate leaders achieved on the *displays personal leader proficiency* competency. Put differently, the *displays personal leader proficiency* subscale did not appear to elicit grossly uniform and undiscerning responses and it was therefore deemed to be able to sufficiently discriminate between participant responses in measuring the latent construct underlying this subscale.

An investigation into the inter-item correlation matrix output also resulted in generally positive findings. Correlations between items in the subscale ranged from .089 to .592. On the suggestion of Guilford, (cited in Tredoux & Durheim, 2002) correlations between these items were interpreted as being low (.20 to .39; definite but small relationship), moderate (.40 to .69; substantial relationship) or high (.70 to .89; strong relationship). While all of the items in the matrix correlated quite favourably with each other on a consistent basis in this regard and therefore appeared to measure the same (but not necessarily a unidimensional) latent variable, the researcher still flagged items Q16 and Q18 as potentially problematic, because they were generally considered as the poorest correlates with the other items in the subscale. Item Q18 consistently correlated lower than the mean inter-item correlation with the remaining items of the subscale (.358). Item Q16 likewise consistently correlated lower than the mean inter-item correlation with the remaining items of the subscale (.358) but for its correlation with item Q17. Item Q22 showed itself somewhat less of a problematic item in the inter-item correlation matrix in that it consistently correlated lower than the mean inter-item correlation with the remaining items of the subscale (.358) but for its correlation with items Q15 and Q20. However, the extent of these correlations with the other items in the subscale was not sufficiently low in order to consider Q16, Q18 and Q22 for removal on these grounds alone. It simply indicated that Q16 and Q18 in particular were not in the same class as the other items (i.e. they probably measured a smaller bandwidth of the construct but not (necessarily) that they were measuring a different construct entirely.<sup>295</sup>

---

<sup>295</sup> In addition, if item O16 and Q22 were to have been deleted it would have made no difference to the Cronbach alpha (.843) of the subscale and if item Q 18 were to have been deleted it would have produced a marginal decline in the Cronbach alpha.

Table 5.20

*Item analysis output for the displays personal leader proficiency subscale*

Reliability Statistics	
Cronbach's Alpha	N of Items
.843	10

Item Statistics			
	Mean	Std. Deviation	N
Q13	4.27820	.710883	133
Q14	3.78947	1.000399	133
Q15	3.81203	.808575	133
Q16	3.21805	1.054129	133
Q17	3.90977	.811458	133
Q18	3.84962	.965278	133
Q19	3.60902	.860185	133
Q20	3.68421	.856069	133
Q21	3.68421	.856069	133
Q22	3.81955	.796152	133

Inter-Item Correlation Matrix										
	Q13	Q14	Q15	Q16	Q17	Q18	Q19	Q20	Q21	Q22
Q13	1.000	.445	.448	.222	.490	.326	.489	.320	.407	.089
Q14	.445	1.000	.428	.317	.406	.304	.520	.391	.514	.275
Q15	.448	.428	1.000	.244	.378	.323	.449	.592	.428	.359
Q16	.222	.317	.244	1.000	.360	.189	.345	.320	.262	.237
Q17	.490	.406	.378	.360	1.000	.292	.329	.384	.362	.268
Q18	.326	.304	.323	.189	.292	1.000	.348	.309	.355	.053
Q19	.489	.520	.449	.345	.329	.348	1.000	.510	.551	.283
Q20	.320	.391	.592	.320	.384	.309	.510	1.000	.535	.416
Q21	.407	.514	.428	.262	.362	.355	.551	.535	1.000	.216
Q22	.089	.275	.359	.237	.268	.053	.283	.416	.216	1.000

Item-Total Statistics					
	Scale Mean if Item Deleted	Scale Variance if Item Deleted	Corrected Item-Total Correlation	Squared Multiple Correlation	Cronbach's Alpha if Item Deleted
Q13	33.37594	27.327	.549	.436	.829
Q14	33.86466	24.785	.615	.416	.821
Q15	33.84211	26.134	.620	.461	.822
Q16	34.43609	26.308	.415	.212	.843
Q17	33.74436	26.616	.554	.375	.827
Q18	33.80451	26.840	.414	.215	.841
Q19	34.04511	25.437	.661	.490	.817
Q20	33.96992	25.575	.647	.517	.818
Q21	33.96992	25.757	.624	.457	.821
Q22	33.83459	28.200	.364	.258	.843

Summary Item Statistics							
	Mean	Minimum	Maximum	Range	Maximum /	Variance	N of Items
Item Means	3.765	3.218	4.278	1.060	1.329	.070	10
Item Variances	.770	.505	1.111	.606	2.199	.035	10
Inter-Item Correlations	.358	.053	.592	.539	11.143	.013	10

Finally, the researcher investigated the corrected item-total correlations and the squared multiple correlations SPSS output for the subscale. The corrected item total correlations indicates the correlations between each item and the total subscale score (without the respective item included in the scale composite). Item Q16 (.415), item Q18 (.414) and item Q22 (.364) showed themselves as potential outliers in the distribution of corrected item-total correlations. The squared multiple correlations output, in turn, indicate the squared correlation when regressing each item on a weighted linear composite of the remaining variables in the subscale. The squared multiple correlations for the *displays personal leader proficiency* subscale ranged from .212 to .490. Item Q16 (.212), item Q18 (.215) and item Q22 (.258) were again flagged as the weakest correlates and as potential outliers. These three items therefore were relatively more incomprehensible to their item colleagues. The three items could, however, not really be flagged as extreme red-card outliers. Although the remaining items found it relatively more difficult to

accurately predict the responses of these three items they were as yet not totally unable to do so, again suggesting that none of these three items clearly responded to an altogether different source of variance than the others in the *displays personal leader proficiency* subscale item set. Based on the basket of evidence collected therefore, none of the items were removed from the *displays personal leader proficiency* subscale.

### 5.5.1.2 Dimensionality analysis

The dimensionality analysis for all the PGLCQ subscales proceeded by way of a confirmatory factor analysis (CFA) via LISREL 8.8. However, before the CFAs could be conducted, the researcher first had to determine the proper estimation method to be used in each case. Accordingly, the distributional properties of the *displays personal leader proficiency subscale* were tested by way of PRELIS 2 (see Table 5.21 below).

Table 5.21

#### *PRELIS test of multivariate normality output for the displays personal leader proficiency subscale*

Skewness			Kurtosis			Skewness and Kurtosis	
Value	z-score	p-value	Value	z-score	p-value	Chi-Square	p-value
16.631	5.940	.000	130.230	3.570	.000	48.030	.000

As can be seen from the output presented under Table 5.21, the null hypothesis that the indicator variable distribution in the parameter for the *displays personal leader proficiency* subscale followed a multivariate normal distribution was rejected (due to a statistically significant skewness and kurtosis chi-squared statistic  $p < .05$ ). Consequently, the researcher opted for Robust Maximum Likelihood (RML) as an estimation technique<sup>296</sup> in order to analyse the dimensionality of this particular subscale. This decision was made as the RML in combination with Satorra and Bentler's extension provides a correctly scaled chi-square statistic that is more appropriate for use (than the default ML estimator) in situations where the assumption of a multivariate normal distribution does not hold. The first-order *displays personal leader proficiency* measurement model fitted via RML is shown in Figure 5.1.

<sup>296</sup> Note that the researcher did not try to normalise the data first, as the RML estimator already provides a scaled chi-square statistic and corrects for non-normality-induced bias in standard errors.

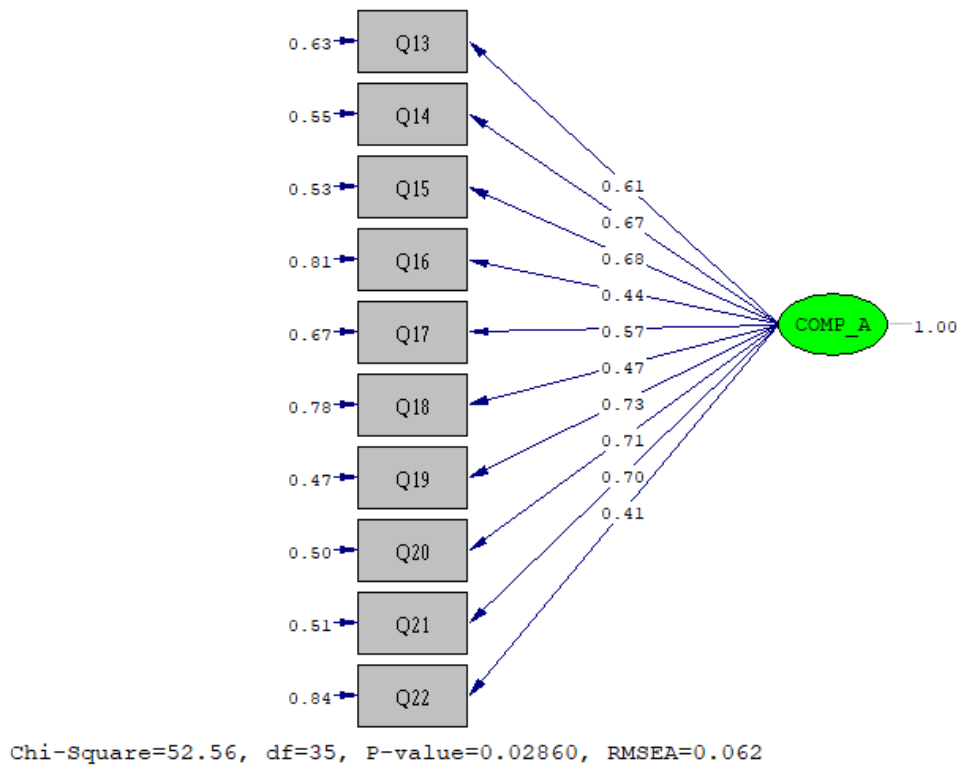

Figure 5.1. First-order displays personal leader proficiency measurement model (completely standardised solution)

The Satorra-Bentler scaled chi-squared statistic resulting from the analysis indicated that the exact fit null hypothesis for this subscale had to be rejected because the chi-square statistic delivered a statistically significant value ( $\chi^2 = 52.56$ ;  $p < .05$ ). However, the close fit null hypothesis (RMSEA = .062;<sup>297</sup>  $p > .05$ ) was not rejected<sup>298</sup>. In terms of large standardised variance-covariance residuals<sup>299</sup> ( $> 2.58$  or  $< -2.58$ ), the LISREL output indicated that the measurement model for the *displays personal leader proficiency* subscale only significantly ( $p < .01$ ) overestimated ( $\leq -2.58$ ) 2 values (-2.789 and -2.6) and significantly ( $p < .01$ ) underestimated ( $\geq 2.58$ ) 1 value (2.9) out of the 55 variances and covariances observed in the covariance matrix (5.5%). This finding commented favourably in terms of the fit of the *displays personal leader proficiency* measurement model. The unidimensionality assumption was thus satisfied for the *displays personal leader proficiency* subscale.

The close fit of the *displays personal leader proficiency* subscale warranted the interpretation of the statistical significance and magnitude of the measurement model parameter estimates. The unstandardised factor loading matrix ( $\Lambda^*$ ) is shown in Table 5.22.

<sup>297</sup> Hu and Bentler (1999) suggest a critical cut-off value close to 0.6 while Steiger (2007) suggests that an upper limit of 0.07 can still be considered as good (or reasonable fit).

<sup>298</sup> The full array of fit statistics produced by LISREL 8.8 is shown in Appendix H.

<sup>299</sup> The standardised variance-covariance residuals represent the difference between the corresponding cells in the observed variance-covariance matrix and the estimated or reproduced variance-covariance matrix divided by its estimated standard error (Byrne, 1998).

Table 5.22

*Unstandardised factor loading matrix ( $\Lambda^X$ ) for the displays personal leader proficiency measurement model*

Item	COMP_A
Q13	0.4342* (0.0725) 5.9918
Q14	0.6729* (0.0891) 7.5523
Q15	0.5518* (0.0749) 7.3656
Q16	0.4644* (0.0936) 4.9634
Q17	0.4665* (0.0665) 7.0165
Q18	0.4502* (0.1020) 4.4158
Q19	0.6266* (0.0605) 10.3527
Q20	0.6064* (0.0775) 7.8231
Q21	0.6012* (0.0747) 8.0468
Q22	0.3232* (0.0626) 5.1673

Note: the first row in each cell in column 2 of Table 5.22 represents the unstandardised factor loading estimate ( $\lambda_{ij}$ ), row two (in brackets) represents the standard error and the third row represents the unstandardised estimate transformed to a z-score obtained by dividing the unstandardised estimate by its standard error.

\*p < .05

Table 5.22 shows that all the items of the *displays personal leader proficiency* subscale loaded statistically significantly (p < .05) on the single latent competency. The claim that the item responses are positively linearly related to the standing on the latent competency can therefore be generalised to the population (i.e. there is less than a 5% chance that these factor loading findings occurred due to sampling error under  $H_{0i}: \lambda_{ijk} = 0$ ). The completely standardised<sup>300</sup> factor loadings are shown in Table 5.23.

Table 5.23

*Completely standardised factor loading matrix ( $\Lambda^X$ ) for the displays personal leader proficiency measurement model*

Item	COMP_A
Q13	.6108
Q14	.6726
Q15	.6825
Q16	.4405
Q17	.5749
Q18	.4664
Q19	.7284
Q20	.7084
Q21	.7023
Q22	.4060

<sup>300</sup> In the completely standardised solution both the item and the latent variable distributions have been transformed to have a mean of 0 and a standard deviation of 1.

Table 5.23 shows that the loading for three items (Q16, Q18 and Q22) fell below the critical cut-off value of .50. This dovetails with the results of the item analysis. The completely standardised factor loadings of these three items are, however, all still above .40 thus vindicating the decision not to delete these items despite their performance in the preceding item analysis.

In addition, the researcher also screened the unstandardised (Table 5.24) and standardised theta-delta matrices (Table 5.25) pertaining to the statistical significance and magnitude of the measurement error variances in the measurement model. Table 5.24 shows that all of the unstandardised measurement error variance estimates were found to be statistically significant ( $p < .05$ ) (i.e. all z scores surpassed the critical 1.6449 threshold), indicating the generalisability of these findings<sup>301</sup>. Table 5.25 indicates that the magnitude of the measurement error variances for all items ranged between .469 and .835, with the majority of the item values here gravitating around 0.5. The completely standardised measurement error variances across the majority of the indicators therefore fell in a reasonable (but not ideal) range, suggesting that between 47% to 62% of the variance in the majority of indicators was due to measurement error. The results in Table 5.25 again dovetail with the completely standardised factor loading results in Table 5.23 and the item analysis results in Table 5.20. More than 78% of the variance in items Q16, Q18 and Q22 is due to systematic and random (Diamantopoulos & Siguaw, 2001) measurement error.

Table 5.24

*Unstandardised measurement error variance matrix ( $\Theta_{\delta}$ ) for the displays personal leader proficiency measurement model*

Q13	Q14	Q15	Q16	Q17	Q18
0.3168*	0.5480*	0.3493*	0.8956*	0.4409*	0.7291*
(0.0435)	(0.1012)	(0.0483)	(0.1411)	(0.0595)	(0.0845)
7.2796	5.4156	7.2336	6.3468	7.4141	8.6300
Q19	Q20	Q21	Q22		
0.3473*	0.3651*	0.3714*	0.5294*		
(0.0513)	(0.0493)	(0.0753)	(0.0726)		
6.7678	7.4099	4.9299	7.2931		

Note: the first row in each cell in each column of Table 5.24 represents the unstandardised measurement error variance estimate ( $\theta_{\delta ii}$ ), row two (in brackets) represents the standard error and the third row represents the unstandardised estimate transformed to a z-score obtained by dividing the unstandardised estimate by its standard error.

\* $p < .05$

Table 5.25

*Completely standardised measurement error variance matrix ( $\Theta_{\delta}$ ) for the displays personal leader proficiency measurement model*

Q13	Q14	Q15	Q16	Q17	Q18
.6270	.5476	.5342	.8059	.6695	.7825
Q19	Q20	Q21	Q22		
.4694	.4982	.5068	.8352		

Furthermore, the  $R^2$  values obtained for the items in this subscale are presented in Table 5.26 below. The magnitudes of the factor loadings for each respective item indicated that except for Q16, Q18 and Q22, between 33% to 53% of the variance in the items could be explained by the overarching factor the subscale intended to reflect. In this regard, effect sizes were interpreted as small ( $r = 0.10$ ); medium ( $r = .30$ ); and large ( $r = .50$ ) (Cohen, 1992; 1988).

<sup>301</sup> Although measurement error is not desired it is nonetheless an inevitable feature of psychological measurement. Statistically insignificant ( $p > .05$ ) measurement error variance estimates would imply that the position that the items produce perfectly reliable measures in the parameter cannot be rejected. This creates mistrust in the subscale items because it represents an extremely implausible scenario that is simply too good to be true.



Table 5.26

*R<sup>2</sup> values for the displays personal leader proficiency measurement model*

Q13	Q14	Q15	Q16	Q17
.373	.452	.465	.194	.330
Q18	Q19	Q20	Q21	Q22
.217	.530	.501	.493	.164

Thus, although it was apparent that Q16, Q18 and Q22 were somewhat plagued by systematic and random error, in totality the basket of evidence collected (i.e. reasonable fit, low percentage of standardised residuals, statistically significant ( $p < .05$ ) and reasonably large factor loadings, statistically significant ( $p < .05$ ) but reasonably low measurement error variances, reasonable to strong  $R^2$ ) for the *displays personal leader proficiency* measurement model ultimately supported the claims of unidimensionality for this subscale.

Given this conclusion, the researcher utilised JASP<sup>302</sup> to calculate the McDonald's omega reliability coefficient<sup>303</sup> as the definitive indicator of reliability for this subscale. The JASP output revealed that a satisfactory ( $> .80$ ) McDonald's omega of .851 was obtained, implying that approximately 85.1% of the variance in the items included in the scale was because of true score variance, and only 14.9% was due to random error variance. As expected, given the results shown in Table 5.23, McDonald's omega ( $\omega = .851$ ) produced a slightly more favourable coefficient than was the case with Cronbach's alpha ( $\alpha = .843$ ) shown in Table 5.20.

## 5.5.2 PSYCHOMETRIC EVALUATION OF THE 'ANALYSES AND UNDERSTANDS THE EXTERNAL AND INTERNAL WORK UNIT ENVIRONMENT' SUBSCALE

### 5.5.2.1 Item analysis

The *analyses and understands the external and internal work unit environment* subscale intended to measure the extent to which the graduate leader systematically surveys and immerses themselves in the internal and external environment of the unit to collect and interpret information about critical occurrences or conditions on behalf of the unit as input to unit (or team) performance planning. Again, the results of the overall item analysis for this scale did not give rise to any significant concerns on the part of the researcher regarding the suitability of its use for subsequent analyses. As per Table 5.27, the item means for this subscale ranged from 3.323 to 3.864 on a 5-point scale, while the item standard deviations ranged from .824 to 1.104. More importantly, none of the items showed themselves as outliers in the item standard deviation distribution. On this subscale, the average respondent rated their performance on this competency at above the midpoint (i.e. 3.3 to 3.9), and therefore as satisfactory, and ratings were relatively spread out around the item means. The absence of extreme means and small standard deviations suggested that the items in the subscale did not elicit uniform, undifferentiating responses and was thus able to sufficiently discriminate between participant responses in measuring the latent construct underlying this scale.

The inter-item correlation matrix output indicated correlations between items ranging from .276 to .641. It was therefore concluded that the items in this subscale had small (but definite) to moderate and substantial relationships with each other, which was a favourable finding overall. Item Q29 was flagged here as this item had the lowest correlations with all of the other items in the subscale. Moreover, it consistently correlated lower than the mean inter-item correlation with the remaining items of the subscale. This item was therefore somewhat out of step with its item

<sup>302</sup> JASP is an open-source statistical software package that is supported by the University of Amsterdam.

<sup>303</sup> McDonald (1999) proposed the  $\omega_r$  coefficient for estimating reliability, which provides more realistic estimates of the true reliability of a scale in cases where the assumption of essential tau-equivalence does not hold.

colleagues. However, as the extent of this item's inter-correlations was not critically low and it was evident that by deleting this item that the Cronbach alpha coefficient of the scale would not increase in doing so, the item was retained in the subscale.

Table 5.27

*Item analysis output for the analyses and understands the external and internal work unit environment subscale*

Reliability Statistics	
Cronbach's Alpha	N of Items
.891	10

Item Statistics			
	Mean	Std. Deviation	N
Q24	3.32331	1.104734	133
Q25	3.39098	.911497	133
Q26	3.43609	1.061398	133
Q27	3.60902	.824204	133
Q28	3.49624	.858329	133
Q29	3.80451	.908367	133
Q30	3.56391	.847039	133
Q31	3.58647	.897200	133
Q32	3.86466	.927541	133
Q33	3.69925	.945363	133

Inter-Item Correlation Matrix										
	Q24	Q25	Q26	Q27	Q28	Q29	Q30	Q31	Q32	Q33
Q24	1.000	.588	.641	.556	.604	.313	.508	.465	.405	.406
Q25	.588	1.000	.598	.518	.418	.276	.497	.440	.332	.384
Q26	.641	.598	1.000	.603	.517	.333	.550	.597	.384	.479
Q27	.556	.518	.603	1.000	.501	.363	.481	.507	.346	.451
Q28	.604	.418	.517	.501	1.000	.407	.540	.436	.351	.465
Q29	.313	.276	.333	.363	.407	1.000	.410	.448	.409	.284
Q30	.508	.497	.550	.481	.540	.410	1.000	.548	.320	.450
Q31	.465	.440	.597	.507	.436	.448	.548	1.000	.324	.442
Q32	.405	.332	.384	.346	.351	.409	.320	.324	1.000	.463
Q33	.406	.384	.479	.451	.465	.284	.450	.442	.463	1.00

Item-Total Statistics					
	Scale Mean if Item Deleted	Scale Variance if Item Deleted	Corrected Item-Total Correlation	Squared Multiple Correlation	Cronbach's Alpha if Item Deleted
Q24	32.45113	33.719	.703	.574	.876
Q25	32.38346	36.193	.633	.463	.881
Q26	32.33835	33.695	.742	.602	.872
Q27	32.16541	36.533	.678	.478	.878
Q28	32.27820	36.369	.662	.493	.879
Q29	31.96992	37.696	.488	.333	.890
Q30	32.21053	36.395	.670	.479	.878
Q31	32.18797	36.108	.654	.482	.879
Q32	31.90977	37.325	.510	.335	.889
Q33	32.07519	36.373	.587	.399	.884

Summary Item Statistics							
	Mean	Minimum	Maximum	Range	Maximum /	Variance	N of Items
Item Means	3.577	3.323	3.865	.541	1.163	.031	10
Item Variances	.870	.679	1.220	.541	1.797	.030	10
Inter-Item Correlations	.452	.276	.641	.365	2.323	.009	10

Finally, an inspection of the corrected item-total correlations revealed that no extreme outliers were evident towards the lower end of the corrected item-total correlation distribution. Item Q29 returned the lowest corrected item-total correlation but was not sufficiently lower than those of the remaining items to convincingly tag it as an outlier. This suggested that the opinions of the individual items comprising the *analyses and understands the external and internal work unit environment* subscale regarding the competence of graduate leaders generally agreed with the combined opinion of the remaining items of the subscale save for item Q29. Finally, the squared

multiple correlations of all the items also achieved an acceptable threshold (the lowest was Q 29 at .333 and the highest Q26 at .602). Q29 (.333) was again flagged as the weakest correlate in this regard. Item Q29 again did not convincingly show itself as an outlier in the squared multiple correlation distribution. Item Q29 did not distinctly separate itself from the remaining  $R^2$  values at the extreme lower end of the squared multiple correlation distribution. In general, therefore, the items of the subscale, when combining their opinions in a weighted linear composite, were able to reasonably accurately anticipate the response of individual colleagues. The items of the subscale, when combining their opinions in a weighted linear composite, found the responses of item Q29 the least easy to predict. The inter-item correlations, the corrected item-total correlation for item Q29 and the squared multiple correlation of the item all suggest that item Q29 reflected the intended *analyses and understands the external and internal work unit environment* latent graduate leader competency to a lesser degree than the other items but not sufficiently so to seriously consider its deletion. In totality, therefore, and based on the basket of evidence collected, none of the items were removed from the *analyses and understands the external and internal work unit environment* subscale.

### 5.5.2.2 Dimensionality analysis

The dimensionality analysis for this subscale again proceeded by way of an investigation into its distributional properties (see Table 5.28 below). As can be seen from the PRELIS output presented in Table 5.28, the null hypothesis that the indicator variable distribution in the parameter for the *analyses and understands the external and internal work unit environment* subscale follows a multivariate normal distribution, was rejected (due to a statistically significant skewness and kurtosis chi-squared statistic  $p < .05$ ).

Table 5.28

*PRELIS test of multivariate normality output for the analyses and understands the external and internal work unit environment subscale*

Skewness			Kurtosis			Skewness and Kurtosis	
Value	z-score	p-value	Value	z-score	p-value	Chi-Square	p-value
12.577	2.616	.009	123.373	1.786	.074	10.033	.007

Consequently, the researcher opted for Robust Maximum Likelihood (RML) as an estimation technique in order to analyse the dimensionality of this particular subscale as well. The first-order *analyses and understands the external and internal work unit environment* measurement model fitted via RML is shown in Figure 5.2 below.

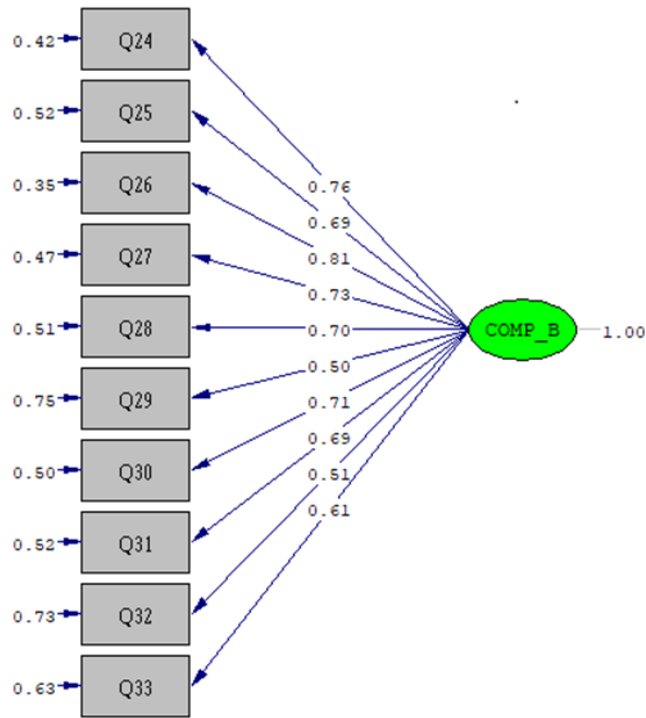

Chi-Square=46.66, df=35, P-value=0.09000, RMSEA=0.050

Figure 5.2. First-order analyses and understands the external and internal work unit environment measurement model (completely standardised solution)

The close fit of the *analyses and understands the external and internal work unit environment* subscale warranted the interpretation of the statistical significance and magnitude of the measurement model parameter estimates. The unstandardised factor loading matrix ( $\Lambda^x$ ) is shown in Table 5.29.

Table 5.29

*Unstandardised factor loading matrix ( $\Lambda^x$ ) for the analyses and understands the external and internal work unit environment measurement model*

Item	COMP_B
Q24	0.8445* (0.0815) 10.3593
Q25	0.6296* (0.0683) 9.2232
Q26	0.8560* (0.0628) 13.6319
Q27	0.5984* (0.0561) 10.6626
Q28	0.5994* (0.0747) 8.0221
Q29	0.4538* (0.0855) 5.3053
Q30	0.6009* (0.0696) 8.6282

Table 5.29

*Unstandardised factor loading matrix ( $\Lambda^x$ ) for the analyses and understands the external and internal work unit environment measurement model (continued)*

Item	COMP_B
Q31	0.6217* (0.0591) 10.5195
Q32	0.4776* (0.0940) 5.0796
Q33	0.5783* (0.0703) 8.2269

Note: the first row in each cell in column 2 of Table 5.29 represents the unstandardized factor loading estimate, row two (in brackets) represents the standard error and the third row represents the unstandardised estimate transformed to a z-score obtained by dividing the unstandardised estimate by its standard error

\*p <.05

Table 5.29 shows that all the items of the *analyses and understands the external and internal work unit environment* subscale loaded statistically significantly on the single latent competency. The null hypotheses that the parametric factor loadings are zero could therefore be rejected (i.e. there is less than a 5% chance that these factor loadings findings occurred due to sampling error under  $H_{0i}: \lambda_{jk} = 0$ ). The sample point estimates of the slope of the regression of the items on the latent competency could therefore be generalised to the population.

The completely standardised factor loading matrix ( $\Lambda^x$ ) for the *analyses and understands the external and internal work unit environment* subscale is shown in Table 5.30.

Table 5.30

*Completely standardised factor loading matrix ( $\Lambda^x$ ) for the analyses and understands the external and internal work unit environment measurement model*

Item	COMP_B
Q24	.7644
Q25	.6907
Q26	.8065
Q27	.7260
Q28	.6983
Q29	.4995
Q30	.7095
Q31	.6930
Q32	.5149
Q33	.6117

Table 5.30 indicates that only item Q29 fell below the critical cut-off value of .50, but then only by a whisker.

The unstandardised measurement error variance matrix for the *analyses and understands the external and internal work unit environment* subscale is shown in Table 5.31 and the completely standardised measurement error variance matrix in Table 5.32.

Table 5.31

*Unstandardised measurement error variance matrix ( $\Theta_{\delta}$ ) for the analyses and understands the external and internal work unit environment measurement model*

Q24	Q25	Q26	Q27	Q28	Q29
0.5073*	0.4344*	0.3938*	0.3212*	0.3775*	0.6192*
(0.0924)	(0.0567)	(0.0594)	(0.0458)	(0.0525)	(0.0683)
5.4927	7.6607	6.6260	7.0078	7.1888	9.0652
Q30	Q31	Q32	Q33		
0.3564*	0.4184*	0.6322*	0.5593*		
(0.0515)	(0.0516)	(0.0701)	(0.0661)		
6.9145	8.1034	9.0204	8.4553		

Note: the first row in each cell in each column of Table 5.31 represents the unstandardised measurement error variance estimate ( $\theta_{\delta ii}$ ), row two (in brackets) represents the standard error and the third row represents the unstandardised estimate transformed to a z-score obtained by dividing the unstandardised estimate by its standard error.

\*p < .05

Table 5.32

*Completely standardised measurement error variance matrix ( $\Theta_{\delta}$ ) for the analyses and understands the external and internal work unit environment measurement model*

Q24	Q25	Q26	Q27	Q28	Q29
.4156	.5229	.3496	.4729	.5123	.7505
Q30	Q31	Q32	Q33		
.4967	.5198	.7349	.6258		

An inspection of the unstandardised measurement error variance (Table 5.31) shows that the measurement error variances were all found to be statistically significant ( $p < .05$ ) (i.e. all z scores surpassed the critical 1.6449 threshold). The completely standardised theta-delta matrix for the *analyses and understands the external and internal work unit environment* measurement model revealed that only in the case of item Q29 was more than 75% of the item variance due to measurement error even if only marginally so.<sup>304</sup> This echoes the results of the item analysis and the findings on the completely standardised factor loadings for this subscale. The magnitude of the measurement error variances for all items ranged between .349 and .522 (except for Q33 with a value of .625, Q32 with a value of .734, and Q29 with a value of .750). However, for the majority of items in the subscale, the magnitudes of the measurement error variances gravitated around or below 0.5.

Furthermore, the  $R^2$  values obtained for the items in this subscale are presented in Table 5.33 below. Item Q29 revealed itself as the only item in which the latent competency it was earmarked to reflect, accounted for less than 25% of the item variance. The magnitudes of the squared completely standardised factor loadings of each respective item ranged between .477 and .650 (except for Q29 with a value of .249, Q32 with a value of .265, and Q33 with .374). This finding suggested that for the majority of the subscale, between 48% and 65% of the variance in each item could be explained by the overarching factor that the subscale intended to reflect.

Table 5.33

*$R^2$  values for the analyses and understands the external and internal work unit environment measurement model*

Q24	Q25	Q26	Q27	Q28
.584	.477	.650	.527	.487
Q29	Q30	Q31	Q32	Q33
.249	.503	.480	.265	.374

<sup>304</sup> Given that .50 had been set as the critical cut-off for the interpretation of the completely standardised factor loadings and given that  $\lambda_{ij} + \theta_{\delta ii} = 1$ , it follows that the critical cut-off for  $\theta_{\delta ii}$  is (a rather lenient) .75.

Despite the fact that Q29, Q32 and Q33 were somewhat plagued by systematic and random error, in totality the evidence collected (i.e. exact fit, statistically significant factor loadings, generally reasonably large completely standardised factor loadings, low percentage of residuals, reasonably low measurement error, moderate to strong  $R^2$  values) ultimately swayed the researcher's decision towards supporting the claim that the items of the *analyses and understands the external and internal work unit environment subscale* generally succeeded in providing psychometrically adequate measures of the unidimensional graduate leader competency.

Given this conclusion, the researcher utilised JASP to calculate McDonald's omega reliability coefficient for this subscale as well. The JASP output revealed that a satisfactory ( $> .80$ ) McDonald's omega of .895 was obtained, implying that approximately 89.5% of the variance in the items included in the scale was true score variance and only 10.5% was random error variance. Once again, McDonald's omega ( $\omega = .895$ ) produced a marginally more favourable estimate than was the case with Cronbach alpha ( $\alpha = .891$ ) for this subscale shown in Table 5.27.

### 5.5.3 PSYCHOMETRIC EVALUATION OF THE 'CREATES AN EXCITING AND ASPIRATIONAL VISION FOR THE UNIT' SUBSCALE

#### 5.5.3.1 Item analysis

The *creates an exciting and aspirational vision for the unit* subscale intended to measure the extent to which a graduate leader attracts and rallies a wide follower base towards an inspiring and exciting future vision of what can be achieved and how their lives can be fulfilled and become more meaningful by joining and investing in such a cause. The results of the item analysis for this subscale proved to be extremely favourable. Inspection of the item statistics SPSS output as per Table 5.34 revealed that the item means for this subscale ranged from 3.248 to 3.563 on a 5-point scale, and that the item standard deviations ranged from .810 to 1.040. No item showed itself as an outlier in the item standard deviation distribution. This indicated that the average respondent rated their performance (or that of their subordinate) at above the midpoint (i.e. 3.2 to 3.6), and therefore as satisfactory, and that all ratings were relatively spread out around the item means. All evidence therefore again pointed to the fact that the subscale did not elicit uniform, undifferentiating responses and that the subscale was able to sufficiently discriminate between participant responses in measuring the latent construct underlying the subscale.

Table 5.34

*Item analysis output for the creates an exciting and aspirational vision for the unit subscale*

Reliability Statistics	
Cronbach's Alpha	N of Items
.920	10

Item Statistics			
	Mean	Std. Deviation	N
Q35	3.44361	.940773	133
Q36	3.44361	.865269	133
Q37	3.35338	.914492	133
Q38	3.51128	.867044	133
Q39	3.24812	.810967	133
Q40	3.28571	.857864	133
Q41	3.39098	.860185	133
Q42	3.24812	1.040149	133
Q43	3.54135	1.026256	133
Q44	3.56391	.873459	133

Inter-Item Correlation Matrix										
	Q35	Q36	Q37	Q38	Q39	Q40	Q41	Q42	Q43	Q44
Q35	1.000	.641	.556	.537	.540	.518	.439	.529	.605	.560
Q36	.641	1.000	.585	.544	.533	.583	.427	.449	.444	.468
Q37	.556	.585	1.000	.611	.596	.575	.449	.576	.634	.593
Q38	.537	.544	.611	1.000	.540	.515	.482	.421	.572	.577
Q39	.540	.533	.596	.540	1.000	.551	.479	.519	.520	.507

Table 5.34

*Item analysis output for the creates an exciting and aspirational vision for the unit subscale (continued)*

	Q35	Q36	Q37	Q38	Q39	Q40	Q41	Q42	Q43	Q44
Q40	.518	.583	.575	.515	.551	1.000	.494	.599	.529	.552
Q41	.439	.427	.449	.482	.479	.494	1.000	.602	.531	.501
Q42	.529	.449	.576	.421	.519	.599	.602	1.000	.476	.529
Q43	.605	.444	.634	.572	.520	.529	.531	.476	1.000	.654
Q44	.560	.468	.593	.577	.507	.552	.501	.529	.654	1.000

Item-Total Statistics					
	Scale Mean if Item Deleted	Scale Variance if Item Deleted	Corrected Item-Total Correlation	Squared Multiple Correlation	Cronbach's Alpha if Item Deleted
Q35	30.58647	38.623	.716	.578	.910
Q36	30.58647	39.790	.672	.558	.913
Q37	30.67669	38.463	.756	.615	.908
Q38	30.51880	39.570	.693	.520	.912
Q39	30.78195	40.111	.692	.489	.912
Q40	30.74436	39.449	.714	.540	.911
Q41	30.63910	40.202	.636	.479	.915
Q42	30.78195	38.096	.678	.562	.913
Q43	30.48872	37.737	.721	.602	.910
Q44	30.46617	39.236	.720	.550	.910

Summary Item Statistics							
	Mean	Minimum	Maximum	Range	Maximum /	Variance	N of Items
Item Means	3.403	3.248	3.564	.316	1.097	.014	10
Item Variances	.825	.658	1.082	.424	1.645	.020	10
Inter-Item Correlations	.536	.421	.654	.233	1.553	.003	10

Table 5.34 further indicates that inter-item correlations for the subscale ranged between .421 and .654, demonstrating that all of the items in the subscale had moderate, substantial relationships with each other, which was an extremely pleasing and positive finding. None of the items showed themselves as outliers in the inter-item correlation distributions. None of the items therefore responded to a different source of systematic variance than its item colleagues in the subscale. The corrected item-total correlations were all moderately high ranging between .636 and .721. In addition, the squared multiple correlations for all items was found to be in satisfactory ranges (between .479 and .615), with both sets of statistics evidencing no extreme outliers towards the bottom of either of these distributions. From the SPSS output, it was moreover evident that the elimination of any one of the items would not improve the Cronbach alpha coefficient of the subscale (.920). Given the gravity of these findings in favour of a positive outcome for this item analysis, the researcher did not remove any of the items and continued with the dimensionality analysis for this scale "as is".

### 5.5.3.2 Dimensionality analysis

As was the case with the previous subscales, the dimensionality analysis for the *creates and exciting and aspirational vision for the unit* subscale also proceeded by way of an investigation into its distributional properties (see Table 5.35 below) via PRELIS.

Table 5.35

*PRELIS test of multivariate normality output for the creates an exciting and aspirational vision for the unit subscale*

Skewness			Kurtosis			Skewness and Kurtosis	
Value	z-score	p-value	Value	z-score	p-value	Chi-Square	p-value
21.117	9.036	.009	143.486	6.060	.000	118.383	.000



According to Table 5.35, it was again clear that the null hypothesis that the indicator variable distribution in the parameter follows a multivariate normal distribution had to be rejected (due to a statistically significant skewness and kurtosis chi-squared statistic;  $p < .05$ ). Hence, the first-order *creates an exciting and aspirational vision for the unit* measurement model was also fitted via RML as is shown in Figure 5.3 below.

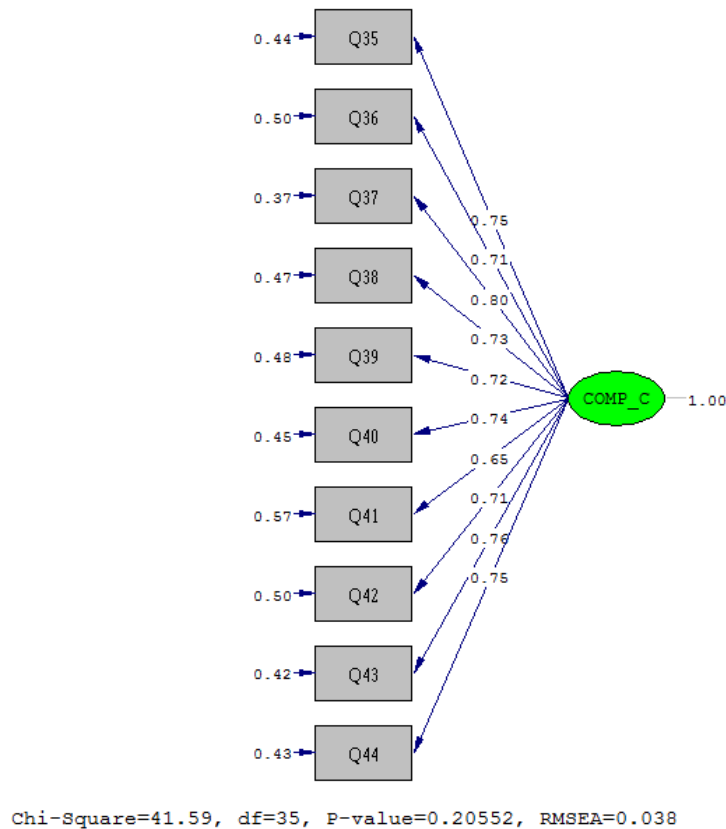

Figure 5.3. First-order *creates an exciting and aspirational vision for the unit* measurement model (completely standardised solution)

As was the case with the *analyses and understands the external and internal work unit environment* subscale, the first-order *creates an exciting and aspirational vision for the unit* measurement model obtained excellent fit in the parameter. This conclusion was made as the Satorra-Bentler chi-square statistic delivered a statistically insignificant value ( $\chi^2 = 41.59$ ;  $p > .05$ ), meaning that the exact fit null hypothesis did not need to be rejected. It therefore follows that the close fit null hypothesis (RMSEA = .038;  $p > .05$ ) could also not be rejected.<sup>305</sup> In terms of standardised residuals, the *creates an exciting and aspirational vision for the unit* measurement model significantly ( $p < .01$ ) overestimated only one covariance (-3.4836) out of the 55 variances and covariances observed in the covariance matrix (circa 2% in total). This finding thus commented extremely favourably in terms of the fit of the *creates an exciting and aspirational vision for the unit* measurement model.

The good fit of the *creates an exciting and aspirational vision for the unit* measurement model corroborates the unidimensionality assumption for this subscale. It moreover, warrants the

<sup>305</sup> The full array of fit statistics produced by LISREL 8.8 is shown in Appendix H.

interpretation of the statistical significance and magnitude of the measurement model parameter estimates. The unstandardised factor loading matrix ( $\Lambda^x$ ) is shown in Table 5.36.

Table 5.36

*Unstandardised factor loading matrix ( $\Lambda^x$ ) for the creates an exciting and aspirational vision for the unit measurement model*

Item	COMP_C
Q35	0.7033* (0.0633) 11.1139
Q36	0.6131* (0.0650) 9.4359
Q37	0.7271* (0.0646) 11.2635
Q38	0.6338* (0.0654) 9.6910
Q39	0.5873* (0.0688) 8.5348
Q40	0.6367* (0.0674) 9.4466
Q41	0.5633* (0.0772) 7.2964
Q42	0.7336* (0.0771) 9.5151
Q43	0.7808* (0.0696) 11.2202
Q44	0.6587* (0.0666) 9.8899

Note: the first row in each cell in column 2 of Table 5.36 represents the unstandardised factor loading estimate ( $\lambda_{ij}$ ), row two (in brackets) represents the standard error and the third row represents the unstandardised estimate transformed to a z-score obtained by dividing the unstandardised estimate by its standard error.

\*p < .05

Table 5.36 indicates that all the *creates an exciting and aspirational vision for the unit* subscale items statistically significantly ( $p < .05$ ) load on the single latent graduate leader competency. There was therefore less than a 5% chance that these factor loading findings occurred due to sampling error under  $H_{0i}$ :  $\lambda_{jk} = 0$ . The factor loading estimates shown in Table 5.36 may therefore be regarded as unstandardised point estimates of the parametric slopes of the regression of the subscale items on the latent graduate leader competency. The completely standardised factor loading matrix ( $\Lambda^x$ ) for the *creates an exciting and aspirational vision for the unit* subscale is shown in Table 5.37.

Table 5.37

*Completely standardised factor loading matrix ( $\Lambda^x$ ) for the creates an exciting and aspirational vision for the unit measurement model*

Item	COMP_C
Q35	.7475
Q36	.7086
Q37	.7951
Q38	.7310
Q39	.7242
Q40	.7422
Q41	.6549
Q42	.7053
Q43	.7609
Q44	.7542

Table 5.37 paints an extremely gratifying picture. All the completely standardised factor loadings of the *creates an exciting and aspirational vision for the unit* subscale exceed the critical cut-off value of .50. Nine out of ten items returned a completely standardised loading exceeding .70 with only item Q41 returning a completely standardised loading of .66. Given that the completely standardised factor loadings can be interpreted as correlation coefficients when each item only reflects a single latent variable, the majority of items in the *creates an exciting and aspirational vision for the unit* subscale can be interpreted as high (.70 to .89; strong relationship) in terms of Guilford's proposed taxonomy (cited in Tredoux & Durheim, 2002).

The unstandardised measurement error variance matrix for the *creates an exciting and aspirational vision for the unit* subscale is shown in Table 5.38 and the completely standardised measurement error variance matrix in Table 5.39.

Table 5.38

*Unstandardised measurement error variance matrix ( $\Theta_{\delta}$ ) for the creates an exciting and aspirational vision for the unit measurement model*

Q35	Q36	Q37	Q38	Q39	Q40
0.3905*	0.3728*	0.3076*	0.3500*	0.3127*	0.3306*
(0.0460)	(0.0478)	(0.0365)	(0.0451)	(0.0701)	(0.0543)
8.4873	7.8036	8.4193	7.7538	4.4595	6.0885
Q41	Q42	Q43*	Q44		
0.4226*	0.5437*	0.4435	0.3290*		
(0.0814)	(0.1009)	(0.0660)	(0.0454)		
5.1904	5.3871	6.7210	7.2544		

Note: the first row in each cell in each column of Table 5.38 represents the unstandardised measurement error variance estimate ( $\theta_{\delta ii}$ ), row two (in brackets) represents the standard error and the third row represents the unstandardised estimate transformed to a z-score obtained by dividing the unstandardised estimate by its standard error.

\*p < .05

Table 5.39

*Completely standardised measurement error variance matrix ( $\Theta_{\delta}$ ) for the creates an exciting and aspirational vision for the unit measurement model*

Q35	Q36	Q37	Q38	Q39	Q40
.4412	.4979	.3679	.4656	.4755	.4492
Q41	Q42	Q43	Q44		
.5711	.5025	.4211	.4312		

An inspection of the unstandardised error variance matrix (Table 5.38) indicates that the measurement error variances for the *creates an exciting and aspirational vision for the unit* subscale were found to be statistically significant ( $p < .05$ ) (i.e. all z scores surpassed the critical 1.6449 threshold). The completely standardised theta-delta matrix for this measurement model (Table 5.39), in turn, revealed measurement error variances for all items that ranged between .368 and .571. All the completely standardised error variances therefore fell below the critical cut-off value of .75 implied by the critical cut-off value set for the completely standardised factor loadings. Most values here, however, gravitated around the .40 mark. It was therefore concluded that measurement error accounted for less than (reasonable) 50% of the variance in the majority of the subscale's items.

Furthermore, the  $R^2$  values obtained for the items in this subscale are presented in Table 5.40 below. The magnitudes of the factor loadings of each respective item ranged between .498 and .632 (except for item Q41 with a value of .429). This finding indicated that for the majority of subscale items, circa 50% of the variance in each item could be explained by the overarching factor that the subscale intended to reflect.

Table 5.40

*R<sup>2</sup> values for the creates and exciting and aspirational vision for the unit measurement model*

Q35	Q36	Q37	Q38	Q39	Q40
.5588	.5021	.6321	.5344	.5245	.5508
Q41	Q42	Q43	Q44		
.4289	.4975	.5789	.5688		

Given the fact that the measurement model achieved reasonable fit in the parameter, that only 2% of the variances and covariances from the observed covariance matrix were overestimated, that at the most 57% of the variance in each of the subscale's items was due to measurement error, and that between 43% and 63% of the variance in each item could be explained by the overarching factor that the subscale was meant to reflect, the researcher concluded that the evidence collected supported the claim that the items of this subscale generally successfully reflected the *creates an exciting and aspirational vision for the unit* graduate leader competency.

Consequently, the researcher again opted to report the more theoretically correct McDonald omega reliability coefficient as the definitive indicator of reliability for this subscale. This time around, McDonald's omega ( $\omega = .921$ ) was only slightly larger than Cronbach alpha ( $\alpha = .920$ )<sup>306</sup>. Nonetheless, this implied that approximately 92.1% of the variance in the items included in the subscale was true score variance and only 7.9% was due to random error, which pointed to an excellent level of subscale reliability.

#### 5.5.4 PSYCHOMETRIC EVALUATION OF THE 'ENTRENCHES A HIGH-PERFORMANCE CULTURE IN THE UNIT' SUBSCALE

##### 5.5.4.1 Item analysis

The *entrenches a high-performance culture in the unit* subscale intended to measure the extent to which a graduate leader consistently behaves and makes decisions in a manner that serves the human condition by eliciting positively valenced psychological functioning in followers. While the results of the item analysis for this subscale was not as favourable as was the case with the *creates an exciting and aspirational vision for the unit* subscale, an evaluation of this scale nonetheless led the researcher to conclude that the all the items of this subscale psychometrically behaved in a manner consistent with the design intention that they all should reflect the *entrenches a high-performance culture in the unit* graduate leader competency. All items in the subscale could therefore be used 'as is' for subsequent analyses. Inspection of the item statistics SPSS output as per Table 5.41 revealed that the item means for this subscale ranged from 3.729 to 4.330 on a 5-point scale, and that the item standard deviations ranged from .756 to .886. On this subscale, participants typically rated their performance (or that of their subordinate) as above the required standard towards the top quartile of the scale (i.e. 4 out of 5) while all of their ratings were again relatively spread out around the item means. While the average response to this subscale was therefore higher than the subscales previously investigated, the items of this subscale did not appear to elicit uniform, undifferentiating responses, and it was concluded that the subscale was able to sufficiently discriminate between participant responses in measuring the latent construct underlying the subscale.

<sup>306</sup> It is evident from the factor loadings shown in Table 5.37 that the essential tau equivalence assumption made by Cronbach's alpha was only slightly violated in the sample.

Table 5.41

*Item analysis output for the entrenches a high-performance culture in the unit subscale*

Reliability Statistics	
Cronbach's Alpha	N of Items
.883	10

Item Statistics			
	Mean	Std. Deviation	N
Q46	4.33083	.756004	133
Q47	3.73684	.886727	133
Q48	3.65414	.853204	133
Q49	3.90226	.805894	133
Q50	3.77444	.774758	133
Q51	3.86466	.868488	133
Q52	3.90226	.833618	133
Q53	3.72932	.862764	133
Q54	4.16541	.780253	133
Q55	4.00000	.852803	133

Inter-Item Correlation Matrix										
	Q46	Q47	Q48	Q49	Q50	Q51	Q52	Q53	Q54	Q55
Q46	1.000	.492	.496	.514	.335	.380	.521	.382	.318	.282
Q47	.492	1.000	.480	.504	.431	.435	.529	.550	.403	.341
Q48	.496	.480	1.000	.446	.431	.396	.410	.541	.314	.344
Q49	.514	.504	.446	1.000	.462	.587	.459	.408	.375	.353
Q50	.335	.431	.431	.462	1.000	.562	.493	.429	.338	.355
Q51	.380	.435	.396	.587	.562	1.000	.473	.426	.413	.307
Q52	.521	.529	.410	.459	.493	.473	1.000	.563	.514	.394
Q53	.382	.550	.541	.408	.429	.426	.563	1.000	.506	.391
Q54	.318	.403	.314	.375	.338	.413	.514	.506	1.000	.319
Q55	.282	.341	.344	.353	.355	.307	.394	.391	.319	1.000

Item-Total Statistics					
	Scale Mean if Item Deleted	Scale Variance if Item Deleted	Corrected Item-Total Correlation	Squared Multiple Correlation	Cronbach's Alpha if Item Deleted
Q46	34.72932	28.214	.587	.435	.874
Q47	35.32331	26.645	.663	.462	.868
Q48	35.40602	27.334	.609	.435	.872
Q49	35.15789	27.346	.653	.488	.869
Q50	35.28571	27.918	.608	.427	.873
Q51	35.19549	27.068	.628	.481	.871
Q52	35.15789	26.801	.695	.528	.866
Q53	35.33083	26.769	.670	.514	.868
Q54	34.89474	28.322	.550	.360	.876
Q55	35.06015	28.421	.478	.242	.882

Summary Item Statistics							
	Mean	Minimum	Maximum	Range	Maximum /	Variance	N of Items
Item Means	3.906	3.654	4.331	.677	1.185	.044	10
Item Variances	.687	.572	.786	.215	1.376	.005	10
Inter-Item Correlations	.431	.282	.587	.305	2.082	.006	10

Inspection of the inter-item correlation matrix revealed that all of the items correlated quite favourably with each other on a consistent basis and therefore appeared to measure the same (but not necessarily unidimensional) latent construct. However, the researcher still flagged items Q54 and Q55 as potentially problematic, because they were the poorest correlates with the other items in the subscale. Item Q55 consistently correlated lower than the mean inter-item correlation (.431) with the remaining items of the subscale. However, as the "Cronbach alpha if deleted" column suggested that the overall scale reliability (.883) would not increase if any one of these items were deleted, and the level of inter-correlations that these items had with the other items in the matrix was not regarded as critically low (values ranged between .314 and .515 for Q54 and between .282 and .394 for Q55), the researcher did not regard this as sufficient grounds for seriously contemplating the removal of these items from the subscale.

Finally, the results of the corrected item-total correlations and the squared correlations for this subscale also did not raise any serious concerns. The corrected item-total correlations ranged from .478 to .670. No outliers were evident towards the bottom end of this distribution. The squared multiple correlations for all the items ranged between .360 and .528 (except for Q55 at .242) and no outliers were evident towards the bottom end of this distribution as well. Based on this basket of evidence, the researcher did not find any compelling reasons for justifying the removal any of the items of this subscale.

#### 5.5.4.2 Dimensionality analysis

The PRELIS output used for analysing the distributional properties of the *entrenches a high-performance culture in the unit* subscale is presented in Table 5.42 below.

Table 5.42

*PRELIS test of multivariate normality output for the entrenches a high-performance culture in the unit subscale*

Skewness			Kurtosis			Skewness and Kurtosis	
Value	z-score	p-value	Value	z-score	p-value	Chi-Square	p-value
16.126	5.558	.000	134.055	4.393	.000	50.188	.000

As per Table 5.42, it was again clear that the null hypothesis that the indicator variable distribution in the parameter follows a multivariate normal distribution had to be rejected (due to a statistically significant skewness and kurtosis chi-squared statistic;  $p < .05$ ). Hence, the assumption of multivariate normality did not hold and the first-order *entrenches a high-performance culture in the unit* measurement model was also fitted via RML as is shown in Figure 5.4 below.

The first-order *entrenches a high-performance culture in the unit* measurement model obtained excellent fit in the parameter. This conclusion was made as the Satorra-Bentler chi-squared statistic delivered a statistically non-significant value ( $\chi^2 = 45.65$ ;  $p > .05$ ), meaning that the exact fit null hypothesis could not be rejected. This implied that the measurement model was able to reproduce the observed covariance matrix to a degree of accuracy that could be explained in terms of sampling error alone. In line with expectations, the close fit null hypothesis (RMSEA = .048;  $p > .05$ ) could likewise not be rejected<sup>307</sup>. The standardised residuals corroborated this finding as the LISREL output revealed that the measurement model only significantly ( $p < .01$ ) overestimated ( $\leq -2.58$ ) (-3.003 and -3.446) and significantly ( $p < .01$ ) underestimated ( $\geq 2.58$ ) two values (5.364 and 17.569) respectively out of the 55 variances and covariances observed in the covariance matrix (circa 7%).

<sup>307</sup> The full array of fit statistics produced by LISREL 8.8 is shown in Appendix H.

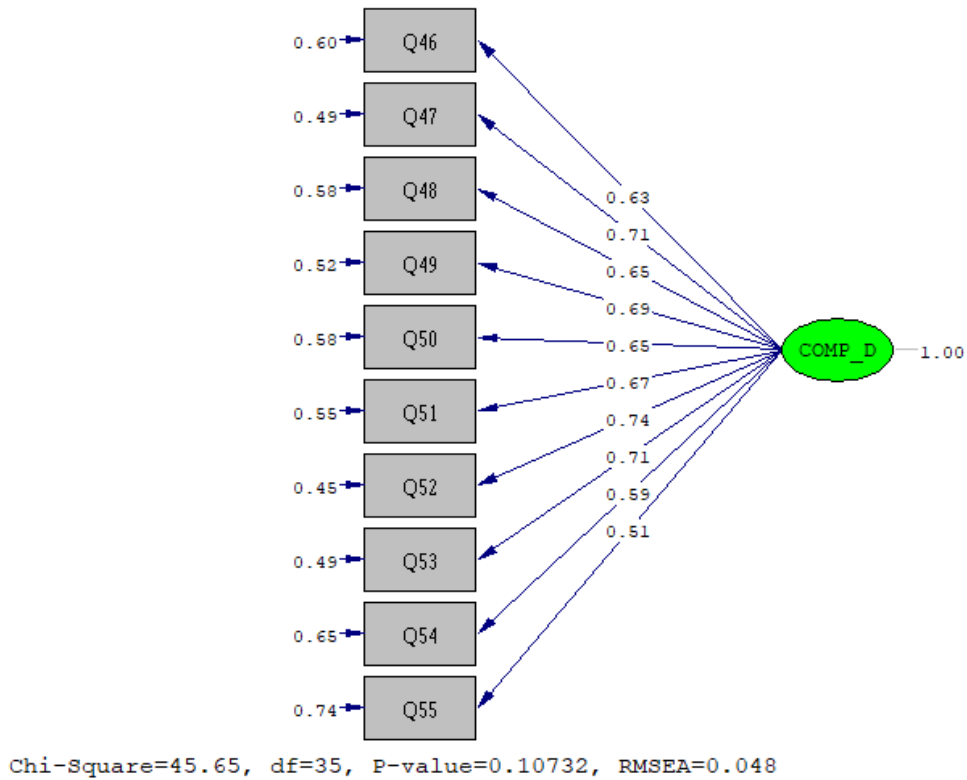

Figure 5.4. First-order entrenches a high-performance culture in the unit measurement model (completely standardised solution)

All indications therefore consistently supported the claim of unidimensionality for the *entrenches a high-performance culture in the unit* subscale. Moreover, the good fit of the model warranted the interpretation of the statistical significance and magnitude of the measurement model parameter estimates. The unstandardised factor loading matrix ( $\Lambda^X$ ) is shown in Table 5.43.

Table 5.43

*Unstandardised factor loading matrix ( $\Lambda^X$ ) for the entrenches a high-performance culture in the unit measurement model*

Item	COMP_D
Q46	0.4800* (0.0564) 8.5177
Q47	0.6333* (0.0625) 10.1246
Q48	0.5546* (0.0710) 7.8120
Q49	0.5585* (0.0597) 9.3542
Q50	0.5024* (0.0624) 8.0471
Q51	0.5851* (0.0620) 9.4417
Q52	0.6192*

(0.0538)  
11.5174

---

Table 5.43

*Unstandardised factor loading matrix ( $\Lambda^x$ ) for the entrenches a high-performance culture in the unit measurement model (continued)*

Item	COMP_D
Q53	0.6157* (0.0745)
Q54	8.2657 0.4625* (0.0637)
Q55	7.2635 0.4346* (0.0671)
	6.4788

Note: the first row in each cell in column 2 of Table 5.43 represents the unstandardised factor loading estimate ( $\lambda_{ij}$ ), row two (in brackets) represents the standard error and the third row represents the unstandardised estimate transformed to a z-score obtained by dividing the unstandardised estimate by its standard error.

\*p < .05

Table 5.43 shows that all the items of the subscale statistically significantly ( $p < .05$ ) load on the single *entrenches a high-performance culture in the unit* graduate leader competency. The (null hypothesis) position that the item responses are unrelated to graduate leaders' standing on the *entrenches a high-performance culture in the unit* competency can therefore be rejected. The factor loading estimates shown in Table 5.43 may therefore be generalised as point estimates of the slope of the regression of the items on the latent graduate leader competency in the population.

The completely standardised factor loading matrix ( $\Lambda^x$ ) for the *entrenches a high-performance culture in the unit* subscale is shown in Table 5.44.

Table 5.44

*Completely standardised factor loading matrix ( $\Lambda^x$ ) for the entrenches a high-performance culture in the unit measurement model*

Item	COMP_D
Q46	.6349
Q47	.7142
Q48	.6500
Q49	.6930
Q50	.6485
Q51	.6737
Q52	.7428
Q53	.7136
Q54	.5928
Q55	.5096

Table 5.44 indicates that all the items of the *entrenches a high-performance culture in the unit* subscale returned completely standardised factor loadings that surpassed the critical cut-off value of .50.

The unstandardised measurement error variance matrix for the *entrenches a high-performance culture in the unit* subscale is shown in Table 5.45 and the completely standardised measurement error variance matrix in Table 5.46.



Table 5.45

*Unstandardised measurement error variance matrix ( $\Theta_{\delta}$ ) for the entrenches a high-performance culture in the unit measurement model*

Q46	Q47	Q48	Q49	Q50	Q51
0.3411*	0.3852*	0.4204*	0.3376*	0.3478*	0.4119*
(0.0471)	(0.0556)	(0.0639)	(0.0457)	(0.0505)	(0.0640)
7.2499	6.9296	6.5750	7.3798	6.8933	6.4322
Q52	Q53	Q54	Q55		
0.3115*	0.3653*	0.3949*	0.5384*		
(0.0519)	(0.0518)	(0.0523)	(0.0655)		
6.0063	7.0474	7.5474	8.2258		

Note: the first row in each cell in each column of Table 5.45 represents the unstandardised measurement error variance estimate ( $\theta_{\delta ii}$ ), row two (in brackets) represents the standard error and the third row represents the unstandardised estimate transformed to a z-score obtained by dividing the unstandardised estimate by its standard error.

\*p < .05

Table 5.46

*Completely standardised measurement error variance matrix ( $\Theta_{\delta}$ ) for the entrenches a high-performance culture in the unit measurement model*

Q46	Q47	Q48	Q49	Q50	Q51
.5969	.4900	.5775	.5198	.5795	.5461
Q52	Q53	Q54	Q55		
.4482	.4908	.6486	.7404		

An inspection of the unstandardised measurement error variance matrix (Table 5.45) shows that all the items of the subscale were statistically significantly ( $p < .05$ ) plagued by systematic and random measurement error. The completely standardised theta-delta matrix (Table 5.46) for this measurement model, in turn, revealed measurement error variances for all items that ranged between .448 and .597 (except for Q54 at .648 and Q55 at .740). Upon closer investigation of the latter matrix, it was thus clear that for all items the completely standardised measurement error variance fell below the critical value of .75 implied by the critical value chosen for the completely standardised factor loadings. But for items Q54 and Q55, the remaining items' extraneous variance accounted for between 49% and 60% of the item variance.

The amount of variance accounted for in the subscale's items by the latent factor underlying the subscale, on the other hand, is presented in Table 5.47 below.

Table 5.47

*R<sup>2</sup> values for the entrenches a high-performance culture in the unit measurement model*

Q46	Q47	Q48	Q49	Q50
.403	.510	.422	.480	.420
Q51	Q52	Q53	Q54	Q55
.453	.551	.509	.351	.259

The magnitude of the respective R<sup>2</sup> values obtained for the items in this subscale ranged between .403 and .551 (except for Q54 with a value of .351 and Q55 with a value of .259). Practically, this meant that for the majority of subscale items, between 40% and 55% of the variance in the items could be attributed to the overarching factor that the subscale was meant to reflect. Ultimately, and while it was apparent that Q54 and Q55 were plagued by systematic and random measurement error, these results (i.e. R<sup>2</sup> magnitudes) in combination with the fact that the measurement model obtained exact fit in the parameter, and that the fitted measurement model succeeded in accurately reproducing 93% of the unique variance and covariances in the observed covariance matrix ultimately swayed the researcher's decision in retaining all the items of the subscale as psychometrically reasonably successful indicators of the latent *entrenches a high-performance culture in the unit graduate leader competency*.

The researcher again opted for the use of McDonald's omega as the definitive indicator for the reliability for this subscale, which proved to be satisfactory ( $> .80$ ). McDonald's omega ( $\omega = .884$ ) calculated via JASP was again only slightly larger than the Cronbach alpha ( $\alpha = .883$ ) that was reported as part of the SPSS item analysis output for this subscale (Table 5.41). Nonetheless, this implied that approximately 84% of the variance in the items included in the scale was true score variance, and only 16% was due to random error.

## 5.5.5 PSYCHOMETRIC EVALUATION OF THE 'DEVELOPS UNIT COMPETITIVENESS' SUBSCALE

### 5.5.5.1 Item analysis

The *develops unit competitiveness* subscale intended to measure the extent to which a graduate leader develops and secures resources for exploiting viable, eco-friendly and sustainable opportunities necessary for the occupation of a morally superior, winning market position for the unit (or team). As was discussed in paragraph 5.3, this is the subscale that had the most missing values in the data set and it was postulated that an apparent inability (or reticence) to respond to this scale occurred due to graduates not receiving the required training and development or not being exposed to the required real-life opportunities that would allow raters to meaningfully respond to all of the items included this subscale. Items 59, 60, 62, 64 and 66 were singled out in this regard.

Despite the relatively high number of missing values for this subscale the item analysis for this subscale, nonetheless, fortunately still yielded acceptable results. The typical response of the average participant (see Table 5.48 below) to this scale was lower than the previous scales (item means ranged from .2804 to 3.849 on a 5-point scale), while the item standard deviations ranged from .758 to 1.117. Participant ratings therefore gravitated around the midpoint (i.e. 3.3 out of 5; the satisfactory response option) of the subscale and their ratings was relatively spread out around this area. Intuitively the relatively lower scores allocated to this subscale (as opposed to the other subscales) made sense, as it was suggested previously that participants had the most trouble rating this scale as evidenced from the number of missing responses that occurred here. This notwithstanding, it still appeared as if the subscale had the ability to sufficiently discriminate between participants' responses in measuring the latent construct underlying it, as there were no truncated item distributions, extreme means and no small standard deviations evident in the SPSS item statistics output.

Table 5.48

#### *Item analysis output for the develops unit competitiveness subscale*

Reliability Statistics			
	Cronbach's Alpha	N of Items	
	.895	10	

Item Statistics			
	Mean	Std. Deviation	N
Q57	2.80451	1.117754	133
Q58	3.32331	.900748	133
Q59	3.12030	.977300	133
Q60	3.24812	.873915	133
Q61	3.84962	.811809	133
Q62	3.12030	1.101222	133
Q63	3.39850	.758186	133
Q64	3.08271	1.108132	133
Q65	3.48872	.867044	133
Q66	3.27820	1.010201	133

Inter-Item Correlation Matrix										
	Q57	Q58	Q59	Q60	Q61	Q62	Q63	Q64	Q65	Q66
Q57	1.000	.439	.472	.508	.235	.352	.361	.258	.193	.377
Q58	.439	1.000	.403	.581	.336	.289	.387	.337	.388	.325

Table 5.48

*Item analysis output for the develops unit competitiveness subscale (continued)*

	Q57	Q58	Q59	Q60	Q61	Q62	Q63	Q64	Q65	Q66
Q59	.472	.403	1.000	.577	.500	.507	.456	.508	.377	.557
Q60	.508	.581	.577	1.000	.512	.473	.467	.471	.399	.488
Q61	.235	.336	.500	.512	1.000	.368	.418	.570	.493	.504
Q62	.352	.289	.507	.473	.368	1.000	.586	.619	.557	.623
Q63	.361	.387	.456	.467	.418	.586	1.000	.610	.600	.636
Q64	.258	.337	.508	.471	.570	.619	.610	1.000	.659	.710
Q65	.193	.388	.377	.399	.493	.557	.600	.659	1.000	.657
Q66	.377	.325	.557	.488	.504	.623	.636	.710	.657	1.000

Item-Total Statistics					
	Scale Mean if Item Deleted	Scale Variance if Item Deleted	Corrected Item-Total Correlation	Squared Multiple Correlation	Cronbach's Alpha if Item Deleted
Q57	29.90977	39.537	.475	.381	.898
Q58	29.39098	40.679	.520	.418	.892
Q59	29.59398	38.379	.671	.503	.883
Q60	29.46617	39.175	.688	.562	.882
Q61	28.86466	40.648	.595	.451	.888
Q62	29.59398	37.213	.673	.531	.883
Q63	29.31579	40.172	.699	.530	.883
Q64	29.63158	36.492	.728	.643	.878
Q65	29.22556	39.524	.659	.586	.884
Q66	29.43609	37.111	.758	.653	.876

Summary Item Statistics							
	Mean	Minimum	Maximum	Range	Maximum /	Variance	N of Items
Item Means	3.271	2.805	3.850	1.045	1.373	.078	10
Item Variances	.923	.575	1.249	.675	2.173	.061	10
Inter-Item Correlations	.470	.193	.710	.517	3.677	.015	10

Table 5.48 also includes the subscale's inter-item correlation matrix, from which acceptable inter-item correlations were evident in the majority of the cases. Q57 and Q58 were flagged here as potential problematic items as they consistently correlated to a lower extent with the other items in the subscale. Nonetheless, the level of inter-item correlations displayed by Q57 and Q58 were not regarded as critically low, except in the isolated case of the Q57 and Q65 inter-item correlation (.193). Neither item Q57 nor item Q58 though correlated consistently lower than the mean inter-item correlation (.470) with the remaining items of the subscale. Moreover, as the "Cronbach alpha if deleted" column suggested that the overall scale reliability (.895) would not increase substantially if any one of these items were to be deleted, the researcher did not deem it necessary to remove items Q57 and Q58 from the subscale on the face of this evidence alone. Finally, upon inspection of the corrected inter-item correlations output it was evident that there were no convincing extreme outliers towards the lower end of this distribution. The subscale's squared multiple correlations also ranged from .381 to .653, demonstrating that there were no clear extreme outliers towards the lower end of this distribution as well. Item Q57 could possibly have been tagged as approaching outlier status in the squared multiple correlation distribution but was not considered sufficiently deviant to be yellow carded. Based on the basket of evidence available, all the items were therefore retained for this subscale.

### 5.5.5.2 Dimensionality analysis

The PRELIS output used for analysing the distributional properties of the *develops unit competitiveness* subscale is presented in Table 5.49 below.

Table 5.49

*PRELIS test of multivariate normality output for the develops unit competitiveness subscale*

Value	Skewness		Value	Kurtosis		Skewness and Kurtosis	
	z-score	p-value		z-score	p-value	Chi-Square	p-value
17.778	6.780	.000	142.719	5.940	.000	81.257	.000

The test of multivariate normality for this subscale again delivered a statistically significant skewness and kurtosis chi-square statistic ( $p < .05$ ). Subsequently, the researcher rejected the null hypothesis that the indicator variable distribution in the parameter was multivariate normal in nature. As the assumption of multivariate normality did not hold, the first-order *develops unit competitiveness* measurement model was also fitted via RML as shown in Figure 5.5 below.

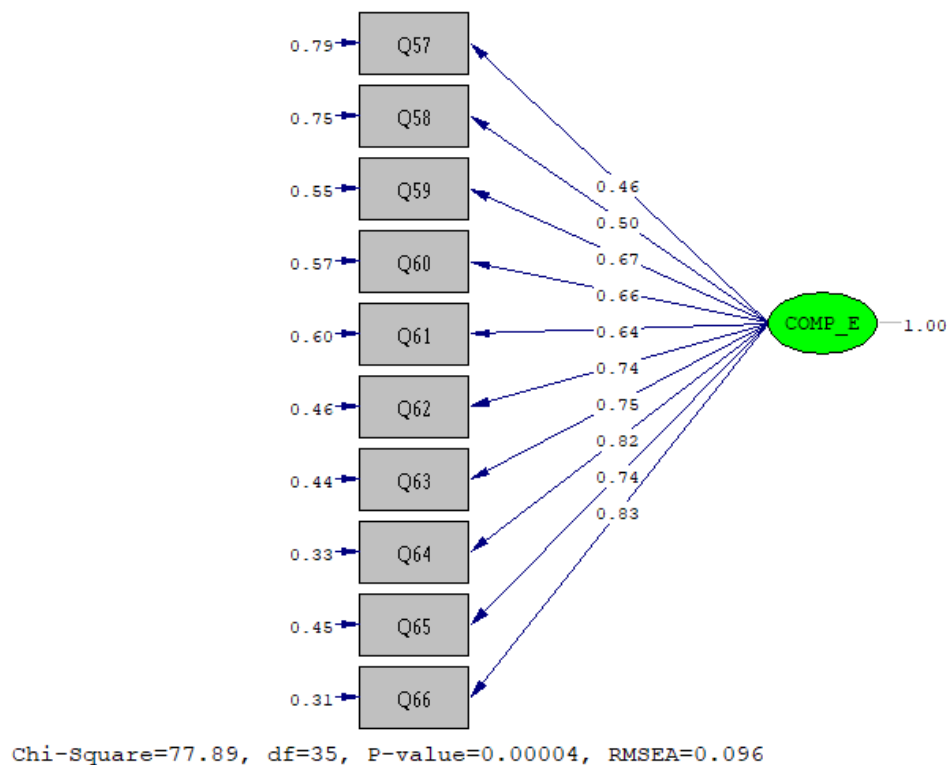

Figure 5.5. First-order *develops unit competitiveness* measurement model (completely standardised solution)

Unfortunately, this is the first of the PGLCQ measurement models that obtained poor fit in the parameter. Poor fit was concluded as the null hypothesis of exact fit, measured by the Satorra-Bentler scaled chi-square ( $\chi^2 = 77.89$ ;  $p < .05$ ) and the null hypothesis of close fit, as measured by RMSEA (.096), both had to be rejected ( $p < .05$ )<sup>308</sup>. Three large standardised covariance residuals (5.5%) were evident. One covariance term was significantly ( $p < .01$ ) overestimated (-8.8638) and two covariance terms were significantly ( $p < .01$ ) underestimated (2.7859 and 2.5977).

<sup>308</sup> The full array of fit statistics produced by LISREL 8.8 is shown in Appendix H. The general picture that emerges from the full array of fit statistics was interpreted to also point to less than satisfactory model fit. It is nonetheless conceded that the fit statistics were not totally unanimous in their verdict. The small percentage large standardised covariance residuals also argue against the conclusion of poor model fit.

The fact that not even a finding of close fit was permissible implied that the unidimensionality assumption underlying this measurement model had to be rejected and that the researcher had to revert to an exploratory factor analysis in order to further scrutinise the subscale's underlying factor structure for more clarification. For this purpose, the researcher utilised the principle axis factor method with oblimin rotation via SPSS, after which a two-factor solution emerged based on the Kaiser-rule within 5 iterations. The pattern matrix that emerged is presented in Table 5.50 below.

Table 5.50

*EFA Pattern matrix for the develops unit competitiveness subscale*

	Pattern Matrix	
	Factor	
	1	2
Q64	<b>.902</b>	-.074
Q65	<b>.860</b>	-.119
Q66	<b>.814</b>	.042
Q63	<b>.668</b>	.118
Q62	<b>.661</b>	.100
Q61	<b>.483</b>	.204
Q60	.096	<b>.772</b>
Q57	-.080	<b>.709</b>
Q58	.036	<b>.624</b>
Q59	.290	<b>.508</b>

Note: Bold factor loadings indicate the factor predominantly reflected by each item. Factor loadings are partial regression coefficients reflecting the influence of each factor on each item when controlling for the other factor. The latter is important because the factors to some degree share common variance due to the correlation between factors.

The pattern matrix clearly revealed the existence of a two-factor structure underlying this subscale. Q61 to Q66 loaded ( $\lambda_{ij}$  magnitudes ranged between .483 and .902) onto Factor 1, and Q57 to Q60 loaded ( $\lambda_{ij}$  magnitudes ranged between .508 and .772) onto Factor 2. Upon closer inspection it was evident that Factor 1 (e.g. themes relating to overall impact on unit performance, process performance, profit, product/service output) could be interpreted as the more traditional understanding of organisational competitiveness in terms of the output delivered in the unit and the extent to which the graduate's contributions to a unit's performance strategy stimulated such output, while Factor 2 (e.g. themes relating to green performance, buy-in from constituents, societal welfare in general) could be interpreted in terms of a more recent conceptualisation of organisational competitiveness and performance (or business) strategy focusing on aspects such as sustainability, conservation and constituent welfare, and how the graduate's contributions to a unit's performance strategy brought about such outcomes. The factor fission was therefore considered conceptually meaningful, as both of these two "themes" represent logical facets of the *develops unit competitiveness* (second-order) competency that the subscale was originally designed to measure. Furthermore, the number of items that loaded on factor 2 gave credence to the factor. Moreover, the factor correlation matrix returned a moderate positive correlation of .632 implying a not overly excessive circa 40% shared variance between the two factors. In addition, it was argued that the conceptual distinction between the more traditional and the more progressive interpretations of organisational competitiveness will be of value in providing formative feedback to graduate leaders during their leadership development programme.<sup>309</sup>

The evaluation of fit for this two-factor measurement model, as guided by the SPSS two-factor pattern matrix and as presented in Figure 5.6 below in the subsequent CFA, proved to be

<sup>309</sup> An alternative to the acceptance of a more complex factor structure than what was originally envisaged with the development of the PGLCQ was to delete at least items Q57, Q58 and Q60 (and possibly item Q59 as well). This would have ensured that the unidimensionality assumption is corroborated for the reduced *develops unit competitiveness* subscale. This would have, however, substantially reduced the connotative meaning of the latent graduate leader competency measured by the subscale. Following the acknowledging of the factor fission might, however, depending on the reliability results, necessitate the creation of additional items for the two facets of the *develops unit competitiveness graduate leader competency in a subsequent version of the PGLCQ*.

extremely favourable. The Satorra-Bentler scaled chi-square statistic delivered a statistically non-significant value ( $\chi^2 = 43.446$ ;  $p > .05$ ), meaning that the exact fit null hypothesis could not be rejected<sup>310</sup>. This implied that the two-factor measurement model was able to reproduce the observed covariance matrix to a degree of accuracy that could be explained in terms of sampling error alone. In line with expectations, the close fit null hypothesis (RMSEA = .046;  $p > .05$ ) could likewise not be rejected. An investigation into the measurement model's standardised residuals output revealed that only one value was significantly ( $p < .01$ ) overestimated ( $\leq -.258$ ) (-6.211) and significantly ( $p < .01$ ) underestimated ( $\geq 2.58$ ) (2.652) respectively out of the 55 variances and covariances observed in the covariance matrix (circa 4%). The fitted (two-factor) measurement model therefore succeeded in accurately reproducing circa 96% of the unique variance and covariances in the observed covariance matrix. This finding of improved fit warranted the investigation of some of the new (two-factor) measurement model's parameters.

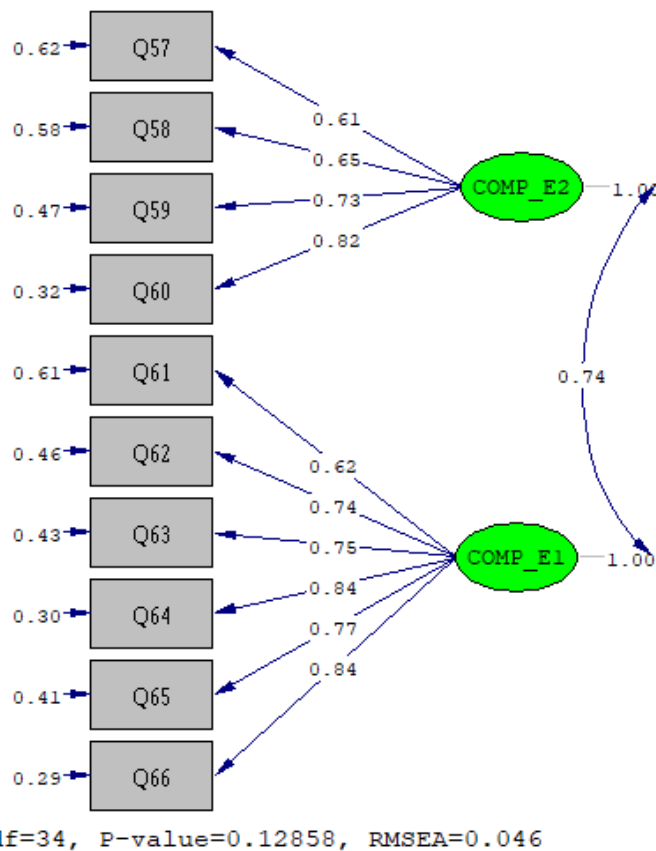

Figure 5.6. First-order *two-factor develops unit competitiveness* measurement model (completely standardised solution)

The unstandardised factor loading matrix ( $\Lambda^x$ ) for the two-factor *develops unit competitiveness* measurement model is shown in Table 5.51.

<sup>310</sup> The full array of fit statistics produced by LISREL 8.8 is shown in Appendix H.

Table 5.51

*Unstandardised factor loading matrix ( $\Lambda^x$ ) for the two-factor develops unit competitiveness measurement model*

Item	COMP E1	COMP E2
Q57	--	0.6868* (0.0942) 7.2917
Q58	--	0.5838* (0.0980) 5.9545
Q59	--	0.7126* (0.0830) 8.5883
Q60	--	0.7205* (0.0683) 10.5443
Q61	0.5057* (0.0620) 8.1629	--
Q62	0.8105* (0.0709) 11.4306	--
Q63	0.5722* (0.0590) 9.7022	--
Q64	0.9287* (0.0702) 13.2356	--
Q65	0.6681* (0.0691) 9.6705	--
Q66	0.8528* (0.0639) 13.3549	--

Note: the first row in each cell in columns 2 and 3 of Table 5.51 represents the unstandardised factor loading estimate ( $\lambda_{ij}$ ), row two (in brackets) represents the standard error and the third row represents the unstandardised estimate transformed to a z-score obtained by dividing the unstandardised estimate by its standard error.

\*p < .05

Table 5.51 shows that all the items of the *develops unit competitiveness* subscale statistically significantly ( $p < .05$ ) reflect the factor that they were designated to represent according to the pattern matrix (Table 5.50) obtained from the EFA. The null hypotheses that  $\lambda_{ij} = 0$  in the parameter could therefore be rejected for all items.

The completely standardised factor loading matrix ( $\Lambda^x$ ) for the two-factor *develops unit competitiveness* measurement model is shown in Table 5.52.

Table 5.52

*Completely standardised factor loading matrix ( $\Lambda^x$ ) for the two-factor develops unit competitiveness measurement model*

Item	COMP_E1	COMP_E2
Q57	--	.6145
Q58	--	.6481
Q59	--	.7292
Q60	--	.8244
Q61	.6229	--
Q62	.7360	--
Q63	.7547	--
Q64	.8381	--
Q65	.7705	--
Q66	.8442	--

Table 5.52 indicates that all items show satisfactory factor loadings on their respective factors.<sup>311</sup>

The unstandardised measurement error variance matrix for the two-factor *develops unit competitiveness* measurement model is shown in Table 5.53 and the completely standardised measurement error variance matrix in Table 5.54.

Table 5.53

*Unstandardised measurement error variance matrix ( $\Theta_{\delta}$ ) for the two-factor develops unit competitiveness measurement model*

Q57	Q58	Q59	Q60	Q61	Q62
0.7776*	0.4706*	0.4473*	0.2446*	0.4033*	0.5558*
(0.1164)	(0.0868)	(0.0754)	(0.0556)	(0.0569)	(0.0903)
6.6783	5.4232	5.9342	4.3997	7.0867	6.1542
Q63	Q64	Q65	Q66		
0.2474*	0.3654*	0.3054*	0.2933*		
(0.0385)	(0.0699)	(0.0545)	(0.0484)		
6.4329	5.2281	5.6039	6.0626		

Note: the first row in each cell in each column of Table 5.53 represents the unstandardised measurement error variance estimate ( $\theta_{\delta ii}$ ), row two (in brackets) represents the standard error and the third row represents the unstandardised estimate transformed to a z-score obtained by dividing the unstandardised estimate by its standard error.

\*p < .05

Table 5.54

*Completely standardised measurement error variance matrix ( $\Theta_{\delta}$ ) for the two-factor develops unit competitiveness measurement model*

Q57	Q58	Q59	Q60	Q61	Q62
.6224	.5800	.4683	.3203	.6119	.4583
Q63	Q64	Q65	Q66		
.4304	.2976	.4063	.2874		

Regarding measurement error, an inspection of the unstandardised measurement error variance matrix (Table 5.53) indicates that all items were statistically significantly plagued by systematic and random measurement error. The completely standardised theta-delta matrix for this two-factor measurement model revealed measurement error variances for all items that ranged between .287 and .580 (except for Q57 at .622 and Q61 at .611). In practical terms, this meant that measurement error accounted for only between a 29% and 58% range of variance in the majority of the items in this subscale.

On the other hand, the amount of item variance that was accounted for by the latent factors underlying this subscale is presented in Table 5.55 below. Here, it was found that for the majority of items, values ranged between .420 and .712, and therefore, it was concluded that between 42% and 71% of the variance in the majority of the subscale items could be accounted for by the underlying factor (i.e. Factor 1 and Factor 2) they were intended<sup>312</sup> to reflect.

<sup>311</sup> It is acknowledged that strictly speaking the .50 critical cut-off criterion that was imposed thus far on single-factor factor structures does not generalise to two-factor factor structures that allow the factors to be correlated. The critical cut-off of .50 was chosen as a minimally acceptable completely standardised factor loading because the latent competency then explains 25% of the variance in the item. The completely standardised factor loading in a single factor solution (or in an orthogonal multi-factor solution in which each item loads on a single factor) is a correlation coefficient. In the two-factor *develops unit competitiveness* measurement model, in which the two factors are allowed to correlate, the factor loadings should rather be thought of as partial regression coefficients.

<sup>312</sup> The word 'intended' used here is strictly speaking incorrect. The second-order competency of *develops unit competitiveness* was operationalised in Chapter 2 as a single (one-factor) latent variable. Given the conclusion of meaningful factor fission, however, the interpretation of the second-order competency of *develops unit competitiveness* was changed so as to accommodate a two-factor structure.



Table 5.55

*R<sup>2</sup> values for the develops unit competitiveness two-factor measurement model*

Q57	Q58	Q59	Q60	Q61
.377	.420	.531	.679	.388
Q62	Q63	Q64	Q65	Q66
.541	.569	.702	.593	.712

Ultimately the findings of exact fit, a low percentage of standardised residuals, the statistical significance ( $p < .05$ ) of the factor loadings, the reasonable magnitude of the completely standardised factor loadings, the existence of relatively low measurement error variance, and the magnitudes of the respective  $R^2$  values led the researcher to conclude that the fitted two-factor measurement model constituted a valid multidimensional (two-factor) explanation of the *develops unit competitiveness* inter-item covariance matrix.

The factor fission of the *develops unit competitiveness* subscale was regarded as conceptually and practically meaningful. The items of the current subscale provided psychometrically acceptable measures of the two extracted factors. However, the two sets of items comprising the current scale would have to be extended to provide separate measures of the two *develops unit competitiveness* facets with acceptable reliabilities. That leaves the question, in the interim and beyond, whether the items may also be regarded as statistically significant ( $p < .05$ ) indicators of a second-order *develops unit competitiveness* competency<sup>313</sup>.

To attempt to answer this question a second-order *develops unit competitiveness* measurement model was fitted with a single second-order *develops unit competitiveness* factor.<sup>314</sup> The excellent fit of the two-factor first-order *develops unit competitiveness* measurement model shown in Figure 5.6, combined with the moderate inter-factor correlation, justified the fitting of the second-order model. The completely standardised solution for the fitted two-factor second-order *develops unit competitiveness* measurement model is shown in Figure 5.7.

<sup>313</sup> It is acknowledged that yet again the use of the term second-order competency raises the real danger of semantic confusion. The latent graduate leadership *develops unit competitiveness* competency that the PGLCQ intended to measure was in itself conceptually a second-order competency that was derived logically from an identified set of first-order competencies. Items were written to tap into the common theme shared by the first-order competencies that were thought to conceptually load onto the second-order factor. Moreover, the latent second-order graduate leader competencies were conceptualised as unidimensional latent variables. However, in the empirical analyses all nine latent graduate leader competencies targeted by the PGLCQ were effectively treated as if they were first-order factors. In the event of factor fission the emerging first-order factors are in the larger framework, actually (correlated) second-order factors, and the second-order that the main text refers to, is actually a third-order factor.

<sup>314</sup> Diagonally weighted least squares estimation was used rather than robust maximum likelihood estimation.

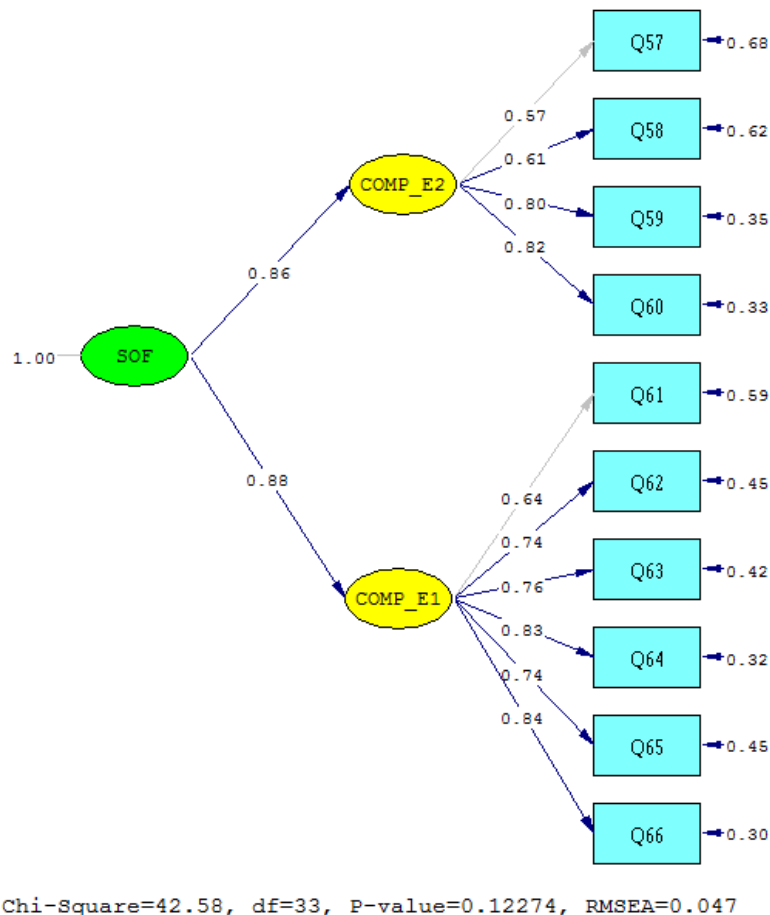

Figure 5.7. Second-order two-factor *develops unit competitiveness* measurement model (completely standardised solution)

The Satorra-Bentler scaled chi-square returned a statistically insignificant estimate (42.5779;  $p > .05$ ). The exact fit null hypothesis ( $H_{0i}$ : RMSEA = 0) therefore needed not to be rejected. The observed sample RMSEA estimate (.04689) could thus be fully explained in terms of sampling error. It therefore followed that the close fit null hypothesis ( $H_{0i}$ : RMSEA  $\leq$  .05) also needed not to be rejected.<sup>315</sup> None of the standardised variance-covariance residuals exceeded the value of 2.58. The excellent fit obtained for the second-order two-factor *develops unit competitiveness* measurement model justified the calculation of the indirect effects of the second-order factor on the *develops unit competitiveness* subscale items, and the testing of their statistical significance.

For this purpose, the SIMPLIS syntax used to fit the second-order two-factor *develops unit competitiveness* measurement model was translated to LISREL syntax. This allowed the use of the LISREL syntax command AP on the model command line to specify the creation of 10 additional parameters (i.e., the indirect effects) and the CO command to specify the ten indirect effects to be calculated<sup>316</sup>. The unstandardised indirect effects are shown in Table 5.56.

<sup>315</sup> The full array of fit statistics produced by LISREL 8.8 is shown in Appendix H.

<sup>316</sup> CO PAR1 = GA(2,1)\*LY(1,2)  
 CO PAR2 = GA(2,1)\*LY(2,2)  
 CO PAR3 = GA(2,1)\*LY(3,2)  
 CO PAR4 = GA(2,1)\*LY(4,2)  
 CO PAR5 = GA(1,1)\*LY(5,1)  
 CO PAR6 = GA(1,1)\*LY(6,1)  
 CO PAR7 = GA(1,1)\*LY(7,1)

Table 5.56

*Unstandardised indirect effects of the second-order factor on the develops unit competitiveness subscale items*

PA(1)	PA(2)	PA(3)	PA(4)	PA(5)	PA(6)
0.55*	0.48*	0.68*	0.62*	0.46*	0.71*
(0.09)	(0.09)	(0.09)	(0.09)	(0.09)	(0.09)
6.27	5.46	7.78	7.07	5.25	8.18
PA(7)	PA(8)	PA(9)	PA(10)		
0.50*	0.80*	0.57*	0.74*		
(0.09)	(0.09)	(0.09)	(0.09)		
5.79	9.20	6.50	8.53		

Note: the first row in each cell in each column of Table 5.56 represents the unstandardised indirect effect estimate PA<sub>i</sub> row two (in brackets) represents the standard error and the third row represents the unstandardised estimate transformed to a z-score obtained by dividing the unstandardised estimate by its standard error.

\*p < .05

Table 5.56 shows that the second-order factor statistically significantly ( $p < .05$ ) affected each of the ten *develops unit competitiveness* subscale items. The statistical significance of the indirect effects presented in Table 5.56 above implies that the *develops unit competitiveness* subscale items, despite measuring two distinct factors, could therefore still be regarded as composite indicators of a higher-order *develops unit competitiveness* competency. This warrants the calculation of total scores from the ten *develops unit competitiveness* subscale items and to interpret it as indicators of the second-order *develops unit competitiveness* factor. It follows that the different items measuring factor 1 and factor 2 of this subscale accordingly had to be treated as subtests of the same higher-order *develops unit competitiveness* competency – i.e. they were acknowledged to measure two different strata of the same latent (higher-order) construct rather than two entirely unrelated constructs. In future, once the subscale has been extended in a revised version of the PGLCQ, facet scores on two narrower first-order factors could also be interpreted.

Because of the factor fission, instead of calculating and reporting the McDonald omega reliability coefficient for this subscale as was the *modus operandi* up until now, the researcher decided to use the theoretically more correct Stratified alpha<sup>317</sup> alternative here that is more appropriate for use when estimating the internal consistency reliability of a composite score. Accordingly, the researcher utilised an Excel macro prepopulated with the formula for the Stratified  $\alpha$ <sup>318</sup>, and inputted the following values in calculating this reliability coefficient for the subscale:

- The Cronbach alpha coefficient calculated for the set of items measuring factor 1 ( $\alpha_1 = .887$ );
- The Cronbach alpha coefficient calculated for the set of items measuring factor 2 ( $\alpha_2 = .791$ )<sup>319</sup>;
- The variance of the total scores of the item set measuring factor 1 ( $S^2_1 = 20.899$ );
- The variance of the total scores of the item set measuring factor 2 ( $S^2_2 = 9.297$ ); and
- The variance of the total scores of the entire subscale item set (measuring both factor 1 and 2) ( $S^2_t = 47.463$ ).

The macro returned a result of Stratified  $\alpha = .909$  (while the item analysis output for this (composite) subscale delivered a Cronbach Alpha value of .895). This implied an excellent level of internal consistency reliability for this composite subscale (e.g. Clark & Watson, 1995; Nunnally

---

CO PAR8 = GA(1,1)\*LY(8,1)

CO PAR9 = GA(1,1)\*LY(9,1)

CO PAR10 = GA(1,1)\*LY(10,1)

<sup>317</sup> Stratified  $\alpha$  was introduced by Cronbach, Schoneman, and McKie (1965). This reliability coefficient is more suitable for estimating the reliability of measures that are composed of several subtests or components.

<sup>318</sup> See Widhiarso and Ravand (2014) for the exact formula for Stratified alpha.

<sup>319</sup> The reliability of the second *develops unit competitiveness* facet suggests that the expansion of the current *develops unit competitiveness* subscale would be desirable before interpreting the facet scores in practical applications.

& Bernstein, 1994) – i.e. that approximately 91% of the variance in its items was because of true score variance, and that only approximately 9% of variance was due to random error.

## 5.5.6 PSYCHOMETRIC EVALUATION OF THE 'INVOLVES OTHERS AND ELICITS PARTICIPATION' SUBSCALE

### 5.5.6.1 Item analysis

The *involves others and elicits participation* subscale intended to measure the extent to which a graduate leader provides scope and opportunities for followers to spontaneously contribute their talents/capabilities to the unit or the unit's (or team's) performance process. As was the case with the *creates an exciting and aspirational vision for the unit* subscale, the results of the item analysis for this subscale were extremely favourable. Inspection of the item statistics SPSS output as per Table 5.57 below revealed that the item means for this subscale ranged from 3.248 to 3.616 on a 5-point scale and that the item standard deviations ranged from .713 to .891. On this subscale, participants therefore typically rated their performance (or that of their subordinate) at above the midpoint (i.e. 3.2 to 3.6; as satisfactory) of the scale while responses in general was somewhat spread out around these means. No items showed themselves as outliers in the item standard deviation distribution. The implication of this finding was again that the researcher could not find evidence of truncated or extreme means nor the presence of small standard deviations, and therefore it was concluded that the subscale was able to sufficiently discriminate between participant responses in measuring the latent (not necessarily unidimensional) construct underlying the subscale.

Table 5.57

*Item analysis output for the involves others and elicits participation subscale*

Reliability Statistics	
Cronbach's Alpha	N of Items
.850	10

Item Statistics			
	Mean	Std. Deviation	N
Q68	3.61654	.823167	133
Q69	3.36842	.820880	133
Q70	3.24812	.752833	133
Q71	3.45113	.891595	133
Q72	3.48120	.713522	133
Q73	3.30827	.871957	133
Q74	3.48120	.784330	133
Q75	3.42857	.890061	133
Q76	3.74436	.849725	133
Q77	3.52632	.803203	133

Inter-Item Correlation Matrix										
	Q68	Q69	Q70	Q71	Q72	Q73	Q74	Q75	Q76	Q77
Q68	1.000	.368	.387	.382	.278	.377	.370	.278	.509	.422
Q69	.368	1.000	.464	.403	.290	.316	.358	.373	.310	.393
Q70	.387	.464	1.000	.340	.382	.367	.309	.270	.372	.221
Q71	.382	.403	.340	1.000	.311	.414	.359	.337	.353	.480
Q72	.278	.290	.382	.311	1.000	.442	.192	.377	.329	.361
Q73	.377	.316	.367	.414	.442	1.000	.369	.395	.393	.362
Q74	.370	.358	.309	.359	.192	.369	1.000	.277	.356	.401
Q75	.278	.373	.270	.337	.377	.395	.277	1.000	.336	.466
Q76	.509	.310	.372	.353	.329	.393	.356	.336	1.000	.432
Q77	.422	.393	.221	.480	.361	.362	.401	.466	.432	1.000

Table 5.57

*Item analysis output for the involves others and elicits participation subscale (continued)*

Item-Total Statistics						
	Scale Mean if Item Deleted	Scale Variance if Item Deleted	Corrected Item-Total Correlation	Squared Multiple Correlation	Cronbach's Alpha if Item Deleted	
Q68	31.03759	23.506	.571	.376	.834	
Q69	31.28571	23.660	.552	.356	.836	
Q70	31.40602	24.304	.522	.361	.838	
Q71	31.20301	23.042	.573	.353	.834	
Q72	31.17293	24.705	.498	.314	.840	
Q73	31.34586	23.107	.582	.370	.833	
Q74	31.17293	24.235	.504	.287	.840	
Q75	31.22556	23.449	.522	.323	.839	
Q76	30.90977	23.310	.574	.373	.834	
Q77	31.12782	23.385	.607	.441	.831	

Summary Item Statistics							
	Mean	Minimum	Maximum	Range	Maximum /	Variance	N of Items
Item Means	3.465	3.248	3.744	.496	1.153	.021	10
Item Variances	.676	.509	.795	.286	1.561	.009	10
Inter-Item Correlations	.362	.192	.509	.316	2.646	.004	10

Inspection of the inter-item correlations also revealed favourable findings. Inter-item correlations did range from .192 to .509; however, there were only isolated cases where inter-item correlations dropped to less than .30. None of the items consistently correlated below the mean inter-item correlation (.362) with the remaining items of the subscale. Moreover, upon inspection of the "Cronbach alpha if deleted" output, it was evident that the overall Cronbach Alpha coefficient of the subscale (.850) would not improve if any of the items were to be removed from the subscale. Finally, an analysis of the subscale's items from the perspective of corrected item-total correlations and squared multiple correlations also yielded favourable findings. The corrected item-total correlations ranged between .498 and .607, thereby demonstrating that there were no outliers towards the extreme lower end of this distribution. The squared multiple correlations of the items ranged between .314 and .441 (except for Q74 at .287), again demonstrating that there were no convincing extreme outliers towards the lower end of this distribution. Based on this evidence, the researcher decided to retain all of the items for this subscale.

### 5.5.6.2 Dimensionality analysis

The PRELIS output used for analysing the distributional properties of the *involves others and elicits participation* subscale is presented in Table 5.58 below.

Table 5.58

*PRELIS test of multivariate normality output for the involves others and elicits participation subscale*

Skewness			Kurtosis			Skewness and Kurtosis	
Value	z-score	p-value	Value	z-score	p-value	Chi-Square	p-value
13.319	3.273	.001	130.510	3.634	.000	23.917	.000

As was the case with all of the subscales investigated thus far, it was again clear that the null hypothesis that the indicator variable distribution in the parameter follows a multivariate normal distribution had to be rejected (due to a statistically significant skewness and kurtosis chi-squared statistic  $p < .05$ ). Hence, the assumption of multivariate normality did not hold and the first-order *involves others and elicits participation* measurement model was also fitted via RML as is shown in Figure 5.8 below.

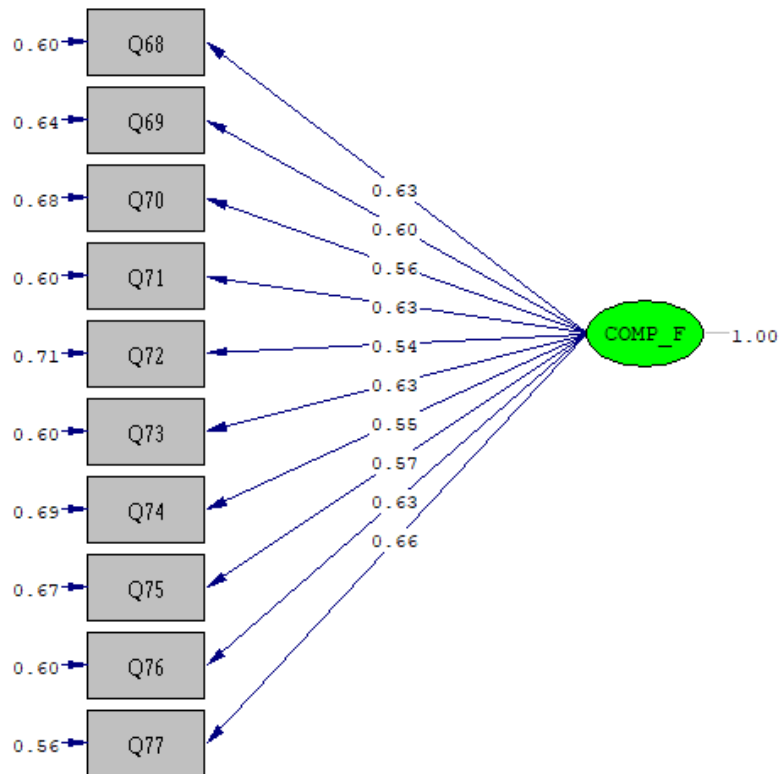

Chi-Square=39.35, df=35, P-value=0.28132, RMSEA=0.031

Figure 5.8. First-order *involves others and elicits participation* measurement model (completely standardised solution)

The first-order *involves others and elicits participation* measurement model obtained excellent fit in the parameter. This conclusion was made as the Satorra-Bentler chi-squared statistic delivered a statistically insignificant value ( $\chi^2 = 39.35$ ;  $p > .05$ ), meaning that the exact fit null hypothesis ( $H_{0i}$ : RMSEA = 0) did not need to be rejected. It therefore followed that the null hypothesis of close fit ( $H_{0i}$ : RMSEA  $\leq$  0) also needed not to be rejected (RMSEA = .031;  $p > .05$ )<sup>320</sup>. The standardised residuals output revealed that the measurement model only underestimated ( $\geq 2.58$ ) one value (2.845) out of the 55 variances and covariances observed in the covariance matrix (circa 2%). The fitted measurement model thus succeeded in accurately reproducing 98% of the unique variance and covariances in the observed covariance matrix, thereby supporting the earlier positive verdict of fit as per the RMSEA statistic presented above.

The good fit of the first-order single-factor *involves others and elicits participation* measurement model corroborates the unidimensionality assumption for this subscale. Moreover, the good fit of the model warranted the interpretation of the statistical significance and magnitude of the measurement model parameter estimates. The unstandardised factor loading matrix ( $\Lambda^x$ ) is shown in Table 5.59.

<sup>320</sup> The full array of fit statistics produced by LISREL 8.8 is shown in Appendix H.

Table 5.59

*Unstandardised factor loading matrix ( $\Lambda^x$ ) for the involves others and elicits participation measurement model*

Item	COMP_F
Q68	0.5185* (0.0749) 6.9189
Q69	0.49168* (0.0645) 7.6281
Q70	0.4237* (0.0593) 7.1431
Q71	0.5626* (0.0779) 7.2245
Q72	0.3861* (0.0689) 5.6036
Q73	0.5494* (0.0829) 6.6288
Q74	0.4352* (0.0748) 5.8218
Q75	0.5101* (0.0765) 6.6642
Q76	0.5371* (0.0832) 6.4563
Q77	0.5320* (0.0629) 8.4548

Note: the first row in each cell in column 2 of Table 5.59 represents the unstandardised factor loading estimate ( $\lambda_{ij}$ ), row two (in brackets) represents the standard error and the third row represents the unstandardised estimate transformed to a z-score obtained by dividing the unstandardised estimate by its standard error.

\*p < .05

Table 5.59 shows that all the items of the subscale statistically significantly load on the single *involves others and elicits participation* graduate leader competency. The null hypotheses  $H_{0i}: \lambda_{ij} = 0$  could therefore be rejected for all ten items. The claim that the item responses are systematically related to graduate leaders' level of competence on the *involves others and elicits participation* competency could therefore be generalised to the parameter.

The completely standardised factor loading matrix ( $\Lambda^x$ ) for the *involves others and elicits participation* subscale is shown in Table 5.60.

Table 5.60

*Completely standardised factor loading matrix ( $\Lambda^x$ ) for the involves others and elicits participation measurement model*

Item	COMP_F
Q68	.6299
Q69	.5989
Q70	.5628
Q71	.6310
Q72	.5411
Q73	.6301
Q74	.5549
Q75	.5731
Q76	.6321
Q77	.6624

Table 5.60 indicates that the completely standardised factor loadings for all ten items of the *involves others and elicits participation* subscale exceeded the critical cut-off value of .50. Despite this, the completely standardised loadings were rather modest in magnitude. This implies that the latent graduate leadership *involves others and elicits participation* competency explains relatively modest proportions of variance in each item albeit more than 25%.

The unstandardised measurement error variance matrix for the *involves others and elicits participation* subscale is shown in Table 5.61 and the completely standardised measurement error variance matrix in Table 5.62.

Table 5.61

*Unstandardised measurement error variance matrix ( $\Theta_{\delta}$ ) for involves others and elicits participation measurement model*

Q68	Q69	Q70	Q71	Q72	Q73
0.4087*	0.4321*	0.3872*	0.4784*	0.3600*	0.4585*
(0.0595)	(0.0614)	(0.0710)	(0.0782)	(0.0426)	(0.0691)
6.8712	7.0403	5.4570	6.1143	8.4528	6.6342
Q74	Q75	Q76	Q77		
0.4258*	0.5320*	0.4335*	0.3621*		
(0.0656)	(0.0870)	(0.0583)	(0.0534)		
6.4952	6.1157	7.4352	6.7849		

Note: the first row in each cell in each column of Table 5.61 represents the unstandardised measurement error variance estimate ( $\theta_{\delta i}$ ), row two (in brackets) represents the standard error and the third row represents the unstandardised estimate transformed to a z-score obtained by dividing the unstandardised estimate by its standard error.

\*p < .05

Table 5.62

*Completely standardised measurement error variance matrix ( $\Theta_{\delta}$ ) for the involves others and elicits participation measurement model*

Q68	Q69	Q70	Q71	Q72	Q73
.6032	.6413	.6833	.6018	.7072	.6030
Q74	Q75	Q76	Q77		
.6921	.6716	.6004	.5612		

An inspection of the unstandardised theta-delta matrix for the *involves others and elicits participation* measurement model shows that all the items of this subscale were statistically significantly ( $p < .05$ ) plagued by systematic and random measurement error. The completely standardised theta-delta matrix for this measurement model, in turn, echoed the conclusion reached from Table 5.60 that the items of the subscale were reasonably substantially plagued by measurement error with measurement error variances for all items that ranged between .561 and .707. By far the majority of the values, however, ranged between .561 and .641, implying that extraneous error accounted for between 56% and 64% of the variance in most items included in the subscale. This finding did not remark well on the validity of the subscale items, as one would have preferred a lower amount of extraneous variance influencing this subscale's item responses. The ideal when operationalising a latent variable through a multi-indicator measured operational definition is that the variance in  $X_i$  (or  $Y_i$ ) should be attributed only to the variance in  $\xi$  (or  $\eta$ ). While it could be argued that this is evidently not the case here, infallible measurement is generally accepted as an unattainable ideal and the researcher therefore held back on a decision on whether or not to remove some of the subscale's items based on this evidence, pending the outcome of an investigation into the extent to which the indicators were actually able to tap into the latent construct underlying the subscale first. The amount of variance accounted for in the subscale's items by the latent factor underlying the subscale is presented in Table 5.63 below.



Table 5.63

*R<sup>2</sup> values for the involves others and elicits participation measurement model*

Q68	Q69	Q70	Q71	Q72
.396	.358	.316	.398	.292
Q73	Q74	Q75	Q76	Q77
.397	.307	.328	.399	.438

The magnitude of the respective  $R^2$  values obtained for the items in this subscale was found to be moderate and ranged between .292 and .438, implying that only between 29% and 44% of the variance in the items could be attributed to the overarching factor that the subscale was meant to reflect. This finding again reaffirms the findings derived from Table 5.60 and Table 5.62. Although it did appear as if this subscale's items were somewhat plagued by extraneous error variance and one would have hoped for indicators that displayed greater power in terms of their ability to tap into the factor underlying this subscale here, in its entirety the basket of evidence collected for this subscale (i.e. reasonable fit, small percentage of residuals, small but definite to moderate factor loadings in terms of  $R^2$ ) once again prompted the researcher to support the position that the items of this subscale reasonably successfully operationalised the latent graduate leadership *involves others and elicits participation* competency.

Given this conclusion, the researcher again opted to calculate McDonald's omega coefficient as the definitive (and theoretically more correct) indicator of reliability for this subscale. In this case, McDonald's omega was once again found to be satisfactory ( $> .80$ ), yet interestingly enough, equal to the Cronbach alpha coefficient (Table 5.57) calculated for this subscale (both coefficients equalled .850). This suggests that the assumption of essential tau equivalence was not substantially violated here as indicated in Table 5.60. Nonetheless, this result indicated that approximately 85% of the variance in the subscale items occurred because of true score variance, and that only 15% of variance occurred due to random error variance. The reasonably satisfactory reliability finding came as somewhat of a surprise given the moderately high completely standardised measurement error variances (Table 5.62) and rather modest completely standardised factor loadings (Table 5.60) and  $R^2$  values (Table 5.63). This contrast suggests that the measurement error quite strongly comprised non-relevant systematic influences rather than random error influences. This contrast, moreover, quite strikingly illustrates the importance of not overemphasising subscale reliability at the expense of validity.<sup>321</sup>

## 5.5.7 PSYCHOMETRIC EVALUATION OF THE 'UNITES AND CONNECTS FOLLOWERS' SUBSCALE

### 5.5.7.1 Item Analysis

The *unites and connects followers* subscale intended to measure the extent to which a graduate leader brings followers together and unites them in fortified, mutually supportive relationships. The item analysis procedure for this subscale was conducted in the same way as was done for the other subscales evaluated thus far, and once again, the overall results of this analysis yielded favourable findings overall. Inspection of the item statistics SPSS output as per Table 5.64 below revealed item means (values ranged from 3.241 to 3.661) and item standard deviations (values ranged from .809 to 1.068) that were comparable to most of the other subscales investigated up until this point in the study. Participants typically rated their performance (or that of their subordinate) as satisfactory at slightly above the midpoint (i.e. 3.2 to 3.7) while responses in general were again relatively spread out around these means. Once again, on the face of this

<sup>321</sup> It is acknowledged that subscale reliability is a necessary but not sufficient prerequisite for subscale validity. The measures of a subscale can be quite reliable but the inferences derived from these reliable measures need not necessarily be highly valid. Highly valid construct referenced inferences from unreliable measures are, however, not possible.

evidence, it was concluded that the subscale was able to sufficiently discriminate between participant responses in measuring the latent construct underlying it.

Table 5.64

*Item analysis output for the unites and connects followers subscale*

Reliability Statistics	
Cronbach's Alpha	N of Items
.870	10

Item Statistics			
	Mean	Std. Deviation	N
Q79	3.33083	.943252	133
Q80	3.43609	1.010201	133
Q81	3.50376	.831429	133
Q82	3.24812	1.068885	133
Q83	3.39850	.834301	133
Q84	3.66165	.936525	133
Q85	3.42105	.880862	133
Q86	3.48120	.884218	133
Q87	3.42857	.809842	133
Q88	3.39098	.814960	133

Inter-Item Correlation Matrix										
	Q79	Q80	Q81	Q82	Q83	Q84	Q85	Q86	Q87	Q88
Q79	1.000	.404	.452	.512	.303	.385	.469	.480	.368	.422
Q80	.404	1.000	.539	.418	.251	.309	.260	.323	.187	.279
Q81	.452	.539	1.000	.421	.276	.347	.391	.379	.341	.400
Q82	.512	.418	.421	1.000	.381	.304	.307	.426	.340	.427
Q83	.303	.251	.276	.381	1.000	.407	.409	.395	.429	.426
Q84	.385	.309	.347	.304	.407	1.000	.495	.491	.472	.482
Q85	.469	.260	.391	.307	.409	.495	1.000	.526	.542	.444
Q86	.480	.323	.379	.426	.395	.491	.526	1.000	.556	.536
Q87	.368	.187	.341	.340	.429	.472	.542	.556	1.000	.582
Q88	.422	.279	.400	.427	.426	.482	.444	.536	.582	1.000

Item-Total Statistics					
	Scale Mean if Item Deleted	Scale Variance if Item Deleted	Corrected Item-Total Correlation	Squared Multiple Correlation	Cronbach's Alpha if Item Deleted
Q79	30.96992	30.363	.621	.430	.854
Q80	30.86466	31.300	.477	.365	.867
Q81	30.79699	31.602	.580	.413	.858
Q82	31.05263	29.884	.572	.395	.860
Q83	30.90226	32.074	.523	.310	.862
Q84	30.63910	30.702	.591	.392	.857
Q85	30.87970	30.895	.617	.456	.855
Q86	30.81955	30.407	.669	.483	.851
Q87	30.87218	31.506	.610	.493	.856
Q88	30.90977	31.158	.647	.474	.853

Summary Item Statistics							
	Mean	Minimum	Maximum	Range	Maximum /	Variance	N of Items
Item Means	3.430	3.248	3.662	.414	1.127	.012	10
Item Variances	.819	.656	1.143	.487	1.742	.027	10
Inter-Item Correlations	.407	.187	.582	.396	3.121	.008	10

An investigation into the inter-item correlation matrix revealed inter-item correlations that were moderate to substantial in most cases. While the lowest correlates in this regard were found to be Q81 (ranging from .276 to .539) and Q82 (ranging from .304 to .517), the magnitudes of these correlations were not regarded as critically low. Neither of these two items consistently correlated below the mean inter-item correlation with the remaining items of the subscale. Moreover, it was evident after consulting the "Cronbach alpha if deleted" output that the overall scale reliability (.870 Cronbach alpha) would not increase if any one of these items were to be removed from the subscale.

The corrected item-total correlations for the *unites and connects followers* subscale ranged between .477 and .699. No extreme outliers were evident towards the lower end of this distribution. Finally, an inspection of the subscale's squared multiple correlation SPSS output revealed that these values ranged between .310 and .493, demonstrating that there were no extreme outliers towards the lower end of this distribution as well. The results for the inter-item correlations, corrected item-total correlations and squared multiple correlations suggest that all the items responded to the same (but not necessarily unidimensional) systematic source of variance. All evidence therefore supported the verdict of a favourable outcome for the item analysis conducted on this subscale and the researcher decided to retain all items for the consequent dimensionality analysis (CFA) via LISREL.

### 5.5.7.2 Dimensionality analysis

The PRELIS output used for analysing the distributional properties of the *unites and connects followers* subscale is presented in Table 5.65 below.

Table 5.65

#### *PRELIS test of multivariate normality output for the unites and connects followers subscale*

Skewness			Kurtosis			Skewness and Kurtosis	
Value	z-score	p-value	Value	z-score	p-value	Chi-Square	p-value
16.667	5.967	.000	136.679	4.903	.000	56.638	.000

As per Table 5.65, it was again concluded that the null hypothesis that the indicator variable distribution in the parameter follows a multivariate normal distribution had to be rejected (due to a statistically significant skewness and kurtosis chi-squared statistic ( $p < .05$ )). It follows that multivariate normality did not hold and the first-order *unites and connects followers* subscale was subsequently fitted via RML as is shown in Figure 5.9 below. In this case, all initial indications were that the first-order *unites and connects followers* measurement model obtained reasonable fit in the parameter. Reasonable fit was initially concluded as although the null hypothesis of exact fit, measured by the Satorra-Bentler scaled chi-square ( $\chi^2 = 59.28$ ;  $p < .05$ ) had to be rejected, the null hypothesis of close fit, as measured by RMSEA (.072) could not be rejected ( $p > .05$ ). However, the RMSEA value was marginal in terms of (not) confirming reasonable fit (.072), the sample size for the present study was relatively small, and inadequate sample sizes tend to affect the performance of fit indices such as RMSEA (Chen, Curran, Bollen, Kirby, & Paxton, 2008; Kenny, Kaniskan, & McCoach, 2014).<sup>322</sup> Moreover, three of the covariance terms in the observed variance-covariance matrix were significantly ( $p < .01$ ) overestimated (-5.7260, -3.8521 and -2.6564) while one covariance term was significantly ( $p < .01$ ) underestimated (3.5799) by the fitted single-factor measurement model (circa 7%). The researcher consequently decided to err on the side of caution and concluded poor fit for this measurement model in an attempt to immunise the analysis against Type 2 errors.<sup>323</sup>

<sup>322</sup> The full array of fit statistics produced by LISREL 8.8 is shown in Appendix H.

<sup>323</sup> The rest of the fit statistics in Appendix H also provide a somewhat ambivalent verdict on the fit of the model with, for example the CFI suggesting good fit and the SRMSR indicating reasonable to poor fit.

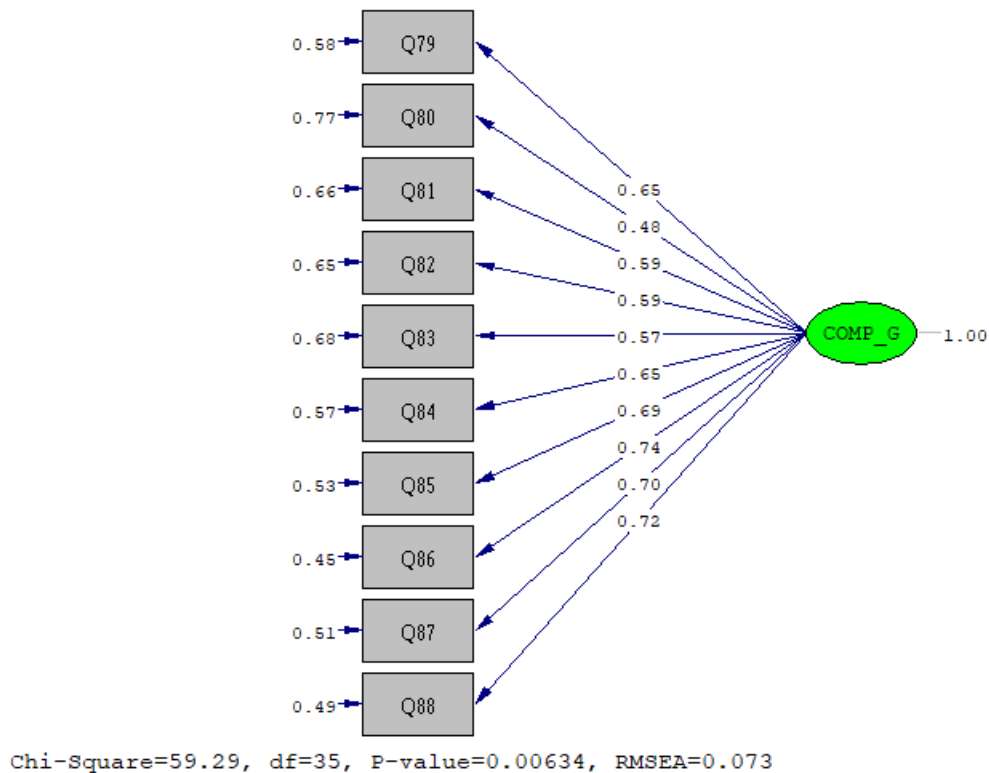

Figure 5.9. First-order single-factor *unites and connects followers* measurement model (completely standardised solution)

Consequently, the researcher reverted to an exploratory factor analysis in order to further scrutinise the subscale's underlying factor structure and confirm whether the extreme caution taken to not make an incorrect conclusion on the measurement model fit was warranted. For this purpose, the researcher again utilised the principle axis factor method with oblimin rotation via SPSS, after which another two-factor solution emerged within 5 iterations based on the Kaiser criterion. Only 13% of the residual correlations were larger than .05 indicating that the two-factor structure offered a valid and credible explanation of the observed inter-item correlation matrix. The pattern matrix that emerged is presented in Table 5.66 below.

Table 5.66

*EFA pattern matrix for the unites and connects followers subscale*

	Pattern Matrix	
	Factor	
	1	2
Q87	<b>.876</b>	-.174
Q88	<b>.685</b>	.064
Q85	<b>.678</b>	.036
Q86	<b>.672</b>	.105
Q84	<b>.615</b>	.069
Q83	<b>.535</b>	.063
Q80	-.116	<b>.800</b>
Q81	.123	<b>.625</b>
Q82	.230	<b>.483</b>
Q79	.313	<b>.448</b>

Note: Bold factor loadings indicate the factor predominantly reflected by each item. Factor loadings are partial regression coefficients reflecting the influence of each factor on each item when controlling for the other factor. The latter is important because the factors to some degree share common variance due to the correlation between factors.

The pattern matrix clearly revealed the existence of a two-factor structure underlying this subscale, which vindicated the researcher's conservativeness in not prematurely accepting model fit (without further investigation). According to the pattern mix, Q83 to Q87 loaded (magnitudes ranged between .535 and .876) onto factor 1, and Q79-Q82 loaded (magnitudes ranged between .448 and .800) onto factor 2. Upon closer inspection it was evident that factor 1 (e.g. themes relating to resolving differences, facilitating personal information sharing, facilitating work-life sharing, facilitating open debates) could be interpreted as the graduate's competence in facilitating understanding and the sharing of information amongst members of their unit (or team), while factor 2 (e.g. themes relating to strong relationships, a sense of belonging, trust and cooperation, synergy, etc.) could be interpreted as the graduate leader's competence in forging strong, productive bonds between members of their unit (or team). It could be argued that factor 1 represents competence in facilitating conditions necessary for successfully forging bonds between members of the unit. The factor fission was therefore considered conceptually meaningful, in that both of these two "themes" represent logical facets of the *unites and connects followers* (second-order)<sup>324</sup> competency that the subscale was designed to measure. The number of items that loaded on factor 2 gave credence to the factor. The two extracted factors correlated moderately positively (.596) in the obliquely rotated solution. Moreover, it was argued that the conceptual distinction between the preparatory and core interpretations of *unites and connects followers* will be of value in providing formative feedback to graduate leaders during their leadership development programme. Thus, the researcher still considered the operationalisation of this construct to be 'successful' pending the outcome of a CFA on the suggested two-factor solution, even if this competency was not operationalised in exactly the same manner in Chapter 2. The decision was therefore taken not to delete some of the items that loaded on factor 2 in an attempt to achieve unidimensionality in the subscale. Achieving unidimensionality through the deletion of items would shrink the connotative meaning of the *unites and connects followers* competency to the detriment of the intended use of the PGLCQ.

The evaluation of fit for the two-factor measurement model as suggested in the SPSS pattern matrix and as is presented in Figure 5.10 below in the subsequent CFA proved to be extremely favourable. The Satorra-Bentler scaled chi-square statistic delivered a statistically insignificant value ( $\chi^2 = 26.34$ ;  $p > .05$ ), meaning that the exact fit null hypothesis could not be rejected. This implied that the two-factor measurement model was able to reproduce the observed covariance matrix to a degree of accuracy that could be explained in terms of sampling error alone. In line with expectations, the close fit null hypothesis (RMSEA = .0;  $p > .05$ ) could likewise not be rejected. In the case where the close fit null hypothesis was not rejected, it must be noted that the sample RMSEA estimate improved considerably when fitting the two-factor measurement model (i.e. from RMSEA = .072 to RMSEA = .000), which gave the researcher more confidence in this finding than was the case earlier. Moreover, an investigation into the two-factor measurement model's standardised residuals output revealed that only one observed covariance value was significantly ( $p < .01$ ) overestimated ( $\leq -2.58$ ) (-3.548) out of the 55 variances and covariances observed in the covariance matrix (2%). The fitted (two-factor) measurement model therefore succeeded in accurately reproducing 98% of the unique variance and covariances in the observed covariance matrix, which commented very favourably on its fit in the parameter.

---

<sup>324</sup> In fact, the name of the competency is suggestive of these 2 factors.

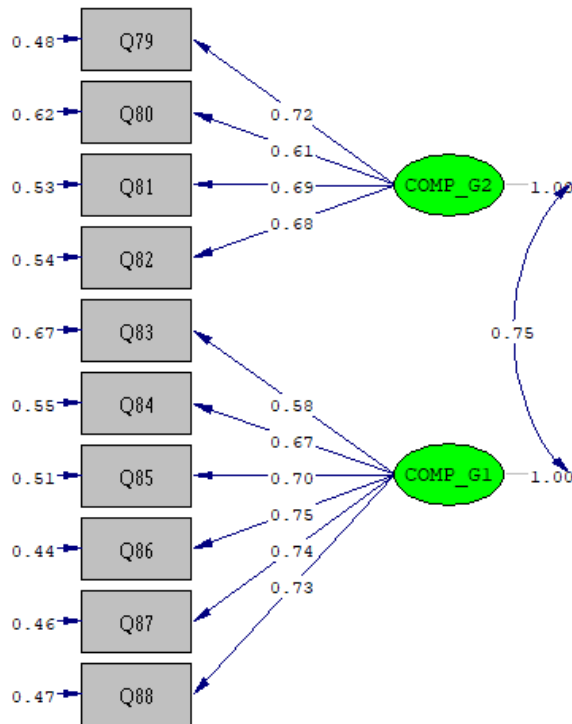

Chi-Square=26.34, df=34, P-value=0.82321, RMSEA=0.000

Figure 5.10. First-order two-factor *unites and connects followers* measurement model (completely standardised solution)

The unstandardised factor loading matrix ( $\Lambda^X$ ) for the two-factor *unites and connects followers'* measurement model is shown in Table 5.67.

Table 5.67

Unstandardised factor loading matrix ( $\Lambda^X$ ) for the two-factor *unites and connects followers* measurement model

Item	COMP_G1	COMP_G2
Q79	--	0.6777* (0.0887) 7.6360
Q80	--	0.6203* (0.0828) 7.4899
Q81	--	0.5702* (0.0735) 7.7564
Q82	--	0.7231* (0.0844) 8.5682
Q83	0.4819* (0.0667) 7.2261	--
Q84	0.6258* (0.0675) 9.2682	--
Q85	0.6162* (0.0705) 8.7451	--
Q86	0.6608* (0.0651) 10.1572	--

Table 5.67

*Unstandardised factor loading matrix ( $\Lambda^x$ ) for the two-factor unites and connects followers measurement model (continued)*

Item	COMP_G1	COMP_G2
Q87	0.5978* (0.0591) 10.1109	--
Q88	0.5928* (0.0637) 9.3035	--

Note: the first row in each cell in columns 2 and 3 of Table 5.67 represents the unstandardised factor loading estimate ( $\lambda_{ij}$ ), row two (in brackets) represents the standard error and the third row represents the unstandardised estimate transformed to a z-score obtained by dividing the unstandardised estimate by its standard error.

\*p < .05

Table 5.67 shows that all the items of the *unites and connects followers* subscale statistically significantly ( $p < .05$ ) reflect the factor that they were designated to represent according to the pattern matrix (Table 5.66) obtained from the EFA. The null hypotheses that  $\lambda_{ij} = 0$  in the parameter could therefore be rejected for all items. The completely standardised factor loading matrix ( $\Lambda^x$ ) for the two-factor *unites and connects followers* measurement model is shown in Table 5.68.

Table 5.68

*Completely standardised factor loading matrix ( $\Lambda^x$ ) for the two-factor unites and connects followers measurement model*

	COMP_G1	COMP_G2
Q79	--	.7185
Q80	--	.6141
Q81	--	.6858
Q82	--	.6765
Q83	.5776	--
Q84	.6682	--
Q85	.6995	--
Q86	.7473	--
Q87	.7381	--
Q88	.7274	--

Table 5.68 shows that all items of the subscale load satisfactorily on the factor that they were designated to reflect. The unstandardised measurement error variance matrix for the two-factor *unites and connects followers* measurement model is shown in Table 5.69 and the completely standardised measurement error variance matrix in Table 5.70.

Table 5.69

*Unstandardised measurement error variance matrix ( $\Theta_{\delta}$ ) for the two-factor unites and connects followers measurement model*

Q79	Q80	Q81	Q82	Q83	Q84
0.4305* (0.0692)	0.6357* (0.0977)	0.3661* (0.0531)	0.6197* (0.0899)	0.4638* (0.0548)	0.4854* (0.0735)
6.2203	6.5049	6.8917	6.8964	8.4644	6.6050
Q85	Q86	Q87	Q88		
0.3963* (0.0512)	0.3452* (0.0619)	0.298*5 (0.0475)	0.3127* (0.0554)		
7.7378	5.5815	6.2898	5.6423		

Note: the first row in each cell in each column of Table 5.69 represents the unstandardised measurement error variance estimate ( $\theta_{\delta ii}$ ), row two (in brackets) represents the standard error and the third row represents the unstandardised estimate transformed to a z-score obtained by dividing the unstandardised estimate by its standard error. \*p < .05

Table 5.70

*Completely standardised measurement error variance matrix ( $\Theta_{\delta}$ ) for the two-factor unites and connects followers measurement model*

Q79	Q80	Q81	Q82	Q83	Q84
.4838	.6229	.5296	.5424	.6663	.5535
Q85	Q86	Q87	Q88		
.5107	.4416	.4551	.4709		

The unstandardised theta-delta matrix (Table 5.69) for this two-factor *unites and connects followers* measurement model indicates that all the items of the *unites and connects followers* subscale were statistically significantly ( $p < .05$ ) plagued by systematic and random measurement error. The completely standardised theta-delta matrix for this two-factor measurement model, in turn, revealed measurement error variances for all items that gravitated towards .500. In general, it was thus concluded that measurement error variances accounted for approximately only up to 50% of the variance in the subscale's items.

In addition, the  $R^2$  values for the two-factor *unites and connects followers* measurement model (see Table 5.71 below) indicated values that ranged between .446 and .558 for the majority of items (except for Q83 with a value of .333 and Q80 with a value of .377), signifying that between 45% and 56% of the variance in the majority of the items was explained by the two-factor latent construct underlying this subscale that the items were intended<sup>325</sup> to reflect. Hence, given the findings of exact fit, statistically significant ( $p < .05$ ) factor loadings, a low percentage of standardised residuals, the existence of relatively low measurement error variance and moderate to strong magnitudes for the respective  $R^2$  values, the researcher concluded that the fitted two-factor measurement model constituted a valid (and credible) multidimensional (two-factor) explanation of the *unites and connects followers* inter-item covariance matrix.

Table 5.71

*$R^2$  values for the two-factor unites and connects followers measurement model*

Q79	Q80	Q81	Q82	Q83
.516	.377	.470	.457	.333
Q84	Q85	Q86	Q87	Q88
.446	.489	.558	.544	.529

The factor fission of the *unites and connects followers* subscale was regarded as conceptually and practically meaningful. The items of the current subscale provided psychometrically acceptable measures of the two extracted factors. However, the two sets of items comprising the current scale would have to be extended to provide separate measures of the two *unites and connects followers* facets with acceptable reliabilities. That leaves the question, in the interim, and beyond, whether the items may also be regarded as statistically significant ( $p < .05$ ) indicators of a second-order *unites and connects followers* competency.

To attempt to answer this question a second-order *unites and connects followers* measurement model was fitted with a single second-order *unites and connects followers* factor.<sup>326</sup> The excellent fit of the two-factor first-order *unites and connects followers* measurement model shown in Figure 5.10, combined with the moderate inter-factor correlation, justified the fitting of the second-order model. The completely standardised solution for the fitted two-factor second-order *unites and connects followers* measurement model is shown in Figure 5.11.

<sup>325</sup> Once again, although the researcher used a variety of first-order competencies in order to "conceive" the second-order competency of unites and connects followers, this second-order competency was initially operationalised as a single-factor latent construct in Chapter 2. The fact that the word "intended" used here is therefore strictly speaking incorrect.

<sup>326</sup> Diagonally weighted least squares estimation was used rather than robust maximum likelihood estimation.



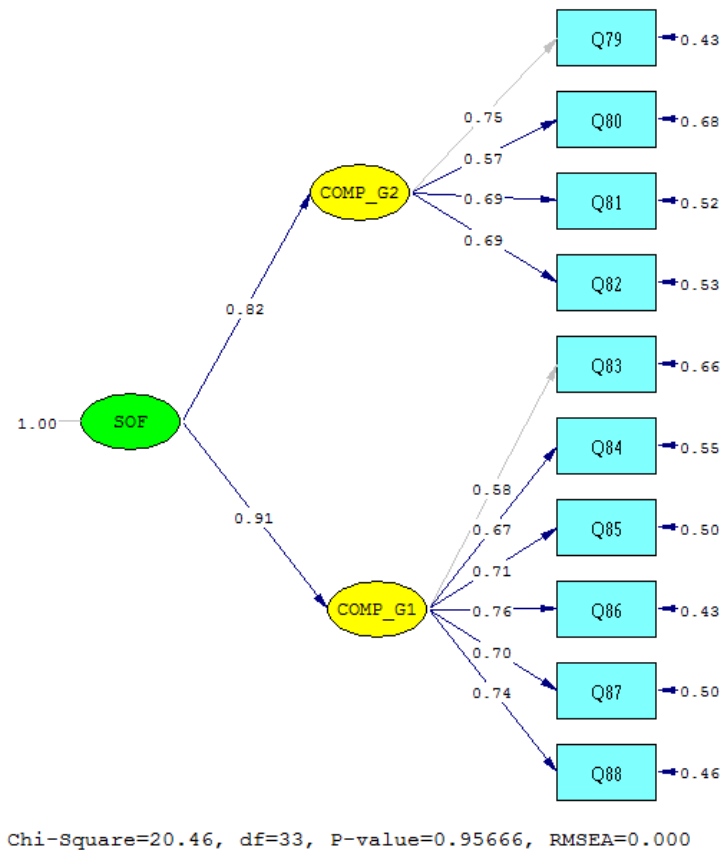

Figure 5.11. Second-order two-factor *unites and connects followers* measurement model (completely standardised solution)

The Satorra-Bentler scaled chi-square returned a statistically insignificant estimate (20.4620;  $p > .05$ ). The exact fit null hypothesis ( $H_{0i}$ : RMSEA = 0) needed therefore not to be rejected. The observed sample RMSEA estimate (.000) could therefore be fully explained in terms of sampling error. It therefore followed that the close fit null hypothesis ( $H_{0i}$ : RMSEA  $\leq .05$ ) also needed not to be rejected. The probability of observing the sample RMSEA estimate (.000) under both the exact fit and close fit null hypotheses were therefore sufficiently large not to question either hypothesis.<sup>327</sup> Only two (circa 3.6%) statistically significant ( $p < .01$ ) standardised covariance residuals were observed (-5.6086 and 4.0445). The excellent fit obtained for the second-order two-factor *unites and connects followers* measurement model justified the calculation of the indirect effects of the second-order factor on the *unites and connects followers* subscale items, and the testing of their statistical significance.

For this purpose, the SIMPLIS syntax used to fit the second-order two- *unites and connects followers* measurement model was translated to LISREL syntax. This allowed the use of the LISREL syntax command AP on the model command line to specify the creation of 10 additional parameters (i.e., the indirect effects) and the CO command to specify the ten indirect effects to be calculated.<sup>328</sup> The unstandardised indirect effects are shown in Table 5.72.

<sup>327</sup> The full array of fit statistics produced by LISREL 8.8 is shown in Appendix H.

<sup>328</sup> CO PAR1 = LY(1,2)\*GA(1,2)  
 CO PAR2 = LY(2,2)\*GA(1,2)  
 CO PAR3 = LY(3,2)\*GA(1,2)  
 CO PAR4 = LY(4,2)\*GA(1,2)  
 CO PAR5 = LY(5,1)\*GA(1,1)

Table 5.72

*Unstandardised indirect effects of the second-order factor on the unites and connects followers subscale items*

PA(1)	PA(2)	PA(3)	PA(4)	PA(5)	PA(6)
.58*	.47*	.47*	.60*	.44*	.57*
(0.09)	(0.09)	(0.09)	(0.09)	(0.09)	(0.09)
6.68	5.40	5.40	6.89	5.08	6.57
PA(7)*	PA(8)*	PA(9)*	PA(10)*		
.57	.61	.52	.54		
(0.09)	(0.09)	(0.09)	(0.09)		
6.50	6.97	5.96	6.26		

Note: the first row in each cell in each column of Table 5.72 represents the unstandardised indirect effect estimate PA<sub>i</sub> row two (in brackets) represents the standard error and the third row represents the unstandardised estimate transformed to a z-score obtained by dividing the unstandardised estimate by its standard error.

\*p < .05

The statistical significance of the indirect effects presented in Table 5.72 above implies that the *unites and connects followers* subscale items, despite measuring two distinct factors, could therefore still be regarded as composite indicators of a higher-order (broader) *unites and connects others* competency. It follows that the different items measuring factor 1 and factor 2 of this subscale accordingly had to be treated as subtests of the same higher-order *unites and connects followers competency* – i.e. they were acknowledged to measure two different strata of the same latent (higher-order) construct and not two separate measures of two unrelated constructs. More importantly, in the interim, before the expansion of the *unites and connects followers* subscale to provide psychometrically adequate measures of the two *unites and connects followers* facets, the subscale items can be used as indicators of the higher-order *unites and connects followers* factor.

In view of this, the researcher again utilised the Stratified alpha Excel macro to calculate the more appropriate reliability coefficient for this subscale. The value (.884) returned was once again satisfactory (>.80) and marginally more favourable than the Cronbach alpha value (.870) that was presented as part of the item analysis output for this subscale in Table 5.64. The Cronbach alphas calculated for the items loading on the two facets were .767 (factor 2) and .846 (factor 1).

## 5.5.8 PSYCHOMETRIC EVALUATION OF THE 'STRENGTHENS AND ENABLES FOLLOWERS' SUBSCALE

### 5.5.8.1 Item analysis

The *strengthens and enables followers* subscale intended to measure the extent to which a graduate leader raises the confidence and performance capabilities of followers towards success and high levels of achievement. As was the case with the *creates an exciting and aspirational vision for the unit* and the *involves others and elicits participation* subscales, the researcher was particularly pleased with the results of the item analysis for this subscale. As per Table 5.73 below, item means for this subscale ranged from 3.135 to 3.789 on a 5-point scale, while the item standard deviations ranged from .836 to .980. This means that participants typically rated their performance (or that of their subordinate) as satisfactory at above the midpoint (i.e. 3.1 to 3.8) while responses in general were again relatively spread out around these means. On the face of this evidence of no extreme or truncated means nor the presence of small standard deviations, it was once again concluded that the *strengthens and enables followers* subscale was able to

$$\text{CO PAR6} = \text{LY}(6,1) * \text{GA}(1,1)$$

$$\text{CO PAR7} = \text{LY}(7,1) * \text{GA}(1,1)$$

$$\text{CO PAR8} = \text{LY}(8,1) * \text{GA}(1,1)$$

$$\text{CO PAR9} = \text{LY}(9,1) * \text{GA}(1,1)$$

$$\text{CO PAR10} = \text{LY}(10,1) * \text{GA}(1,1)$$

sufficiently discriminate between participant responses in measuring the latent construct underlying it.

Table 5.73

*Item analysis output for the strengthens and enables followers subscale*

Reliability Statistics	
Cronbach's Alpha	N of Items
.904	10

Item Statistics			
	Mean	Std. Deviation	N
Q90	3.50376	.974089	133
Q91	3.67669	.933784	133
Q92	3.78947	.896564	133
Q93	3.46617	.965691	133
Q94	3.55639	.916296	133
Q95	3.35338	.836619	133
Q96	3.45865	.883444	133
Q97	3.44361	.980210	133
Q98	3.13534	.975316	133
Q99	3.51880	.901190	133

Inter-Item Correlation Matrix										
	Q90	Q91	Q92	Q93	Q94	Q95	Q96	Q97	Q98	Q99
Q90	1.000	.614	.478	.562	.498	.449	.522	.470	.478	.563
Q91	.614	1.000	.470	.572	.584	.593	.429	.489	.498	.534
Q92	.478	.470	1.000	.490	.356	.403	.372	.331	.379	.436
Q93	.562	.572	.490	1.000	.552	.498	.520	.316	.512	.556
Q94	.498	.584	.356	.552	1.000	.601	.468	.474	.500	.529
Q95	.449	.593	.403	.498	.601	1.000	.404	.436	.582	.539
Q96	.522	.429	.372	.520	.468	.404	1.000	.498	.349	.498
Q97	.470	.489	.331	.316	.474	.436	.498	1.000	.365	.501
Q98	.478	.498	.379	.512	.500	.582	.349	.365	1.000	.600
Q99	.563	.534	.436	.556	.529	.539	.498	.501	.600	1.000

Item-Total Statistics						
	Scale Mean if Item Deleted	Scale Variance if Item Deleted	Corrected Item-Total Correlation	Squared Multiple Correlation	Cronbach's Alpha if Item Deleted	
Q90	31.39850	36.848	.704	.529	.891	
Q91	31.22556	36.979	.728	.567	.890	
Q92	31.11278	39.116	.553	.337	.901	
Q93	31.43609	37.051	.692	.544	.892	
Q94	31.34586	37.531	.690	.516	.892	
Q95	31.54887	38.356	.682	.526	.893	
Q96	31.44361	38.643	.610	.436	.897	
Q97	31.45865	38.174	.577	.420	.900	
Q98	31.76692	37.529	.639	.483	.896	
Q99	31.38346	37.329	.724	.547	.890	

Summary Item Statistics							
	Mean	Minimum	Maximum	Range	Maximum /	Variance	N of Items
Item Means	3.490	3.135	3.789	.654	1.209	.031	10
Item Variances	.860	.700	.961	.261	1.373	.008	10
Inter-Item Correlations	.486	.316	.614	.297	1.941	.006	10

Inter-item correlations for this subscale were, moreover, regarded as being close to perfect (most values ranged from .400 upwards to no more than .614) with an inter-item correlation mean of .486. None of the items consistently correlated below the mean inter-item correlation with the remaining items of the subscale. In addition, the initial Cronbach alpha coefficient for the subscale was .904, and it was apparent that the removal of any items would not improve, but rather detract from the reliability of this subscale. It was furthermore apparent that the corrected item-total correlations for all of the items in the subscale proved to be favourable as all values ranged from .553 to .724. No outliers were evident towards the lower end of this distribution. Finally, an investigation of the squared multiple correlations for this subscale also yielded positive findings.

Squared multiple correlations ranged from .420 to .547 and no outliers were evident towards the lower end of this distribution.

### 5.5.8.2 Dimensionality analysis

The PRELIS output used for analysing the distributional properties of the *strengthens and enables followers* subscale is presented in Table 5.74 below.

Table 5.74

*PRELIS test of multivariate normality output for the strengthens and enables followers subscale*

Skewness			Kurtosis			Skewness and Kurtosis	
Value	z-score	p-value	Value	z-score	p-value	Chi-Square	p-value
13.965	3.826	.000	135.235	4.627	.000	36.050	.000

As was the case with all of the subscales investigated thus far, it was again clear that the null hypothesis that the indicator variable distribution in the parameter follows a multivariate normal distribution had to be rejected (due to a statistically significant skewness and kurtosis chi-squared statistic  $p < .05$ ). Hence, the assumption of multivariate normality did not hold and the first-order *strengthens and enables followers* measurement model was also fitted via RML as is shown in Figure 5.12 below.

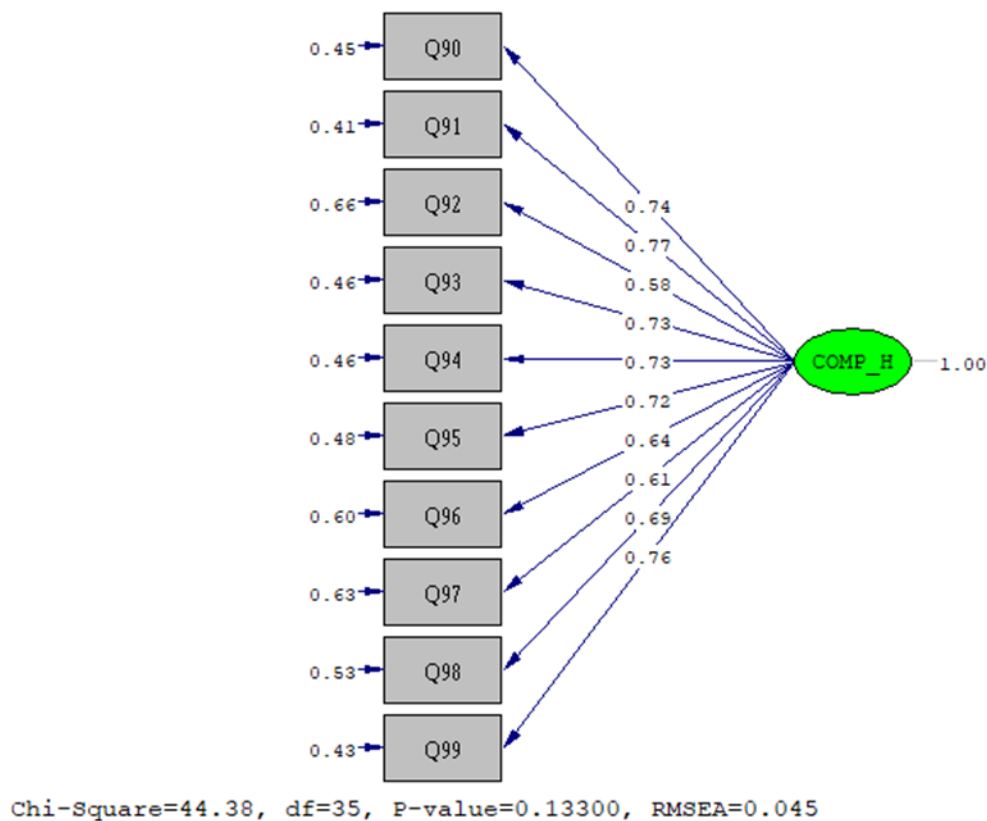

Figure 5.12. First-order *strengthens and enables followers* measurement model (completely standardised solution)

In this case, the first-order *strengthens and enables followers* measurement model also obtained excellent fit in the parameter. This conclusion was made as the Satorra-Bentler chi-squared statistic delivered a statistically insignificant value ( $\chi^2 = 44.38$ ;  $p > .05$ ), meaning that the exact fit null hypothesis ( $H_{01}$ : RMSEA = 0) could not be rejected. Similarly, the null hypothesis of close ( $H_{02}$ :

RMSEA  $\leq$  0) fit could also not be rejected (RMSEA = 0.045;  $p > .05$ )<sup>329</sup>. The standardised residuals output revealed that the measurement model did not statistically significantly ( $p < .05$ ) overestimate or underestimate any of the 55 variances and covariances observed in the covariance matrix and a near perfect symmetrical dispersion around zero on the stem-and-leaf plot distribution. These findings in totality commented extremely favourably on the fit of the *strengthens and enables followers* measurement model. The good fit of the *strengthens and enables followers* measurement model in turn corroborated the unidimensionality assumption for the *strengthens and enables followers* subscale. It moreover warranted the interpretation of the statistical significance and magnitude of the measurement model parameter estimates.

The unstandardised factor loading matrix ( $\Lambda^x$ ) is shown in Table 5.75.

Table 5.75

*Unstandardised factor loading matrix ( $\Lambda^x$ ) for the strengthens and enables followers measurement model*

Item	COMP_H
Q90	0.7195* (0.0770) 9.3448
Q91	0.7202* (0.0671) 10.7285
Q92	0.5239* (0.0662) 7.9121
Q93	0.7097* (0.0773) 9.1784
Q94	0.6724* (0.0702) 9.5716
Q95	0.6052* (0.0751) 8.0613
Q96	0.5611* (0.0772) 7.2682
Q97	0.5961* (0.0932) 6.3939
Q98	0.6702* (0.0745) 8.9995
Q99	0.6833* (0.0718) 9.5218

Note: the first row in each cell in column 2 of Table 5.75 represents the unstandardised factor loading estimate ( $\lambda_{ij}$ ), row two (in brackets) represents the standard error and the third row represents the unstandardised estimate transformed to a z-score obtained by dividing the unstandardised estimate by its standard error.

\* $p < .05$

Table 5.75 shows that all the subscale items statistically significantly ( $p < .05$ ) loaded on the latent *strengthens and enables followers* graduate leader competency. All ten of the null hypotheses  $H_{0j}$ :  $\lambda_{ij} = 0$  could therefore be rejected. The factor loading estimates could therefore all be generalised as point estimates to the parameter.

The completely standardised factor loading matrix ( $\Lambda^x$ ) for the *strengthens and enables followers* subscale is shown in Table 5.76.

<sup>329</sup> The full array of fit statistics produced by LISREL 8.8 is shown in Appendix H.

Table 5.76

*Completely standardised factor loading matrix ( $\Lambda^x$ ) for the strengthens and enables followers measurement model*

Item	COMP_H
Q90	.7386
Q91	.7713
Q92	.5843
Q93	.7349
Q94	.7338
Q95	.7233
Q96	.6351
Q97	.6081
Q98	.6872
Q99	.7582

Table 5.76 indicates that the completely standardised factor loadings for all ten items of the *strengthens and enables followers* subscale exceeded the critical cut-off value of .50. Moreover, the completely standardised loadings were for the most part reasonably large in magnitude. This implies that the latent graduate leadership *strengthens and enables followers* competency explains reasonable proportions of variance in each item that generally quite comfortably surpasses the critical cut-off of 25%.

The unstandardised measurement error variance matrix for the *strengthens and enables followers* subscale is shown in Table 5.77 and the completely standardised measurement error variance matrix in Table 5.78.

Table 5.77

*Unstandardised measurement error variance matrix ( $\Theta_{\delta}$ ) for strengthens and enables followers measurement model*

Q90	Q91	Q92	Q93	Q94	Q95
0.4312*	0.3533*	0.5294*	0.4289*	0.3875*	0.3337*
(0.0518)	(0.0533)	(0.0725)	(0.0649)	(0.0558)	(0.0529)
8.3187	6.6232	7.2990	6.6080	6.9451	6.3058
Q96	Q97	Q98	Q99		
0.4657*	0.6055*	0.5020*	0.3453*		
(0.0599)	(0.0845)	(0.0745)	(0.0565)		
7.7696	7.1628	6.7408	6.1111		

Note: the first row in each cell in each column of Table 5.77 represents the unstandardised measurement error variance estimate ( $\theta_{\delta ii}$ ), row two (in brackets) represents the standard error and the third row represents the unstandardised estimate transformed to a z-score obtained by dividing the unstandardised estimate by its standard error.

\* $p < .05$

Table 5.78

*Completely standardised measurement error variance matrix ( $\Theta_{\delta}$ ) for the strengthens and enables followers measurement model*

Q90	Q91	Q92	Q93	Q94	Q95
.4544	.4052	.6586	.4599	.4615	.4768
Q96	Q97	Q98	Q99		
.5966	.6302	.5278	.4251		

An inspection of the unstandardised theta-delta matrix (Table 5.77) for the *strengthens and enables followers* measurement model revealed that all the items of this subscale were statistically significantly ( $p < .05$ ) affected by systematic and random measurement error. The completely standardised theta-delta matrix for this measurement model (Table 5.78), in turn, revealed that the completely standardised estimates for the measurement error variances ranged between .405 and .658. For the majority of the subscale items, however, the values calculated here gravitated between .425 and .476. In practical terms this meant that for the majority of cases, extraneous

variance accounted for between 43% and 48% of the variance in the subscale's items. It is acknowledged however, that items Q93, Q96 and Q97 were more aggressively plagued by extraneous variance than the rest of the subscale's items (e.g. up to 66% in the case of Q92). The amount of variance accounted for in the subscale's items by the latent factor underlying the subscale, on the other hand, is presented in Table 5.79 below.

Table. 5.79

*R<sup>2</sup> values for the strengthens and enables followers measurement model*

Q90	Q91	Q92	Q93	Q94
.545	.594	.341	.541	.538
Q95	Q96	Q97	Q98	Q99
.523	.403	.369	.472	.574

The magnitude of the respective  $R^2$  values obtained for the items in this subscale were found to range between .472 and .594, except for Q92 (at .341), Q96 (at .403) and Q97 (at .369). In practical terms, this meant that the factor underlying this subscale accounted for between 48% and 59% of the variance in the majority of the subscale's items. The fact that the majority of the items seemed to be successfully tapping into the factor underlying this subscale and the evidence in favour of measurement model fit (i.e. exact fit and no statistically significant ( $p < .01$ ) standardised covariance residuals) coupled with findings that all the items statistically significantly ( $p < .05$ ) loaded on the single factor and the majority of the subscale's items were relatively free from the influence of extraneous measurement variance prompted the researcher to support the claim that this subscale reasonably successfully operationalised the latent graduate leadership *strengthens and enables followers* competency.

As per the methodology followed up until now, the researcher proceeded to calculate the reliability coefficient for this subscale. In this regard, JASP calculated the (more theoretically correct) McDonald's omega coefficient at .905, while the Cronbach alpha coefficient included in the item analysis output via SPSS (Table 5.73) returned a value of .904. As interpreted by way of generally accepted reliability cut-off guidelines (Clark & Watson, 1995; Nunnally & Bernstein, 1994), this result ( $\omega > .900$ ) was indicative of an excellent level of reliability and more specifically, it implied that approximately 91% of the variance in the subscale items occurred because of systematic sources of variance, and that approximately less than 9% of the variance occurred due to random error.

## 5.5.9 PSYCHOMETRIC EVALUATION OF THE 'MANAGES THE INTERNAL WORK UNIT ENVIRONMENT' SUBSCALE

### 5.5.9.1 Item analysis

The *manages the internal work unit environment* subscale intended to measure the extent to which a graduate leader maintains a hands-off procedural view and executes in-process corrections as and when required to ensure that different components of the conversion process keep pulling in the same direction. Table 5.80 below presents the results of the item analysis for the ninth (and final) PGLCQ subscale. As per Table 5.80, item means for this subscale ranged from 3.300 to 3.693 on a 5-point scale while the item standard deviations ranged between .807 and .948. This meant that for this subscale, participants typically responded at above the midpoint (i.e. 3.5 out of 5) while responses in general was relatively spread out around this area. The lack of extreme, curtailed means as well as the absence of small item standard deviations led the researcher to conclude that the *manages the internal work unit environment* subscale was able to sufficiently discriminate between participant responses in measuring the latent construct underlying it.

Table 5.80

*Item analysis output for the manages the internal work unit environment subscale*

Reliability statistics	
Cronbach's Alpha	N of Items
.913	10

Item Statistics			
	Mean	Std. Deviation	N
Q101	3.34586	.879438	133
Q102	3.30827	.818169	133
Q103	3.35338	.914492	133
Q104	3.42857	.837436	133
Q105	3.63158	.830057	133
Q106	3.51880	.849256	133
Q107	3.54887	.820810	133
	Mean	Std. Deviation	N
Q108	3.30075	.807024	133
Q109	3.37594	.831223	133
Q110	3.63910	.948191	133

Inter-Item Correlation Matrix										
	Q101	Q102	Q103	Q104	Q105	Q106	Q107	Q108	Q109	Q110
Q101	1.000	.619	.535	.476	.466	.498	.491	.557	.463	.314
Q102	.619	1.000	.653	.480	.514	.466	.457	.593	.519	.379
Q103	.535	.653	1.000	.543	.522	.464	.466	.481	.522	.340
Q104	.476	.480	.543	1.000	.621	.452	.482	.480	.616	.473
Q105	.466	.514	.522	.621	1.000	.649	.644	.596	.620	.417
Q106	.498	.466	.464	.452	.649	1.000	.621	.533	.591	.422
Q107	.491	.457	.466	.482	.644	.621	1.000	.595	.584	.510
Q108	.557	.593	.481	.480	.596	.533	.595	1.000	.598	.420
Q109	.463	.519	.522	.616	.620	.591	.584	.598	1.000	.539
Q110	.314	.379	.340	.473	.417	.422	.510	.420	.539	1.000

Item-Total Statistics					
	Scale Mean if Item Deleted	Scale Variance if Item Deleted	Corrected Item-Total Correlation	Squared Multiple Correlation	Cronbach's Alpha if Item Deleted
Q101	31.10526	33.656	.645	.495	.907
Q102	31.14286	33.775	.690	.580	.904
Q103	31.09774	33.195	.662	.522	.906
Q104	31.02256	33.689	.681	.534	.904
Q105	30.81955	33.179	.747	.627	.901
Q106	30.93233	33.503	.690	.542	.904
Q107	30.90226	33.528	.716	.569	.902
Q108	31.15038	33.659	.715	.552	.903
Q109	31.07519	33.146	.749	.592	.900
Q110	30.81203	34.033	.549	.378	.913

Summary Item Statistics							
	Mean	Minimum	Maximum	Range	Maximum /	Variance	N of Items
Item Means	3.445	3.301	3.639	.338	1.103	.017	10
Item Variances	.731	.651	.899	.248	1.380	.007	10
Inter-Item Correlations	.517	.314	.653	.339	2.078	.007	10

Inter-item correlations were furthermore regarded as satisfactory (values ranged from .314 to .620), suggesting a moderate to substantial degree of internal consistency for the subscale item set. The mean inter-item correlation was moreover reported as .517, which was the second highest out of all of the PGLCQ subscales. None of the items consistently correlated lower than the mean inter-item correlation with the remaining items of the subscale. Item Q110, but for its correlation with Q109, would have been flagged as an item that met this criterion. In addition, from the SPSS output it was also evident that the Cronbach alpha coefficient would not improve if any of the items were to be removed from this subscale. As can be seen in Table 5.80, it was furthermore apparent that the corrected item-total correlations for all of the items in the subscale proved to be favourable (values ranged from .553 to .724). No extreme outliers were evident



towards the lower end of this distribution. This suggested uniformity in terms of the degree to which differences among participants' responses to the subscale's individual items were consistent with their responses to the *manages the internal work unit environment* subscale as a whole. The squared multiple correlations for this subscale, on the other hand, ranged between .378 and .627, and no extreme outliers were evident towards the lower end of this distribution. Item Q110 could possibly have been flagged as approaching outlier status. Given the evidence in support of a homogeneously performing item set, the researcher retained all of the items for the ensuing dimensionality analysis of this subscale.

### 5.5.9.2 Dimensionality analysis

Upon testing the distributional properties of this subscale (see Table 5.81 below), it became apparent that the null hypothesis that the indicator variable distribution in the parameter follows a multivariate normal distribution also had to be rejected (due to a statistically significant skewness and kurtosis chi-square statistic;  $p < .05$ ). Thus, ultimately the assumption that the researcher was dealing with multivariate normal data for all of the PGCLQ subscales did not hold, echoing the thoughts of Barnes et al. (2001, p. 80) who suggest, "variables are rarely normally distributed... Probably in strict terms the question is a non-issue from the beginning: virtually no variable follows the normal distribution".

Table 5.81

*PRELIS test of multivariate normality output for the manages the internal work unit environment subscale*

Skewness			Kurtosis			Skewness and Kurtosis	
Value	z-score	p-value	Value	z-score	p-value	Chi-Square	p-value
11.310	1.433	.152	131.958	3.955	.000	17.691	.000

Thus, the *manages the internal work unit environment* subscale was also fitted via RML as shown in Figure 5.13 below. The *manages the internal work unit environment* subscale was the second of the PGLCQ's subscales for which LISREL abjectly proposed poor fit in the parameter right from the start. Poor fit had to be concluded as the null hypothesis of exact fit, tested by the Satorra-Bentler chi-square ( $\chi^2 = 71.80$ ;  $p < .05$ ), and close fit, as tested by the RMSEA exceedance probability (.089;  $p < .05$ ) both had to be rejected. As it was not even permissible to conclude close fit, the researcher again had to revert to an exploratory factor analysis in order to further scrutinise the subscale's underlying factor structure for more clarification. The SPSS principle axis method with oblimin rotation was again utilised for this purpose. In this regard, SPSS initially reported that it was unnecessary to extract another factor based on the eigenvalue-greater-than-1 rule and that only one factor was necessary to account for the observed correlation matrix. However, from the percentage of large residual correlations (46%) in the SPSS output it was evident that a one-factor factor structure did not provide a substantially convincing explanation for the observed correlation matrix. Consequently, the researcher requested SPSS to extract a second factor, after which a two-factor solution was produced that converged within 6 iterations. This pattern matrix is presented in Table 5.82 below.

Table 5.82

*EFA Pattern matrix for the manages the internal work unit environment subscale*  
 Pattern Matrix

	Factor	
	1	2
Q107	<b>.828</b>	-.054
Q105	<b>.778</b>	.040
Q109	<b>.766</b>	.047
Q106	<b>.725</b>	.027
Q110	<b>.661</b>	-.070
Q104	<b>.557</b>	.187
Q108	<b>.489</b>	.308
Q102	-.093	<b>.945</b>
Q103	.138	<b>.639</b>
Q101	.139	<b>.617</b>

Note: Bold factor loadings indicate the factor predominantly reflected by each item. Factor loadings are partial regression coefficients reflecting the influence of each factor on each item when controlling for the other factor. The latter is important because the factors to some degree share common variance due to the correlation between factors.

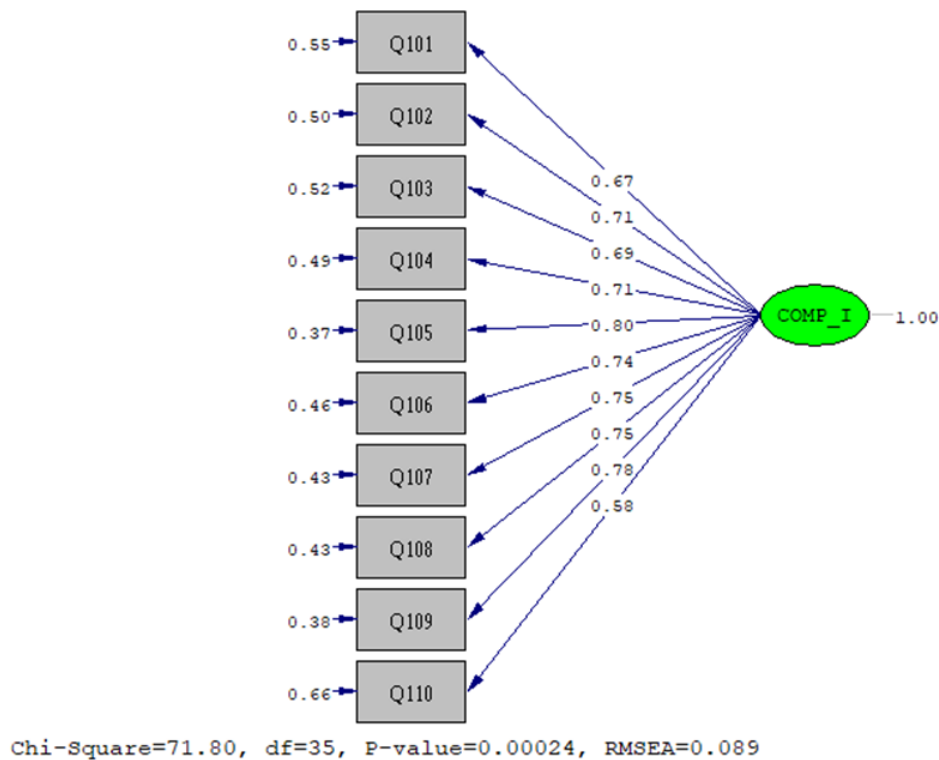

Figure 5.13. First-order *manages the internal work unit environment* measurement model (completely standardised solution)

The pattern matrix clearly revealed the existence of a two-factor structure underlying this subscale. The two-factor solution was regarded as a valid and credible explanation for the observed inter-item correlation matrix in that only 20% of the residual correlations were larger than .05. According to the pattern matrix, Q104 to Q110 loaded (magnitudes ranged between .489 and .828) onto Factor 1, and Q101 to Q103 loaded (magnitudes ranged between .617 and .945) onto Factor 2. Upon closer inspection, it was evident that factor 1 (e.g. themes relating to the regulation of the pace at which others work and the balancing of human and capital resources to expedite the speed of work) could be interpreted as the graduate leader's competence in regulating the speed of the conversion process (i.e. the temporal component), whereas factor 2

(themes relating to situational updates, quality assurance, fixing problems and managing risk, etc.) could be regarded as a graduate leader's competence in ensuring the successful outcome of the conversion process (i.e. the output component). The factor fission here was therefore also considered to be conceptually meaningful, in that both of these two "themes" represent logical facets of the *manages the internal work unit environment* competency that the subscale was designed to measure. In fact, the merging of the themes of work speed regulation and the 'real-time' management of the outcomes of the conversion process's output was exactly one of the intentions the researcher had when operationalising this second-order competency in the first place. The small number of items that loaded on factor 2 combined with the quite strong positive correlation between the two factors (.755) in the obliquely rotated solution brought the need to formally make a distinction between these two facets of the competency into question.<sup>330</sup> The small number of items that tapped into the 'real-time' management of the outcomes of the conversion process' can easily be corrected in future versions of the PGLCQ. Despite the substantial correlation between the two factors it was nonetheless argued that the conceptual distinction between the work speed regulation and the 'real-time' management of the outcomes of the conversion process's interpretations of the *manages the internal work unit environment* competency will be of value in providing formative feedback to graduate leaders during their leadership development programme. Thus, the researcher still considered the operationalisation of this construct to be 'successful' pending the outcome of a CFA on the two-factor solution, even if this competency was initially not expected to split (in a factorial sense) under the scrutiny of dimensionality analysis the way it eventually did. The decision was therefore taken not to delete some of the items that loaded on factor 2 in an attempt to achieve unidimensionality in the subscale. Achieving unidimensionality through the deletion of items would narrow the connotative meaning of the *manages the internal work unit environment* competency. The more restricted interpretation would be to the detriment of the quality of the formative feedback that graduate leaders obtain from the PGLCQ during leadership development programmes.

The subsequent fitting of the two-factor *manages the internal work environment* measurement model based on the loading pattern displayed in the pattern matrix shown in Table 5.82 is presented in Figure 5.14.

The Satorra-Bentler scaled chi-square statistic delivered a statistically insignificant value ( $\chi^2 = 40.393$ ;  $p > .05$ ) and therefore, the exact fit null hypothesis ( $H_{0i}$ : RMSEA = 0) could not be rejected. The close fit null hypothesis ( $H_{0i}$ : RMSEA  $\leq .05$ ) was therefore also not rejected (RMSEA = .038;  $p > .05$ ), which provided evidence of excellent fit for the *manages the internal work unit environment* measurement model after allowing for a multidimensional (two-factor) structure. This conclusion was corroborated by the fact that an investigation into the measurement model's standardised residual's output revealed that only two observed covariance values were underestimated (2.718 and 2.611  $\geq$  2.58) out of the 55 variances and covariances observed in the covariance matrix (4%). The fitted (two-factor) measurement model therefore succeeded in accurately reproducing 96% of the unique variance and covariances in the observed covariance matrix.

The unstandardised factor loading matrix ( $\Lambda^X$ ) for the two-factor *manages the internal work unit environment* measurement model is shown in Table 5.83.

---

<sup>330</sup> The rest of the fit statistics for the single-factor first-order measurement model suggested a reasonable to good fitting model. Given the results obtained in the EFA it should be acknowledged the evidence to conclude a second factor is somewhat tenuous.

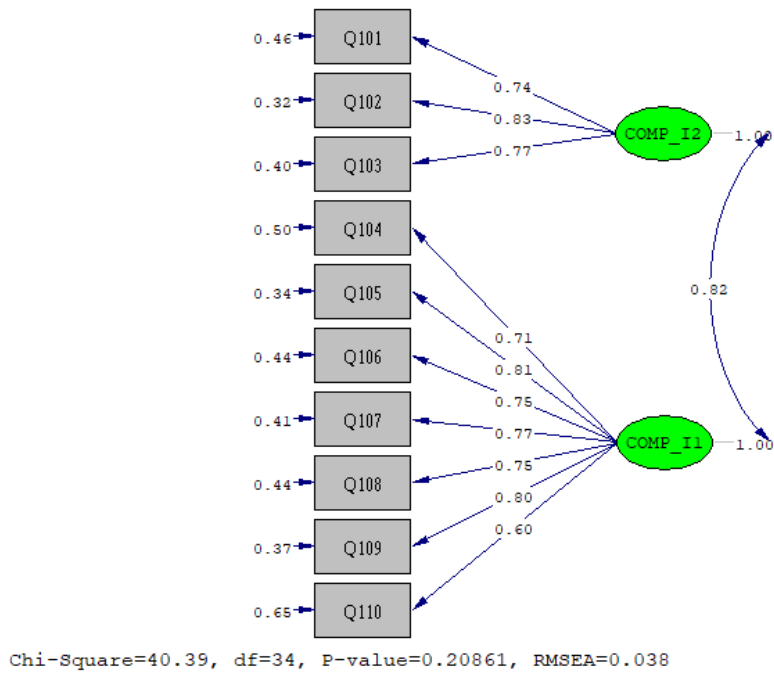

Figure 5.14. First-order two-factor manages the internal work unit environment measurement model (completely standardised solution)

Table 5.83

Unstandardised factor loading matrix ( $A^x$ ) for the two-factor manages the internal work unit environment measurement model

Item	COMP_I1	COMP_I2
Q101	--	0.6491* (0.0705) 9.2019
Q102	--	0.6761* (0.0598) 11.3157
Q103	--	0.7068* (0.0750) 9.4227
Q104	0.5949* (0.0616) 9.6640	--
Q105	0.6734* (0.0557) 12.0916	--
Q106	0.6332* (0.0593) 10.6836	--
Q107	0.6310* (0.0549) 11.4963	--
Q108	0.6045* (0.0577) 10.4702	--
Q109	0.6613* (0.0652) 10.1464	--
Q110	0.5649* (0.0803) 7.0341	--

Note: the first row in each cell in columns 2 and 3 of Table 5.83 represents the unstandardised factor loading estimate ( $\lambda_{ij}$ ), row two (in brackets) represents the standard error and the third row represents the unstandardised estimate transformed to a z-score obtained by dividing the unstandardised estimate by its standard error. \*p < .05.

Table 5.83 shows that all the items of the *manages the internal work unit environment* subscale statistically significantly ( $p < .05$ ) reflect the factor that they were designated to represent according to the pattern matrix (Table 5.82) obtained from the EFA. The null hypotheses that  $\lambda_{ij} = 0$  in the parameter could therefore be rejected for all items.

The completely standardised factor loading matrix ( $\Lambda^X$ ) for the two-factor *manages the internal work unit environment* measurement model is shown in Table 5.84.

Table 5.84

*Completely standardised factor loading matrix ( $\Lambda^X$ ) for the two-factor manages the internal work unit environment measurement model*

	COMP_I1	COMP_I2
Q101	--	.7381
Q102	--	.8264
Q103	--	.7729
Q104	.7104	--
Q105	.8113	--
Q106	.7456	--
Q107	.7687	--
Q108	.7491	--
Q109	.7956	--
Q110	.5958	--

Table 5.84 shows that all items of the subscale load satisfactorily on the factor that they were designated to reflect.

The unstandardised measurement error variance matrix for the two-factor *manages the internal work unit environment* measurement model is shown in Table 5.85 and the completely standardised measurement error variance matrix in Table 5.86.

Table 5.85

*Unstandardised measurement error variance matrix ( $\Theta_{\delta}$ ) for the two-factor manages the internal work unit environment measurement model*

Q101	Q102	Q103	Q104	Q105	Q106
0.3521*	0.2122*	0.3367	0.3474*	0.2355*	0.3203*
(0.0608)	(0.0477)	(0.0587)	(0.0524)	(0.0374)	(0.0526)
5.7922	4.4456	5.7362	6.6291	6.2898	6.0902
Q107	Q108	Q109	Q110		
0.2756*	0.2858*	0.2536*	0.5799*		
(0.0483)	(0.0519)	(0.0326)	(0.0834)		
5.7030	5.5036	7.7777	6.9503		

Note: the first row in each cell in each column of Table 5.85 represents the unstandardised measurement error variance estimate ( $\theta_{\delta i}$ ), row two (in brackets) represents the standard error and the third row represents the unstandardised estimate transformed to a z-score obtained by dividing the unstandardised estimate by its standard error.

\* $p < .05$

Table 5.86

*Completely standardised measurement error variance matrix ( $\Theta_{\delta}$ ) for the two-factor manages the internal work unit environment measurement model*

Q101	Q102	Q103	Q104	Q105	Q106
.4552	.3170	.4027	.4954	.3418	.4441
Q107	Q108	Q109	Q110		
.4090	.4389	.3671	.6450		

Regarding measurement error, an inspection of the unstandardised theta-delta matrix (Table 5.85) for the two-factor *manages the internal work unit environment* measurement model revealed that all the measurement error variances were statistically significant ( $p < .05$ ; i.e. all z

scores surpassed the critical 1.6449 threshold). The completely standardised theta-delta matrix (Table 5.86) for this two-factor measurement model revealed measurement error variances for all items that ranged between .317 and .455 (except for Q110 at .645). In practical terms, this meant that for the majority of the subscale's items, measurement error accounted for less than 50% of variance in the majority of the items in this subscale (i.e. between 32% and 46%). In addition, the  $R^2$  values for the two-factor *manages the internal work unit environment* measurement model (see Table 5.87 below) proved to be moderate to strong and ranged between .472 and .594 for the majority of items (except for Q103 with a value of .341, Q107 with a value of .403, and Q108 with a value of .369), signifying that between 47% and 59% of the variance in the majority of the items was explained by the (two-factor) construct underlying this subscale that the items intended<sup>331</sup> to reflect. Hence, given the findings of exact fit, a low percentage of standardised residuals, the existence of relatively low measurement error variance and moderate to strong magnitudes for the respective  $R^2$  values, the researcher concluded that the fitted two-factor measurement model constituted a valid (i.e. permissible) multidimensional (two-factor) description of the process that created the *manages the internal work unit environment* observed inter-item covariance matrix

Table 5.87

*R<sup>2</sup> values for the manages the internal work unit environment measurement model*

Q101	Q102	Q103	Q104	Q105
.545	.594	.341	.541	.538
Q106	Q107	Q108	Q109	Q110
.523	.403	.369	.472	.574

The factor fission of the *manages the internal work unit environment* subscale was regarded as conceptually and practically meaningful. The items of the current subscale provided psychometrically acceptable measures of the two extracted factors. However, the two sets of items comprising the current scale would have to be extended to provide separate measures of the two *manages the internal work unit environment* facets with acceptable reliabilities. This is especially true regarding the second 'real-time' management of the outcomes of the conversion process' factor. That leaves the question, in the interim, and beyond, whether the items may also be regarded as statistically significant ( $p < .05$ ) indicators of a second-order *manages the internal work unit environment* competency.

To attempt to answer this question a second-order *manages the internal work unit environment* measurement model was fitted with a single second-order *manages the internal work unit environment* factor<sup>332</sup>. The excellent fit of the two-factor first-order *manages the internal work unit environment* measurement model shown in Figure 5.14, combined with the substantial inter-factor correlation, justified the fitting of the second-order model. The completely standardised solution for the fitted two-factor second-order *manages the internal work unit environment* measurement model is shown in Figure 5.15.

<sup>331</sup> Once again, although the researcher used a variety of first-order competencies in order to "conceive" the second-order competency of manages the internal work unit environment, this second-order competency was initially operationalised as a single-factor latent construct in Chapter 2. The fact that the word "intended" is used here is, therefore, strictly speaking incorrect.

<sup>332</sup> Diagonally weighted least squares estimation was used rather than robust maximum likelihood estimation.

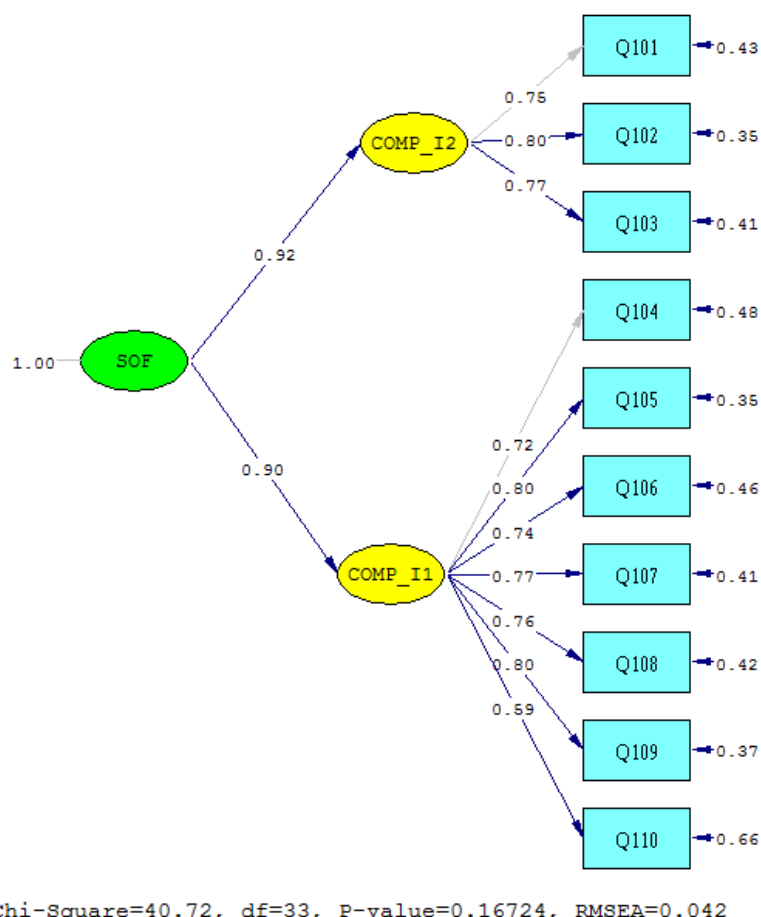

Figure 5.15. Second-order two-factor *manages the internal work unit environment* measurement model (completely standardised solution)

The Satorra-Bentler scaled chi-square returned a statistically insignificant estimate (40.7159;  $p > .05$ ). The exact fit null hypothesis ( $H_{0i}$ : RMSEA = 0) therefore needed not to be rejected. The observed sample RMSEA estimate (.04209) could therefore be fully explained in terms of sampling error. It therefore followed that the close fit null hypothesis ( $H_{0i}$ : RMSEA  $\leq .05$ ) also needed not to be rejected. The probability of observing the sample RMSEA estimate (.04209) under both the exact fit and close fit null hypotheses were therefore sufficiently large not to question either hypothesis.<sup>333</sup> No statistically significant ( $p < .01$ ) standardised covariance residuals were observed. The excellent fit obtained for the second-order two *manages the internal work unit environment* measurement model justified the calculation of the indirect effects of the second-order factor on the *manages the internal work unit environment* subscale items, and the testing of their statistical significance.

For this purpose, the SIMPLIS syntax used to fit the second-order two *manages the internal work unit environment* measurement model was translated to LISREL syntax. This allowed the use of the LISREL syntax command AP on the model command line to specify the creation of 10 additional parameters (i.e., the indirect effects) and the CO command to specify the ten indirect effects to be calculated.<sup>334</sup> The unstandardised indirect effects are shown in Table 5.88.

<sup>333</sup> The full array of fit statistics produced by LISREL 8.8 is shown in Appendix H.

<sup>334</sup> CO PAR1 = LY(1,2)\*GA(2,1)  
CO PAR2 = LY(2,2)\*GA(2,1)  
CO PAR3 = LY(3,2)\*GA(2,1)

Table 5.88

*Unstandardised indirect effects of the second-order factor on manages the internal work unit environment subscale items*

PA(1)	PA(2)	PA(3)	PA(4)	PA(5)	PA(6)
.61*	.61*	.65*	.54*	.60*	.57*
(0.09)	(0.09)	(0.09)	(0.09)	(0.09)	(0.09)
7.04	6.99	7.48	6.24	6.92	6.50
PA(7)	PA(8)	PA(9)	PA(10)		
.57*	.56*	.60*	.50*		
(0.09)	(0.09)	(0.09)	(0.09)		
6.53	6.39	6.86	5.77		

Note: the first row in each cell in each column of Table 5.88 represents the unstandardised indirect effect estimate PA<sub>i</sub> row two (in brackets) represents the standard error and the third row represents the unstandardised estimate transformed to a z-score obtained by dividing the unstandardised estimate by its standard error.

\*p < .05

Table 5.88 shows that the effect of the second-order *manages the internal work unit environment* factor, mediated by the two first-order factors, statistically significantly ( $p < .01$ ) affect all the items of the *manages the internal work unit environment* subscale. The statistical significance of the indirect effects presented in Table 5.88 above implies that the *manages the internal work unit* subscale items, despite measuring two distinct factors, could therefore still be regarded as composite indicators of a higher-order (broader) *manages the internal work unit environment* competency. It follows that the different items measuring factor 1 and factor 2 of this subscale had to be treated as subtests of the same higher-order *manages the internal work unit environment* competency – i.e. they were acknowledged to measure two different strata of the same latent (higher-order) construct and not two separate measures of two unrelated constructs. More importantly, in the interim, before the expansion of the *manages the internal work unit environment* subscale to provide psychometrically adequate measures of the two *manages the internal work unit environment* facets, the subscale items can be used as indicators of the higher-order *manages the internal work unit environment* factor.

Accordingly, the researcher again utilised the Stratified alpha Excel macro to calculate an appropriate reliability coefficient for this subscale. The value (.921) proved to be more favourable than the Cronbach alpha value (.913) that was included as part of the item analysis output (Table 5.80) for this subscale and moreover, this meant that the reliability for this subscale could be described as of an excellent standard as well. The Cronbach alphas calculated for the items loading on the two facets were .817 (factor 2) and .892 (factor 1).

## 5.6 PSYCHOMETRIC EVALUATION OF THE PGLCQ COMPETENCY QUESTIONNAIRE MEASUREMENT- AND COMPREHENSIVE GRADUATE LEADER PERFORMANCE LISREL MODELS

### 5.6.1 ITEM PARCELLING

Ultimately, the fact that only 133 completed PGLCQ responses were collected for the study's sample left the researcher with little choice but to contemplate ways in which to reduce the number of parameters to be estimated when fitting the PGLCQ competency questionnaire

---

CO PAR4 = LY(4,1)\*GA(1,1)  
 CO PAR5 = LY(5,1)\*GA(1,1)  
 CO PAR6 = LY(6,1)\*GA(1,1)  
 CO PAR7 = LY(7,1)\*GA(1,1)  
 CO PAR8 = LY(8,1)\*GA(1,1)  
 CO PAR9 = LY(9,1)\*GA(1,1)  
 CO PAR10 = LY(10,1)\*GA(1,1)



measurement and graduate leader performance structural models.<sup>335</sup> This is because SEM procedures are based on asymptotic theory and the validity of parameter estimates and test statistics in this context depend on large<sup>336</sup> samples (Baumgartner & Homburg, 1996). The researcher had a number of options at his disposal to do so, most notably by imposing certain constraints or *scale types* (e.g. specifying a parallel model<sup>337</sup>, or specifying a tau equivalent model which is essentially identical to the more restrictive parallel model, but individual item error differences are freed to differ from one another) when fitting the models or utilising item parcels to manufacture a lower indicator-to-sample ratio (i.e. combining two or more items that are used as the manifest indicators of latent constructs).

As parcelling is commonly used to reduce the ratio of variables to sample size (Bandalos & Finney, cited in Marcoulides & Schumacker, 2001; Williams & O'Boyle, 2008) and to reduce model complexity in general (Rhemtulla, 2016), the obvious methodological choice here was to utilise item parcels. Assuming parallel, or even tau equivalent measurement would have imposed unrealistically harsh restrictions on the model. The PGLCQ has been developed under a far less restrictive assumption of congeneric measurement.<sup>338</sup> In this sense parcelling seemed to be the lesser of the two evils. Although a degree of controversy has always surrounded the use of item parcels as indicators of latent factors (Little, Rhemtulla, & Gibson, 2013) because this approach leads to (artificial) indicators with better distributional and psychometric properties, and commonly, better model fit (Rhemtulla, 2016). Little, et al. (2013, p. 1) argue that “parcels *per se*, are not inaccurate, incorrect, or faulty. Matsunaga (2008, p. 289) elaborates on this sentiment by stating that “if the main purpose of a study is to examine the structural relationships among multiple constructs..., parcelling (in fact) greatly helps to eliminate theoretically unimportant noises, and thus, to unveil the latent structure that otherwise may be eclipsed by measurement and sampling error debris”. Hence, “when thoughtfully composed, parcels provide efficient, reliable, and valid indicators of latent constructs (Little et al., 2013, p. 1).

However, it is important to note that there are two situations when item parcelling should not be used. The first situation in which item parcelling should be avoided is when the researcher attempts to defend its use in comparison to the use of individual items as indicators of latent variables because it leads to improved model fit. This type of approach is criticised because “parcelling improves model fit regardless of whether the fitted model is correctly specified or not. The justification for the use of parcelling should therefore be derived from a ground that is independent of model fit, that is scale dimensionality” (Matsunaga, 2008, p. 289). Thus, “knowing the items and their theoretical content as well as the behaviour of items in a given sample (e.g. running an item-level EFA to examine the item-level content, reviewing the matrix of correlations, and running item-level reliability analysis) are critical first steps in parcel creation when the goals of a study are to examine the relations among constructs” (Little et al, 2013, p. 13). This first line of thought introduces and ties in with the second type of situation when parcelling should be

---

<sup>335</sup> I.e.  $\Lambda(90) + \Theta_{\delta}(90) + \Phi((9 \times 8)/2) = 216$  parameters to be estimated. Fitting the PGLCQ measurement model with the individual items as indicator variables would have resulted in the untenable situation that more parameters had to be estimated than there were observations in the data set.

<sup>336</sup> An explanation of what is considered to be a sufficiently large sample was discussed in Chapter 3.

<sup>337</sup> The classically parallel model requires the elements of  $\tau$ ,  $\Lambda^x$ , and  $\Theta_{\delta}$  to be equal across the indicators of each latent dimension of the construct. According to Graham (2006, p. 934) “all items must measure the same latent variable, on the same scale, with the same degree of precision, and with the same amount of error”. All item true scores are assumed to be equal to one another, and all error scores are likewise equal across items.

<sup>338</sup> The congeneric model permits the elements of  $\tau$ ,  $\Lambda^x$  and  $\Theta_{\delta}$  to vary across the indicators of each latent variable. According to Graham (2006, p. 9345) “the congeneric model assumes that each individual item measures the same latent variable, with possibly different scales, with possibly different degrees of precision, and with possibly different amounts of error. Whereas the essentially tau-equivalent model allows item true scores to differ by only an additive constant, the congeneric model assumes a linear relationship between item true scores, allowing for both an additive and a multiplicative constant between each pair of item true scores”.

avoided, and that is when scales that are intended for parcelling are not unidimensional in nature. Kline (2011, p. 181-182) aptly explain the rationale for this caveat as follows:

Parcelling is not recommended if unidimensionality cannot be assumed. Specifically, parcelling should not be part of an analysis aimed at determining whether a set of items is unidimensional. This is because it is possible that parcelling can mask a multidimensional factor structure in such a way that a seriously misspecified model may nevertheless fit the data reasonably well.

In other words, “when the research goal is to assess the measurement properties of a scale, parcelling is never recommended for the simple reason that it is impossible to study the properties of individual items once they are parcelled” (Rhemtulla, 2016, p. 348). However, the above line of reasoning applies to situations where item parcelling is used for item and dimensionality analysis, which was not the case in this study. In the present study, it was already established that six out of the nine PGLCQ subscales demonstrated a satisfactory amount of internal consistency reliability and were in fact unidimensional in nature (when fitted with individual items). Also, in the case of the PGLCQ’s ‘multidimensional’ subscales (i.e. *develops unit competitiveness, unites and connects followers, and manages the internal work unit environment*), it was shown that the factor fission that occurred here was meaningful in that the two-factor structure underlying each subscale tapped into or were manifestations (or strata) of a broader, refitted higher-order construct. Moreover, the internal consistency reliability of these composite subscales (i.e. measuring two factors of a higher-order construct) proved to be of an excellent standard. Thus, if the parcelling of even-uneven numbers were to be implemented for any of these three subscales, for example, the resulting parcels (2 per subscale) would each still be representative of the whole domain of their related overarching multidimensional construct because each parcel in each set would still share not only construct-relevant variance, but also the variance from both its underlying factors. Little et al. (2013) refer to this as *domain representative* parcels and contend that this strategy is appropriate for use in cases where a scale measures lower-order constructs that each has unique predictive effects on another (higher-order) construct. Nonetheless, the ideal in the current study would have been to have fitted the PGLCQ measurement model in which the individual subscale items are used to operationalise the nine latent competencies. The focus in the current study was on the individual items and their ability to reflect the latent graduate leader competencies they were designated to reflect. The objective of fitting the PGLCQ measurement model is to determine overall whether the design intention to measure nine (correlated) latent graduate leader competencies via specific sets of ten individual items succeeded *in totality*.

Thus, as the aim of the study was to test a specific hypothesis about the nature of the latent structure underlying the PGLCQ subscales and the employment of item parcels was a conscious, albeit regrettable, decision to lower the number of parameters to be estimated for the fitting of the PGLCQ measurement model to 72 (instead of 216) thereby rendering it *theoretically overidentified*, the researcher felt it best to proceed with a domain-representative parcelling scheme *a priori*. Consequently, because all of the items were retained after the item and dimensionality analyses of the PGLCQ’s various subscales and the use of aggregated indicators would still permit *domain-representativeness* (Little et al., 2013), the researcher proceeded to create item parcels by utilising the means of the odd-even items for each subscale for this purpose via SPSS.<sup>339</sup>

---

<sup>339</sup> The decision to use the domain parcelling strategy only really affected the calculation of item parcels for the three subscales where factor fission occurred (i.e. *develops unit competitiveness, unites and connects followers, and manages the internal work unit environment*). In the case of these three subscales the alternative, more conventional, option would have been to calculate the means of the items loading on the two extracted factors for each of the subscales.

## 5.6.2 PSYCHOMETRIC EVALUATION OF THE PGLCQ COMPETENCY QUESTIONNAIRE MEASUREMENT MODEL

### 5.6.2.1 Introduction

The overarching substantive hypothesis (i.e. Hypothesis 1) claimed that the PGLCQ provides a reliable and construct valid measure of the graduate leader performance construct (interpreted behaviourally). The overarching substantive hypothesis was in turn dissected into two narrower substantive research hypotheses in Chapter 3:

- Hypothesis 1a: The measurement model reflecting the constitutive definition of the graduate leader performance construct (interpreted behaviourally) and the design intent of the PGCQ provide a valid account of the psychological mechanism that regulates test-takers' responses to the items of the PGLCQ; and
- Hypothesis 1b: The structural model implied by the connotative meaning of the graduate leadership performance construct (interpreted behaviourally) as expressed by the internal structure assigned to the construct taken in conjunction with the design intent of the PGLCQ provides a valid account of the psychological processes underpinning the level of performance that graduates attain on the behavioural components of the graduate leader job performance construct.

The first narrow overarching substantive hypothesis in this study was that the measurement model reflecting the constitutive definition of the graduate leader performance construct (interpreted behaviourally) and the design intent of the PGLCQ provide a valid account of the psychological mechanism that regulates test-takers' responses to the items of the PGLCQ (Hypothesis 1a). As the eventual sample only included self-rater<sup>340</sup> responses and the researcher opted to employ a *domain-representative* parcelling approach, the researcher had to accommodate these research design alterations in the way in which the PGLCQ competency questionnaire measurement and comprehensive structural models were originally specified in Chapter 3, as well as in the manner in which the study's operational hypotheses were eventually formulated. The overarching substantive research hypothesis (i.e. Hypothesis 1) remained unaffected. The two narrower substantive research hypotheses into which the overarching substantive hypothesis was dissected also remained unaffected. More specifically, the employment of item parcels and the use of a multitrait single-rater matrix necessitated that the study's measurement model had to be respecified as per equation 5.1 below:

$$\mathbf{X} = \Lambda^x \boldsymbol{\xi} + \boldsymbol{\delta} \text{-----} [5.1]$$

where:

- $\mathbf{X}$  is a 18x1 column vector of observed item parcel scores;
- $\Lambda^x$  is a 18x9 factor matrix of factor loadings describing the slope of the regression of  $X_i$  on  $\xi_j$ ;
- $\boldsymbol{\xi}$  is a 9x1 column vector of second-order graduate leader competencies; and
- $\boldsymbol{\delta}$  is a 18x1 column vector of measurement error terms representing the combined effect of random measurement error and systematic non-relevant error influences.

In addition, the study's operational hypotheses 1–5 had to be adjusted as follows:

---

<sup>340</sup> It is acknowledged that this statement is not true. Due to a limited number of responses, the researcher added the other-rater responses to the self-rater responses. This is acknowledged as a methodological limitation as it ignored a known systematic source of variance in the responses to the PGLCQ items. Formally modelling this source of variance (i.e. the nature of the rater), however, required that all graduate leaders should have been exposed to multi-rater assessments. This limitation could have been avoided by simply not including the other-rater responses in the analysis. The difficulty in getting a large enough sample of self-ratings swayed the researcher's decision not to do so.

- **Operational hypothesis 1:** The measurement model implied by the scoring key and the design intent of the PGLCQ, when a domain-representative parcelling scheme is used to group items into two parcels per latent competency, closely reproduces the covariances observed between the PGLCQ item parcels;<sup>341</sup>
- **Operational hypothesis 2:** The factor loadings of the item parcels on their designated (second-order) graduate leader competencies respectively are statistically significant ( $p < .05$ ) and large ( $\lambda_{ij} \geq .71$ );<sup>342</sup>
- **Operational hypothesis 3:** The graduate leader (second-order) competencies duly explain large proportions (i.e.,  $> .50$ ) of the variance in the item parcels that represent them respectively;
- **Operational hypothesis 4:** The measurement error variances associated with each item parcel are statistically significant ( $p < .05$ ) yet small ( $\theta_{\delta ii} \leq .50$ ); and
- **Operational hypothesis 5:** competencies (as measured by item parcels) correlate statistically significantly ( $p < .05$ ) while not excessively high with each other ( $\phi_{ij} < .90$ ),<sup>343</sup> providing evidence of *discriminant validity*.

In order to test the first overarching substantive hypothesis (Hypothesis 1a), the researcher conducted a confirmatory factor analysis via LISREL 8.8. The fit obtained for the PGLCQ measurement model and the credibility of the parameter estimates will be discussed in the sections that follow. The discussion will unfold by: a) an evaluation of the overall model fit based on an array of model fit indices reported by LISREL, an assessment of the standardised residuals, and an examination of the modification indices calculated for  $\Lambda^*$  and  $\Theta_{\delta}$ ; b) by interpreting the measurement model parameter estimates; and c) by investigating the discriminant validity of the PGLCQ. The statistical hypotheses formulated initially for the PGLCQ measurement model also had to be adapted due to the decision to use item parcels to operationalise the latent second-order graduate leadership competencies. These adapted statistical hypotheses will be presented when the PGLCQ measurement model parameter estimates are interpreted.

### 5.6.3 UNIVARIATE AND MULTIVARIATE NORMALITY OF THE COMPOSITE INDICATORS CALCULATED FOR THE PGLCQ COMPETENCY QUESTIONNAIRE MEASUREMENT MODEL

As many of the estimation techniques used in SEM operate on the assumption of multivariate normality, the researcher had to examine the (now item parcelled) data for univariate and multivariate outliers prior to the fitting of the PGLCQ measurement model. As shown below in Table 5.89, only one indicator variable (Comp\_A2)<sup>344</sup> did not pass the test of univariate normality

<sup>341</sup> The statistical hypotheses associated with operational hypothesis 1 are the same as those formulated in Chapter 3. The measurement model they refer to, however, differs from the model the hypotheses in Chapter 3 referred to.

<sup>342</sup> The fact that the latent graduate leader competencies were operationalised via item parcels rather than the individual subscale items as originally intended, necessitated the upward adjustment of the critical factor loading value from .50 to .71. The expectation is, therefore that at least 50% (i.e.  $\lambda^2_{ij} = .71^2 = .50$ ) of the variance in the composite indicators should be explained by the latent graduate leader competency they were designated to reflect.

<sup>343</sup> It is acknowledged that a correlation of .90 can only with great difficulty be described as a moderate correlation. Nonetheless the researcher has set himself a rather lenient cut-off value in terms of which to judge discriminant validity in terms of the point estimates obtained in the sample. Additional criteria were mobilised to evaluate the discriminant validity of the PGLCQ. Probably the most important question is whether the possibility that any  $\phi_{iq}$  is unity in the parameter can be ruled out.

<sup>344</sup> Note: Comp\_A1 and Comp\_A2 refer to the two item parcels operationalising the *displays personal leader proficiency* latent variable (COMP\_A); Comp\_B1 and Comp\_B2 refer to the two item parcels operationalising the *analyses and understands the external and internal work unit environment* variable (COMP\_B); Comp\_C1 and Comp\_C2 refer to the two item parcels operationalising the *creates an exciting and aspirational vision for the unit* latent variable (COMP\_C); Comp\_D1 and Comp\_D2 refer to the two item parcels operationalising the *entrenches a high-performance culture in the unit* latent variable (COMP\_D); Comp\_E1 and Comp\_E2 refer to the two item parcels operationalising the *develops unit competitiveness* latent variable (COMP\_E); Comp\_F1 and Comp\_F2 refers to the two item parcels operationalising the *involves others and elicits participation* latent variable (COMP\_F); Comp\_G1 and Comp\_G2 refer to the two item parcels operationalising the

( $p < .05$ ). However, this was to be expected as the aggregation of items in a subscale that are non-normally distributed (all of the PGLCQ's individual subscales were found to be non-normally distributed) into a parcel, generally leads to a more normally distributed (composite) indicator (Bandalos, 2008; Hau & Marsh, 2004). Univariate normality is, however, not the primary assumption made by the default estimation technique used by LISREL 8.8 when analysing a covariance matrix. Regardless of quite positive univariate normality findings, the null hypothesis that the (item parcelled) data followed a multivariate normal distribution, as shown in Table 5.90, still had to be rejected (skewness and kurtosis chi-square = 46.612;  $p < .05$ ).

Table 5.89

*PRELIS tests of univariate normality for the PGLCQ item parcels*

Variable	Skewness		Kurtosis		Skewness and Kurtosis	
	z-score	p-value	z-score	p-value	Chi-square	p-value
Comp_A1	-2.473	.013	1.645	.100	8.820	.102
Comp_A2	-2.565	.010	1.555	.120	8.996	.011*
Comp_B1	0.162	.872	0.293	.769	0.112	.946
Comp_B2	-0.923	.356	1.739	.082	3.876	.144
Comp_C1	-1.505	.132	0.748	.454	2.825	.244
Comp_C2	-1.216	.224	1.194	.233	2.904	.234
Comp_D1	-0.795	.427	-0.0362	.718	0.762	.683
Comp_D2	-1.589	.112	-.627	.531	2.917	.233
Comp_E1	0.309	.758	0.914	.361	0.931	.628
Comp_E2	-0.334	.738	0.502	.616	0.363	.834
Comp_F1	0.089	.929	1.888	.059	3.571	.168
Comp_F2	-0.662	.508	2.290	.022	5.681	.058
Comp_G1	0.124	.901	0.789	.430	0.637	.727
Comp_G2	0.019	.985	-0.061	.951	0.004	.998
Comp_H1	-1.752	.080	0.861	.389	3.810	.149
Comp_H2	-0.587	.557	1.044	.297	1.435	.488
Comp_I1	-1.209	.227	0.672	.501	1.915	.384
Comp_I2	-0.430	.667	0.842	.400	0.895	.639

\* $p < .05$ 

Table 5.90

*PRELIS test of multivariate normality for the PGLCQ item parcels*

Value	Skewness		Kurtosis			Skewness and Kurtosis	
	z-score	p-value	Value	z-score	p-value	Chi-Square	p-value
63.537	5.244	.000	380.555	4.372	.000	46.612	.000

*unites and connects followers* latent variable (COMP\_G); Comp\_H1 and Comp\_H2 refer to the two item parcels operationalising the *strengthens and enables followers* latent variable (COMP\_H); and Comp\_I1 and Comp\_I2 refer to the two item parcels operationalising the *manages the internal work unit environment* latent variable (COMP\_I).

Consequently, the PGLCQ measurement model was fitted via RML as per Figure 5.16. below.

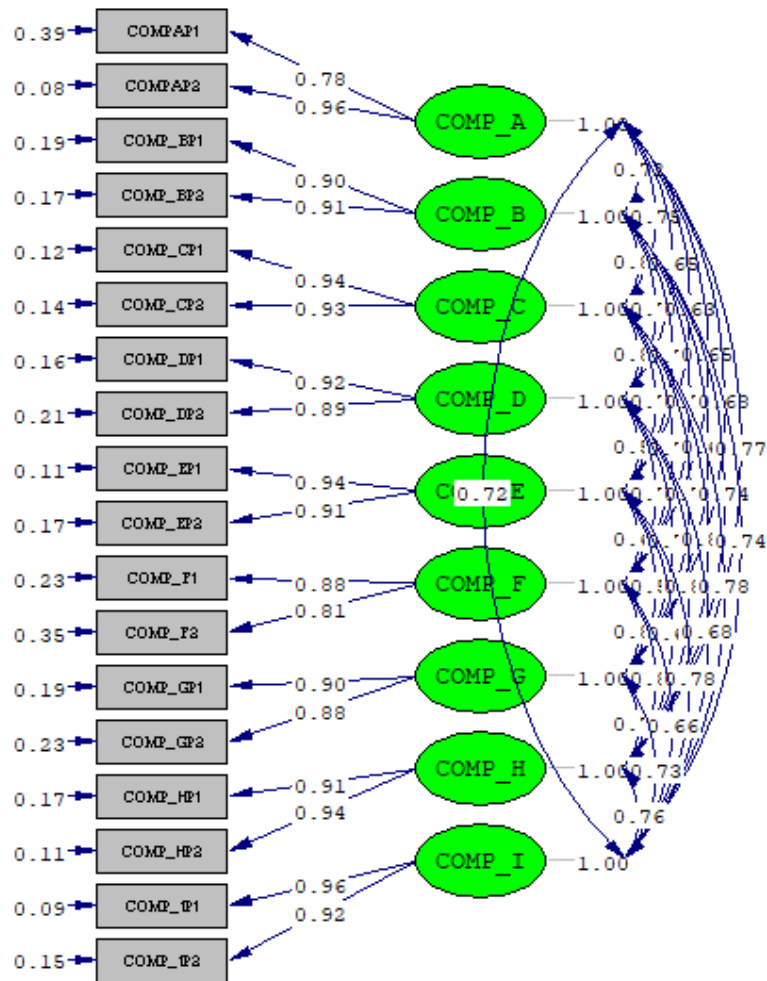

Chi-Square=142.34, df=99, P-value=0.00285, RMSEA=0.058

Figure 5.16. Representation of the PGLCQ measurement model (completely standardised solution)

#### 5.6.4 ASSESSING THE OVERALL GOODNESS OF FIT OF THE PGLCQ COMPETENCY QUESTIONNAIRE MEASUREMENT MODEL

Operational hypothesis 1 was tested by testing the following exact fit and close fit null hypotheses:

Exact fit:

$H_{01}$ : RMSEA = 0

$H_{a1}$ : RMSEA > 0

Close fit:

$H_{02}$ : RMSEA ≤ .05

$H_{a2}$ : RMSEA > .05

Table 5.91 below depicts the full array of fit statistics calculated by LISREL 8.8 for the evaluation of model fit. Of specific importance for the purpose of evaluating the fit of the PGLCQ competency questionnaire measurement model, however, was the Satorra-Bentler chi-square statistic and the RMSEA value. The Satorra-Bentler chi-square delivered a statistically significant value ( $\chi^2 = 142.34$ ;  $p < .05$ ). This indicated that the PGLCQ measurement model did not demonstrate exact fit in the parameter and therefore, the null hypothesis of exact fit ( $H_{01}$ : RMSEA = 0) was rejected. The RMSEA value (.057), however, was indicative of reasonable model fit in the sample approximating close fit in the sample. The probability of observing the sample RMSEA value (.058) under the close fit null hypothesis was, however, sufficiently large ( $p > .05$ ) not to reject the close fit null hypothesis ( $H_{02}$ : RMSEA  $\leq$  .05). It was therefore permissible to hold the position that the PGLCQ measurement model (with latent graduate leader competencies operationalised via item parcels) fitted closely in the parameter.

Table 5.91

*Basket of goodness of fit statistics for the PGLCQ Competency Questionnaire Measurement Model*

Goodness of Fit Statistics	
Degrees of Freedom = 99	
Minimum Fit Function Chi-Square	= 158.453 (P = 0.000139)
Normal Theory Weighted Least Squares Chi-Square	= 147.870 (P = 0.00107)
Satorra-Bentler Scaled Chi-Square	= 142.340 (P = 0.00285)
Chi-Square Corrected for Non-Normality	= 408.269 (P = 0.0)
Estimated Non-centrality Parameter (NCP)	= 43.340
90 Percent Confidence Interval for NCP	= (15.587 ; 79.101)
Minimum Fit Function Value	= 1.200
Population Discrepancy Function Value (F0)	= 0.328
90 Percent Confidence Interval for F0	= (0.118 ; 0.599)
Root Mean Square Error of Approximation (RMSEA)	= 0.0576
90 Percent Confidence Interval for RMSEA	= (0.0345 ; 0.0778)
P-Value for Test of Close Fit (RMSEA < 0.05)	= .268
Expected Cross-Validation Index (ECVI)	= 2.169
90 Percent Confidence Interval for ECVI	= (1.959 ; 2.440)
ECVI for Saturated Model	= 2.591
ECVI for Independence Model	= 58.505
Chi-Square for Independence Model with 153 Degrees of Freedom	= 7686.711
Independence AIC	= 7722.711
Model AIC	= 286.340
Saturated AIC	= 342.000
Independence CAIC	= 7792.737
Model CAIC	= 566.445
Saturated CAIC	= 1007.250
Normed Fit Index (NFI)	= .981
Non-Normed Fit Index (NNFI)	= .991
Parsimony Normed Fit Index (PNFI)	= .635
Comparative Fit Index (CFI)	= .994
Incremental Fit Index (IFI)	= .994
Relative Fit Index (RFI)	= .971
Critical N (CN)	= 125.865
Root Mean Square Residual (RMR)	= .0117
Standardized RMR	= 0.0284
Goodness of Fit Index (GFI)	= 0.889
Adjusted Goodness of Fit Index (AGFI)	= .809
Parsimony Goodness of Fit Index (PGFI)	= .515

In addition and following the examples of Bakker, Demerouti and Verbeke (2004) and Yan, Qin, Zhang and Xiao (2019) in terms of their approaches in assessing the quality of measurement model fit, the researcher also considered the current study's Adjusted Goodness of Fit Index (AGFI), the Non-Normed Fit Index (NNFI) and Comparative Fit Index (CFI) model fit statistics for this purpose. The majority opinion of these model fit statistics also pointed towards reasonable or close fit in the parameter. In this regard, both the CFI (.994) and NNFI (.991) surpassed the conventional cut-off ( $> .95$ ) (Kumar, 2015) guideline with the AGFI (.809) only barely missing its conventional suggested cut-off guideline ( $> .90$ ) (Hooper et al., 2008).

### 5.6.5 EVALUATION OF THE STANDARDISED RESIDUALS OBTAINED FOR THE PGLCQ COMPETENCY QUESTIONNAIRE MEASUREMENT MODEL

The large, statistically significant ( $p < .01$ ) standardised residuals ( $> 2.58$  or  $< -2.58$ ) for the PGLCQ measurement model are summarised in Table 5.92 below. The fitted PGLCQ measurement model did not over- or underestimate any of the  $171^{345}$  variances and covariances observed in the covariance matrix (0%). The fitted measurement model therefore succeeded in accurately reproducing all of the unique variances and covariances in the observed sample covariance matrix. The non-existence of large residuals commented extremely favourably on the fit of the PGLCQ competency questionnaire measurement model. This finding dovetails with the low Standardised Root Mean Square Residual (SRMR) reported in Table 5.91 (.0284).

Table 5.92

#### *Summary statistics for the standardised residuals for the PGLCQ measurement model*

Standardised residual	Value
Smallest standardised residual	-2.112
Median standardised residual	0.000
Largest standardised residual	2.019

The distribution of the standardised residuals is shown in Figure 5.17. In order to support the finding of good fit, the spread of the residuals should have been dispersed in a symmetrical shape around zero. Figure 5.17 indicates that although the median standardised residual was in fact zero, the distribution was slightly negatively skewed (i.e. the positive residuals tended to dominate), which suggested that the model parameters were more inclined to underestimate the observed variance and covariance terms rather than to overestimate them. Nevertheless, the stem-and-leaf plot provided adequate evidence of good (or close) fit.

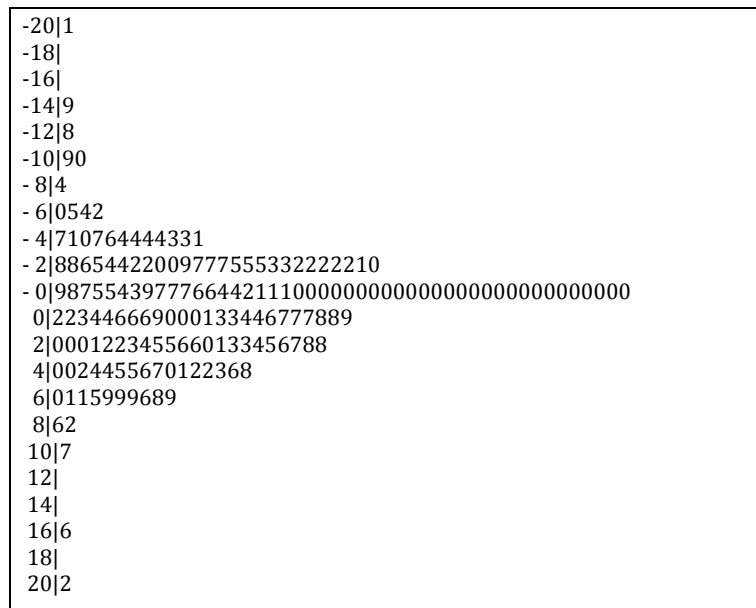

Figure 5.17. Stem-and-leaf plot of the standardised residuals for the PGLCQ measurement model

The Q-plot for the PGLCQ competency questionnaire measurement model is depicted in Figure 5.18. The Q-plot shows that the PGLCQ data deviated somewhat from the 45-degree reference line. In this regard, it was evident that the data points rotated away from the 45-degree reference

---

<sup>345</sup>  $(18 \times 19)/2 = 342/2 = 171$



line (in a non-linear fashion) at the upper end in a negative direction, and in the lower end in a positive direction. As the ideal would have been for the Q-plot to perfectly superimpose itself on the 45-degree reference line, this finding corroborated the conclusion that a normal distribution of the variance-covariance residuals was not achieved. However, the model residual results still suggested that satisfactory (or close) fit was achieved.

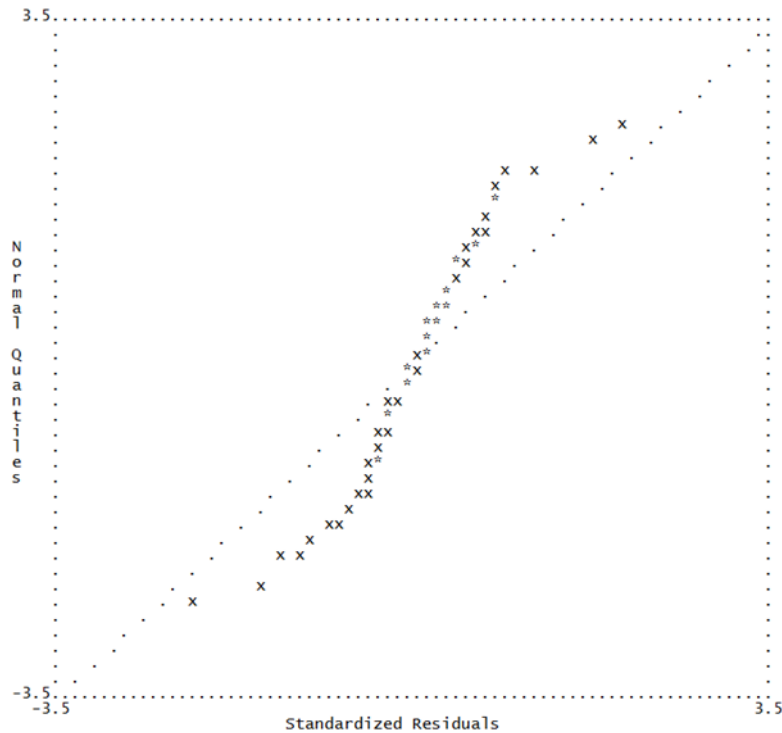

Figure 5.18. Q-plot for the PGLCQ measurement model

### 5.6.6 EVALUATION OF THE MODIFICATION INDICES OBTAINED FOR THE PGLCQ COMPETENCY QUESTIONNAIRE MEASUREMENT MODEL

The PGLCQ was developed with the intention that the only source of systematic variance shared by all the items of a subscale should be the designated latent graduate leader competency it was developed to measure. The PGLCQ measurement model was consequently fitted so that each item parcel only loaded on its designated latent graduate leader competency (the remaining eight factor loadings in the factor loading matrix  $\Lambda$  were fixed to zero) and the measurement error terms associated with the eighteen item parcels were not allowed to correlate (i.e.  $\theta_{\delta i q}$  in the measurement error variance-covariance matrix  $\Theta_{\delta}$  were fixed to zero). If these design intentions failed, it would negatively affect model fit and it would show itself in numerous modification index values for  $\Lambda$  and/or  $\Theta_{\delta}$  that would be statistically significant ( $p < .01$ ). As shown in Table 5.93 below, only four modification index values in  $\Lambda^*$  were larger than 6.64. Modification indices with values larger than 6.64 identify currently fixed parameters that would enhance the fit of a model significantly ( $p < .01$ ) if set free (Diamantopoulos & Siguaw, 2000). The small percentage (approximately 2.8%) of large modification index values for  $\Lambda^*$  ( $4/((9 \times 18) - 18) = 4/144$ ) therefore commented favourably on the fit of the PGLCQ measurement model. On the other hand, the modification indices calculated for  $\Theta_{\delta}$  are shown in Table 5.94. As per Table 5.94, five of the modification index values calculated for the off-diagonal of  $\Theta_{\delta}$  were larger than 6.64. The fact that there was only a modest percentage of (approximately 10%) of modification indices greater than the cut-off value ( $5/((18 \times 17))/2 = 5/153 = .094$ ), also commented reasonably favourably on the fit of the PGLCQ measurement model.

However, the modest percentage does suggest, albeit not very strongly, that the addition of a broad, general graduate leadership factor, uncorrelated with the nine, more specific, latent general graduate leader competencies, might improve the fit of the PGLCQ measurement model. Although such a bifactor model (Reise, 2012) was not initially considered in the conceptualisation of the graduate leader performance construct, the possibility of a latent broad, general graduate leader competency, independent of the narrower, more specific latent graduate leader competencies, does make conceptual sense. A bifactor model was subsequently fitted that allowed each item parcel to load on a broad, general latent graduate leader competency (GEN) as well as on a single narrow, more specific latent graduate leader competency and that constrained the correlations between the GEN and the narrow, more specific latent graduate leader competencies to zero. Although the model fit improved, the solution was inadmissible due to an inadmissible  $\phi_{jk}$  estimate and an inadmissible  $\theta_{\delta ii}$  estimate. Moreover, it would make more sense to explore the possibility of the presence of a latent broad, general, graduate leader competency that explains unique variance in the PGLCQ items, not explained by the current latent graduate leader competencies, by fitting the PGLCQ with individual items.

The basket of evidence obtained from the fit statistics, the standardised residuals and the modification indices warranted the interpretation of the PGLCQ measurement model parameter estimates.

Table 5.93

*Modification indices for the factor loading (lambda-X) matrix*

	COMP_A	COMP_B	COMP_C	COMP_D	COMP_E	COMP_F	COMP_G	COMP_H	COMP_I
COMP_A1	--	1.672	0.820	0.898	1.609	1.275	<b>10.589*</b>	0.066	1.043
COMP_A2	--	0.678	0.195	0.279	0.897	0.305	4.209	0.008	0.248
COMP_B1	0.042	--	0.750	0.516	0.153	3.327	0.593	0.228	1.415
COMP_B2	0.098	--	2.951	1.160	0.243	<b>7.224*</b>	1.181	0.940	2.261
COMP_C1		0.033	--	0.037	0.335	0.091	0.472	0.317	0.218
COMP_C2	0.487	0.050	--	0.045	0.659	0.093	0.492	0.479	0.382
COMP_D1	0.305	0.270	0.048	--	0.663	0.022	0.280	0.004	0.063
COMP_D2	0.359	0.259	0.079	--	0.762	0.032	0.436	0.007	0.084
COMP_E1	2.202	0.372	0.016	0.183	--	1.237	1.329	0.005	0.017
COMP_E2	2.732	0.534	0.025	0.229	--	1.563	1.563	0.006	0.017
COMP_F1	1.913	2.304	1.780	0.748	0.117	--	0.131	0.000	7.589*
COMP_F2	2.623	4.463	3.830	2.477	0.169	--	0.417	0.001	<b>10.684*</b>
COMP_G1	1.098	0.541	0.011	0.038	0.038	0.086	--	0.039	0.000
COMP_G2	0.777	0.397	0.007	0.024	0.032	0.053	--	0.021	0.000
COMP_H1	1.612	0.045	0.196	2.277	0.999	0.476	0.417	--	2.139
COMP_H2	1.803	0.061	0.199	2.838	1.204	0.491	0.399	--	3.091
COMP_I1	0.033	5.629	0.077	1.995	2.231	<b>8.557*</b>	1.891	2.995	--
COMP_I2	0.019	1.500	0.027	1.395	0.620	4.701	1.374	0.673	--

\*p&lt;.01

Note: Comp\_A1 and Comp\_A2 refer to the two item parcels operationalising the *displays personal leader proficiency* latent variable (COMP\_A); Comp\_B1 and Comp\_B2 refer to the two item parcels operationalising the *analyses and understands the external and internal work unit environment* variable (COMP\_B); Comp\_C1 and Comp\_C2 refer to the two item parcels operationalising the *creates an exciting and aspirational vision for the unit* latent variable (COMP\_C); Comp\_D1 and Comp\_D2 refer to the two item parcels operationalising the *entrenches a high-performance culture in the unit* latent variable (COMP\_D); Comp\_E1 and Comp\_E2 refer to the two item parcels operationalising the *develops unit competitiveness* latent variable (COMP\_E); Comp\_F1 and Comp\_F2 refer to the two item parcels operationalising the *Involves others and elicits participation* latent variable (COMP\_F); Comp\_G1 and Comp\_G2 refer to the two item parcels operationalising the *unites and connects followers* latent variable (COMP\_G); Comp\_H1 and Comp\_H2 refer to the two item parcels operationalising the *strengthens and enables followers* latent variable (COMP\_H); and Comp\_I1 and Comp\_I2 refer to the two item parcels operationalising the *manages the internal work unit environment* latent variable (COMP\_I). Statistically significant ( $p < .01$ ) modification index values are indicated in bold.

Table 5.94

*Modification indices for the measurement error variance-covariance (theta-delta) matrix*

	COMP_A1	COMP_A2	COMP_B1	COMP_B2	COMP_C1	COMP_C2	COMP_D1	COMP_D2	COMP_E1	COMP_E2	COMP_F1	COMP_F2
COMP_A1	--											
COMP_A2	--	--										
COMP_B1	0.109	0.017	--									
COMP_B2	0.693	0.513	--	--								
COMP_C1	0.008	0.351	4.369	5.845	--	--						
COMP_C2	0.208	0.707	0.547	1.200	--	--						
COMP_D1	0.071	0.841	0.579	1.280	1.027	1.555	--	--				

Table 5.94

*Modification indices for the measurement error variance-covariance (theta-delta) matrix (continued)*

	COMP_A1	COMP_A2	COMP_B1	COMP_B2	COMP_C1	COMP_C2	COMP_D1	COMP_D2	COMP_E1	COMP_E2	COMP_F1	COMP_F2
COMP_D2	0.100	0.260	0.006	0.229	1.059	1.631	--	--				
COMP_E1	0.592	5.418	4.610	0.143	1.546	1.989	0.522	0.178	--	--		
COMP_E2	0.232	2.410	<b>12.226*</b>	2.425	0.537	0.780	0.006	1.885	--	--		
COMP_F1	1.330	1.881	1.694	1.322	0.749	0.174	0.001	0.397	3.650	<b>10.833*</b>	--	--
COMP_F2	3.115	3.136	0.033	0.002	2.375	1.089	0.021	0.398	0.256	1.015	--	--
COMP_G1	1.538	3.495	0.451	1.459	5.125	4.044	1.751	2.801	0.002	0.000	2.695	3.733
COMP_G2	2.558	0.067	2.444	4.364	2.066	1.345	0.864	1.644	0.222	0.311	0.303	0.384
COMP_H1	2.002	0.001	0.231	0.125	0.143	0.001	4.982	0.001	0.370	0.197	0.623	2.895
COMP_H2	<b>7.324*</b>	1.184	0.186	0.125	1.839	1.051	5.163	0.066	0.098	0.277	0.618	0.044
COMP_I1	0.074	0.193	4.688	<b>10.739*</b>	1.468	0.055	1.033	0.527	1.173	0.027	0.781	0.468
COMP_I2	0.612	0.019	0.658	4.043	0.901	0.017	0.232	0.016	1.119	0.004	2.213	<b>13.270*</b>

Table 5.94

*Modification indices for the measurement error variance-covariance (theta-delta) matrix (continued)*

	COMP_G1	COMP_G2	COMP_H1	COMP_H2	COMP_I1	COMP_I2
COMP_G1	--					
COMP_G2	--	--				
COMP_H1	0.057	0.501	--			
COMP_H2	0.008	0.636	--	--		
COMP_I1	0.175	0.596	0.332	0.385	--	
COMP_I2	0.007	0.211	0.115	0.047		

\*p&lt;.01

Note: Comp\_A1 and Comp\_A2 refer to the two item parcels operationalising the *displays personal leader proficiency* latent variable (COMP\_A); Comp\_B1 and Comp\_B2 refer to the two item parcels operationalising the *analyses and understands the external and internal work unit environment* variable (COMP\_B); Comp\_C1 and Comp\_C2 refer to the two item parcels operationalising the *creates an exciting and aspirational vision for the unit* latent variable (COMP\_C); Comp\_D1 and Comp\_D2 refer to the two item parcels operationalising the *entrenches a high-performance culture in the unit* latent variable (COMP\_D); Comp\_E1 and Comp\_E2 refer to the two item parcels operationalising the *develops unit competitiveness* latent variable (COMP\_E); Comp\_F1 and Comp\_F2 refer to the two item parcels operationalising the *Involves others and elicits participation* latent variable (COMP\_F); Comp\_G1 and Comp\_G2 refer to the two item parcels operationalising the *unites and connects followers* latent variable (COMP\_G); Comp\_H1 and Comp\_H2 refer to the two item parcels operationalising the *strengthens and enables followers* latent variable (COMP\_H); and Comp\_I1 and Comp\_I2 refer to the two item parcels operationalising the *manages the internal work unit environment* latent variable (COMP\_I). Statistically significant ( $p < .01$ ) modification index values are indicated in bold.

### 5.6.7 INTERPRETING THE PGLCQ COMPETENCY QUESTIONNAIRE MEASUREMENT MODEL PARAMETER ESTIMATES

Good measurement model fit does not imply that the PGLCQ measured the nine latent graduate leader competencies in a manner that permits the derivation of construct-referenced inferences on graduate leaders' standing on these competencies. Nor does it imply that the PGLCQ successfully differentiated between the nine latent graduate leader competencies as related, but qualitatively distinct competencies. Good fit only means that the measurement model parameter estimates may be regarded as valid (i.e., permissible), plausible and credible in the sense that they were able to reasonably accurately reproduce the observed variance-covariance matrix. For this reason, the researcher further inspected the PGLCQ measurement model's parameter estimates. More specifically, the researcher wanted to investigate the magnitude and the statistical significance of the slope of the regression of the observed variables (item parcels) on their respective latent variables in the unstandardised and completely standardised factor loading ( $\lambda$ -X) matrix, and the magnitude and the statistical significance of the measurement error variances in the unstandardised and completely standardised measurement error variance-covariance ( $\theta$ - $\delta$ ) matrix. In this regard, the hope was that the item parcels proved to be valid reflections of the latent variables they were earmarked to reflect as evidenced by the slope of the regression of  $X_i$  on  $\xi_j$  being statistically significant ( $p < .05$ ) and large, and as evidenced by small yet statistically significant ( $p < .05$ ) measurement error variances associated with  $X_i$  (Diamantopoulos & Siguaw, 2000).

#### 5.6.7.1 The factor loading ( $\lambda$ -X) matrix

The unstandardised and completely standardised solutions for the  $\lambda$ -X matrix of the PGLCQ measurement model are presented in Tables 5.95 and 5.96 below. In both these solutions, the factor loadings represent the slope of the regression of the item parcels on the latent variables. In the case of the latter, the slope of the regression between item parcels (as indicators) and latent variables are standardised to a z-score metric, while in the case of the former, both item parcels and the latent variables are expressed in their original metric. In practical terms, the ideal was for the PGLCQ competency questionnaire to maximise the item (parcel) variance attributable to the latent variables that each item parcel was designed to reflect.

Consequently, the factor loading estimates were interpreted against the backdrop of the following hypothesis:

- **Operational hypothesis 2:** The factor loadings of the item parcels on their designated (second-order) graduate leader competencies respectively are statistically significant ( $p < .05$ ) and large ( $\lambda_{ij} \geq .71$ ).

Operational hypothesis 2 was tested by testing the following 18 null hypotheses on the slope of the regression of item  $j$  on specific latent graduate leader competencies  $k$  (i.e. by testing the following 18 null hypotheses on the freed elements of  $\Lambda^X$ ):

$$H_{0i}: \lambda_{jk} = 0; i = 3, 4, \dots, 20; j = 1, 2, \dots, 18; k = 1, 2, \dots, 9$$

$$H_{ai}: \lambda_{jk} > 0; i = 3, 4, \dots, 20; j = 1, 2, \dots, 18; k = 1, 2, \dots, 9^{346}$$

---

<sup>346</sup> The directional Hai hypotheses imply that all the items of the PGLCQ were coded so that they load positively on the latent competency they were earmarked to reflect. The slopes of the regression of the item parcels on the latent graduate leader competencies are therefore also expected to be positive.

Table 5.95

*Unstandardised lambda-X matrix for the PGLCQ measurement model*

	COMP_A	COMP_B	COMP_C	COMP_D	COMP_E	COMP_F	COMP_G	COMP_H	COMP_I
COMP_A1	0.476* (0.053) 8.964	--	--	--	--	--			
COMP_A2	0.575* (0.049) 11.794	--	--	--	--	--			
COMP_B1	--	0.585* (0.045) 12.962	--	--	--	--			
COMP_B2	--	0.674* (0.059) 11.342	--	--	--	--			
COMP_C1	--	--	0.679* (0.051) 13.386	--	--	--			
COMP_C2	--	--	0.655* (0.053) 12.299	--	--	--			
COMP_D1	--	--	--	0.578* (0.041) 13.929	--	--			
COMP_D2	--	--	--	0.519* (0.038) 13.756	--	--			
COMP_E1	--	--	--	--	0.619* (0.047) 13.099	--			
COMP_E2	--	--	--	--	0.703* (0.053) 13.222	--			
COMP_F1	--	--	--	--	--	0.540* (0.053) 10.250			
COMP_F2	--	--	--	--	--	0.441* (0.051) 8.590			
COMP_G1							0.558* (0.047) 11.952	--	--
COMP_G2							0.595* (0.045) 13.185	--	--
COMP_H1							--	0.654* (0.053) 12.419	--
COMP_H2							--	0.653* (0.049) 13.211	--
COMP_I1							--	--	0.645* (0.047) 13.812
COMP_I2							--	--	0.595* (0.045) 13.117

\*(p &lt; .05)

Note: Comp\_A1 and Comp\_A2 refer to the two item parcels operationalising the *displays personal leader proficiency* latent variable (COMP\_A); Comp\_B1 and Comp\_B2 refer to the two item parcels operationalising the *analyses and understands the external and internal work unit environment* variable (COMP\_B); Comp\_C1 and Comp\_C2 refer to the two item parcels operationalising the *creates an exciting and aspirational vision for the unit* latent variable (COMP\_C); Comp\_D1 and Comp\_D2 refer to the two item parcels operationalising the *entrenches a high-performance culture in the unit* latent variable (COMP\_D); Comp\_E1 and Comp\_E2 refer to the two item parcels operationalising the *develops unit competitiveness* latent variable (COMP\_E); Comp\_F1 and Comp\_F2 refer to the two item parcels operationalising the *Involves others and elicits participation* latent variable (COMP\_F); Comp\_G1 and Comp\_G2 refer to the two item parcels operationalising the *unites and connects followers* latent variable (COMP\_G); Comp\_H1 and Comp\_H2 refer to the two item parcels operationalising the *strengthens and enables followers* latent variable (COMP\_H); and Comp\_I1 and Comp\_I2 refer to the two item parcels operationalising the *manages the internal work unit environment* latent variable (COMP\_I).

Table 5.96

*Completely standardised lambda-X matrix for the PGLCQ competency questionnaire measurement model*

	COMP_A	COMP_B	COMP_C	COMP_D	COMP_E	COMP_F	COMP_G	COMP_H	COMP_I
COMP_A1	.780	--	--	--	--	--	--	--	--
COMP_A2	.960	--	--	--	--	--	--	--	--
COMP_B1	--	.899	--	--	--	--	--	--	--
COMP_B2	--	.913	--	--	--	--	--	--	--
COMP_C1	--	--	.939	--	--	--	--	--	--
COMP_C2	--	--	.926	--	--	--	--	--	--
COMP_D1	--	--	--	.916	--	--	--	--	--
COMP_D2	--	--	--	.887	--	--	--	--	--
COMP_E1	--	--	--	--	.944	--	--	--	--
COMP_E2	--	--	--	--	.909	--	--	--	--
COMP_F1	--	--	--	--	--	.879	--	--	--
COMP_F2	--	--	--	--	--	.808	--	--	--
COMP_G1	--	--	--	--	--	--	.900	--	--
COMP_G2	--	--	--	--	--	--	.878	--	--
COMP_H1	--	--	--	--	--	--	--	.914	--
COMP_H2	--	--	--	--	--	--	--	.945	--
COMP_I1	--	--	--	--	--	--	--	--	.955
COMP_I2	--	--	--	--	--	--	--	--	.921

Note: Comp\_A1 and Comp\_A2 refer to the two item parcels operationalising the *displays personal leader proficiency* latent variable (COMP\_A); Comp\_B1 and Comp\_B2 refer to the two item parcels operationalising the *analyses and understands the external and internal work unit environment* variable (COMP\_B); Comp\_C1 and Comp\_C2 refer to the two item parcels operationalising the *creates an exciting and aspirational vision for the unit* latent variable (COMP\_C); Comp\_D1 and Comp\_D2 refer to the two item parcels operationalising the *entrenches a high-performance culture in the unit* latent variable (COMP\_D); Comp\_E1 and Comp\_E2 refer to the two item parcels operationalising the *develops unit competitiveness* latent variable (COMP\_E); Comp\_F1 and Comp\_F2 refer to the two item parcels operationalising the *Involves others and elicits participation* latent variable (COMP\_F); Comp\_G1 and Comp\_G2 refer to the two item parcels operationalising the *unites and connects followers* latent variable (COMP\_G); Comp\_H1 and Comp\_H2 refer to the two item parcels operationalising the *strengthens and enables followers* latent variable (COMP\_H); and Comp\_I1 and Comp\_I2 refer to the two item parcels operationalising the *manages the internal work unit environment* latent variable (COMP\_I).

Inspection of the unstandardised lambda-X matrix (Table 5.95) revealed that all the factor loading estimates were statistically significant ( $p < .05$ ), thus providing preliminary evidence in support of operational hypothesis 2.  $H_{0i}: \lambda_{jk} = 0$  were therefore rejected for all  $i = 3, 4, \dots, 20$ , all  $j = 1, 2, \dots, 18$  and all  $k = 1, 2, \dots, 9$  in favour of  $H_{ai}: \lambda_{jk} > 0$ ;  $i=3, 4, \dots, 20$ ;  $j=1, 2, \dots, 18$ ;  $k=1, 2, \dots, 9$ .

Furthermore, inspection of the completely standardised lambda-X matrix revealed factor loadings that ranged between .780 and .960, and that no inadmissible values were returned. Thus, all item parcels loaded satisfactorily ( $\lambda_{ij} \geq .78$ ) onto the latent variables they were earmarked to reflect. On average one standard deviation increase in a latent graduate leader competency was therefore associated with .78 of a standard deviation increase (or more up to .96 of a standard deviation) in the item parcel score. The item parcels therefore discriminated quite well between relatively small differences in standing on the latent graduate leader competencies. What is, however, to some degree disconcerting, is the question as to whether some items that are relatively less discriminatory might not be hiding in the item parcels, avoiding detection in the CFA. The fact that no seriously problematic items were flagged during the item analyses (or the dimensionality analyses), is a bit reassuring. Nonetheless, the item analyses (and dimensionality analyses) were performed for each subscale in isolation. The CFA evaluates the indicators when taking the correlation between the latent graduate leader competencies and measurement error into account. The methodological ideal would therefore have been to evaluate the discriminatory ability of the individual items via a CFA.

As all of the factor loadings surpassed the cut-off value set for operational hypothesis 2 ( $\lambda_{ij} \geq .71$ ) and were found to be statistically significant ( $p < .05$ ), all of the conditions set for operational hypothesis 2 were considered satisfied.

Finally, Table 5.97 below presents the  $R^2$  values calculated for the item parcels of the PGLCQ measurement model.

Table 5.97

*R<sup>2</sup> values for the items parcels of the PGLCQ measurement model*

COMP_A1	COMP_A2	COMP_B1	COMP_B2	COMP_C1	COMP_C2
.609	.902	.807	.833	.882	.857
COMP_D1	COMP_D2	COMP_E1	COMP_E2	COMP_F1	COMP_F2
0.839	.787	0.891	.827	.773	.653
COMP_G1	COMP_G2	COMP_H1	COMP_H2	COMP_I1	COMP_I2
.811	.771	.835	.839	.913	.849

Note: Comp\_A1 and Comp\_A2 refer to the two item parcels operationalising the *displays personal leader proficiency* latent variable (COMP\_A); Comp\_B1 and Comp\_B2 refer to the two item parcels operationalising the *analyses and understands the external and internal work unit environment* variable (COMP\_B); Comp\_C1 and Comp\_C2 refer to the two item parcels operationalising the *creates an exciting and aspirational vision for the unit* latent variable (COMP\_C); Comp\_D1 and Comp\_D2 refer to the two item parcels operationalising the *entrenches a high-performance culture in the unit* latent variable (COMP\_D); Comp\_E1 and Comp\_E2 refer to the two item parcels operationalising the *develops unit competitiveness* latent variable (COMP\_E); Comp\_F1 and Comp\_F2 refer to the two item parcels operationalising the *Involves others and elicits participation* latent variable (COMP\_F); Comp\_G1 and Comp\_G2 refer to the two item parcels operationalising the *unites and connects followers* latent variable (COMP\_G); Comp\_H1 and Comp\_H2 refer to the two item parcels operationalising the *strengthens and enables followers* latent variable (COMP\_H); and Comp\_I1 and Comp\_I2 refer to the two item parcels operationalising the *manages the internal work unit environment* latent variable (COMP\_I).

The R<sup>2</sup> estimates, in turn, were interpreted against the following hypothesis:

- **Operational hypothesis 3:** The graduate leader (second-order) competencies duly explain large proportions (i.e. > .50) of the variance in the item parcels that represent them respectively;

The R<sup>2</sup> values indicate the amount of variance in the indicator variables accounted for by the latent variable(s) linked to it in the measurement model. As shown in Table 5.97, the magnitude of the respective R<sup>2</sup> values obtained for the item parcels of the PGLCQ measurement model ranged between .609 and .913. This suggested that more than 60% of the variance (and more than 70% in the majority of the item parcels) could be explained by the latent variables they were designed to reflect. Therefore, as all factor loadings was found to be large,<sup>347</sup> the conditions set for operational hypothesis 3 were considered satisfied.

### 5.6.7.2 The measurement error variance-covariance (Theta-delta) matrix

The theta-delta matrix for the PGLCQ competency questionnaire measurement model was inspected essentially to test the following hypothesis:

- **Operational hypothesis 4:** The measurement error variances associated with each item parcel are statistically significant ( $p < .05$ ) yet small ( $\theta_{\delta ii} \leq .50$ ).

Operational hypothesis 4 was tested by testing the following 18 null hypotheses on the freed elements in the variance-covariance matrix  $\Theta_{\delta}$ :

$$H_{0i}: \theta_{\delta ij} = 0; i = 21, 22, \dots, 38; j = 1, 2, \dots, 18$$

$$H_{a1}: \theta_{\delta ij} > 0; i = 21, 22, \dots, 38; j = 1, 2, \dots, 18$$

The unstandardised and standardised measurement error variances for the item parcels constructed for the PGLCQ measurement model are shown in Tables 5.98 and 5.99 below.

<sup>347</sup> Cohen (1988; 1992) suggests the following guidelines for the interpretation of effect sizes in the social sciences: Small ( $r = 0.10$ ); Medium ( $r = 0.30$ ); Large ( $r = 0.50$ ), while Hair, Black Babin, Anderson and Tatham (2006) recommend a more lenient cut-off value of 0.40.



Table 5.98

*Unstandardised measurement error variance-covariance (theta-delta) matrix for the PGLCQ measurement model*

COMP_A1	COMP_A2	COMP_B1	COMP_B2	COMP_C1	COMP_C2
0.145*	0.028	0.082*	0.091*	0.062*	0.072*
(0.040)	(0.025)	(0.017)	(0.023)	(0.015)	(0.018)
3.591	1.132	4.747	3.997	4.021	4.000
COMP_D1	COMP_D2	COMP_E1	COMP_E2	COMP_F1	COMP_F2
0.064*	0.073*	0.047*	0.104*	0.086*	0.103*
(0.017)	(0.013)	(0.017)	(0.022)	(0.021)	(0.018)
3.826	5.429	2.818	4.813	4.037	5.757
COMP_G1	COMP_G2	COMP_H1	COMP_H2	COMP_I1*	COMP_I2
0.073*	0.105*	0.085*	0.051*	0.040	0.595*
(0.020)	(0.020)	(0.014)	(0.012)	(0.015)	(0.045)
3.696	5.316	5.985	4.123	2.747	13.117

\*p &lt; .05

Note: Comp\_A1 and Comp\_A2 refer to the two item parcels operationalising the *displays personal leader proficiency* latent variable (COMP\_A); Comp\_B1 and Comp\_B2 refer to the two item parcels operationalising the *analyses and understands the external and internal work unit environment* variable (COMP\_B); Comp\_C1 and Comp\_C2 refer to the two item parcels operationalising the *creates an exciting and aspirational vision for the unit* latent variable (COMP\_C); Comp\_D1 and Comp\_D2 refer to the two item parcels operationalising the *entrenches a high-performance culture in the unit* latent variable (COMP\_D); Comp\_E1 and Comp\_E2 refer to the two item parcels operationalising the *develops unit competitiveness* latent variable (COMP\_E); Comp\_F1 and Comp\_F2 refer to the two item parcels operationalising the *Involves others and elicits participation* latent variable (COMP\_F); Comp\_G1 and Comp\_G2 refer to the two item parcels operationalising the *unites and connects followers* latent variable (COMP\_G); Comp\_H1 and Comp\_H2 refer to the two item parcels operationalising the *strengthens and enables followers* latent variable (COMP\_H); and Comp\_I1 and Comp\_I2 refer to the two item parcels operationalising the *manages the internal work unit environment* latent variable (COMP\_I).

As can be deduced from Table 5.98 above, measurement error variances for the PGLCQ measurement model were found to be statistically significant (i.e. all z scores surpassed the 1.6449 threshold;  $p < .05$ ) for virtually all of the item parcels. Comp\_A2 was the only item parcel that did not deliver a statistically significant ( $p < .05$ ) measurement error variance estimate. Error variance is not a desirable feature of psychological measures. Nonetheless, a finding of a statistically insignificant ( $p > .05$ ) measurement error variance estimate is disconcerting in that it allows for a position that is simply too good to be true. In the sample, the measurement error variance estimate for Comp\_A2 is positive, albeit small. The finding is disturbing in that the magnitude of the sample measurement error variance estimate does not allow one to rule out that the sample estimate was simply due to sampling error under  $H_{0i}$ :  $\theta_{\delta 22} = 0$  and that the null hypothesis, therefore, cannot be rejected as a plausible scenario in the parameter.  $H_{0i}$ :  $\theta_{\delta jj} = 0$  were therefore rejected for ;  $i = 21, 23, \dots, 38$  and  $j = 1, 3, \dots, 18$  in favour of  $H_{ai}$ :  $\theta_{\delta jj} > 0$ ;  $i = 21, 23, \dots, 38$ ;  $j = 1, 3, \dots, 18$ .  $H_{022}$ :  $\theta_{\delta 22} = 0$  was not rejected.

Table 5.99

*Completely standardised theta-delta matrix for the PGLCQ competency questionnaire measurement model*

COMP_A1	COMP_A2	COMP_B1	COMP_B2	COMP_C1	COMP_C2
.391	.078	.193	.167	.118	.143
COMP_D1	COMP_D2	COMP_E1	COMP_E2	COMP_F1	COMP_F2
0.161	.213	.109	.173	.227	.347
COMP_G1	COMP_G2	COMP_H1	COMP_H2	COMP_I1	COMP_I2
.189	.229	.165	.107	.087	.151

Note: Comp\_A1 and Comp\_A2 refer to the two item parcels operationalising the *displays personal leader proficiency* latent variable (COMP\_A); Comp\_B1 and Comp\_B2 refer to the two item parcels operationalising the *analyses and understands the external and internal work unit environment* variable (COMP\_B); Comp\_C1 and Comp\_C2 refer to the two item parcels operationalising the *creates an exciting and aspirational vision for the unit* latent variable (COMP\_C); Comp\_D1 and Comp\_D2 refer to the two item parcels operationalising the *entrenches a high-performance culture in the unit* latent variable (COMP\_D); Comp\_E1 and Comp\_E2 refer to the two item parcels operationalising the *develops unit competitiveness* latent variable (COMP\_E); Comp\_F1 and Comp\_F2 refer to the two item parcels operationalising the *Involves others and elicits participation* latent variable (COMP\_F); Comp\_G1 and Comp\_G2 refer to the two item parcels operationalising the *unites and connects followers* latent variable (COMP\_G); Comp\_H1 and Comp\_H2 refer to the two item parcels operationalising the *strengthens and enables followers* latent variable (COMP\_H); and Comp\_I1 and Comp\_I2 refer to the two item parcels operationalising the *manages the internal work unit environment* latent variable (COMP\_I).

Furthermore, measurement error variance for all item parcels ranged between .078 and .391. In practical terms, this meant that measurement error accounted for between 7.8% and 39% of the variance in all of the PGLCQ item parcels. As the measurement error variance associated with (virtually) all item parcels were found to be statistically significant, and sufficiently small ( $\theta_{\delta ii} \leq .50$ ), all of the conditions for operational hypothesis 4 was considered satisfied as well.

### 5.6.8 THE DISCRIMINANT VALIDITY OF THE PGLCQ

The  $\Phi$  matrix was interpreted to test the following operational hypothesis:

- Operational hypothesis 5: The graduate leader (second-order) competencies correlate statistically significantly ( $p < .05$ ) while not excessively highly with each other ( $\phi_{ij} < .90$ ), providing evidence of *discriminant validity*.

Operational hypothesis 5 was tested by testing the following 36 null hypotheses with regard to the freed elements in the variance-covariance matrix  $\Phi$ :

$H_{0i}: \phi_{kp} = 0; i = 39, 40, \dots, 74; k = 1, 2, \dots, 9; p = 1, 2, \dots, 9; j \neq k$

$H_{ai}: \phi_{kp} > 0; i = 39, 40, \dots, 74; k = 1, 2, \dots, 9; p = 1, 2, \dots, 9; j \neq k$

The nine latent graduate leader competencies as defined by the PGLCQ were expected to correlate with each other to some extent because they were assumed to gravitate together within the same nomological network of the graduate leader performance space. However, since these nine competencies were designed essentially to constitute nine qualitatively distinct, yet related dimensions of graduate leader performance they should, nevertheless, not have correlated excessively highly with one another in the parameter. If this was indeed the case, then it would have been apparent that the item parcels used in the analysis functioned inappropriately and the conclusions made regarding the relationships between latent competency dimensions could therefore be brought into question. The latent variable intercorrelations for the PGLCQ measurement model are shown in the phi matrix output as per Table 5.100 below.

It is evident from Table 5.100 that all of the intercorrelations between the PGLCQ competency latent variables were statistically significant ( $p < .05$ ).  $H_{0i}: \phi_{kp} = 0$  were therefore rejected for all  $i = 39, 40, \dots, 74$ , all  $k = 1, 2, \dots, 9$  and all  $p = 1, 2, \dots, 9$  ( $j \neq k$ ) in favour of  $H_{ai}: \phi_{kp} > 0; i = 39, 40, \dots, 74; k = 1, 2, \dots, 9; p = 1, 2, \dots, 9; j \neq k$ . Moreover, as judged by an inspection of the magnitude of the values in the phi matrix, the researcher concluded that none of the intercorrelations between the competency variables were excessively high. This conclusion was warranted, as all intercorrelations gravitated between the range of .65 and .75 and ultimately, only five of the 36 intercorrelation values exceeded the .80 mark (14%), which was regarded as acceptable and still below the current study's set cut-off of .90. In the validation sample the worst degree of overlap occurred between Comp\_D (*entrenches a high-performance culture in the unit*) and Comp\_H (*strengthens and enables followers*) with  $.836^2 = .699$  shared variance. However, the absence of excessive intercorrelations between the PGLCQ latent competency variables in the phi matrix still did not provide strong enough evidence to support the claim of discriminant validity for the PGLCQ by itself. There still existed the possibility that the latent competency dimensions actually correlated unity in the parameter, but that this was possibly masked by sampling error.

For this reason, the researcher decided to supplement the phi-matrix analysis above with two additional tests of discriminant validity. The first supplementary test for discriminant validity involved the calculation of the thirty-six 95% confidence intervals for  $\phi_{iq}$  using an Excel macro developed by Scientific Software International (Mels, 2010) and to assess whether any of the 95% confidence intervals included unity. Thus, the hope was that none of the confidence intervals would include the value 1, as this would imply that the null hypothesis  $H_{0i}: \phi_{iq} = 1$  (or  $H_{0i}: \rho_{iq} = 0$ )

could not be rejected and any confidence in the claim that the PGLCQ latent competency dimensions were measured as unique and qualitatively distinct from each other could be brought into question. The 95% confident intervals that were calculated for the purpose of testing the discriminant validity of the PGLCQ are presented in Table 5.101.

The second, more stringent, supplementary test of discriminant validity was to determine whether the average variance extracted (AVE) for each construct was greater than its shared variance with other constructs, where shared variance represented the amount of variance that one construct or latent variable was able to explain in another construct or latent variable (Farrell & Rudd, 2009). In this regard, the hope was therefore that the AVE<sup>348</sup> for each of the possible pairs of latent competency dimensions would be greater than the squared correlations between the latent variables, and that the AVE for each latent competency dimensions would be greater than .50 (Fornell & Larcker, 1981). The AVE and  $\phi_{iq}$  calculations are shown in Table 5.102.

---

<sup>348</sup> The AVE was calculated by using a prepopulated Excel macro and the formula:  $\rho_v = (\sum \lambda^2_{ij}) / (\sum \lambda^2_{ij} + \sum \theta_{\delta i})$  (Diamantopoulos & Siguaw, 2000, p. 91).

Table 5.100

*Phi matrix for the PGLCQ competency questionnaire measurement model*

	COMP_A	COMP_B	COMP_C	COMP_D	COMP_E	COMP_F	COMP_G	COMP_H	COMP_I
COMP_A	1.000								
	--								
	--								
COMP_B	.721*	1.000							
	(0.084)	--							
	8.552	--							
COMP_C	.751*	.799*	1.000						
	(0.061)	(0.062)	--						
	12.275	17.075	--						
COMP_D	.652*	.697*	<b>.805*</b>	1.000					
	(0.075)	(0.062)	(0.047)	--					
	8.643	11.207	17.289	--					
COMP_E	.625*	.710*	.733*	.578*	1.000				
	(0.067)	(0.063)	(0.058)	(0.071)	--				
	9.371	11.302	12.634	8.194	--				
COMP_F	.647*	.762*	.709*	.778*	.624*	1.000			
	(0.075)	(0.055)	(0.071)	(0.052)	(0.072)	--			
	8.640	13.909	9.960	14.921	8.637	--			
COMP_G	.675*	.643*	.769*	.764*	.592*	<b>.812*</b>	1.000		
	(0.058)	(0.078)	(0.047)	(0.071)	(0.066)	(0.047)	--		
	11.540	8.206	16.234	10.791	8.919	17.093	--		
COMP_H	.768*	.737*	<b>.815*</b>	<b>.836*</b>	.685*	<b>.803*</b>	.781*	1.000	
	(0.054)	(0.076)	(0.047)	(0.045)	(0.064)	(0.047)	(0.065)	--	
	14.114	9.694	17.167	18.560	10.663	17.142	12.061	--	
COMP_I	.716*	.740*	.782*	.683*	.781*	.663*	.735*	.758*	1.000
	(0.058)	(0.054)	(0.041)	(0.062)	(0.045)	(0.064)	(0.052)	(0.061)	--
	12.238	13.644	19.013	10.962	17.181	10.387	14.134	12.351	--

\*p &lt; .05

Note: Comp\_A1 and Comp\_A2 refer to the two item parcels operationalising the *displays personal leader proficiency* latent variable (COMP\_A); Comp\_B1 and Comp\_B2 refer to the two item parcels operationalising the *analyses and understands the external and internal work unit environment* variable (COMP\_B); Comp\_C1 and Comp\_C2 refer to the two item parcels operationalising the *creates an exciting and aspirational vision for the unit* latent variable (COMP\_C); Comp\_D1 and Comp\_D2 refer to the two item parcels operationalising the *entrenches a high-performance culture in the unit* latent variable (COMP\_D); Comp\_E1 and Comp\_E2 refer to the two item parcels operationalising the *develops unit competitiveness* latent variable (COMP\_E); Comp\_F1 and Comp\_F2 refer to the two item parcels operationalising the *Involves others and elicits participation* latent variable (COMP\_F); Comp\_G1 and Comp\_G2 refer to the two item parcels operationalising the *unites and connects followers* latent variable (COMP\_G); Comp\_H1 and Comp\_H2 refer to the two item parcels operationalising the *strengthens and enables followers* latent variable (COMP\_H); and Comp\_I1 and Comp\_I2 refer to the two item parcels operationalising the *manages the internal work unit environment* latent variable (COMP\_I). Values in bold are  $\phi_{iq}$  values greater than .80.

Table 5.101

*95% confidence interval for sample phi estimates*

	COMP_A	COMP_B	COMP_C	COMP_D	COMP_E	COMP_F	COMP_G	COMP_H	COM_PI
COMP_A	--								
COMP_B	.513-.849	--							
COMP_C	.605-.848	.686-.874	--						
COMP_D	.480-.776	.555-.800	.692-.880	--					
COMP_E	.476-.739	.697-.722	.598-.828	.422-.701	--				
COMP_F	.476-.771	.631-.851	.541-.823	.654-.861	.462-.745	--			
COMP_G	.545-.773	.464-.771	.660-.846	.586-.872	.448-.706	.698-.886	--		
COMP_H	.640-.855	.550-.854	.700-.889	.723-.905	.539-.791	.690-.878	.618-.880	--	
COMP_I	.582-.812	.615-.829	.688-.850	.0542-.787	.676-.855	.519-.771	.616-.821	.611-.854	--

Note: Comp\_A1 and Comp\_A2 refer to the two item parcels operationalising the *displays personal leader proficiency* latent variable (COMP\_A); Comp\_B1 and Comp\_B2 refer to the two item parcels operationalising the *analyses and understands the external and internal work unit environment* variable (COMP\_B); Comp\_C1 and Comp\_C2 refer to the two item parcels operationalising the *creates an exciting and aspirational vision for the unit* latent variable (COMP\_C); Comp\_D1 and Comp\_D2 refer to the two item parcels operationalising the *entrenches a high-performance culture in the unit* latent variable (COMP\_D); Comp\_E1 and Comp\_E2 refer to the two item parcels operationalising the *develops unit competitiveness* latent variable (COMP\_E); Comp\_F1 and Comp\_F2 refer to the two item parcels operationalising the *Involves others and elicits participation* latent variable (COMP\_F); Comp\_G1 and Comp\_G2 refer to the two item parcels operationalising the *unites and connects followers* latent variable (COMP\_G); Comp\_H1 and Comp\_H2 refer to the two item parcels operationalising the *strengthens and enables followers* latent variable (COMP\_H); and Comp\_I1 and Comp\_I2 refer to the two item parcels operationalising the *manages the internal work unit environment* latent variable (COMP\_I).

Table 5.102

*Squared sample phi estimates and average variance extracted per latent variable*

	COMP_A	COMP_B	COMP_C	COMP_D	COMP_E	COMP_F	COMP_G	COMP_H	COM_PI	AVE
COMP_A	1									.763
COMP_B	.519	1								.821
COMP_C	.564	.638	1							.869
COMP_D	.425	.485	.648	1						.814
COMP_E	.390	.504	.537	.334	1					.853
COMP_F	.418	.580	.502	.605	.389	1				.720
COMP_G	.455	.413	.591	.583	.350	.659	1			.788
COMP_H	.589	.543	.664	.698	.469	.644	.609	1		.862
COMP_I	.512	.547	.611	.466	.609	.439	.540	.574	1	.882
AVE	.763	.821	.869	.814	.853	.720	.788	.862	.882	

Note: Comp\_A1 and Comp\_A2 refer to the two item parcels operationalising the *displays personal leader proficiency* latent variable (COMP\_A); Comp\_B1 and Comp\_B2 refer to the two item parcels operationalising the *analyses and understands the external and internal work unit environment* variable (COMP\_B); Comp\_C1 and Comp\_C2 refer to the two item parcels operationalising the *creates an exciting and aspirational vision for the unit* latent variable (COMP\_C); Comp\_D1 and Comp\_D2 refer to the two item parcels operationalising the *entrenches a high-performance culture in the unit* latent variable (COMP\_D); Comp\_E1 and Comp\_E2 refer to the two item parcels operationalising the *develops unit competitiveness* latent variable (COMP\_E); Comp\_F1 and Comp\_F2 refer to the two item parcels operationalising the *Involves others and elicits participation* latent variable (COMP\_F); Comp\_G1 and Comp\_G2 refer to the two item parcels operationalising the *unites and connects followers* latent variable (COMP\_G); Comp\_H1 and Comp\_H2 refer to the two item parcels operationalising the *strengthens and enables followers* latent variable (COMP\_H); and Comp\_I1 and Comp\_I2 refer to the two item parcels operationalising the *manages the internal work unit environment* latent variable (COMP\_I).

As can be seen from Tables 5.101 and 5.102, both sets of criteria for the second supplementary test of discriminant validity were realised. The AVE values for all of the latent competency dimensions surpassed the .50 cut-off and were also found to be larger than the squared correlations between the latent competency dimensions. This finding suggested that the item parcels of each latent competency dimension captured the distinctions between the latent variables measured by the PGLCQ successfully. Furthermore, it is apparent from Table 5.101 that none of the 36 confidence intervals included unity. This finding, in turn, bolstered confidence (in terms of sampling error) in the discriminant validity with which the PGLCQ was able to measure the nine latent graduate leader competencies. Given the totality of these results (i.e. competencies correlated statistically significantly ( $p < .05$ ), yet low to moderately with each other ( $\phi_{iq} < .90$ ), the extracted AVE values were greater than .50 and greater than the squared correlation between the latent competency dimensions, and that none of the calculated 95% confidence intervals included unity), the researcher therefore considered all of the conditions for operational hypothesis 5 (i.e. discriminant validity for the PGLCQ) to be satisfied as well.

## **5.7 PSYCHOMETRIC EVALUATION OF THE COMPREHENSIVE GRADUATE LEADER PERFORMANCE LISREL MODEL**

### **5.7.1 INTRODUCTION**

The *graduate leader performance* construct (interpreted behaviourally) was initially conceptualised as a construct comprising nine second-order latent competencies. In conceptualising the connotative meaning of the construct, the identity of nine latent competency dimensions was explicated as well as the manner in which these were understood to influence each other (directly and indirectly) as part of a nomological network believed to constitute graduate leader performance. Consequently, the PGLCQ was developed by designing specific test stimuli for each latent competency dimension in such a way as to make the manner in which respondents responded to the test stimuli representative of their standing on each latent competency dimension. Moreover, in the previous section, it was shown that the PGLCQ measurement model demonstrated close fit in the parameter and returned favourable parameter estimates, which tended to support the claim that the construct-referenced inferences derived from the PGLCQ dimension scores on graduate leaders' standing on the *graduate leader performance* construct are construct valid. However, this demonstration of close fit along with the favourable parameter estimates (i.e. that the PGLCQ was able to validly and reliably measure the nine latent competency dimensions), still did not constitute sufficient evidence to fully support the claim that the measures of the PGLCQ of the *graduate leader performance construct* are construct valid.

In order to comprehensively demonstrate that the PGLCQ reflects the *graduate leader performance* construct as connotatively defined, the structural relations that were assumed to constitute the internal structure of the construct still needed to be empirically demonstrated after the latent competency dimensions that the construct comprises of had been measured through the PGLCQ. And it was only when the structural part of the graduate leader performance comprehensive LISREL model was evaluated that evidence could be collected regarding the relationships between the latent competency dimensions (i.e. the hypothesised structural linkages between the endogenous and exogenous latent variables in the structural model) in order to support or reject its proposed underlying connotative definition/structure. If the PGLCQ validly measured the *graduate leader performance* construct as connotatively defined, a structural model reflecting the attributed internal structure should fit the (item parcel) data obtained on the PGLCQ and the structural paths hypothesised to exist between the latent graduate leader competencies should be statistically significant ( $p < .05$ ). The testing of the *graduate leader performance* comprehensive LISREL model therefore essentially related to the following hypothesis as formulated in Chapter 3:

- Hypothesis 1b: The structural model implied by the connotative meaning of the graduate leadership performance construct (interpreted behaviourally) as expressed by the internal structure assigned to the construct taken in conjunction with the design intent of the PGLCQ provides a valid account of the psychological processes underpinning the level of performance that graduates attain on the behavioural components of the graduate leader job performance construct (i.e. on the second-order graduate leader competencies). This hypothesis was, in turn, translated into the following operational hypothesis:
  - Operational hypothesis 6: The competency domain structural model implied by the manner in which the constitutive definition of the graduate leader behavioural performance construct embeds (second-order) competencies in a nomological network of latent variables as described in Chapter 2 can closely reproduce the covariances observed between item parcels<sup>349</sup> calculated from the items comprising each of the PGLCQ subscales; and
  - Operational hypothesis 7: The slope of the regression of  $\eta_j$  on  $\xi_i$  and the regression of  $\eta_j$  on  $\eta_i$  in the structural model implied by the manner in which the constitutive definition of the graduate leader behavioural performance construct embeds competencies in a nomological network of latent variables are statistically significant ( $p < .05$ ). Operational hypothesis 7 thus implies the testing of 18 path-specific substantive hypotheses:
    - Path-specific substantive hypothesis 1: In the proposed graduate leadership@work competency domain structural model<sup>350</sup> it is hypothesised that a high level of personal leader proficiency ( $\xi_1$ ) will improve leadership effectiveness in entrenching a high-performance culture in the unit ( $\eta_1$ );
    - Path-specific substantive hypothesis 2: In the proposed graduate leadership@work competency domain structural model it is hypothesised that a high level of personal leader proficiency ( $\xi_1$ ) will improve leadership effectiveness in creating an exciting and aspirational vision ( $\eta_2$ );
    - Path-specific substantive hypothesis 3: In the proposed graduate leadership@work competency domain structural model it is hypothesised that a high level of personal leader proficiency ( $\xi_1$ ) will improve leadership effectiveness in analysing and understanding the external and internal work unit environment ( $\eta_3$ );
    - Path-specific substantive hypothesis 4: In the proposed graduate leadership@work competency domain structural model it is hypothesised that a high level of personal leader proficiency ( $\xi_1$ ) will improve leadership effectiveness in the development of unit competitiveness ( $\eta_4$ );
    - Path-specific substantive hypothesis 5: In the proposed graduate leadership@work competency domain structural model it is hypothesised that a high level of personal leader proficiency ( $\xi_1$ ) will improve leadership effectiveness in the management of the unit's internal environment ( $\eta_5$ );
    - Path-specific substantive hypothesis 6: In the proposed graduate leadership@work competency domain structural model it is hypothesised that high proficiency on the entrenchment of a high-performance culture

<sup>349</sup> Note that this operational hypothesis was adapted from Chapter 3 to incorporate the fact that item parcels were eventually used to fit the comprehensive PGLCQ structural model.

<sup>350</sup> The phrase *in the proposed graduate leadership@work competency domain structural model* is used on purpose to reflect the fact that  $\gamma_{ij}$  and  $\beta_{ij}$  represent partial regression coefficients that reflect the average change in  $\eta_i$  associated with one unit change in  $\xi_j$  or  $\eta_j$  when controlling for the other latent variables in the structural equation of  $\eta_i$ .

- ( $\eta_1$ ) will improve leadership effectiveness in strengthening and enabling followers ( $\eta_7$ );
- Path-specific substantive hypothesis 7: In the proposed graduate leadership@work competency domain structural model it is hypothesised that high proficiency on the entrenchment of a high-performance culture ( $\eta_1$ ) will improve leadership effectiveness in uniting and connecting followers ( $\eta_6$ );
  - Path-specific substantive hypothesis 8: In the proposed graduate leadership@work competency domain structural model it is hypothesised that high proficiency on the entrenchment of a high-performance culture ( $\eta_1$ ) will improve leadership effectiveness in involving others and eliciting participation ( $\eta_5$ );
  - Path-specific substantive hypothesis 9: In the proposed graduate leadership@work competency domain structural model it is hypothesised that high proficiency on involving others and eliciting participation ( $\eta_5$ ) will improve leadership effectiveness in the development of unit competitiveness ( $\eta_4$ );
  - Path-specific substantive hypothesis 10: In the proposed graduate leadership@work competency domain structural model it is hypothesised that high proficiency on analysing and understanding the external and internal work unit environment ( $\eta_3$ ) will improve leadership effectiveness in developing the unit's competitiveness ( $\eta_4$ );
  - Path-specific substantive hypothesis 11: In the proposed graduate leadership@work competency domain structural model it is hypothesised that high proficiency on developing unit competitiveness ( $\eta_4$ ) will improve leadership effectiveness in managing the unit's internal environment ( $\eta_8$ );
  - Path-specific substantive hypothesis 12: In the proposed graduate leadership@work competency domain structural model it is hypothesised that high proficiency on strengthening and enabling followers ( $\eta_7$ ) will improve leadership effectiveness in managing the unit's internal environment ( $\eta_8$ );
  - Path-specific substantive hypothesis 13: In the proposed graduate leadership@work competency domain structural model it is hypothesised that high proficiency on uniting and connecting followers ( $\eta_6$ ) will improve leadership effectiveness in managing the unit's internal environment ( $\eta_8$ );
  - Path-specific substantive hypothesis 14: In the proposed graduate leadership@work competency domain structural model it is hypothesised that high proficiency on involving others and eliciting participation ( $\eta_5$ ) will improve leadership effectiveness in managing the unit's internal environment ( $\eta_8$ );
  - Path-specific substantive hypothesis 15: In the proposed graduate leadership@work competency domain structural model it is hypothesised that high proficiency on the management of the unit's internal environment ( $\eta_8$ ) will improve leadership effectiveness in analysing and understanding the external and internal work unit environment ( $\eta_3$ );
  - Path-specific substantive hypothesis 16: In the proposed graduate leadership@work competency domain structural model it is hypothesised that high proficiency on analysing and understanding the external and internal work unit environment ( $\eta_3$ ) will improve leadership effectiveness in the creation of an exciting and aspirational vision ( $\eta_2$ );
  - Path-specific substantive hypothesis 17: In the proposed graduate leadership@work competency domain structural model it is hypothesised



- that high proficiency on the creation of an exciting and aspirational vision ( $\eta_2$ ) will improve leadership effectiveness in entrenching a high-performance culture in the unit ( $\eta_1$ );
- Pact-specific substantive hypothesis 18: In the proposed graduate leadership@work competency domain model it is hypothesised that high proficiency on the creation of an exciting and aspirational vision ( $\eta_2$ ) will improve leadership effectiveness in developing the unit's competitiveness ( $\eta_4$ ); and
  - Operational hypothesis 8: The structural error variances associated with each endogenous latent variable in the competency domain structural model are statistically significant ( $p < .05$ ) and large ( $\psi_{jj} \geq .70$ ).

In order to test the aforementioned operational hypotheses, the researcher conducted a further SEM analysis via LISREL 8.8 by utilising the same item parcels that were used in fitting the study's PGLCQ measurement model. Operational hypothesis 6 was tested by testing the following exact fit and close fit null hypotheses:

Exact fit:

$H_{075}$ : RMSEA = 0

$H_{a75}$ : RMSEA > 0

Close fit:

$H_{076}$ : RMSEA  $\leq$  .05

$H_{a76}$ : RMSEA > .05

The fit obtained for the *graduate leader performance* comprehensive LISREL model<sup>351</sup> will be discussed in the sections that follow. The discussion will unfold by way of an evaluation of the overall model fit based on an array of model fit indices reported by LISREL 8.8, an examination of the model's standardised residuals, an assessment of the structural relationships specified in the structural model, and an investigation into the statistical significance and magnitude of the structural error variance estimates.

## 5.8 EXAMINING THE FIT OF THE COMPREHENSIVE GRADUATE LEADER PERFORMANCE LISREL MODEL

Table 5.103 depicts the full array of fit statistics calculated by LISREL 8.8 to assess the fit of the graduate leader performance comprehensive LISREL model. The completely standardised solution obtained when the comprehensive LISREL model was fitted (via RML) is depicted in Figure 5.19.

---

<sup>351</sup> The structural model, describing the hypothesised structural relations between the latent graduate leader competencies, cannot be empirically tested in isolation. The fit of the structural model needs to be inferred from the fit of the comprehensive LISREL model and the fit of the measurement model (describing the structural relations between the latent graduate leader competencies and the indicator variables).

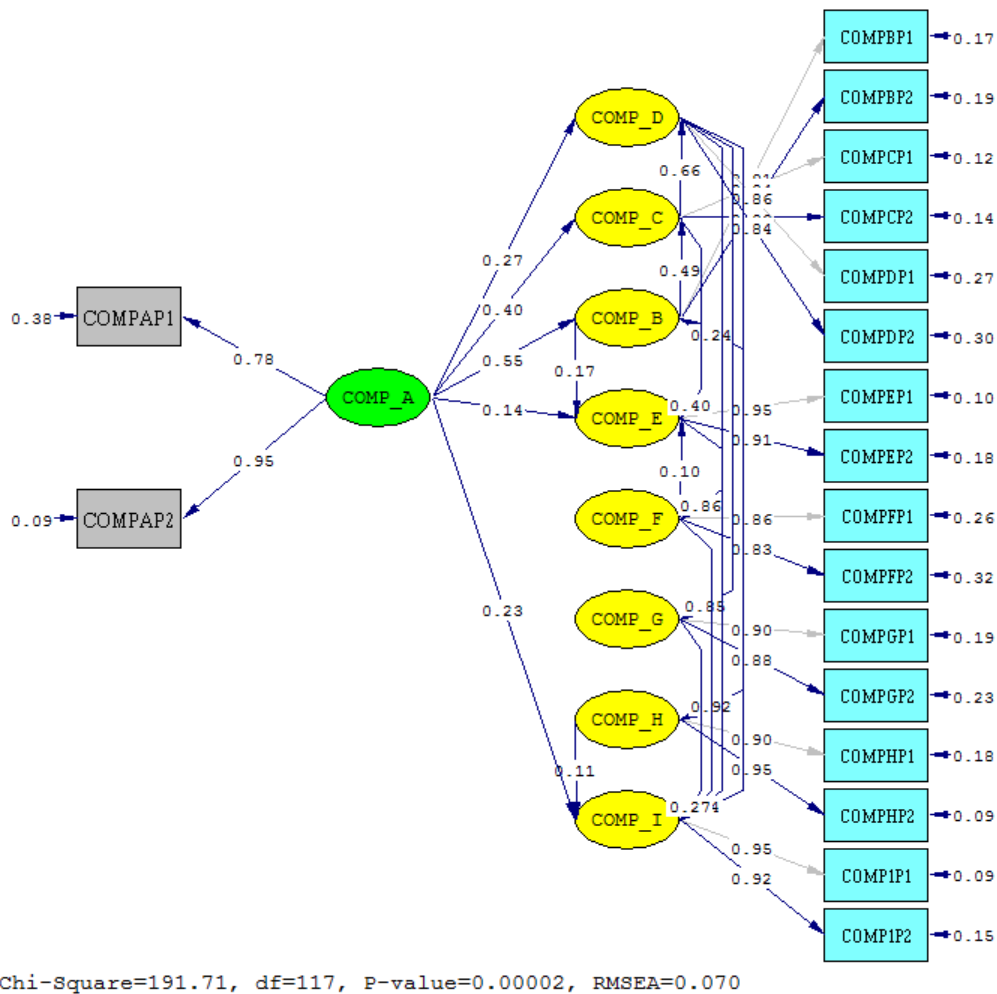

Figure 5.19. Representation of the comprehensive graduate leader performance LISREL model (completely standardised solution)

Table 5.103

*Basket of goodness of fit statistics for the comprehensive graduate leader performance LISREL model*

Goodness of Fit Statistics	
Degrees of Freedom = 117	
Minimum Fit Function Chi-Square = 212.572 (P = 0.000)	
Normal Theory Weighted Least Squares Chi-Square = 208.954 (P = 0.000)	
Satorra-Bentler Scaled Chi-Square = 191.705 (P = 0.000)	
Chi-Square Corrected for Non-Normality = 1637.788 (P = 0.0)	
Estimated Non-centrality Parameter (NCP) = 74.705	
90 Percent Confidence Interval for NCP = (40.636 ; 116.679)	
Minimum Fit Function Value = 1.610	
Population Discrepancy Function Value (F0) = 0.566	
90 Percent Confidence Interval for F0 = (0.308 ; 0.884)	
Root Mean Square Error of Approximation (RMSEA) = 0.0695	
90 Percent Confidence Interval for RMSEA = (0.0513 ; 0.0869)	
P-Value for Test of Close Fit (RMSEA < 0.05) = .0400	
Expected Cross-Validation Index (ECVI) = 2.270	
90 Percent Confidence Interval for ECVI = (2.012 ; 2.588)	
ECVI for Saturated Model = 2.591	
ECVI for Independence Model = 58.505	
Chi-Square for Independence Model with 153 Degrees of Freedom = 7686.711	
Independence AIC = 7722.711	

Table 5.103

*Basket of goodness-of-fit statistics for the comprehensive LISREL model (continued)*

Goodness of Fit Statistics
Model AIC = 299.705
Saturated AIC = 342.000
Independence CAIC = 7792.737
Model CAIC = 509.784
Saturated CAIC = 1007.250
Normed Fit Index (NFI) = .975
Non-Normed Fit Index (NNFI) = .987
Parsimony Normed Fit Index (PNFI) = .746
Comparative Fit Index (CFI) = .990
Incremental Fit Index (IFI) = .990
Relative Fit Index (RFI) = .967
Critical N (CN) = 108.068
Root Mean Square Residual (RMR) = .0171
Standardized RMR = .0401
Goodness of Fit Index (GFI) = .850
Adjusted Goodness of Fit Index (AGFI) = .781
Parsimony Goodness of Fit Index (PGFI) = .582

As can be seen from Table 5.103 above, LISREL calculates a plethora of indices that each has a specific capability unique to model fit evaluation. Some represent measures of parsimony, some compare model fit to a baseline model, while others focus on global fit or are based on minimum sample or population discrepancy. Together, these indices provide complimentary information (yet sometimes-conflicting results) about model fit.

### 5.8.1 ABSOLUTE FIT INDICES

Absolute fit indices do not rely on comparisons with other (baseline) models (Jöreskog & Sörbom, 1993) but instead provide a measure of the extent of the overall model-to-data fit for both structural and measurement models (Bollen, 1990; Hair et al, 1998). Most of these indices indicate “how far” a model is from perfect fit and as such, actually is indicative of *badness of fit* (Kline, 2005) in that larger index values indicate poorer fit. As part of its output, LISREL calculates a number of absolute fit indices including the Satorra-Bentler chi-square statistic, the Root mean square error of approximation (RMSEA), the Root mean square residual (RMR), the Standardised root mean square residual (SRMR), the Goodness of fit index (GFI), the Adjusted goodness of fit index (AGFI), the Critical N (CN) and the Expected cross-validation index (ECVI), all of which was used to evaluate the absolute fit of the graduate leader performance comprehensive LISREL model.

As can be seen from the output as per Table 5.103, the Satorra-Bentler chi-square delivered a statistically significant value ( $\chi^2 = 191.705$ ;  $p < .05$ ). The exact fit null hypothesis ( $H_{075}$ : RMSEA = 0) was therefore rejected and it was concluded that the comprehensive graduate leader performance LISREL model was not able to reproduce the observed covariance matrix to a degree of accuracy that could be explained in terms of sampling error alone. On the other hand, the RMSEA value (.069;  $p < .05$ ) indicated reasonable, approximate fit in the sample.<sup>352</sup> Nonetheless, the close fit null hypothesis ( $H_{076}$ : RMSEA  $\leq$  .05) also had to be rejected because even though the RMSEA value was only slightly larger than .05 (and therefore could be regarded as a minor deviation from the critical cut-off value for close fit in the sample), the probability of observing the same RMSEA value (or a lower value) in the sample if the close fit null hypothesis was true in the parameter, was not ( $p = .040$ ) sufficiently large enough not to question the close fit null

<sup>352</sup> Hu and Bentler (1999) suggest a critical cut-off value close to 0.6 while Steiger (2007) suggests that an upper limit of 0.07 can still be considered as good (or reasonable fit).

hypothesis. One of the greatest advantages of RMSEA, however, is that it allows for a confidence interval to be calculated around its value (MacCallum, Browne, & Sugawara, 1996) with which to test the null hypothesis of poor fit more precisely (McQuitty, 2004). In this regard, the 90% confidence interval is typically reported in conjunction with the RMSEA value and in a well-fitting model, the lower limit should be close to zero (but at least lower than .05), while the upper limit should ideally be less than .08 (Hooper, et al., 2008). An inspection of the 90 percent confidence interval for RMSEA as shown in Table 5.103 (.0513 - .0869) corroborated the finding of reasonable model fit because the lower bound value was only marginally larger than the suggested critical good fit cut-off point of .05<sup>353</sup> (Kenny, 2015), and the upper bound value only marginally higher than the suggested good fit critical cut-off of .08 (Kenny, 2015).

The Root mean square residual (RMR) is the third absolute fit statistic that was investigated in evaluating the fit of the comprehensive LISREL model. The RMR is the coefficient that results from taking the square root of the mean residuals, which are the amounts by which the sample variances and covariances differ from the corresponding estimated variances and covariances, estimated on the assumption that the fitted model is correct. In this regard, the RMR value delivered for the graduate leader performance comprehensive LISREL model delivered a value of .0171. However, the range of RMR is calculated by using the indicator variables (or item parcels); making the index sensitive to the unit of measurement and thus difficult to determine or interpret what a RMR score actually means (Kline, 2005). The Standardised RMR (SRMR) fortunately offers a way around this problem in that this index is a standardised translation of the RMR – thus SRMR ranges from zero to 1, and is zero when a model demonstrates perfect fit (Hooper et al., 2008). The SRMR for the fitted graduate leader performance LISREL model delivered a value of .041, which suggested close fit (< .05) (Byrne, 1998; Diamantopoulos & Siguaw, 2000) in contrast to the results delivered by the RMSEA statistic.

The fourth absolute fit index that was investigated in evaluating the comprehensive LISREL model fit is the Goodness of fit index (GFI), which indicates how closely a fitted model comes to replicating the observed covariance matrix (Diamantopoulos & Siguaw, 2000) by calculating the proportion of variance that is accounted for by the estimated population covariance (Tabachnik & Fidell, 2007) – i.e. the percentage of observed covariance explained by the covariances implied by the fitted model. This statistic is routinely reported along with the Adjusted goodness of fit index (AGFI), which in turn, is only a variant of the GFI that is simply adjusted for degrees of freedom. Both GFI and AGFI values can range between zero and 1, where contrary to the logic of the absolute fit indices discussed thus far, zero represents *no fit* and 1 represents *perfect fit* (Hu & Bentler, 1999). For both the GFI and AGFI, contemporary guidelines recommend a cut-off value of .90 in order to support a finding of good fit (Hooper et al., 2008). Maybe more importantly, both the GFI and AGFI are reportedly sensitive to sample size (the GFI has a downward bias when there are a large number of degrees of freedom in comparison to sample size (Sharma, Mukherjee, Kumar, & Dillon, 2005) and also an upward bias with large samples (Bollen, 1990; Miles & Shevlin, 1998) in general, while the AGFI tends to increase with sample size (Hooper et al., 2008)) and both indices favour more parsimonious models (MacCallum & Hong, 1997; Tabachnik & Fidell, 2007). Given the sensitivity of these two indices, they are not typically regarded as definitive, stand-alone, indicators of model fit (Hooper et al., 2008). Nonetheless, the GFI and AGFI values for the graduate leader performance comprehensive LISREL model delivered the values of .850 and .781 respectively, which was suggestive of at least reasonable model fit.

Byrne (1998) and Theron and Spangenberg (2005) describe the expected cross-validation index (ECVI) as a metric focussing on overall error or the difference between the reproduced sample covariance matrix ( $S'$ ) derived from fitting the model on the sample at hand, and the expected covariance matrix that would be obtained in an independent sample of the same size from the same population. As the purpose of this metric is therefore on reporting the difference between

---

<sup>353</sup> Therefore, even on a 10% significance level the close fit null hypothesis would still have been rejected ( $p < .10$ ), albeit only just.

$S^2$  and  $\Sigma$ , Diamantopoulos and Siguaw (2000) suggest that it can serve as a useful indicator of a model's overall fit as well. To assess the ECVI of the comprehensive LISREL model, its calculated ECVI value was compared to that of the saturated<sup>354</sup> as well as the independence<sup>355</sup> models. In this regard, it was found that the comprehensive graduate leader performance LISREL model's ECVI (2.27) was smaller than both the ECVI for the saturated model (2.591) and the ECVI for the independence model (58.505). Thus, it appeared more likely for a model closely representing the fitted model to be replicated in a cross-validation sample<sup>356</sup> than it was for a model to be replicated that closely represented the saturated or independence models. Although one would expect the fitted model to be at least a better fit than the independence model, this finding nonetheless commented favourably on model fit as it suggested that the fitted model seemed to have a better chance of being replicated in a cross-validation sample than the (more complex) saturated or the (less complex) independence models did.

The final (perhaps less conventional) absolute measure of fit that was investigated is the Critical N (CN) value as per the LISREL output on Table 5.103. Hoelter's Critical N is a goodness of fit measure that was developed to test the adequacy of sample size when evaluating model fit. The CN statistic suggests the size of the sample that would have obtained the minimum fit function chi-square statistic at the 0.5 significance level (Theron & Spangenberg, 2005). The generally accepted threshold for Hoelter's critical N is 200 – i.e. the sample size is sufficient if Hoelter's N is equal or greater than 200. The estimated CN value (108.068) for the graduate leader performance comprehensive LISREL model fell below the recommended value of 200 (Diamantopoulos, & Siguaw, 2000; Theron & Spangenberg, 2005), suggesting that the sample size of the fitted model was perhaps not adequate (in terms of statistical power) for evaluating the comprehensive LISREL model fit.

## 5.8.2 INCREMENTAL FIT INDICES

Incremental fit indices do not interpret the chi-square statistic in its raw form (Hooper et al., 2008) but rather compare the chi-square value to a baseline independence model instead. Therefore, these indices provide an indication of the *improvement* in the overall fit of the hypothesised model compared to the independence model and for this reason a critical cut-off of .90 (Theron & Spangenberg, 2005) or even .95 (Kumar, 2015) needs to be achieved in order to suggest good model fit – i.e. all of these indices range from zero to 1 where a value close to 1 indicates good fit. As part of its CFA output, LISREL calculates a number of incremental fit indices including the Comparative fit index (CFI), the Normed fit index (NFI), the Non-normed fit index (NNFI), the Incremental fit index (IFI) and the Relative fit index (RFI), all of which were used to evaluate the fit of the graduate leader performance comprehensive LISREL model. All these indices function on the same premise (although some adjust for degrees of freedom, etc.), namely that they compare the covariance matrix predicted by the fitted model to the observed covariance matrix, and the independence model with the observed covariance matrix, in order to gauge the percentage of lack of fit which is accounted for by moving from the independent model to the fitted model (Westland, 2015). As can be seen from Table 5.103, all of these indices delivered a value indicative of good (or close) model fit (CFI = .990; NFI = .975; NNFI = .987; IFI = .990; RFI = .967). In practical terms, this suggested that the fitted model could reproduce more than 96.7% of the covariation in the data, which was a favourable finding in support of close fit.

---

<sup>354</sup> In the saturated model, no constraints are placed on the population moments. The saturated model is the most general model possible.

<sup>355</sup> In the independence model, the observed variables are assumed to be uncorrelated with each other and the means of all observed variables are fixed at 0.

<sup>356</sup> According to Kelloway (1998), smaller ECVI values indicate a more parsimonious fit.

### 5.8.3 PARSIMONY FIT INDICES

Parsimony fit indices such as the Parsimony goodness of fit index (PGFI) and the parsimonious normed fit index (PNFI) are incremental fit indices similar to those mentioned above, but they *correct* for model parsimony and as such, are therefore more appropriately defined as parsimony-corrected incremental fit indices. These indices penalise models that are less parsimonious so that simpler theoretical models are favoured above ones that are more complex. Thus, parsimony fit indices take into account the degrees of freedom available for testing the fitted model, given the available data, and estimates more parameters until *the best parsimonious or perfect fit* is achieved, consequently providing an incremental fit index between the fitted and the *perfect*<sup>357</sup> model. Put differently, indices like the PGFI or PNFI provide the researcher with information about how any theoretical model could be improved by making it less complex (while still adequately explaining the observed data) and for this reason, there will always be some difficulty in establishing a universal cut-off threshold (indicative of good model fit) for meaningfully interpreting them (Hooper et al., 2008). Furthermore, because these indices penalise for model complexity, the values for these indices are usually considerably lower than that of other incremental goodness of fit indices (Hooper et al., 2008). As can be seen from Table 5.103, the PGFI and PNFI for the fitted comprehensive LISREL model delivered the values of .582 and .746 respectively, which commented averagely on model fit (in terms of model parsimony). The researcher, however, did not read too much into this finding, as it was the goal of this study to prove or disprove an *a priori* specified theoretical structural model and it was theoretically more correct (and ethical) to evaluate this model's fit independently of considerations about model/theory parsimony.<sup>358</sup>

Furthermore, information criteria (sometimes also referred to as *model selection criteria*) like the Akaike Information Criterion (AIC) and the Consistent Akaike Information Criterion (CAIC) represent a second category of metrics that can be classified under the banner of parsimony fit indices. As was the case with the ECVI, by default LISREL calculates values for the default model (i.e. the fitted model), as well as for a saturated and an independent model for each statistic respectively. The AIC and CAIC are indices that are used for the purposes of model comparison, with the smallest values being indicative of the best fitting model (Forrest & Shevlin, 2003).<sup>359</sup> However, these statistics are used differently within the context of model comparisons than was the case with the ECVI. While ECVI provides a test of whether a fitted model can be reproduced in a cross-validation sample, AIC is equivalent to the chi-square statistic (adjusted for model complexity) and is "generally used when comparing non-nested and non-hierarchical models estimated with the same data" (Hooper et al., 2008, p. 56) to indicate to the researcher which of the models are the most parsimonious. CAIC is used in a similar manner and is equivalent to AIC but simply adjusts for sample size as well. An investigation of the values of the AIC (AIC = 299.705) presented in Table 5.103 suggested that the fitted comprehensive LISREL model provided a more parsimonious fit than both the independence (7722.711) and the saturated models (342.999). The values delivered for the Consistent AIC (CAIC) (509.784) likewise suggested that the fitted comprehensive LISREL model provided a more parsimonious fit than both the independence (7792.737) and saturated models (1007.250). Thus, the only conclusion the researcher could really come to here was that the default model (under investigation) fitted better than the independence and saturated models, as the non-normed AIC and CAIC provide no way of interpreting the true quality of fit.

<sup>357</sup> Perfect in this context, refers to the least complicated model that would still fit the data at hand well.

<sup>358</sup> If an alternative (less complex) model or theory also fitted the data, the researcher could always explore this at a later stage.

<sup>359</sup> Note that AIC and CAIC are not normed to a 0-1 scale and it is difficult to suggest a critical cut-off for these metrics "other than that the model that produces the lowest value is the most superior" (Hooper et al., 2008, p. 56).

#### 5.8.4 SUMMARY OF MODEL FIT

The preceding discussion covered the results of a wide array of fit indices and metrics that were often conflicting in their findings, yet added depth and complexity to the evaluation of the fit of the graduate leader performance comprehensive LISREL model. Despite the fact that the null hypotheses of exact fit (as per the Satorra-Bentler chi-square statistic) and close fit (as per RMSEA) had to be rejected, a number of other indices provided more positive evidence in support of operational hypothesis 6 of this study. Most notably, all of the incremental fit indices as well as SRMR contradicted the RMSEA finding. Moreover, the ECVI, AIC and CAIC delivered as positive a result as was possible given the circumstances (i.e. the default model was compared to the independence and saturated models, and was not used for comparing nested models or for cross-sample validation models). The same can be said for the performance of the primary parsimony goodness of fit indices (i.e. the PGFI and PNFI). Conversely, the less than satisfactory performance of the sample sensitive GFI and AGFI estimations also had to be interpreted in conjunction with the ECVI results, which suggested that the study's sample size was perhaps too small to adequately evaluate the fit of the comprehensive LISREL model.

As there was clearly no simple way of synthesising these results, the researcher turned to the advice of Hu and Bentler (1999) in settling on a decision-making rule for the interpretation of model fit in this study. In this regard, they advocate for a 'two-index presentation strategy' in making conclusions regarding model fit in which (specific combinations) of an absolute and incremental index of model fit are used as the substantiating indicators of model fit. An explanation of their two-index presentation strategy as it was applied to the current study is depicted in Table 5.104 below.

Table 5.104

#### *Hu and Bentler's (1999) Two-index presentation strategy combination rules*

Combination rule	Cut-off values rule	PGLCQ incremental fit	PGLCQ absolute fit	Outcome of model fit
NNFI and SRMR	NNF of .096 or higher and an SRMR of .09 or lower	NNF = .987	SRMR = .04	Good (close) fit
RMSEA and SRMR	RMSEA of .06 or lower and a SRMR of .09 or lower	RMSEA = .069	SRMR = .04	Good (close) fit <sup>360</sup>
CFI and SRMR	CFI of .95 or higher and a SRMR of .09 or lower	CFI = .990	SRMR = .04	Good (close) fit

As can be deduced from Table 5.104, the results delivered for the graduate leader performance comprehensive LISREL model met all of the conditions for all three of Hu and Bentler's (1999) two-index presentation strategy combination rules. This suggested that despite the fact that the close fit null hypothesis under RMSEA had to be rejected, that the NNFI, CFI and SRMR indices provided enough evidence to overrule this finding to that of close fit.

### 5.9 EXAMINING THE COMPREHENSIVE GRADUATE LEADER PERFORMANCE LISREL MODEL RESIDUALS

The large standardised variance-covariance residuals (>2.58 or < 2.58) for the comprehensive graduate leader performance LISREL model are summarised in Table 5.105 below. The fitted model did not over- or underestimate any of the 171<sup>361</sup> variances and covariances observed in the covariance matrix (0%). The fitted comprehensive LISREL model therefore succeeded in

<sup>360</sup> It is acknowledged that the RMSEA value was found to be statistically **insignificant** ( $p < .05$ ) and that the RMSEA value of .069 could be interpreted as fractionally off the suggested 0.06 cut-off.

<sup>361</sup>  $(18 \times 19)/2 = 342/2 = 171$

accurately reproducing all of the unique variances and covariances in the observed sample covariance matrix. The non-existence of large residuals commented extremely favourably on the fit of the comprehensive graduate leader performance LISREL model.

Table 5.105

*Summary statistics for the standardised residuals of the comprehensive LISREL model*

Description	Value
Smallest Standardised Residual	
Residual for Comp_D2 and Comp_E1	-1.638
Median Standardised Residual	0.029
Residual for Comp_F2 and Comp_I2	1.886
Largest Standardised Residual	

The distribution of the standardised residuals is shown in Figure 5.20. In order to support the finding of exact fit, the spread of the residuals should have been dispersed in a perfectly symmetrical shape around zero. Figure 5.20 indicates that although the median standardised residual was very close to zero (.029), the distribution was slightly negatively skewed (i.e. the positive residuals tended to dominate slightly), which suggested that the model parameters were more inclined to underestimate the observed variance and covariance terms rather than to overestimate them. This finding seems to contradict the conclusion that was derived earlier from the ECVI, AIC and CAIC fit statistics. Nevertheless, the stem-and-leaf plot, in conjunction with the absence of large, statistically significant ( $p < .01$ ) standardised residuals provided adequate evidence of good (or close) fit.

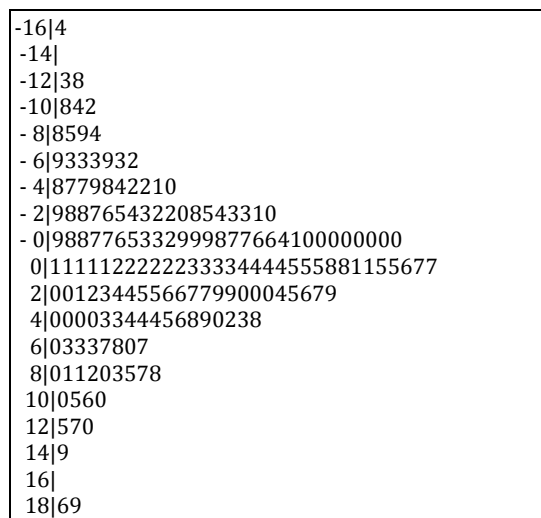

*Figure 5.20.* Stem-and-leaf plot of the standardised residuals for the comprehensive graduate leader performance LISREL model

The Q-plot for the comprehensive graduate leader performance LISREL model is depicted in Figure 5.21. The Q-plot shows that the PGLCQ data deviated somewhat from the 45-degree reference line. In this regard, it was evident that the data points rotated away from the 45-degree reference line at the upper end in a negative direction, and in the lower end in a positive direction. As the ideal would have been for the Q-plot to perfectly superimpose itself on the 45-degree reference line, this finding corroborated the conclusion that normality in the distribution of standardised residuals was not achieved. However, the model residual results still suggested that satisfactory (or close) fit was achieved.



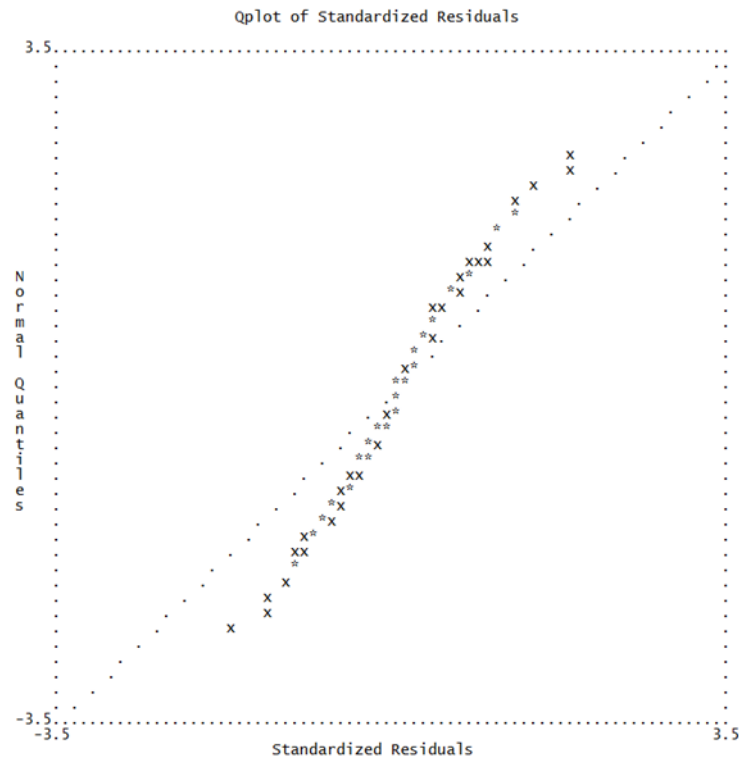

Figure 5.21. Q-plot for the comprehensive graduate leader performance LISREL model

As the fit statistics and the variance-covariance residuals suggested a good to reasonably fitting comprehensive LISREL model and the PGLCQ measurement model demonstrated close fit, it was reasonable to assume that the graduate leader performance structural model achieved good to reasonable fit in the parameter. Following this train of thought, the researcher consequently concluded that the conditions set for operational hypothesis 6 were sufficiently satisfied to regard the hypothesis as corroborated. What remained, therefore, was to investigate the tenability of operational hypotheses 7 and 8.

## 5.10 ASSESSING THE STRUCTURAL RELATIONSHIPS IN THE COMPREHENSIVE GRADUATE LEADER PERFORMANCE LISREL MODEL

The primary objective of the evaluation of the structural model parameter estimates was to determine if each of the hypothesised path-specific relationships, as theoretically motivated in Chapter 2 and formulated as path-specific hypotheses under operational hypothesis 7 in Chapter 3, were supported by the data. When these path-specific hypotheses were evaluated, four considerations (Diamantopoulos & Siguaw, 2000) were paramount:

- a) The signs (positive/negative) of the parameters representing the paths between the latent variables were inspected to determine whether the direction of the relationships was as theorised and predicted;
- b) The statistical significance ( $p < .05$ ) of the estimated path coefficients was inspected to determine whether the estimates could be generalised to the parameter;
- c) The magnitude of the (completely standardised) estimated parameters was inspected to determine the strengths of the hypothesised relationships; and
- d) The squared multiple correlations ( $R^2$ ) of the structural equations were inspected to establish the proportion of variance in each endogenous variable that was accounted for by the latent variables that were hypothesised to impact upon it.

Operational hypothesis 7 was tested by testing the following null hypotheses:

- Path-specific substantive hypothesis 1: In the proposed graduate leadership@work competency domain structural model<sup>362</sup> it is hypothesised that a high level of *personal leader proficiency* (Comp\_A;  $\xi_1$ ) will improve leadership effectiveness in *entrenching a high- performance culture in the unit* (Comp\_D;  $\eta_1$ );

$$H_{077}: \gamma_{11} = 0$$

$$H_{a77}: \gamma_{11} > 0$$

- Path-specific substantive hypothesis 2: In the proposed graduate leadership@work competency domain structural model it is hypothesised that a high level of *personal leader proficiency* (Comp\_A;  $\xi_1$ ) will improve leadership effectiveness in *creating an exciting and aspirational vision* (Comp\_C;  $\eta_2$ );

$$H_{078}: \gamma_{21} = 0$$

$$H_{a78}: \gamma_{21} > 0$$

- Path-specific substantive hypothesis 3: In the proposed graduate leadership@work competency domain structural model it is hypothesised that a high level of *personal leader proficiency* (Comp\_A;  $\xi_1$ ) will improve leadership effectiveness in *analysing and understanding the external and internal work unit environment* (Comp\_B;  $\eta_3$ );

$$H_{079}: \gamma_{31} = 0$$

$$H_{a79}: \gamma_{31} > 0$$

- Path-specific substantive hypothesis 4: In the proposed graduate leadership@work competency domain structural model it is hypothesised that a high level of *personal leader proficiency* (Comp\_A;  $\xi_1$ ) will improve leadership effectiveness in the *development of unit competitiveness* (Comp\_E;  $\eta_4$ );

$$H_{080}: \gamma_{41} = 0$$

$$H_{a80}: \gamma_{41} > 0$$

- Path-specific substantive hypothesis 5: In the proposed graduate leadership@work competency domain structural model it is hypothesised that a high level of *personal leader proficiency* (Comp\_A;  $\xi_1$ ) will improve leadership effectiveness in the *management of the unit's internal environment* (Comp\_I;  $\eta_8$ );

$$H_{081}: \gamma_{81} = 0$$

$$H_{a81}: \gamma_{81} > 0$$

- Path-specific substantive hypothesis 6: In the proposed graduate leadership@work competency domain structural model it is hypothesised that high proficiency in the *entrenchment of a high-performance culture* (Comp\_D;  $\eta_1$ ) will improve leadership effectiveness in *strengthening and enabling followers* (Comp\_H;  $\eta_7$ );

$$H_{082}: \beta_{71} = 0$$

$$H_{a82}: \beta_{71} > 0$$

---

<sup>362</sup> The phrase *in the proposed graduate leadership@work competency domain structural model* is used on purpose to reflect the fact that  $\gamma_{ij}$  and  $\beta_{ij}$  represent partial regression coefficients that reflect the average change in  $\eta_i$  associated with one unit change in  $\xi_j$  or  $\eta_j$  when controlling for the other latent variables in the structural equation of  $\eta_i$ .

- Path-specific substantive hypothesis 7: In the proposed graduate leadership@work competency domain structural model it is hypothesised that high proficiency in the *entrenchment of a high-performance culture* (Comp\_D;  $\eta_1$ ) will improve leadership effectiveness in *uniting and connecting followers* (Comp\_G;  $\eta_6$ );

$$H_{083}: \beta_{61} = 0$$

$$H_{a83}: \beta_{61} > 0$$

- Path-specific substantive hypothesis 8: In the proposed graduate leadership@work competency domain structural model it is hypothesised that high proficiency in the *entrenchment of a high-performance culture* (Comp\_D;  $\eta_1$ ) will improve leadership effectiveness in *involving others and eliciting participation* (Comp\_F;  $\eta_5$ );

$$H_{084}: \beta_{51} = 0$$

$$H_{a84}: \beta_{51} > 0$$

- Path-specific substantive hypothesis 9: In the proposed graduate leadership@work competency domain structural model it is hypothesised that high proficiency in *involving others and eliciting participation* (Comp\_F;  $\eta_5$ ) will improve leadership effectiveness in the *development of unit competitiveness* (Comp\_E;  $\eta_4$ );

$$H_{085}: \beta_{45} = 0$$

$$H_{a85}: \beta_{45} > 0$$

- Path-specific substantive hypothesis 10: In the proposed graduate leadership@work competency domain structural model it is hypothesised that high proficiency in *analysing and understanding the environment* (Comp\_B;  $\eta_3$ ) will improve leadership effectiveness in *developing the unit's competitiveness* (Comp\_E;  $\eta_4$ );

$$H_{086}: \beta_{43} = 0$$

$$H_{a86}: \beta_{43} > 0$$

- Path-specific substantive hypothesis 11: In the proposed graduate leadership@work competency domain structural model it is hypothesised that high proficiency in *developing unit competitiveness* (Comp\_E;  $\eta_4$ ) will improve leadership effectiveness in *managing the unit's internal environment* (Comp\_I;  $\eta_8$ );

$$H_{087}: \beta_{84} = 0$$

$$H_{a87}: \beta_{84} > 0$$

- Path-specific substantive hypothesis 12: In the proposed graduate leadership@work competency domain structural model it is hypothesised that high proficiency in *strengthening and enabling followers* (Comp\_H;  $\eta_7$ ) will improve leadership effectiveness in *managing the unit's internal environment* (Comp\_I;  $\eta_8$ );

$$H_{088}: \beta_{87} = 0$$

$$H_{a88}: \beta_{87} > 0$$

- Path-specific substantive hypothesis 13: In the proposed graduate leadership@work competency domain structural model it is hypothesised that high proficiency in *uniting and connecting followers* (Comp\_G;  $\eta_6$ ) will improve leadership effectiveness in *managing the unit's internal environment* (Comp\_I;  $\eta_8$ );

$$H_{089}: \beta_{86} = 0$$

$$H_{a89}: \beta_{86} > 0$$

- Path-specific substantive hypothesis 14: In the proposed graduate leadership@work competency domain structural model it is hypothesised that high proficiency in *involving others and eliciting participation* (Comp\_F;  $\eta_5$ ) will improve leadership effectiveness in *managing the unit's internal environment* (Comp\_I;  $\eta_8$ );

$$H_{090}: \beta_{85} = 0$$

$$H_{a90}: \beta_{85} > 0$$

- Path-specific substantive hypothesis 15: In the proposed graduate leadership@work competency domain structural model it is hypothesised that high proficiency in the *management of the unit's internal environment* (Comp\_I;  $\eta_8$ ) will improve leadership effectiveness in *analysing and understanding the external and internal work unit environment* (Comp\_B;  $\eta_3$ );

$$H_{091}: \beta_{38} = 0$$

$$H_{a91}: \beta_{38} > 0$$

- Path-specific substantive hypothesis 16: In the proposed graduate leadership@work competency domain structural model it is hypothesised that high proficiency on *analysing and understanding the external and internal work unit environment* (Comp\_B;  $\eta_3$ ) will improve leadership effectiveness in *the creation of an exciting and aspirational vision* (Comp\_C;  $\eta_2$ );

$$H_{092}: \beta_{23} = 0$$

$$H_{a92}: \beta_{23} > 0$$

- Path-specific substantive hypothesis 17: In the proposed graduate leadership@work competency domain structural model it is hypothesised that high proficiency in the *creation of an exciting and aspirational vision* (Comp\_C;  $\eta_2$ ) will improve leadership effectiveness in *entrenching a high-performance culture in the unit* (Comp\_D;  $\eta_1$ );

$$H_{093}: \beta_{12} = 0$$

$$H_{a93}: \beta_{12} > 0$$

- Path-specific substantive hypothesis 18: In the proposed graduate leadership@work competency domain model it is hypothesised that high proficiency in the *creation of an exciting and aspirational vision* (Comp\_C;  $\eta_2$ ) will improve leadership effectiveness in *developing the unit's competitiveness* (Comp\_E;  $\eta_4$ );

$$H_{094}: \beta_{42} = 0$$

$$H_{a94}: \beta_{42} > 0$$

The z-values corresponding to the unstandardised parameter estimates for the beta (**B**) and gamma (**Γ**) matrices were used to evaluate the causal linkages between the exogenous and endogenous latent variables (**Γ**), and between the endogenous latent variables (**B**) of the fitted structural model. The unstandardised beta matrix, as presented in Table 5.106, describes the slope of the regression of endogenous latent variables on the endogenous latent variables that were hypothesised to affect them in the graduate leader performance structural model. These parameter estimates were interpreted as statistically significant ( $p < .05$ ) if their corresponding z-values were found to be equal or higher than 1.6449.

As can be seen from Table 5.106 below, the unstandardised beta matrix indicated that the path coefficients associated with eight, out of the thirteen original hypothesised paths, were statistically significant ( $p < .05$ ). Furthermore, the signs (positive) of all of the statistically significant  $\beta$  parameter estimates were found to be consistent with the nature of the hypothesised relationships between the latent variables.  $H_{082}$ ,  $H_{083}$ ,  $H_{084}$ ,  $H_{087}$ ,  $H_{089}$ ,  $H_{092}$ ,  $H_{093}$  and  $H_{094}$ , were therefore rejected.  $H_{085}$ ,  $H_{086}$ ,  $H_{088}$ ,  $H_{090}$  and  $H_{091}$  in turn, could not be rejected.

Table 5.106

*Unstandardised beta matrix for the graduate leader performance structural model*

	COMP_D	COMP_C	COMP_B	COMP_E	COMP_F	COMP_G	COMP_H	COMP_I
COMP_D	--	0.658* (0.103) 6.390	--	--	--	--	--	--
COMP_C	--	--	0.488* (0.103) 4.749	--	--	--	--	--
COMP_B	--	--	--	--	--	--	--	0.243 (0.151) 1.609
COMP_E	--	0.395* (0.182) 2.168	0.174 (0.163) 1.063	--	0.101 (0.127) 0.793	--	--	--
COMP_F	0.864* (0.078) 11.090	--	--	--	--	--	--	--
COMP_G	0.849* (0.084) 10.138	--	--	--	--	--	--	--
COMP_H	0.916* (0.064) 14.419	--	--	--	--	--	--	--
COMP_I	--	--	--	0.406* (0.087) 4.662	-0.037 (0.118) -0.315	0.271* (0.127) 2.129	0.108 (0.150) 0.719	--

\*( $p < .05$ )

Note: Comp\_B1 and Comp\_B2 refer to the two item parcels operationalising the *analyses and understands the external and internal work unit environment* variable (COMP\_B); Comp\_C1 and Comp\_C2 refer to the two item parcels operationalising the *creates an exciting and aspirational vision for the unit* latent variable (COMP\_C); Comp\_D1 and Comp\_D2 refer to the two item parcels operationalising the *entrenches a high-performance culture in the unit* latent variable (COMP\_D); Comp\_E1 and Comp\_E2 refer to the two item parcels operationalising the *develops unit competitiveness* latent variable (COMP\_E); Comp\_F1 and Comp\_F2 refer to the two item parcels operationalising the *Involves others and elicits participation* latent variable (COMP\_F); Comp\_G1 and Comp\_G2 refer to the two item parcels operationalising the *unites and connects followers* latent variable (COMP\_G); Comp\_H1 and Comp\_H2 refer to the two item parcels operationalising the *strengthens and enables followers* latent variable (COMP\_H); and Comp\_I1 and Comp\_I2 refer to the two item parcels operationalising the *manages the internal work unit environment* latent variable (COMP\_I).

Therefore, support was garnered for the following eight path-specific hypotheses under operational hypothesis 7:

- Path-specific substantive hypothesis 6: High proficiency on the *entrenchment of a high-performance culture* ( $\eta_1$ ) will improve leadership effectiveness in *strengthening and enabling followers* ( $\eta_7$ );
- Path-specific substantive hypothesis 7: High proficiency on the *entrenchment of a high-performance culture* ( $\eta_1$ ) will improve leadership effectiveness in *uniting and connecting others* ( $\eta_6$ );
- Path-specific substantive hypothesis 8: High proficiency on the *entrenchment of a high-performance culture* ( $\eta_1$ ) will improve leadership effectiveness in *involving others and eliciting participation* ( $\eta_5$ );
- Path-specific substantive hypothesis 11: High proficiency on *developing unit competitiveness* ( $\eta_4$ ) will improve leadership effectiveness in *managing the unit's internal environment* ( $\eta_8$ );

- Path-specific substantive hypothesis 13: High proficiency on *uniting and connecting followers* ( $\eta_6$ ) will improve leadership effectiveness in *managing the unit's internal environment* ( $\eta_8$ );
- Path-specific substantive hypothesis 16: High proficiency on *analysing and understanding the external and internal work unit environment* ( $\eta_3$ ) will improve leadership effectiveness in the *creation of an exciting and aspirational vision* ( $\eta_2$ );
- Path-specific substantive hypothesis 17: High proficiency on the *creation of an exciting and aspirational vision* ( $\eta_2$ ) will improve leadership effectiveness in *entrenching a high-performance culture in the unit* ( $\eta_1$ ); and
- Path-specific substantive hypothesis 18: High proficiency on the *creation of an exciting and aspirational vision* ( $\eta_2$ ) will improve leadership effectiveness in *developing the unit's competitiveness* ( $\eta_4$ ).

In each of the cases listed above, the finding meant that  $\eta_i$  significantly explained variance in  $\eta_j$  that was not explained by any other  $\eta_k$  or  $\xi_k$  linked to it in the graduate leader performance structural model. In contrast, however, it was also apparent from the output that the path coefficients associated with five of the thirteen originally hypothesised paths were not statistically significant ( $p > .05$ ). Therefore, the following five of the original thirteen path-specific hypothesis under operational hypothesis 7 were not corroborated:

- Path-specific substantive hypothesis 9: High proficiency on *involving others and eliciting participation* ( $\eta_5$ ) will improve leadership effectiveness in the *development of unit competitiveness* ( $\eta_4$ );
- Path-specific substantive hypothesis 10: High proficiency on *analysing and understanding the external and internal work unit environment* ( $\eta_3$ ) will improve leadership effectiveness in *developing the unit's competitiveness* ( $\eta_4$ );
- Path-specific substantive hypothesis 12: High proficiency on *strengthening and enabling followers* ( $\eta_7$ ) will improve leadership effectiveness in *managing the unit's internal environment* ( $\eta_8$ );
- Path-specific substantive hypothesis 14: High proficiency on *involving others and eliciting participation* ( $\eta_5$ ) will improve leadership effectiveness in *managing the unit's internal environment* ( $\eta_8$ ); and
- Path-specific substantive hypothesis 15: High proficiency on the *management of the unit's internal environment* ( $\eta_8$ ) will improve leadership effectiveness in *analysing and understanding the external and internal work unit environment* ( $\eta_3$ ).

Conversely, this finding meant that in each of the cases listed above,  $\eta_i$  did not significantly explain variance in  $\eta_j$  when statistically controlling for the other variables ( $\eta_k$  or  $\xi_k$ ) that are linked to  $\eta_j$  in the graduate leader performance structural model.

The unstandardised gamma matrix (see Table 5.107), on the other hand, describes the slope of the regression of the endogenous latent variables on specific exogenous latent variables that were hypothesised to affect them in the graduate leader performance structural model.

Table 5.107

*Unstandardised gamma matrix for the graduate leader performance structural model*

	COMP_A
COMP_D	0.269* (0.099)
	2.716
COMP_C	0.402* (0.097)
	4.124

Table 5.107

*Unstandardised gamma matrix for the graduate leader performance structural model (continued)*

	COMP_A
COMP_B	0.551* (0.154)
COMP_E	3.576 0.137 (0.118)
COMP_F	1.162 --
COMP_G	--
COMP_H	--
COMP_I	0.231* (0.095)
	2.433

\*(p &lt; .05)

Note: Comp\_A1 and Comp\_A2 refer to the two item parcels operationalising the *displays personal leader proficiency* latent variable (COMP\_A); Comp\_B1 and Comp\_B2 refer to the two item parcels operationalising the *analyses and understands the external and internal work unit environment* variable (COMP\_B); Comp\_C1 and Comp\_C2 refer to the two item parcels operationalising the *creates an exciting and aspirational vision for the unit* latent variable (COMP\_C); Comp\_D1 and Comp\_D2 refer to the two item parcels operationalising the *entrenches a high-performance culture in the unit* latent variable (COMP\_D); Comp\_E1 and Comp\_E2 refer to the two item parcels operationalising the *develops unit competitiveness* latent variable (COMP\_E); Comp\_F1 and Comp\_F2 refer to the two item parcels operationalising the *Involves others and elicits participation* latent variable (COMP\_F); Comp\_G1 and Comp\_G2 refer to the two item parcels operationalising the *unites and connects followers* latent variable (COMP\_G); Comp\_H1 and Comp\_H2 refers to the two item parcels operationalising the *strengthens and enables followers* latent variable (COMP\_H); and Comp\_I1 and Comp\_I2 refer to the two item parcels operationalising the *manages the internal work unit environment* latent variable (COMP\_I).

As can be seen from Table 5.107 above, there was only one exogenous latent variable in this study (Comp\_A). More importantly, the unstandardised gamma matrix indicated that the path coefficients associated with four out of the five original hypothesised paths between Comp\_A and its designated endogenous variables, were statistically significant ( $p < .05$ ) with z values larger than 1.6440. In addition, the signs (positive) of all of the  $\gamma$  parameter estimates were found to be consistent with the nature of the hypothesised relationships between the latent variables.  $H_{077}$ ,  $H_{078}$ ,  $H_{079}$ , and  $H_{081}$  were therefore rejected.  $H_{080}$ , in turn, could not be rejected.

Therefore, it was tenable to corroborate and generalise the following four path-specific hypotheses to the population:

- Path-specific substantive hypothesis 1: A high level of *personal leader proficiency* ( $\xi_1$ ) will improve leadership effectiveness in *entrenching a high-performance culture in the unit* ( $\eta_1$ );
- Path-specific substantive hypothesis 2: A high level of *personal leader proficiency* ( $\xi_1$ ) will improve leadership effectiveness in *creating an exciting and aspirational vision* ( $\eta_2$ );
- Path-specific substantive hypothesis 3: A high level of *personal leader proficiency* ( $\xi_1$ ) will improve leadership effectiveness in *analysing and understanding the external and internal work unit environment* ( $\eta_3$ ); and
- Path-specific substantive hypothesis 5: A high level of *personal proficiency* ( $\xi_1$ ) will improve leadership effectiveness in the *management of the unit's internal environment* ( $\eta_8$ ).

These findings indicated that in each of the cases listed above,  $\xi_i$  significantly explained variance in  $\eta_i$  that was not explained by any other  $\eta_k$  linked to it in the graduate leader performance structural model. On the other hand, the gamma output disparaged the tenability of just one path-specific hypothesis under the gamma matrix, which consequently was not corroborated:

- Path-specific substantive hypothesis 4: a high level of *personal leader proficiency* ( $\xi_1$ ) will improve leadership effectiveness in the *development of unit competitiveness* ( $\eta_4$ ).

Practically, this meant that the data collected via the PGLCQ did not support the notion that the *displays personal leader proficiency* competency positively influences leadership effectiveness in the *develops unit competitiveness* competency (when statistically controlling for the other latent variables that are structurally linked to the development of unit competitiveness variable in the graduate leader performance structural model – i.e. *creates an exciting and aspirational vision for the unit, involves others and elicits participation, analyses and understands the unit's external and internal work unit environment, and manages the internal work unit environment*).

Having established the statistical significance of the regression slopes, it was furthermore necessary to inspect their magnitudes. In order to evaluate the strength of the statistically significant ( $p < .05$ ) direct effects of the regression slopes in the structural model, the researcher duly consulted the completely standardised beta (Table 5.108) and gamma (Table 5.109) matrices. These matrices express the average change in the focal endogenous latent variable, expressed in standard deviation units, associated with one standard deviation change in either the endogenous or exogenous variable linked to it (when controlling for the other effects linked to  $\eta_i$  in the structural model).

Table 5.108

*Completely standardised beta matrix for the graduate leader performance structural model*

	COMP_D	COMP_C	COMP_B	COMP_E	COMP_F	COMP_G	COMP_H	COMP_I
COMP_D	--	.658	--	--	--	--	--	--
COMP_C	--	--	.488	--	--	--	--	--
COMP_B	--	--	--	--	--	--	--	.243
COMP_E	--	.395	.174	--	.101	--	--	--
COMP_F	.864	--	--	--	--	--	--	--
COMP_G	.849	--	--	--	--	--	--	--
COMP_H	.916	--	--	--	--	--	--	--
COMP_I				.406	-.037	.271	.108	

Note: Comp\_B1 and Comp\_B2 refer to the two item parcels operationalising the *analyses and understands the external and internal work unit environment* variable (COMP\_B); Comp\_C1 and Comp\_C2 refer to the two item parcels operationalising the *creates an exciting and aspirational vision for the unit* latent variable (COMP\_C); Comp\_D1 and Comp\_D2 refer to the two item parcels operationalising the *entrenches a high-performance culture in the unit* latent variable (COMP\_D); Comp\_E1 and Comp\_E2 refer to the two item parcels operationalising the *develops unit competitiveness* latent variable (COMP\_E); Comp\_F1 and Comp\_F2 refer to the two item parcels operationalising the *Involves others and elicits participation* latent variable (COMP\_F); Comp\_G1 and Comp\_G2 refer to the two item parcels operationalising the *unites and connects followers* latent variable (COMP\_G); Comp\_H1 and Comp\_H2 refer to the two item parcels operationalising the *strengthens and enables followers* latent variable (COMP\_H); and Comp\_I1 and Comp\_I2 refer to the two item parcels operationalising the *manages the internal work unit environment* latent variable (COMP\_I).

Table 5.109

*Completely standardised gamma matrix for the graduate leader performance structural model*

	COMP_A
COMP_D	.269
COMP_C	.402
COMP_B	.551
COMP_E	.137
COMP_F	--
COMP_G	--
COMP_H	--
COMP_I	.231

Note: Comp\_A1 and Comp\_A2 refer to the two item parcels operationalising the *displays personal leader proficiency* latent variable (COMP\_A); Comp\_B1 and Comp\_B2 refer to the two item parcels operationalising the *analyses and understands the external and internal work unit environment* variable (COMP\_B); Comp\_C1 and Comp\_C2 refer to the two item parcels operationalising the *creates an exciting and aspirational vision for the unit* latent variable (COMP\_C); Comp\_D1 and Comp\_D2 refer to the two item parcels operationalising the *entrenches a high-performance culture in the unit* latent variable (COMP\_D); Comp\_E1 and Comp\_E2 refer to the two item parcels operationalising the *develops unit competitiveness* latent variable (COMP\_E); Comp\_F1 and Comp\_F2 refer to the two item parcels operationalising the *Involves others and elicits participation* latent variable (COMP\_F); Comp\_G1 and Comp\_G2 refer to the two item parcels operationalising the *unites and connects followers* latent variable (COMP\_G); Comp\_H1 and Comp\_H2 refer to the two item parcels operationalising the *strengthens and enables followers* latent variable (COMP\_H); and Comp\_I1 and Comp\_I2 refer to the two item parcels operationalising the *manages the internal work unit environment* latent variable (COMP\_I).



Table 5.108 and 5.109 suggest that the latent *entrenches a high-performance culture* latent competency (Comp\_D) had the most pronounced effects overall in terms of its designated paths to other variables in the graduate leader performance competency model. This was evident in the direct effect estimates delivered for the *entrenches a high-performance culture* latent competency variable (Comp\_D) on the other latent competency variables of *involves others and elicits participation* (.864) (Comp\_F), *unites and connects followers* (.849) (Comp\_G), and *strengthens and enables followers* (.916) (Comp\_H) competencies respectively. The second most pronounced direct effect was evident for the latent *creates an exciting and aspirational vision for the unit* competency (Comp\_C) variable in its effect on the *entrenches a high-performance culture in the unit* (.658) latent competency variable. The third most prominent effect was apparent in the relationship between the *displays personal leader proficiency* latent competency (Comp\_A) variable and the latent *analyses and understands the external and internal work unit environment* competency (.551) (Comp\_B). This was followed by the effects of the latent *displays personal leader proficiency* competency (Comp\_A) on the latent *creates an exciting and aspirational vision for the unit* competency (.402) (Comp\_C), the latent *analyses and understands the external and internal work unit environment* competency (Comp\_B) on the latent *creates an exciting and aspirational vision for the unit* competency (.488) (Comp\_C), and the latent *creates an exciting and aspirational vision for the unit* competency (Comp\_C) on the latent *develops unit competitiveness* competency (0.395) (Comp\_E). Finally, the effect of the latent *unites and connects followers* (Comp\_G) on the latent *manages the internal work unit environment* competency (.271) (Comp\_I), and the effect of the latent *displays personal leader proficiency* competency (Comp\_A) on the latent *develops unit competitiveness* competency (.269) (Comp\_E) and on the latent *manages the internal work unit environment* competency (.231) were found to be the least pronounced effects in the model respectively. Nevertheless, overall most paths were of satisfactory magnitude.

Table 5.110 shows the R<sup>2</sup> values for the structural equations that indicate the proportion of variance that the graduate leader performance structural model explained in each of its eight endogenous ( $\eta$ ) latent variables. In other words, the R<sup>2</sup> values calculated here provided an indication of the amount of variance in each latent endogenous variable that was accounted for by all of the latent variables that were structurally linked to it in the model.

Table 5.110

*R<sup>2</sup> values for the endogenous latent variables of the graduate leader performance structural model*

COMP_D	COMP_C	COMP_B	COMP_E
.785	.711	.606	.577
COMP_F	COMP_G	COMP_H	COMP_I
.747	.730	.841	.508

Note: Comp\_B1 and Comp\_B2 refer to the two item parcels operationalising the *analyses and understands the external and internal work unit environment* variable (COMP\_B); Comp\_C1 and Comp\_C2 refer to the two item parcels operationalising the *creates an exciting and aspirational vision for the unit* latent variable (COMP\_C); Comp\_D1 and Comp\_D2 refer to the two item parcels operationalising the *entrenches a high-performance culture in the unit* latent variable (COMP\_D); Comp\_E1 and Comp\_E2 refer to the two item parcels operationalising the *develops unit competitiveness* latent variable (COMP\_E); Comp\_F1 and Comp\_F2 refer to the two item parcels operationalising the *Involves others and elicits participation* latent variable (COMP\_F); Comp\_G1 and Comp\_G2 refer to the two item parcels operationalising the *unites and connects followers* latent variable (COMP\_G); Comp\_H1 and Comp\_H2 refer to the two item parcels operationalising the *strengthens and enables followers* latent variable (COMP\_H); and Comp\_I1 and Comp\_I2 refer to the two item parcels operationalising the *manages the internal work unit environment* latent variable (COMP\_I).

It can be surmised from Table 5.110 that the graduate leader performance structural model explained an impressive amount of variance in most of the focal endogenous variables that were included in it. For example, the results suggested that the structural model explained 84% of the variance in the latent *strengthens and enables followers* competency (Comp\_G), 79% of the variance in the latent *entrenches a high-performance culture in the unit* competency (Comp\_D), 75% of the variance in the latent *involves others and elicits participation* competency (Comp\_F), 73% in the latent *unites and connects followers* competency (Comp\_G), and 71% of the variance in the latent *develops an exciting and aspirational vision for the unit* competency (Comp\_C). The variance accounted for by the structural model in the latent *analyses and understands the external and internal work unit environment* competency (60%) (Comp\_B), and the latent *develops unit*

*competitiveness* competency (58%) (Comp\_E) also deserved a noteworthy mention, although the structural model provided a somewhat less satisfactory explanation of the variance in the latent *manages the internal work unit environment* (50%) competency (Comp\_I). Interestingly enough, it appeared as if the amount of variance explained in each latent graduate leader competency variable dropped as the number of hypothesised paths running into each variable increased (i.e. as the number of variables assumed to influence another variable increased, the model's ability to explain variance in that variable decreased). This suggested that the more complex (determined) competency variables in the structural model (in terms of paths running into them) like *develops unit competitiveness* and *manages the internal work unit environment*, for example, could have perhaps benefited from a more comprehensive theoretical review while they were being conceptualised and their position and interrelations demarcated within the graduate leader performance structural model. It is, however, also possible that these latent variables constitute portals through which the latent competency potential variables and latent situational variables operate (other than through the *displays personal leader proficiency* latent competency). Ultimately, however, given these findings (i.e. support for 12 out of the 18 path-specific hypotheses), the statistical significance and magnitude of the regression slopes, as well as the endogenous latent variable variance accounted for by the structural model, most of the conditions for operational hypothesis 7 were considered satisfied (i.e. operational hypothesis 7 was therefore only partially supported).

### 5.11 EVALUATION OF THE STRUCTURAL ERROR VARIANCES IN THE COMPREHENSIVE GRADUATE LEADER PERFORMANCE LISREL MODEL

Finally, the unstandardised and standardised structural error variance ( $\psi$ ) matrices were investigated in order to evaluate the statistical significance ( $p < .05$ ) of the structural error variances and the magnitude of the variance in  $\eta_i$  that was not explained (or was unacknowledged) by the fitted graduate leader performance structural model. The unstandardised and standardised  $\psi$  matrices are presented in Table 5.111 and 5.112 below.

The statistical significance of the unstandardised structural error variance estimates was tested by testing the following statistical hypotheses for the freed elements in the variance-covariance matrix  $\Psi$  related to operational hypothesis 8:

$$H_{0i}: \psi_{kk} = 0; i = 95, 96, \dots, 102; k = 1, 2, \dots, 8$$

$$H_{ai}: \psi_{kk} > 0; i = 95, 96, \dots, 102; k = 1, 2, \dots, 8$$

Table 5.111

#### *Unstandardised psi matrix for the graduate leader performance structural model*

COMP_D	COMP_C	COMP_B	COMP_E
0.215*	0.289*	0.394*	0.423*
(0.047)	(0.058)	(0.115)	(0.075)
4.601	4.981	3.442	5.635
COMP_F	COMP_G	COMP_H	COMP_I
0.253*	0.270*	0.159*	0.251*
(0.064)	(0.084)	(0.055)	(0.045)
3.980	3.198	2.869	5.600

\* $p < .05$

Note: Comp\_B1 and Comp\_B2 refer to the two item parcels operationalising the *analyses and understands the external and internal work unit environment* variable (COMP\_B); Comp\_C1 and Comp\_C2 refer to the two item parcels operationalising the *creates an exciting and aspirational vision for the unit* latent variable (COMP\_C); Comp\_D1 and Comp\_D2 refer to the two item parcels operationalising the *entrenches a high-performance culture in the unit* latent variable (COMP\_D); Comp\_E1 and Comp\_E2 refer to the two item parcels operationalising the *develops unit competitiveness* latent variable (COMP\_E); Comp\_F1 and Comp\_F2 refer to the two item parcels operationalising the *Involves others and elicits participation* latent variable (COMP\_F); Comp\_G1 and Comp\_G2 refer to the two item parcels operationalising the *unites and connects followers* latent variable (COMP\_G); Comp\_H1 and Comp\_H2 refers to the two item parcels operationalising the *strengthens and enables followers* latent variable (COMP\_H); and Comp\_I1 and Comp\_I2 refer to the two item parcels operationalising the *manages the internal work unit environment* latent variable (COMP\_I).

Table 5.112

*Completely standardised psi matrix for the graduate leader performance structural model*

COMP_D	COMP_C	COMP_B	COMP_E
.215	.289	.394	.423
COMP_F	COMP_G	COMP_H	COMP_I
.253	.270	.159	.251

Note: Comp\_B1 and Comp\_B2 refer to the two item parcels operationalising the *analyses and understands the external and internal work unit environment* variable (COMP\_B); Comp\_C1 and Comp\_C2 refer to the two item parcels operationalising the *creates an exciting and aspirational vision for the unit* latent variable (COMP\_C); Comp\_D1 and Comp\_D2 refer to the two item parcels operationalising the *entrenches a high-performance culture in the unit* latent variable (COMP\_D); Comp\_E1 and Comp\_E2 refer to the two item parcels operationalising the *develops unit competitiveness* latent variable (COMP\_E); Comp\_F1 and Comp\_F2 refer to the two item parcels operationalising the *Involves others and elicits participation* latent variable (COMP\_F); Comp\_G1 and Comp\_G2 refer to the two item parcels operationalising the *unites and connects followers* latent variable (COMP\_G); Comp\_H1 and Comp\_H2 refer to the two item parcels operationalising the *strengthens and enables followers* latent variable (COMP\_H); and Comp\_I1 and Comp\_I2 refer to the two item parcels operationalising the *manages the internal work unit environment* latent variable (COMP\_I).

From Table 5.111 it was evident that all eight of the structural error variance estimates delivered a statistically significant ( $p < .05$ ) finding.  $H_{0i}: \psi_{kk} = 0$ ;  $i = 95, 96, \dots, 102$ ;  $k = 1, 2, \dots, 8$  could therefore be rejected for all  $i = 95, 96, \dots, 102$ . This was consistent with expectations, as the researcher did not anticipate the graduate leader performance structural model to be perfect or 'complete'. However, the completely standardised output of  $\Psi$  (as were the  $R^2$  value shown in Table 5.110) was not in line with the researcher's expectations in that the values delivered in Table 5.112 were suggestive of the fact that the graduate leader performance structural model was not able to account for only relatively small error variances. In this regard, the structural error variances that were reported ranged from between 16% (Comp\_G; *unites and connects followers*) and 39% (Comp\_B; *analyses and understands the external and internal work unit environment*). Thus, in contrast to the conditions set under operational hypothesis 8, the endogenous variables in the graduate leader performance structural model appeared to explain much more variance in each other than was initially anticipated, and the hypothesis had to be rejected. The rejection of this hypothesis, however, did not comment unfavourably on the ability of the graduate leader performance structural model's ability to explain variance in its endogenous variables. In fact, the results obtained here actually exceeded the researcher's expectations in terms of the validity of the graduate leader performance structural model and its ability to account for a highly complex nomological network of causal and feedback effects between latent variables, latent situational variables, and latent competency potential variables, most of which were not even formally acknowledged in its structure.

## 5.12 MODIFICATION INDICES CALCULATED FOR THE COMPREHENSIVE GRADUATE LEADER PERFORMANCE LISREL MODEL

Although the fit statistics and the variance-covariance residuals suggested a good fitting comprehensive LISREL model, LISREL by default calculates modification indices as part of its output when fitting a model that could be used to improve model fit should given parameters be added to the model. In this regard, modification indices estimate the expected decrease in the chi-square statistic that would be realised when current fixed parameters are set free and the model is re-estimated accordingly. Modification index values exceeding 6.64 were interpreted as indicative of parameters that would statistically significantly improve the fit of a model when they are freed ( $p < .01$ ). However, both MacCallum (1995) and Diamantopoulos and Siguaaw (2000) caution against the use of post hoc modifications to models and assert that these should only be viewed as tentative *improvements* until cross-validated on an independent sample, and that such modifications should only be considered when they are theoretically and practically plausible. The current study fully endorses this position and regards the modification indices as providing the basis of data-driven recommendations for future research (see Chapter 6). Table 5.113 shows the modification indices that LISREL calculated for  $\mathbf{B}$  and Table 5.114 shows the modification indices for  $\mathbf{\Gamma}$ .

Table 5.113

*Modification indices for the beta matrix*

	COMP_D	COMP_C	COMP_B	COMP_E	COMP_F	COMP_G	COMP_H	COMP_I
COMP_D	--	--	1.122	0.031	0.422	0.854	1.588	0.689
COMP_C	0.090	--	--	0.023	2.531	0.025	0.567	0.082
COMP_B	0.538	0.005	--	0.048	5.043	0.082	0.120	--
COMP_E	0.174	--	--	--	--	0.042	0.730	--
COMP_F	--	--	18.995*	0.755	--	--	--	--
COMP_G	--	1.553	0.371	0.101	17.775*	--	--	--
COMP_H	--	0.537	1.304	3.929	0.117	0.061	--	--
COMP_I	0.145	0.346	--	--	--	--	--	--

\*p &lt; .01

Note: Comp\_B1 and Comp\_B2 refer to the two item parcels operationalising the *analyses and understands the external and internal work unit environment* variable (COMP\_B); Comp\_C1 and Comp\_C2 refer to the two item parcels operationalising the *creates an exciting and aspirational vision for the unit* latent variable (COMP\_C); Comp\_D1 and Comp\_D2 refer to the two item parcels operationalising the *entrenches a high-performance culture in the unit* latent variable (COMP\_D); Comp\_E1 and Comp\_E2 refer to the two item parcels operationalising the *develops unit competitiveness* latent variable (COMP\_E); Comp\_F1 and Comp\_F2 refer to the two item parcels operationalising the *Involves others and elicits participation* latent variable (COMP\_F); Comp\_G1 and Comp\_G2 refer to the two item parcels operationalising the *unites and connects followers* latent variable (COMP\_G); Comp\_H1 and Comp\_H2 refer to the two item parcels operationalising the *strengthens and enables followers* latent variable (COMP\_H); and Comp\_I1 and Comp\_I2 refer to the two item parcels operationalising the *manages the internal work unit environment* latent variable (COMP\_I).

Table 5.114

*Modification indices for the gamma matrix*

	COMP_A
COMP_D	--
COMP_C	--
COMP_B	--
COMP_E	--
COMP_F	0.000
COMP_G	1.254
COMP_H	5.443
COMP_I	--

Note: Comp\_B1 and Comp\_B2 refer to the two item parcels operationalising the *analyses and understands the external and internal work unit environment* variable (COMP\_B); Comp\_C1 and Comp\_C2 refer to the two item parcels operationalising the *creates an exciting and aspirational vision for the unit* latent variable (COMP\_C); Comp\_D1 and Comp\_D2 refer to the two item parcels operationalising the *entrenches a high-performance culture in the unit* latent variable (COMP\_D); Comp\_E1 and Comp\_E2 refer to the two item parcels operationalising the *develops unit competitiveness* latent variable (COMP\_E); Comp\_F1 and Comp\_F2 refer to the two item parcels operationalising the *Involves others and elicits participation* latent variable (COMP\_F); Comp\_G1 and Comp\_G2 refer to the two item parcels operationalising the *unites and connects followers* latent variable (COMP\_G); Comp\_H1 and Comp\_H2 refer to the two item parcels operationalising the *strengthens and enables followers* latent variable (COMP\_H); and Comp\_I1 and Comp\_I2 refer to the two item parcels operationalising the *manages the internal work unit environment* latent variable (COMP\_I).

Inspection of the magnitude of the modification index values across the two matrices indicated that the two largest modification index values all occurred in **B** and that only these two indices could be regarded as statistically significant (i.e. > 6.64). Thus, over and above the fact that these indices could be used in identifying which fixed parameters could be set free in improving model fit, the absence of a large number of large modification indices also commented favourably on the overall fit of the comprehensive LISREL model. This finding thus tended to garner further support for the finding of close model fit under operational hypothesis 6. This notwithstanding, the highest modification index (18.995) was delivered for the (as-of-yet non-existing) Comp\_B → Comp\_F pathway, which directed attention to the fact that the fit of the graduate leader performance comprehensive LISREL structural model would be statistically significantly (p < .01) improved if a path was added in the model so that the latent *analyses and understands the external and internal work unit environment* graduate leader competency directly effects the latent *involves others and elicits participation* competency. The magnitude and sign of the completely standardised change (.906) associated with adding such a pathway, at least, warranted some consideration.

In reflecting on the implications of adding such a pathway and whether the forging of a new, previously unconsidered, direct causal pathway from the latent *analyses understands the external and internal work unit environment* competency to the latent *involves others and elicits participation* competency would be theoretically justifiable, it was the opinion of the researcher that the addition of such a linkage would not be incompatible with the theoretical base underlying the graduate leader performance structural model. The current graduate leader performance structural model already makes provision for the indirect effect of latent *analyses and understands the external and internal work unit environment* graduate leader competency on the latent *involves others and elicits participation* competency, mediated by the latent *creates an exciting and aspirational vision for the unit* competency and the latent *entrenches a high-performance culture in the unit* competency.<sup>363</sup> The question that needed to be considered was whether the addition of a direct effect, over and above the indirect effect made substantive theoretical sense? The latent *analyses and understands the external and internal work unit environment* competency was defined (and measured) as: *systematically surveys and immerses the self in the internal and external environment of the unit to collect and interpret information about critical occurrences or conditions on behalf of the unit as input to unit performance planning*. Being competent at this competency therefore presupposes that the graduate leader, on one level, engages colleagues, followers, subordinates or managers within the unit in order to collect information on the internal functioning of the team or organisation. It follows that when the graduate leader acts on the information supplied by all of these internal contacts and uses their information as input to performance planning, it is possible that the fact that their information is used and acknowledged in the unit's performance plan could indeed contribute to unit members feeling more involved and determined to participate.<sup>364</sup> At the very least, it is plausible to assume that it would be easier for a leader to make followers feel more involved and to elicit their participation, if their suggestions and the information they bring to the table are acknowledged and acted on in terms of the unit's overall performance plan. The researcher therefore tended to support the theoretical plausibility of adding a new structural path between these competency dimensions, which could be something to consider for future studies (see Chapter 6).

The second significant value encountered on the beta matrix suggested that a new pathway be created in which Comp\_F is allowed to directly affect Comp\_G, which directed attention to the fact that the fit of the graduate leader performance comprehensive LISREL model would be improved (in terms of overall fit) if a path was added in the model from the latent *involves others and elicits participation* graduate leader competency, to the latent *unites and connects followers* competency. The completely standardised change (1.291) associated with adding such a pathway, again warranted some consideration. In reflecting on the possibility of linking these two competency dimensions in such a way, the researcher was again compelled to conclude that this structural linkage was theoretically plausible and that a relationship between these competency dimensions was possibly overlooked when the graduate leader performance structural model was originally conceived. The current model already allows for a complex indirect effect of Comp\_F and Comp\_G.<sup>365</sup> The question is whether a direct effect would make substantive theoretical sense? The rationale for this conclusion is theoretically based and revolves around the fact that both competency dimensions were originally intended to reflect behavioural repertoires to be utilised by leaders in activating positive socio-emotive dynamics in people. Whereas Comp\_F (*involves others and elicits participation*) was intended to reflect a behavioural repertoire that leaders can employ essentially to satisfy followers' higher order esteem needs and to foster in them psychological ownership of their unit and work, Comp\_G (*unites and connects followers*<sup>366</sup>) was intended to reflect a behavioural repertoire that leaders can employ to satisfy the basic human

<sup>363</sup> This indirect effect was statistically significant ( $p < .05$ ).

<sup>364</sup> For ease of reference, the *involves others and elicits participation* competency was defined as *provides scope and opportunities for followers to spontaneously contribute their full talents/capabilities to the unit's performance process*.

<sup>365</sup> The indirect effect of Comp\_F on Comp\_G was, however found to be statistically insignificant ( $p < .05$ ).

<sup>366</sup> For ease of reference, *unites and connects others* was defined as: brings followers together and unites them in fortified, mutually supportive relationships.

desire for forming and maintaining social bonds in order to positively affect team dynamics (i.e. cohesion, trust and communication). It follows that the underlying processes with which people's needs are satisfied in organisations could be related, in that people who feel valued and take ownership of their work and the unit's success are more likely to be more interested in the dealings (i.e. the successes, failures and shared priorities) of others in the unit which, in turn, could make them more amenable to the development and maintenance of positive social interactions with such unit members. At the very least, it is plausible to assume that it would be easier for leaders to facilitate social cohesion, trust and communication between unit members who already feel valued and who are *psychologically connected* to the fate of the unit (and thus all its members). Nonetheless, the modification indices were employed for use in making data-driven suggestions (see Chapter 6) rather than for making any actual structural changes to the graduate leader performance model at this point. Figure 5.22 illustrates the proposed graduate leader performance structural model and highlights the paths that were supported, as well as the paths that were not supported by the data.

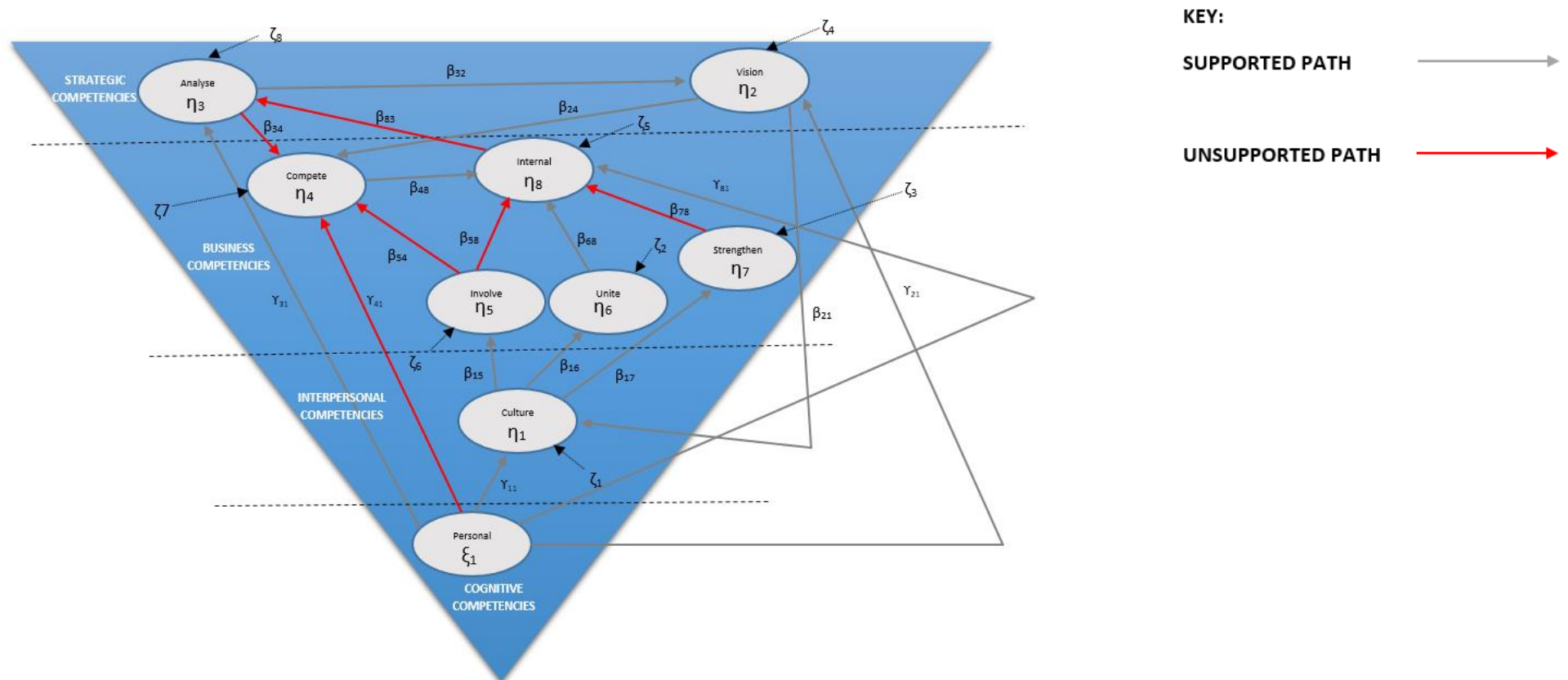

Figure 5.22. The graduate leader performance final structural model

Note: Personal refers to *displays personal leader proficiency*; Culture refers to *entrenches a high-performance culture in the unit*; Involve refers to *involves others and elicits participation*; Unite refers to *unites and connects followers*; Strengthen refers to *strengthens and enables followers*; Internal refers to *manages the internal work unit environment*; Compete refers to *develops unit competitiveness*; Analyse refers to *analyses and understands the external and internal work unit environment*; and Vision refers to *creates an exciting and aspirational vision for the unit*.

### 5.13 CONCLUSION

In this chapter the results of the various statistical procedures were documented and observations made on whether the findings proved or disproved the substantive and operational hypotheses as developed in Chapter 3 (and as was translated from the research objectives in Chapter 1). The results of descriptive statistics, scale analysis and model fit were portrayed. Out of the eighteen path-specific hypotheses proposed in Chapter 3, six could unfortunately not be corroborated. Five path coefficients associated with five path-specific hypotheses were found to be statistically insignificant in the beta matrix, while only one path coefficient associated with one path-specific hypothesis was found to be statistically insignificant in the gamma matrix. In the next chapter the results will be disseminated and critically discussed for the benefit of the reader. Also, the next chapter highlights the managerial implications of the overarching findings on the construct validity of the PGLCQ. Finally, the chapter will conclude with a discussion on the limitations of the present study and recommendations will be made for future research.



## CHAPTER 6: DISCUSSION AND CONCLUSION

### 6.1 INTRODUCTION

The purpose of Chapter 6 is to summarise and synthesise the insights that were gained and learnings that occurred throughout the course of this research project and to provide a comprehensive discussion of its results. The chapter will begin with a review of the research objectives, followed by a brief overview of the study in order to contextualise the forthcoming material for the reader. Next, the results of the study will be presented with specific reference to the item analysis, dimensionality analysis and reliability analysis performed on each of the nine subscales of the PGLCQ, the CFA performed on the PGLCQ measurement model and the fitting of the graduate leader performance comprehensive LISREL model. The chapter will conclude with a discussion on the implications of the findings of the study, its applications, limitations and recommendations for future studies in this niche area of Industrial-Organisational Psychology.

### 6.2 RESEARCH OBJECTIVES

The present study focused on the conceptualisation of the graduate leader performance construct (behaviourally interpreted), the operationalisation of the construct via the Pienaar Graduate Leader Competency Questionnaire (PGLCQ) and the validation of the construct-referenced inferences derived from the dimension scores obtained on the instrument. Initially, the aim was to collect multi-rater data on the graduate leader performance construct via two versions of the PGLCQ. Unfortunately, the challenges associated with obtaining complete responses (i.e. a response was only complete if both a graduate (self-rater version of the PGLCQ) and their manager/supervisor (other-rater version of the PGLCQ) completed the questionnaire), forced the researcher to abandon this plan.

Consequently, a convenience sample of self-rater responses was collected and the research objectives, as formulated in Chapter 1, had to be adapted during the course of the study to accommodate the fact that only self-ratings<sup>367</sup> were eventually utilised in the study's SPSS and SEM procedures. The revised research objectives of the study are presented below:

- a) To explicate the connotative and denotative meaning of the competency domain of the generic graduate leadership performance construct;
- b) To develop the Pienaar Graduate Leadership Competency Questionnaire (PGLCQ) that can be used to obtain self-assessments of the competency domain of the graduate leadership performance construct;
- c) To evaluate the reliability and construct validity of the PGLCQ by evaluating the fit of the measurement model implied by the architecture of the questionnaire and the constitutive definition of the generic graduate leadership performance construct when parcelling is used to operationalise the latent graduate leader competencies measured by the PGLCQ; and
- d) To evaluate the construct validity of the performance measure by evaluating the fit of the structural model reflecting the internal structure attributed in terms of the conceptualisation of the construct to the generic graduate leader performance construct.

---

<sup>367</sup> Note: It is acknowledged that a number of other-rater responses were added to the self-rater responses in order to supplement the eventual sample size of the study. The other-rater responses were treated in the psychometric analyses as if they were no different from the self-rater responses. It is acknowledged that methodologically this is not the ideal approach to the analysis of the data since it ignores rater type as a source of systematic variance in the data.

### 6.3 OVERVIEW OF THE CURRENT STUDY

In Chapter 1 it was argued that the retirement of the baby boomer generation, many of whom represent the (top) leadership cadre of industry today, will place an additional responsibility on HR departments “to create a bench of strength from which to draw future leaders” (Lacey & Groves, 2014, p. 401). More specifically, it was maintained that the impending retirement of a large number of industry’s senior and most influential leaders around the world will increasingly put pressure on HR departments to be able to identify management potential from and accelerate the leadership development of the latest generation to enter the workforce (Generation Y) in order to deliver a supply of high calibre executives and leaders for the future (Doherty et al., 1997). However, it was also argued that Gen Y differs from previous generations in terms of their work-related characteristics (Fairhurst & Shaw, 2008) and that this has significant implications in terms of how HR interventions should be designed and delivered in order to attract, identify, retain and develop (leadership) potential amongst this new generation of employees (Yrle et al., 2005). Numerous potentially value-adding interventions in addition to graduate leadership acceleration programmes were discussed, most notably that HR departments should focus their efforts on influencing the dispositions and attainment domain of new graduates (e.g. assistance in alleviating the graduate employability dilemma) and the graduate motivation and opportunity to contribute domains (e.g. retention strategies focusing on the needs of Gen Y and incorporating the new trend of phased, transactional employment, and the optimisation of their psychological states such as engagement and psychological empowerment).

However, it was also argued that in order to diagnose the causes of low levels of employability amongst graduates emanating from South African universities, to inform the recruitment and selection of graduates as well as their development upon entry into the organisation, and to inform interventions aimed at the development of psychological states that affect (intrinsic) work motivation and lower turnover intention, that in turn, are all necessary prerequisites for the development of effective leadership acceleration programmes, the complex nomological network of latent variables characterising the graduate employee (i.e. transient psychological states, malleable attainments and rather inflexible, non-malleable dispositions) and characterising the work environment (such as job characteristics, job demands and span of control) that affect graduate leader performance and turnover needs to first be validly mapped and understood. Consequently, this broached the questions as to what graduate leader performance means, and secondly, how graduate leader performance could be measured.

The former question was answered by approaching the conceptualising of the graduate leader performance construct from the perspective of a five-domain job performance hypothesis (e.g. a *competency model approach to job performance*) in which the latent variables in the relevant domains are structurally mapped on each other in a richly interconnected network of cause-and-effect relationships. The domains in question are competency potential, (IQ, personality, psychological state, etc.), competencies (the desired behavioural repertoires), competency outcomes (work outcomes), competency requirements (implicit and explicit norms and values guiding behaviour and that are derived from organisational strategy), and job and organisational characteristics (resources or demands that, as main effects or in interaction with competency potential latent variables or in interaction with competencies, increase or diminish an individual’s psychological state, demonstration of behaviours, and achievement of important work outcomes). To diagnose the causes of low levels of employability amongst graduates emanating from South African universities, to inform the recruitment and selection of graduates as well as their development upon entry into the organisation, and to inform interventions aimed at the development of psychological states that affect (intrinsic) work motivation and lower turnover intention, that in turn, are all necessary prerequisites for the development of effective leadership acceleration programmes, the foregoing competency model needs to be explicated and empirically tested. However, as the full explication of such a multidomain hypothesis was considered a massive and overly ambitious undertaking and implied a multiphase project

spanning a considerable amount of time, the focus of the present study was limited to the explication of the behavioural domain of graduate leader performance only (or first). This led to the derivation of a structural model that depicted the hypothesised internal structure of the graduate leader performance construct (behaviourally interpreted) as presented in Chapter 2. More specifically, the identities of nine (second-order) latent competency dimensions were explicated as well as the manner in which these were understood to influence each other (directly and indirectly) as part of a nomological network believed to constitute graduate leader (behavioural) performance.

The explication effort relied on a comprehensive literature review on leadership and managerial effectiveness, as pertaining to the requisite functioning of a leader in an organisation conceived as an 'open system'. Systems theory broadly holds that organisations compete in a broader external environment with others by way of a transformative process during which human and physical resources are extracted (input) and purposefully manipulated (process/technology) to create 'products' (output) that are of value in this same environment. To the extent that these products are valued, the market valuation exceeds the investment required to produce the product or service and subsequent production cycles (offering the same or more novel, valued products) continue to meet changing environmental requirements, the system will (have a functional reason to) continue competing with others. The effectiveness and efficiency with which the transformation process is performed and the way in which it is done will therefore determine whether continued access to the physical (i.e. materials, finances and information) as well as psychological (i.e. commitment, sense of belonging, etc.) resources necessary for the system to prosper and endure will be attained.

The following theoretical subsystems formed part of this analysis and assisted the researcher in exploring how leaders as boundary spanners (Cross et al., 2013) at the helm (Spangenberg & Theron, 2013) of organisations as 'open-systems' can facilitate organisational performance (see Figure 6.1 below):

- The environment that the unit is in constant interaction with comprising of a number of *suprasystems* (i.e. forces, agents, competitors and other role-players functioning outside of the unit's boundaries), most of which may be largely beyond the control of the organisation (Mason, 2007);
- The *strategic subsystem* that regulates how the organisation understands and interacts with its environment;
- The *structural subsystem* constituting elements of organisational design such as span of control, decision-making rights and responsibilities;
- The *technological subsystem* representing the 'throughput' assembly line or work-flow (i.e. the means with which work is organised and carried out as part of the conversion process);
- The *human subsystem* that emerges through interactions among subsystems, the distinctive properties of which are consequences and conditions of the specific interrelationships and resultant interactions among subsystems (and suprasystems); and
- The *managerial subsystem* (i.e. management/leadership) that is tasked with coordinating, adjusting, controlling and directing the other subsystems.

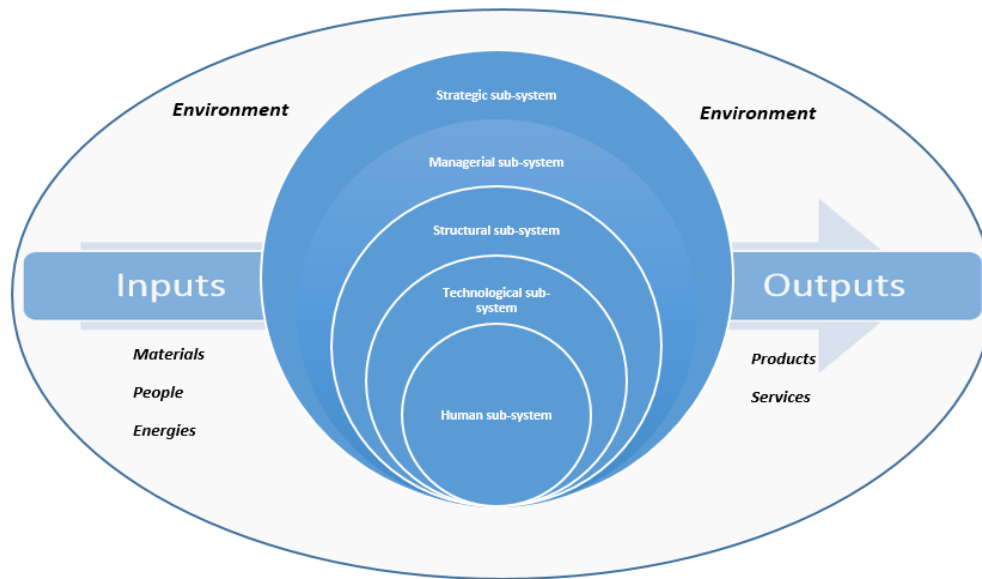

Figure 6.1. A simplified representation of the organisation as an open system

Grounded in an extensive literature review, the researcher thus embarked on a 'no-holds barred' explication effort that systematically grappled with each of the subsystems that a work unit comprises of to extract the important variables relevant to a leader's potential contribution in eliciting unit performance in support of the formulation of a new taxonomy towards this end. This process resulted in the extraction of more than one hundred (first-order) latent graduate leader competencies. Moreover, the pure high number of competencies eventually extracted from this framework necessitated further investigation as to the possibility of the existence of a more parsimonious, second-order competency structure. As the large number of first-order competencies that were derived created an almost unsurmountable logistical challenge to collect data on all of them, which in effect precluded the use of exploratory factor analysis as a technique to explore their possible second-order structure, the researcher consequently employed the technique of thematic analysis to group the first-order competencies into nine internally consistent behavioural themes (second-order competencies) instead (Creswell, 2007). The connotative meaning of the graduate leader performance construct was firstly explicated by writing constitutive definitions of each of these second-order latent graduate leader competencies that captured the common theme shared by the first-order latent graduate leader competencies that loaded onto it. The second-order competencies that resulted from the thematic analysis, and their constitutive definitions, are presented in Table 6.1 below. The connotative meaning of the graduate leader performance construct was secondly explicated by theorising specific causal relations between the nine second-order latent graduate leader competencies, thereby attributing a specific internal structure to the graduate leader performance construct. The proposed graduate leader structural model reflecting the hypothesised interrelationships between these aforementioned latent competency dimensions are also presented in Figure 6.2 below.

The question as to how graduate leader performance could be measured, on the other hand, was dealt with by developing an instrument (i.e. the PGLCQ) that could be used to measure these nine second-order competencies. In order to do so, the researcher firstly consulted with a number of subject-matter experts in this area in order to gain their consensus that the second-order graduate leader competencies gleaned from the literature study and that were lined up for use in the PGLCQ could indeed be confirmed as contemporary behavioural performance requirements of (graduate) leaders in the world of work. Subject matter experts were also probed to determine

whether the proposed graduate leader performance construct suffered from construct deficiency insofar as it ignored relevant latent graduate leader competencies.

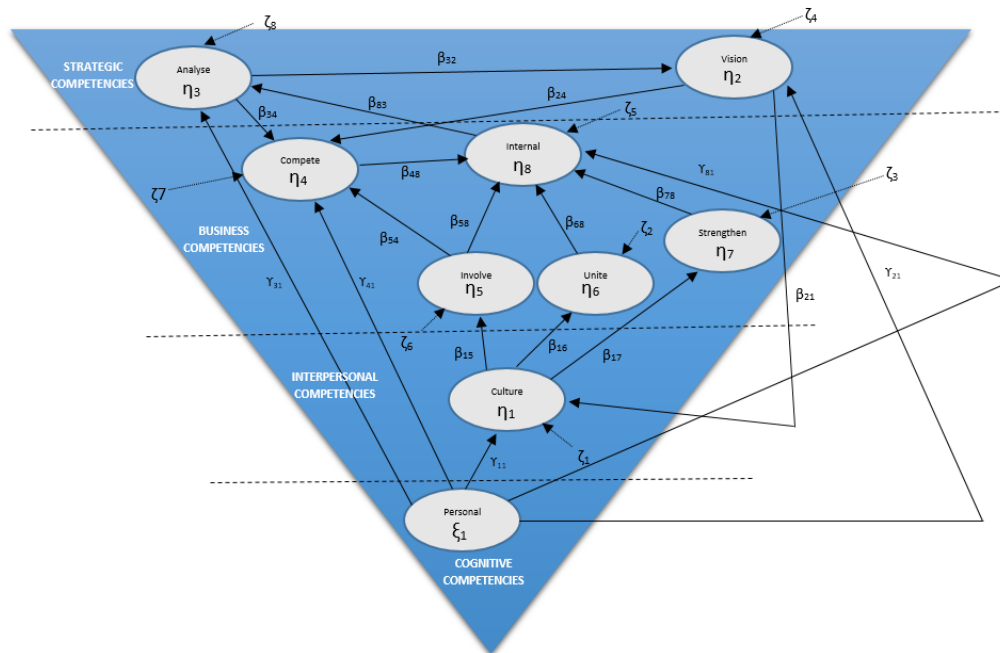

Figure 6.2. Operationalised graduate leader competency domain structural model imposed on the Leadership Strataplex schematics<sup>368</sup>

Fortunately, there was consensus right from the start regarding the importance of these second-order competencies and the panel also agreed that the theoretical graduate leader competency domain model did not suffer from construct contamination. The panel in addition agreed that the proposed graduate leader performance construct did not suffer from construct deficiency.

The Critical Incident Technique (Flanagan, 1954) was used to generate behavioural denotations of the nine second-order latent graduate leader competencies. The researcher again approached these same subject matter experts, referred them to the constitutive definition of a specific, second-order (graduate) leader competency, and asked them to think of a graduate that they considered to be one of the best performers on this competency that they know or have known before. Participants were given the constitutive definition of the competency under discussion (again) and were then asked to justify their choice of graduate by describing the specific (behavioural) incidents that illustrated the graduate's proficiency on the second-order competency under investigation. Moreover, all panellists were requested to provide examples of critical behaviours signifying a high or low standing on all nine of the explicated second-order graduate leader competencies, thereby providing for a rich and extensive experimental databank from which to commence item generation for the PGLCQ. The PGLCQ eventually comprised of 90 questions (10 questions per competency)<sup>369</sup> and utilised 5-point rating scales. The five response options were: well below standard; below required standard; satisfactory; above required standard; and well above standard, were anchored with behavioural vignettes that typify each response option as a level of competence on the specific latent graduate leader competency (see

<sup>368</sup> Note: Personal refers to *displays personal leader proficiency*, Culture refers to *entrenches a high-performance culture in the unit*, Involve refers to *involves others and elicits participation*, Unite refers to *unites and connects followers*, Strengthen refers to *strengthens and enables followers*, Compete refers to *develops unit competitiveness*, Internal refers to *manages the internal work unit environment*, Analyses refers to *analyses and understands the external and internal work unit environment*, and Vision refers to *creates an exciting and aspirational vision for the unit*.

<sup>369</sup> These questions were used to rate the nine second-order competencies. In addition to this, each version of the PGLCQ also included a number of biographical questions.

Appendix A). Participants were also given a sixth response option (cannot rate) for cases where they felt that they were not able to accurately rate a graduate on specific item.

Table 6.1

*The second-order competencies of the graduate leader performance construct*

SECOND-ORDER COMPETENCY	LEVEL	SECOND-ORDER COMPETENCY DESCRIPTION.
1 Analyses and understands the external and internal work unit environment	STRATEGIC	Systematically surveys and immerses the self in the internal and external environment of the unit to collect and interpret information about critical occurrences or conditions on behalf of the unit as input to performance planning
2 Creates an exciting and aspirational vision for the unit	STRATEGIC	Attracts and rallies a wide follower base towards an inspiring and exciting future vision of what can be achieved and how their lives can be fulfilled and become more meaningful by joining and investing in such a cause
3 Develops unit competitive ability	BUSINESS	Develops and secures resources for exploiting viable, eco-friendly and sustainable opportunities necessary for the occupation of a morally superior, winning market position
4 Entrenches a high-performance culture in the work unit	INTERPERSONAL	Consistently behaves and makes decisions in a manner that serves the human condition by eliciting positively valenced psychological functioning in followers
5 Involves others and elicits participation	BUSINESS	Provides scope and opportunities for followers to spontaneously contribute their talents/capabilities
6 Unites and connects followers	BUSINESS	Brings followers together and unites them in fortified, mutually supportive relationships
7 Strengthens and enables followers.	BUSINESS	Raises the confidence and performance capabilities of followers towards success and high levels of achievement.
8 Manages the internal work unit environment	BUSINESS	Maintains a hands-off procedural view and executes in-process corrections as and when required to ensure that different components of the conversion process keep pulling in the same direction
9 Displays personal leader proficiency	COGNITIVE/INTERPERSONAL	Functions as a well-rounded, sought-after and high-impact resource

## 6.4 DISCUSSION OF RESULTS

The psychometric evaluation of the nine subscales of the PGLCQ by way of item and dimensionality analysis delivered results that were compatible with the position that all of them provided an adequate measure of the specific latent competency variables they were designed to assess (i.e. acceptable evidence was obtained to conclude their reliability and validity). It must be noted, though, that factor fission occurred when the *develops unit competitiveness*, *unites and connects followers*, and the *manages the internal work unit environment* subscales were initially fitted via LISREL as evidenced by their lack of fit in the parameter. From the subsequent exploratory factor analysis conducted via SPSS it was clear that there were two factors underlying each of these three subscales. However, it was also demonstrated that the factor fission that occurred here was meaningful in the sense that in the case of each of these subscales, both extracted factors still represented logical facets of the underlying competency dimension that each subscale was originally designed to measure. The different items measuring factor 1 and factor 2 in each case, were accordingly acknowledged to be and treated as subtests of a higher-order competency still representing their original 'theme'. Put differently, it was argued that the two-factor structure underlying each of these three subscales simply measured two different strata of the latent competency variable (as originally defined) in question, and not two separate measures of two unrelated constructs. For this reason, the measurement intent of these subscales and the operationalisation of these latent competency dimensions were still regarded as successful, despite the fact that unanticipated factor fission had occurred here. In the case of the three subscales where factor fission was found, second-order measurement models were fitted and the statistical significance of the indirect effect of the second-order factor on the subscale items were evaluated. In the case of all three subscales the second-order factors were found to statistically significantly ( $p < .05$ ) indirectly affect the item responses, mediated by the two extracted first-order factors. This warranted the (interim and long-term) use of the dimension scores obtained for these three subscales as indicators of the second-order factor over and above the (interim) use of the total scores calculated from the two item subsets as indicators of the first-order factors.

The reliability coefficients of the different subscales of the PGLCQ, on the other hand, are presented in Table 6.2 (McDonald's omega) and Table 6.3 (Stratified alpha) below.

Table 6.2

### *McDonald's omega coefficients for the single-factor PGLCQ subscales*

One-factor Subscale	$\Omega$
COMP_A:	.851
COMP_B:	.895
COMP_C:	.921
COMP_D:	.884
COMP_F:	.850
COMP_H:	.921

Note: Comp\_A refers to the displays personal leader proficiency subscale, Comp\_B refers to the analyses and understands the external and internal work unit environment subscale, Comp\_C refers to the creates an exciting and aspirational vision for the unit subscale, Comp\_D refers to the creates a high-performance culture for the unit subscale, Comp\_F refers to the involves others and elicits participation subscale, Comp\_H refers to strengthens and enables others subscale.

Table 6.3

### *Stratified alpha coefficients for the two-factor (composite) PGLCQ subscales*

Composite (two-factor) Subscale	Stratified $\alpha$
COMP_E:	.909
COMP_G:	.882
COMP_I:	.921

Note: Comp\_E refers to the develops unit competitiveness subscale, Comp\_G refers to the unites and connects others subscale, and Comp\_I refers to the manages the internal work unit environment subscale.



The subsequent fitting of the PGLCQ measurement model led to the conclusion of close fit in the parameter (RMSEA = .057;  $p > .05$ ). The fitted PGLCQ competency questionnaire measurement model also did not over- or underestimate any of the 171<sup>370</sup> variances and covariances observed in the covariance matrix, which commented favourably on its fit as well. In addition, as the LISREL output suggested that the item parcels of the PGLCQ competency questionnaire measurement model loaded satisfactorily ( $\lambda_{ij} \geq .78$ ) and significantly ( $p < .05$ ) on the latent variables they were earmarked to reflect, and the PGLCQ measurement model passed all tests of discriminant validity (i.e. screening of the phi matrix, AVE values for all of the latent competency dimensions surpassed the .50 cut-off and was also found to be larger than the squared correlations between the latent competency dimensions, none of the 36 95% confidence intervals for the phi estimates included unity), the operationalisation of the latent variables that the graduate leader structural model comprises of was considered successful.

When fitting graduate leader performance comprehensive LISREL model, although close fit was not obtained in the parameter, the model fit was nonetheless evaluated as sufficiently reasonable to warrant the interpretation of the structural model parameter estimates. Acceptable model fit was concluded as, despite the fact that the exact ( $\chi^2 = 191.705$ ;  $p < .05$ ) and close fit hypotheses (RMSEA = .069;  $p < .05$ ) both had to be rejected, the NNFI, CFI and SRMR indices under Hu and Bentler's (1999) Two-Index Presentation strategy combination rules provided sufficient evidence to argue that the fitted model was able to sufficiently accurately approximate the observed variance-covariance matrix. The conclusion of acceptable fit was corroborated by the residual output, which again confirmed that the fitted comprehensive LISREL model did not significantly ( $p < .01$ ) over- or underestimate any of the 171 variances and covariances observed in the covariance matrix (0%). The evidence garnered on model fit justified the interpretation of the various structural model parameter estimates (as reported by the  $\Gamma$ ,  $B$ , and  $\Psi$  matrices) and  $R^2$  values of the endogenous latent competency variables.

Out of the eighteen path-specific hypotheses proposed in Chapter 3, six could unfortunately not be corroborated. Five path coefficients associated with five path-specific hypotheses were found to be statistically insignificant ( $p > .05$ ) in the beta matrix, while only one path coefficient associated with one path-specific hypothesis was found to be statistically insignificant ( $p > .05$ ) in the gamma matrix. The signs of all of the statistically significant  $\lambda$  and  $\beta$  parameters were also found to be consistent with the hypothesised relationships between the latent competency dimensions in question, resulting in the rejection of the following path-specific null hypotheses:  $H_{077}: \gamma_{11} = 0$ ,  $H_{078}: \gamma_{21} = 0$ ,  $H_{079}: \gamma_{31} = 0$ ,  $H_{081}: \gamma_{81} = 0$ ,  $H_{082}: \beta_{71} = 0$ ,  $H_{083}: \beta_{61} = 0$ ,  $H_{084}: \beta_{51} = 0$ ,  $H_{087}: \beta_{84} = 0$ ,  $H_{089}: \beta_{86} = 0$ ,  $H_{092}: \beta_{23} = 0$ ,  $H_{093}: \beta_{12} = 0$  and  $H_{094}: \beta_{42} = 0$ . Support was therefore obtained for the following path-specific substantive hypotheses: Path-specific substantive hypothesis 1 ( $\lambda_{11}$ ), path-specific substantive hypothesis 2 ( $\lambda_{21}$ ), path-specific substantive hypothesis 3 ( $\lambda_{31}$ ), path-specific substantive hypothesis 5 ( $\lambda_{81}$ ), path-specific substantive hypothesis 6 ( $\beta_{71}$ ), path-specific substantive hypothesis 7 ( $\beta_{61}$ ), path-specific substantive hypothesis 8 ( $\beta_{51}$ ), path-specific substantive hypothesis 11 ( $\beta_{84}$ ), path-specific substantive hypothesis 13 ( $\beta_{86}$ ), path-specific substantive hypothesis 16 ( $\beta_{23}$ ), path-specific substantive hypothesis 17 ( $\beta_{12}$ ), and path-specific substantive hypothesis 18 ( $\beta_{42}$ ). In addition, the strength of the all of the statistically significant ( $p < .05$ ) path coefficients were found to be of a satisfactory (moderate to strong) magnitude (i.e. between .395 and .916) and in the appropriate direction.  $H_{080}: \gamma_{41} = 0$ ,  $H_{085}: \beta_{45} = 0$ ,  $H_{086}: \beta_{43} = 0$ ,  $H_{088}: \beta_{87} = 0$ ,  $H_{090}: \beta_{85} = 0$  and  $H_{091}: \beta_{38} = 0$  in turn, could not be rejected. Support was therefore not obtained for the following path-specific substantive hypotheses: Path-specific substantive hypothesis 4 ( $\lambda_{41}$ ), path-specific substantive hypothesis 9 ( $\beta_{45}$ ), path-specific substantive hypothesis 10 ( $\beta_{43}$ ), path-specific substantive hypothesis 12 ( $\beta_{87}$ ), path-specific substantive hypothesis 14 ( $\beta_{85}$ ) and path-specific substantive hypothesis 15 ( $\beta_{38}$ ).

---

<sup>370</sup>  $(18 \times 19)/2 = 342/2 = 171$

The support garnered for these path-specific operational hypotheses, however, did not mean that the causal claims made by them were unequivocally accepted. Rather, these results only provided support in the sense that these causal claims survived an opportunity to be refuted. In addition, the researcher also duly acknowledges that these findings of reasonable or acceptable model fit did not mean that the fitted structural model necessarily provided the only solution in terms of explaining the mechanism underlying graduate leader performance, but simply that it provided one plausible (and convincing) explanation for the process that regulates the behavioural repertoires underlying graduate leader performance. For ease of reference, Figure 6.3 below illustrates the proposed graduate leader performance structural model that highlights the paths that were supported and that were not supported (in terms of statistical significance) by the data, and the effect sizes of the statistically significant paths.

In interpreting these findings, it should be kept in mind that the statistically significant ( $p < .05$ ) as well as the statistically insignificant ( $p > .05$ ) path coefficients should be interpreted as partial regression coefficients. In the case of the statistically significant ( $p < .05$ ) path coefficients it therefore means that support has been found for a very specific claim that  $\xi_j$  affects  $\eta_i$  when the other latent variables that are structurally linked to  $\eta_i$  are held constant (i.e. when their effect is statistically controlled) and that support has been found for a very specific claim that  $\eta_j$  affects  $\eta_i$  when the other latent variables that are structurally linked to  $\eta_i$  are held constant. No unconditional claims that  $\xi_j$  affects  $\eta_i$  or that  $\eta_j$  affects  $\eta_i$  can be justified in terms of these results. Likewise, in the case of the statistically insignificant ( $p > .05$ ) path coefficients it therefore means that support has not been found for a very specific claim that  $\xi_j$  affects  $\eta_i$  when the other latent variables that are structurally linked to  $\eta_i$  are held constant (i.e., when their effect is statistically controlled) and that support has not been found for a very specific claim that  $\eta_j$  affects  $\eta_i$  when the other latent variables that are structurally linked to  $\eta_i$  are held constant. It cannot unconditionally be claimed that  $\xi_j$  does not affect  $\eta_i$  or that  $\eta_j$  does not affect  $\eta_i$ , unless no additional latent variables have been structurally linked with  $\eta_i$ <sup>371</sup>.

The empirical findings stood in support of the following relationships in the gamma matrix:

- Path-specific substantive hypothesis 1: A high level of *personal leader proficiency* ( $\xi_1$ ) will improve leadership effectiveness in *entrenching a high-performance culture in the unit* ( $\eta_1$ );
- Path-specific substantive hypothesis 2: A high level of *personal leader proficiency* ( $\xi_1$ ) will improve leadership effectiveness in *creating an exciting and aspirational vision* ( $\eta_2$ );
- Path-specific substantive hypothesis 3: A high level of *personal leader proficiency* ( $\xi_1$ ) will improve leadership effectiveness in *analysing and understanding the external and internal work unit environment* ( $\eta_3$ ); and
- Path-specific substantive hypothesis 5: A high level of *personal proficiency* ( $\xi_1$ ) will improve leadership effectiveness in the *management of the unit's internal environment* ( $\eta_8$ ).

These results made intuitive sense when evaluated against the leadership strataplex of Mumford et al. (2017) and the Leadership Code of Ulrich et al. (2008) in that primary leadership competencies (i.e. cognitive and interpersonal), which are essentially what the *displays personal leader proficiency* second-order competency dimension was designed to represent, are often described as the cornerstone of leadership competency requirements and it is held that the “majority of leadership activities draw heavily upon these primary skills “(Mumford et al., 2007,

<sup>371</sup> The second-order competencies that constitute the graduate leader performance construct are unique to the current study. Comparison of the current study's research findings on the hypothesised internal structure with findings made in previous research studies therefore become rather difficult if not impossible. Nonetheless, if such comparisons were possible the point argued here becomes extremely important. Strictly speaking, findings on the relationship between  $\xi_j$  and  $\eta_i$  or between  $\eta_j$  and  $\eta_i$  made in different studies are not comparable if these studies not also control for the same additional latent variables linked to  $\eta_i$ .

p. 157). Ulrich et al. (2008) in fact contend that at the heart of leadership, literally and figuratively – is personal proficiency. Hence, these results corroborated earlier research according to which cornerstone competencies are considered to be the critical ingredients for enhancing proficiency across the full spectrum of leadership competence (Ulrich et al., 2008). In contrast, however, the lack of support for path-specific hypothesis 4, was surprising and not anticipated. The fact that high levels of *personal leader proficiency* did not (directly) influence the *develops unit competitiveness* competency dimension in a positive manner (when controlling for the effect of the latent *involves others and elicits participation* graduate leader competency) thus contradicted the ‘cornerstone’ argument and unfortunately did not make intuitive sense either. It seems more plausible that leaders who display superior ability in terms of their personal competence in greatly contributing to the performance and success of their units/teams would tend to be more competent in the creation of effective performance plans that can bolster their performance and the performances of their team members as well.

The lack of support for path-specific hypothesis 4, however, was made less disconcerting by the fact that the indirect effect of the *displays personal leader proficiency* dimension on the *develops unit competitiveness* dimension via the *creates an exciting and aspirational vision for the unit* dimension, still allowed for *personal leader proficiency* to effect *develops unit competitiveness*, albeit indirectly. The indirect effect of the latent graduate leader competency (Comp\_A) on the latent *develops unit competitiveness* graduate leader competency (Comp\_E), was found to be statistically significant ( $p < .05$ ).<sup>372</sup> A lasting fault with this line of reasoning nonetheless remained because the *develops unit competitiveness* variable was ultimately not adequately explained by the structural model. This was evidenced by the fact that it was one of the variables for which the least amount of variance was explained by the model (i.e. 58%) and this was also the variable for which support for the most path-specific hypothesis (running into it) could not be obtained.

The subscale that was developed to measure the latent *develops unit competitiveness* graduate leader competency (Comp\_E) suffered from factor fission. The two factors that were extracted were interpreted as a more traditional understanding of organisational competitiveness in terms of the output (e.g. process performance, profit, product/service output) delivered in the unit and the extent to which the graduate’s contributions to a unit’s performance strategy stimulated such output (factor 1), while factor 2 was interpreted in terms of a more recent conceptualisation of organisational competitiveness and performance (or business) strategy focusing on aspects such as sustainability, conservation and constituent welfare, and how the graduate’s contributions to a unit’s performance strategy brought about such outcomes.

This in turn raises the question of whether the latent *displays personal leader proficiency* graduate leader competency has been conceptualised (functions as a well-rounded, sought-after and high impact resource in my unit (team)) and operationalised sufficiently broadly to encompass proficiency in actions explicitly aimed at more progressive interpretations of unit competitiveness such as sustainability, conservation and constituent welfare. The latent *displays personal leader proficiency* graduate leader competency has seemingly been conceptualised and operationalised rather vaguely without explicit reference to areas in which leadership proficiency is displayed.

---

<sup>372</sup> LISREL 8.8 combines all indirect effects into a single evaluation of the statistical significance of the indirect effect. In the current case there are at least three paths through which Comp\_A indirectly affects Comp\_E. Some of these paths contain statistically insignificant ( $p > .05$ ) (as well as statistically significant;  $p < .05$ ) path coefficients, but that does not necessarily imply that the specific indirect path is statistically insignificant ( $p > .05$ ).

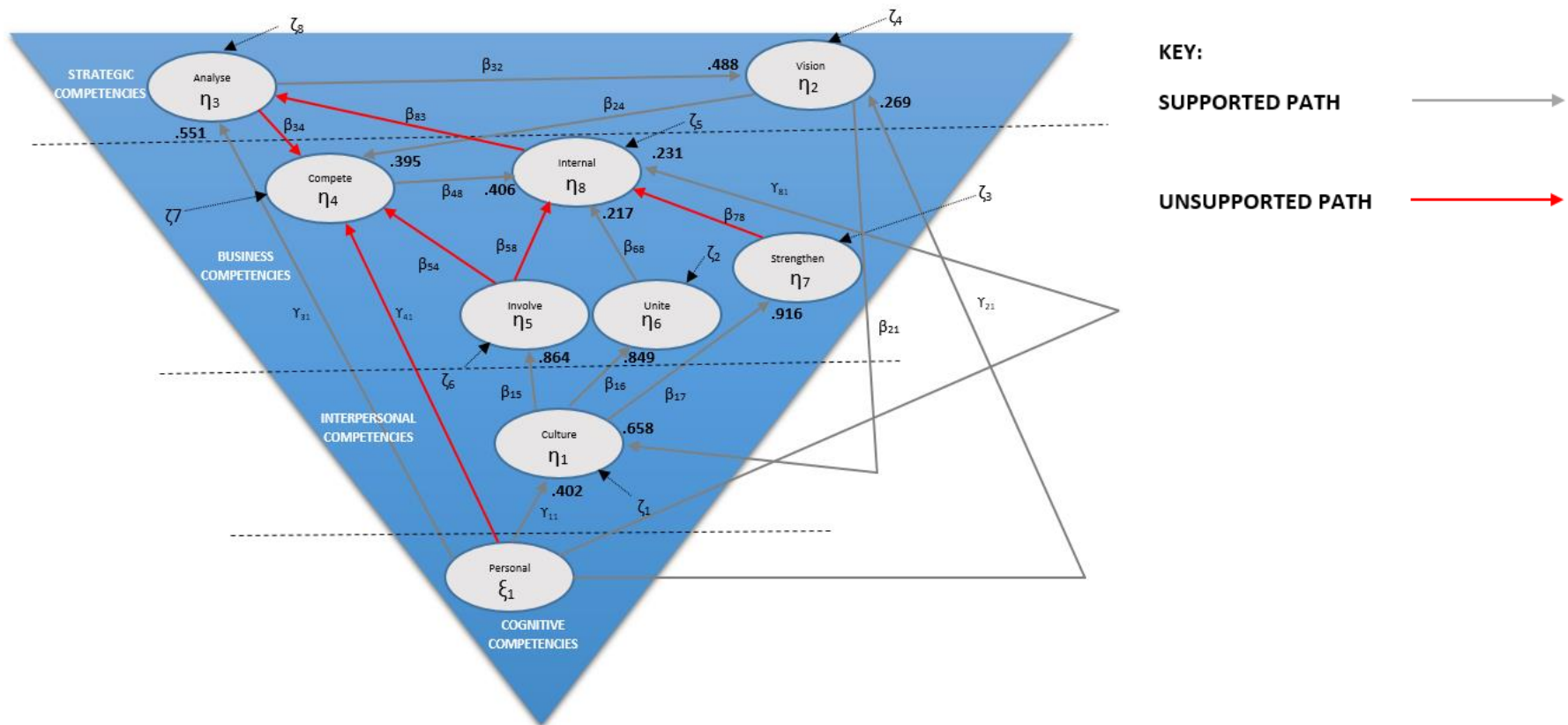

Figure 6.3. Support for the attributed internal structure of the graduate leader performance construct with effect sizes

Note: Personal refers to *displays personal leader proficiency*, Culture refers to *entrenches a high-performance culture in the unit*, Involve refers to *involves others and elicits participation*, Unite refers to *unites and connects followers*, Strengthen refers to *strengthens and enables followers*, Internal refers to *manages the internal work unit environment*, Compete refers to *develops unit competitiveness*, Analyse refers to *analyses and understands the external and internal work unit environment*, and Vision refers to *creates an exciting and aspirational vision for the unit*.

The reliability of the Comp\_E subscale (as reflected in the Stratified alpha), the good fit of the first-order and second-order two-factor measurement models and the statistical significance ( $p < .05$ ) of the indirect effect of the second-order factor on the subscale items presented no psychometric explanations for the lack of support for the direct effect hypothesis. Neither did the Comp\_A subscale items raise any serious psychometric concerns that could be used to explain the insignificant direct effect.

This suggests the possibility that the way that the *develops unit competitiveness* competency dimension was positioned in the model oversimplified the psychological mechanism at work here and that it might be that competency potential variables (like for example high levels of cognitive complexity<sup>373</sup> or emotional intelligence (EQ)<sup>374</sup>) needed to be brought into play in interaction with *develops unit competitiveness* as well.

The empirical findings also stood in support of the following relationships in the beta matrix:

- Path-specific substantive hypothesis 6: High proficiency in the *entrenchment of a high-performance culture* ( $\eta_1$ ) will improve leadership effectiveness in *strengthening and enabling followers* ( $\eta_7$ );
- Path-specific substantive hypothesis 7: High proficiency in the *entrenchment of a high-performance culture* ( $\eta_1$ ) will improve leadership effectiveness in *uniting and connecting followers* ( $\eta_6$ );
- Path-specific substantive hypothesis 8: High proficiency in the *entrenchment of a high-performance culture* ( $\eta_1$ ) will improve leadership effectiveness in *involving others and eliciting participation* ( $\eta_5$ );
- Path-specific substantive hypothesis 11: High proficiency in *developing unit competitiveness* ( $\eta_4$ ) will improve leadership effectiveness in *managing the unit's internal environment* ( $\eta_8$ );
- Path-specific substantive hypothesis 13: High proficiency in *uniting and connecting followers* ( $\eta_6$ ) will improve leadership effectiveness in *managing the unit's internal environment* ( $\eta_8$ );
- Path-specific substantive hypothesis 16: High proficiency in *analysing and understanding the external and internal work unit environment* ( $\eta_3$ ) will improve leadership effectiveness in the *creation of an exciting and aspirational vision* ( $\eta_2$ );
- Path-specific substantive hypothesis 17: High proficiency in the *creation of an exciting and aspirational vision* ( $\eta_2$ ) will improve leadership effectiveness in *entrenching a high-performance culture in the unit* ( $\eta_1$ ); and
- Path-specific substantive hypothesis 18: High proficiency in the *creation of an exciting and aspirational vision* ( $\eta_2$ ) will improve leadership effectiveness in *developing the unit's competitiveness* ( $\eta_4$ ).

---

<sup>373</sup> It could be that the level of cognitive competence required at the level where a leader personally impacts on unit/team leader performance is not excessively high, while the level of cognitive competence required in the development of unit competitiveness is (such as anticipating industry trends, projecting customer needs or budgeting forecasts). The Leadership Strataplex theorem in fact concedes this point by maintaining that cognitive competencies need to be developed to higher levels of proficiency as the leader progresses up the organisational ladder. Therefore, it is possible that individuals that innately have more potential for cognitive complexity would be less rigid in their world-views, be more comfortable with reframing complex problems, and find it easier to make more realistic projections over the long term, which in turn, would tend to make them more effective in the development of unit competitiveness when functioning at a more strategic level in the organisation.

<sup>374</sup> Similarly, it is also plausible that the level of interpersonal skills required at a level where a leader personally impacts on unit/team performance is not excessively high, while the level and depth of interpersonal skills required in developing unit competitiveness is (such as brokering resources, persuading sponsors, donors, or constituents or negotiating mergers) is. Therefore, individuals that have a higher level of innate EQ might find it easier to navigate such encounters and relationships effectively, which in turn, would tend to make them more effective in the development of unit competitiveness when functioning at a more strategic level in the organisation.

Several specific themes emerged from these findings, a review of which will comprehensively cover the implications of both the corroborated and uncorroborated path-specific hypotheses in the beta matrix. In attending to the first of these themes, it was gratifying to observe that all of the *entrenches a high-performance culture* dimension's hypothesised effects in terms of its designated position in the model, and its hypothesised causal relationships with other latent variables in it, were supported by the data. In fact, it was found that the *entrenches a high-performance culture* latent competency variable had the most pronounced effects overall in terms of its designated paths to other variables in the graduate leader performance competency model. This was evident in the statistically significant effect estimates delivered for the *entrenches a high-performance culture* latent competency variable on the other latent competency variables of *involves others and elicits participation* (.864), *unites and connects followers* (.849), and *strengthens and enables followers* (.916) competency dimensions respectively. These findings meant that a leadership style incorporating more employee-centric features, which was exactly what the *entrenches a high-performance culture* competency dimension aimed to capture, operated to create fertile grounds for uniting, involving and strengthening others in the unit. This corroborated an extensive body of related knowledge in support of the relationship between the employment of effective leadership styles (individual consideration, inspirational motivation, ethical behaviour and serving others) and a number of related positive outcomes at both the team and individual level of analysis, such as increased levels of commitment to organisational goals (Bono & Judge, 2003; Podsakoff, MacKenzie, & Bommer, 1996), group cohesiveness (Carron, Spink, & Prapavessis, 1997; Shamir, House, & Arthur, 1993; Yukelson, 1997), group potency (Avolio, Bass, Jung, & Berson, 2003) collective efficacy (Kark, Shamir, & Chen, 2003), job performance (Judge, Picollo, & Ilies, 2004; McCann, Graves, & Cox, 2014), organisational citizenship behaviours, (Podsakoff et al., 1996; Purvanova, Bono, & Dziewieczynski, 2006), psychological empowerment (Avolio, Zhu, Kho, & Bhatia, 2004), and feelings of self-efficacy (Conger & Kanungo, 1988), self-worth and self-determination (Connell, Deci, & Ryan, 1989).

With regard to the second theme, the support obtained for path-specific hypothesis 18 (and lack of support for path-specific hypothesis 10)<sup>375</sup> diverted attention to the much-publicised importance of effective environmental scanning and the link between environmental scanning, and a unit's ability to compete effectively in its environment. The rationale here of course is that "organisations (or leaders as the managers of them) scan the environment in order to understand the... forces of change so that they may develop effective responses, which secure or improve their position in the future" (Choo, 2002, p. 84). Information is collected about events, trends and shifts in the unit's internal and external environment in order to avoid surprises, identify threats and opportunities, and improve short-term and long-term planning to gain competitive advantage (Sutton, 1988). However, the effect of the *analyses and understands the external and internal work unit environment* competency dimension, which essentially intended to capture the environmental scanning function, on the competency dimension of *develops unit competitiveness* could not be corroborated with the data. This finding unfortunately therefore defied logic to some degree. It also contradicted the popular view that an organisation's overall business strategy is related to the sophistication, scope and intensity of its environmental scanning capability (Choo, 2001). The positive effect that the *analyses and understands the external and internal work unit environment* competency had on the *creates an exciting and aspirational vision for the unit* competency dimension, however, was a cause for reassurance in this regard. Accordingly, the *analyses and understands the external and internal work unit environment* competency dimension still affected the *develops unit competitiveness* competency dimension via the *entrenches a high-performance culture in the unit* competency dimension indirectly.<sup>376</sup> This confirmed the position

<sup>375</sup> Path-specific substantive hypothesis 10: In the proposed graduate leadership@work competency domain structural model it is hypothesised that high proficiency in *analysing and understanding the external and internal work unit environment* (Comp\_B;  $\eta_3$ ) will improve leadership effectiveness in *developing the unit's competitiveness* (Comp\_E;  $\eta_4$ )

<sup>376</sup> There is an additional, longer, indirect effect in which *analysing and understanding the environment* (Comp\_B) affects *creates an exciting and aspirational vision for the unit* (Comp\_C) that affects *entrenches a high-performance culture in the unit* (Comp\_D) that affects *involves others and elicits participation* (Comp\_F) that affects *developing the unit's*

that an effective vision is the most important element (Merrit, 2009) of and a precursor to the strategic planning process of a unit (Desai, 2000; Swanson & Torraco, 1995; Theron & Spangenberg, 2005) but still left some questions as to why the *analyses and understands the external and internal work unit environment* competency dimension did not positively impact on the *develops unit competitiveness* competency dimension directly by itself as well (when controlling for the indirect effect).

Gilliland and Tynan (1997) provide a possible explanation for this finding that relates to the state of unpredictability characterising the external environment (i.e. accelerated change and increasing complexity) of the world of work of today. The authors contend that the extent of change and complexity in the external environment is not comprehensible by any single individual anymore, and that this alters the fundamental nature of the leadership model that will produce organisational success, now and in the future. Because of this, they argue that the responsibility for finding solutions for the future will need to reside in the collective of the organisation, and not with any singular individual. Nonetheless, the graduate leader performance structural model did not control for the situational latent variable of environmental predictability, which could account for the uncorroborated pathway of the *analyses and understands the external and internal work unit environment* competency dimension on the *develops unit competitiveness* competency dimension. Thus, it is posited that the pathway was not corroborated because of the possibility that high levels of unpredictability in the external environment actually constrain (mediate negatively) a leader's ability in utilising information obtained there to positively impact unit competitiveness. However, as an abstract, broader concept epitomising a more desirable future, it is argued that environmental unpredictability does not limit the leader's ability for creating an effective vision in the same way as is the case with developing unit competitiveness, which could be the reason why the path from *develops an effective vision for the unit* on the *develops unit competitiveness* competency dimension was corroborated and the path from the *analyses and understands the external and internal work unit environment* on the *develops unit competitiveness* competency dimension was not.

The uncorroborated pathway of the *involves others and elicits participation* competency dimension on the *develops unit competitiveness* competency dimension is a further aspect of this theme that deserves more in-depth consideration. Initially, the psychological mechanism thought to underpin leadership effectiveness in this area hinged on the idea that *develops unit competitiveness* would be positively influenced by the *analyses and understands the external and internal work unit environment*, *displays personal leader proficiency*, *creates an exciting and aspirational vision for the unit* and the *involves others and elicits participation* competency dimensions. Thus, it was argued that superior personal competence (cornerstone leadership competencies), coupled with effective environmental scanning (as input to performance planning), the development of an effective vision for the unit (as the guiding force of the performance plan), and the active involvement of staff (providing their unique perspectives and input on competitiveness from within) would bolster leadership competence in the development of unit competitiveness. While the pathways of the *displays personal leader proficiency*, *creates an exciting and aspirational vision for the unit*, and *analyses and understands the external and internal work unit environment* competency dimensions on the *develops unit competitiveness* competency dimension have already been covered, the fact that the *involves others and elicits participation* competency dimension on the *develops unit competitiveness* did not achieve statistical significance was a further cause for concern.

This relationship was motivated by the assumption that proficiency in the identification and coordination of complications in real-time operations can enrich the analytics derived from internal scanning that is part of a larger environmental scanning exercise where leaders consider

---

*competitiveness* (Comp\_E). The last leg of this indirect effect was found to be statistically insignificant ( $p > .05$ ). The indirect effect of *analyses and understands the external and internal work unit environment* (Comp\_B) on *develops unit competitiveness* (Comp\_E) was found to be statistically significant ( $p < .05$ ).

the constraints and opportunities of both the internal and external environments of the unit. It seems unlikely that a leader/manager who is successful in orchestrating the day-to-day operations and who keeps their finger on the 'pulse' of the unit's operations would not extract any competitive intelligence in support of superior ability in the *analyses and understands the external and internal work unit environment* competency variable as part and parcel of this function as well. One possible explanation for this is that the outcome variable of *environmental analytics*, identified in Chapter 2 as an outcome variable of both the *manages the internal work unit environment* and *analyses and understands the external and internal work unit environment* competency dimensions, that in turn, was also proposed to bolster competence on both of these competencies, was not formally acknowledged in the structural model. It follows that the desired statistical significance was not obtained for the structural equation of the *involves others and elicits participation* competency dimension on *analyses and understands the external and internal work unit environment* competency dimension possibly because of the graduate leader performance model's failure in not formally acknowledging the (accumulating) direct and indirect feedback effects of this (mediating) latent outcome variable. The successful enactment of the competency dimension of *involves others and elicits participation* accordingly does not guarantee usable *environmental analytics* to bolster competence in the *analyses and understands the external and internal work unit environment* competency dimension, but simply serves as one possible conduit for it. However, the output delivered on the beta matrix also indicated that the *involves others and elicits participation* competency dimension tended to negatively influence the *manages the internal work unit environment* competency dimension (effect size = -.037) even if statistically insignificant so, which further complicated matters. One possible reason for this result is that the operationalisation of the *involves others and elicits participation* subscale was not successful in the sense that it tended to accentuate the idea that it denotes behaviours giving others 'free reign' in the unit, instead of the type of behaviours aimed at simply giving followers more freedom to bring the 'authentic best' out in people. Nonetheless, these findings again suggested that the mechanism explaining how leaders develop unit competitiveness could have benefited from a more comprehensive literature review when it was grafted into the graduate leader performance structural model.

The third theme that emerged from the statistical analyses concerned the link between constructive group dynamics and the reduced need for hands-on management. It was argued in Chapter 2 that by successfully developing unit competitiveness, uniting and connecting followers, involving and eliciting participation, and strengthening and enabling followers, the leader could secure human and physical resources, entrench an effective structure, and activate a number of positive psychological states in followers, which in turn, would simplify the daily task of managing the unit's operations – i.e. a leader's task in managing day-to-day operations would be simplified when working with a capable, fully-staffed team that is all 'pulling in the same direction'. In this regard, it was suggested that the effect of the competency dimension of *involves others and elicits participation*, for example, on the competency of *manages the internal work unit environment* is likely to be mediated by the psychological ownership outcome variable,<sup>377</sup> and that it would become easier for leaders to be competent on the competency of *manages the internal work unit environment* because competence on the competency of *involves others and elicits participation* strengthens collective psychological ownership in teams/units. Other outcome variables identified in Chapter 2 (also currently unacknowledged in the graduate leader competency domain structural model) such as unit cohesion, shared mental models, functional information flow, interpersonal trust, back-up behaviours, talent, collective efficacy, metacognition, effective strategy, structural fit, and resource security that were posited to come into existence because a leader is competent in the competencies of *unites and connects followers*, *involves others and elicits participation*, *strengthens and enables followers* and *develops unit competitiveness* was argued to operate in exactly the same way. It was therefore perplexing to observe that only two out of the

---

<sup>377</sup> Note that competency and outcome variables were explicated at the same time. However, only the competency variables were utilised for the purposes of the current study.



four competency dimensions that were hypothesised to buttress leadership performance in the *manages the internal work unit environment* competency functioned as per their theoretical basis. In this regard, only the *unites and connects followers* (effect size = .217) and *develops unit competitiveness* (effect size = 0.406) competency dimensions delivered statistically significant results of a relatively moderate magnitude on the *manages the internal work unit environment* competency dimension. In hindsight though, the fact that the outcome variables of *involves others and elicits participation, unites and connects followers, strengthens and enables followers, and develops unit competitiveness* was not formally acknowledged in the structural model, was perhaps exactly the reason why the relationships of these competency dimensions on the competency dimension of *manages the internal work unit environment* failed to surface (and with more pronounced effect sizes). A very large number of mediating latent outcome variables, providing feedback to specific latent competencies, or even possibly, specific latent competency potential variables, were therefore (not yet) in play here. This suggested that, if and when, the graduate leader outcome domain structural model representing these mediating variables is validated and fitted onto the graduate leader competency domain model that these (theoretically indirect) feedback relationships might more clearly come to the fore.

The final noteworthy theme that emerged from the statistical analysis concerns the link between a leader's vision and the culture that they ultimately come to entrench in the unit. The *entrenches a high-performance culture* competency dimension was structurally explained by two other competency dimensions feeding into it, namely the *displays personal leader proficiency* (effect size = .269) and *creates an exciting and aspirational vision for the unit* competency dimensions (effect size = .658). The amount of variance that the structural model accounted for in explaining the *entrenches a high-performance culture* competency dimension was a rather gratifying 79%. While the corroborated pathway from the *displays personal leader proficiency* competency dimension on the *entrenches a high-performance culture* competency dimension has already been covered earlier, it was evident from the statistical analysis that leadership effectiveness in the attraction and rallying of followers towards an inspiring and exciting vision for the unit also reinforces leadership effectiveness in the competency dimension of *entrenches a high-performance culture in the unit*. This finding was thus also a cause for reassurance as it confirmed the transformational theory of leadership's view (Bass, 1995) that vision serves as a tool for the dissemination and/or maintenance of organisational culture (Bass & Avolio, 1993; Golden, 2009; Nelson & Donnellan, 2009) that sets the tone and direction (Hatch, 1993) for its consequent distillation into the 'way things are done' in the unit.

## 6.5 OVERARCHING CONCLUSION ON THE CONSTRUCT VALIDITY OF THE PGLCQ

The overarching substantive hypothesis (i.e. Hypothesis 1) claimed that the PGLCQ provides a reliable and construct valid measure of the graduate leader performance construct (interpreted behaviourally). The overarching substantive hypothesis was in turn dissected into two narrower substantive research hypotheses in Chapter 3:

- Hypothesis 1a: The measurement model reflecting the constitutive definition of the graduate leader performance construct (interpreted behaviourally) and the design intent of the PGLCQ provides a valid account of the psychological mechanism that regulates test-takers responses to the item parcels of the PGLCQ; and
- Hypothesis 1b: The structural model implied by the connotative meaning of the graduate leader performance construct (interpreted behaviourally) as expressed by the internal structure assigned to the construct taken in conjunction with the design intent of the PGLCQ provides a valid account of the psychological processes underpinning the level of performance that graduates attain on the behavioural components of the graduate leader performance construct.

The overarching substantive hypothesis subsumed a number of more in-depth operational hypotheses. More specifically operational hypotheses 1 – 5 were dissected from the first

narrow substantive hypothesis and operational hypotheses 6 – 8 were derived from the second narrow substantive hypothesis:

- Operational hypothesis 1: The measurement model implied by the scoring key and the design intent of the PGLCQ, when a domain-representative parcelling scheme is used to group items into two parcels per latent competency, closely reproduces the covariances observed between the PGLCQ item parcels;
- Operational hypothesis 2: The factor loadings of the item parcels on their designated (second-order) graduate leader competencies respectively are statistically significant ( $p < .05$ ) and large ( $\lambda_{ij} \geq .71$ );
- Operational hypothesis 3: The graduate leader (second-order) competencies duly explain large proportions (i.e.  $> .50$ ) of the variance in the item parcels that represent them respectively;
- Operational hypothesis 4: The measurement error variances associated with each item parcel are statistically significant ( $p < .05$ ) yet small ( $\theta_{\delta_{ii}} < .50$ );
- Operational hypothesis 5: The latent graduate leader competencies (as measured by item parcels) correlate statistically significantly ( $p < .05$ ) while low to moderately with each other ( $\phi_{pk} < .90$ ), providing evidence of discriminant validity;
- Operational hypothesis 6: The competency domain structural model implied by the manner in which the constitutive definition of the graduate leader behavioural performance construct embeds (second order) competencies in a nomological network of latent variables as described in Chapter 2 can closely reproduce the covariances observed between item parcels calculated from the items comprising each of the PGLCQ scales; and
- Operational hypothesis 7: The slope of the regression of  $\eta_j$  on  $\xi_i$  and the regression of  $\eta_j$  on  $\eta_i$  in the structural model implied by the manner in which the constitutive definition of the graduate leader behavioural performance construct embeds competencies in a nomological network of latent variables are statistically significant ( $p < .05$ ). Operational hypothesis 7 thus implies the testing of 18 path-specific substantive hypotheses

Hypothesis 1a and operational hypotheses 1 – 5 were unequivocally supported by the data. The position that the observed covariances between randomly created PGLCQ item parcels can be explained in terms of nine correlated latent variables is a permissible and plausible one. This finding is compatible with the position that the construct-references derived from the PGLCQ dimensions scores are valid but is not definitive proof of the construct validity of the PGLCQ. If the PGLCQ provides construct valid measures of the graduate leader performance construct, the PGLCQ measurement model (operationalised with item parcels) should fit closely, the factor loadings of item parcels on their designated latent graduate leader competencies should be statistically significant ( $p < .05$ ) and large, the measurement error variances associated with the item parcels should be statistically significant ( $p < .05$ ) and small and the correlations between the latent graduate leader competencies should not be excessively large. When these hypotheses fail to be rejected by the data, the construct validity of the PGLCQ has not been unequivocally demonstrated. The position that the PGLCQ provides construct valid measures of the latent graduate leader competencies has survived an opportunity to be falsified.

The graduate leader performance construct carries a specific connotative meaning. The overarching hypothesis (i.e. Hypothesis 1) claims that inferences may permissibly be made about graduate leaders' standing on this construct. The connotative meaning lies in the internal structure of the construct (i.e. the manner in which the latent dimensions of the construct are thought to affect each other) and the manner in which the construct is believed to be embedded in a larger nomological network of other latent variables falling outside the conceptual domain that comprises the construct. Construct validation is a process of accumulating and cementing empirical evidence and logical thought in a credible argument in defence of the inferences made from the observed scores. Support for hypothesis 1a and operational hypotheses 1 – 5 means one

can legitimately claim that the items of the PGLCQ, grouped into parcels, reflect in a reasonably uncontaminated manner, nine latent variables. Support for hypothesis 1a and operational hypotheses 1 – 5, however, provide little ground to support the claim that the nine latent variables are in fact the specific latent graduate leader competencies conceptualised in Chapter 2 to carry specific connotative meaning (see Table 6.1). To more convincingly claim that the latent variables that the item parcels reflect are in fact the nine latent graduate leader competencies carrying the connotative meaning attributed to them (see Table 6.1), the structural model reflecting the internal structure of the graduate leader construct needs to fit the data and the hypothesised causal paths need to be shown to be statistically significant ( $p < .05$ ).

The current study partially corroborated hypothesis 1b in that it found support for operational hypothesis 6 and partial support for operational hypothesis 7. Construct validation of the PGLCQ is not a once-off procedure that arrives at a definite, binary (construct valid – not construct valid) verdict. Rather, construct validation of the PGLCQ is a never-ending process of refining and deepening the understanding of the connotative meaning (as *inter alia* expressed in the internal structure of the construct) of the graduate leader performance construct about which construct-referenced inferences may permissibly be derived from the dimension scores obtained on the PGLCQ (Cronbach & Meehl, 1955).

The current study would contend that it led sufficient research evidence to allow it to conclude that the PGLCQ reliably and validly measures a graduate leader performance construct that agrees with the manner in which the connotative meaning of the construct was explicated in Table 6.1 but that differs somewhat with the manner in which the connotative meaning of the construct that the PGLCQ intended to measure as was originally explicated in Figure 3.1. If the original position on the internal structure of the graduate leader performance construct would be modified by deleting the statistically insignificant paths ( $p > .05$ ) (in red) in Figure 6.3, the current study would contend that the connotative meaning of the graduate leader performance construct is given by the constitutive definitions of the latent graduate leader competencies shown in Table 6.1 and by the internal structural relations shown in Figure 6.4.

## 6.6 MANAGERIAL IMPLICATIONS

This study was motivated by the argument that the enhancement of superior graduate leader performance is of utmost importance in South Africa given the impending 5/50 crisis and that industries in the country are struggling to effectively compete for economic gain on the world stage. The importance of identifying and grooming future leaders because of their potential contributions as catalysts for superior organisational performance was highlighted with regard to this. The identification and delivery of practical interventions for the enhancement of graduate leader performance, however, is a challenging task in that the level of performance that graduate leaders achieve is not a random event but rather systematically determined by a complex nomological network of malleable and non-malleable person-centred and situational latent variables characterising the (graduate) leader individual and their environment. Purposeful and rational leadership acceleration interventions can thus only succeed if they target the numerous latent variables in this net deliberately and holistically via the appropriate interventions, which in turn, is only possible by understanding what these latent variables are, their nature, and the causal, structural relations that exist between them.

To develop and empirically test such a comprehensive explanatory model that explicates the identity of the pertinent person-centred and situational latent variables that characterise the individual graduate leader and their environment firstly requires a detailed conceptualisation of the graduate leader performance construct (conceptualised in terms of structurally interrelated latent behavioural competencies and latent outcomes); secondly, the availability of an instrument to measure the graduate leader performance construct; and thirdly, psychometric evidence that the instrument provides reliable, construct valid and unbiased measures of the construct as

conceptualised. The current study represents the first step in such a multistudy research project.<sup>378</sup>

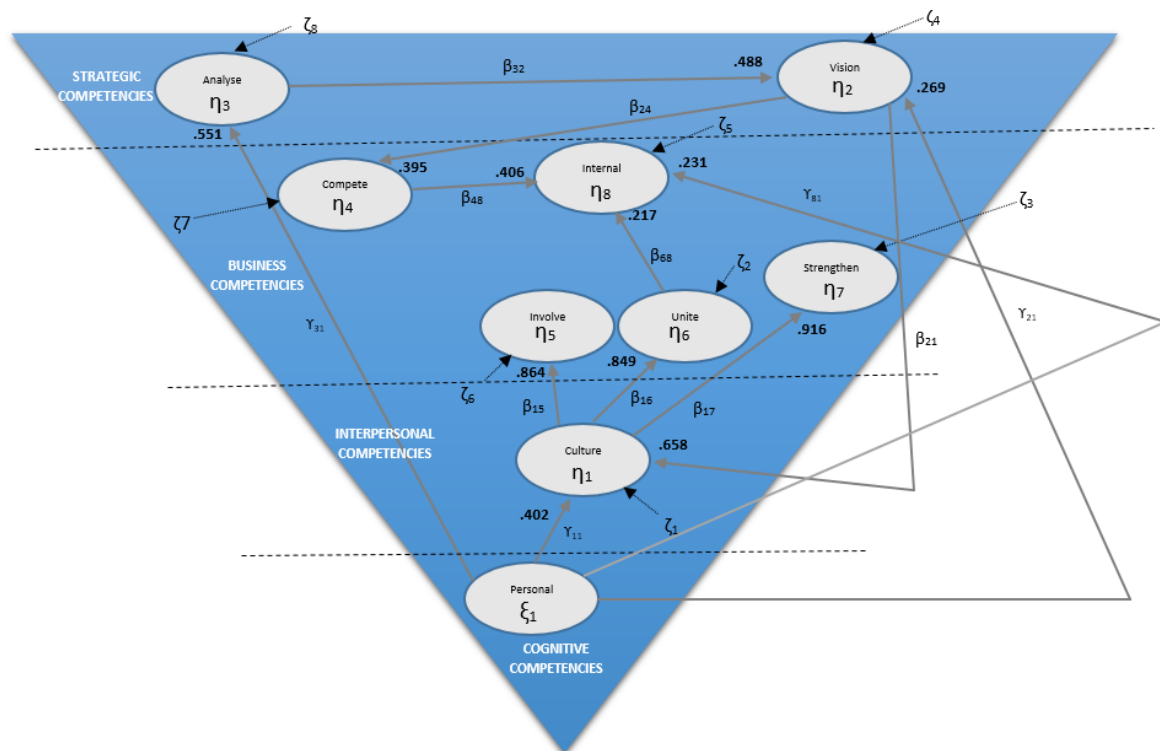

**Figure 6.4.** The internal structure of the graduate leader performance construct as measured by the PGLCQ

Note: Personal refers to *displays personal leader proficiency*, Culture refers to *entrenches a high-performance culture in the unit*, Involve refers to *involves others and elicits participation*, Unite refers to *unites and connects followers*, Strengthen refers to *strengthens and enables followers*, Internal refers to *manages the internal work unit environment*, Compete refers to *develops unit competitiveness*, Analyse refers to *analyses and understands the external and internal work unit environment*, and Vision refers to *creates an exciting and aspirational vision for the unit*.

The fact that the current study did not focus on the latent graduate leader competency potential variables or on the latent situational variables that affect graduate leader performance limits to some degree the managerial recommendations that can legitimately be derived from the current study. Leadership development has typically focused on improving the level of competence that leaders achieve on leadership competencies by providing them with explanations as to why high (or low) performance on each competency is important in terms of the outcomes that are positively (or negatively) affected, by providing feedback on their level of competence on leadership competencies and providing a variety of exercises (i.e. interventions) designed to enhance competence on those competencies flagged as development areas. It is the current study's conviction that leadership interventions seldom formally diagnose the causes of problematic performance on those specific leadership competencies flagged for attention. Typically, therefore, these exercises/interventions do not formally and explicitly focus on the latent person-centred and/or latent situational characteristics that have been diagnosed to be responsible for the problematic performance on specific competencies. Rather, the focus on the development of an appreciation of the behavioural denotations that characterise a leader's competence on specific competencies *vis-à-vis* the behavioural denotations that should ideally

<sup>378</sup> In the second phase the Graduate Leader Performance Questionnaire needs to be developed, comprising the PGLCQ (in a slightly revised/expanded form) and the Graduate Leader Outcome Questionnaire (GLOQ), and validated. This should include the revision of the internal structure currently attributed to the graduate leader performance competency construct, the explication of the internal structure of the graduate leader performance outcome construct and the explication of the integrated graduate leader performance competency-outcome construct.

characterise a leader's standing on those latent competencies and an appreciation of the manner in which these development areas cascade hold (undesirable) consequences for the level of competence achieved on other competencies and the standards achieved on specific latent outcome variables. The explanatory structural model as developed and presented in this study on the internal structure of the graduate leader (competency) performance construct furthers such understanding<sup>379</sup> and thus provides impetus for theorising on the practical steps that could be taken in order to enhance the levels of competence on the second-order latent competencies that constitute graduate leader performance (behaviourally interpreted).

In reflecting on this and how HR departments can directly or indirectly stimulate graduate leader performance (or behaviour), it was useful to first split the continuum of possible interventions into stock and flow interventions (Boudreau et al., 2008). Flow interventions target the improvement of employee performance by regulating the flow of employees into, through and out of the organisation (by typically, but not exclusively, focusing on non-malleable employee characteristics that determine employee performance), while stock interventions target performance improvement by altering the (malleable) characteristics of current employees that determine their performance. As the current study's focus was on the explication of the (malleable) second-order graduate leader competencies that constitute graduate leader performance and not on the explication of the competency potential variables standing in support of (or articulating with) this, nor the outcomes associated (or articulating) with it, its application in terms of flow interventions is limited.<sup>380</sup> Flow interventions can, however, also be based on the assessment of the competencies that constitute success outside the job (or development programme) that the selection targets. Under a content-orientated approach to selection (Binning & Barrett, 1989), the competencies that constitute success on the job are assessed outside the job via simulation (e.g. a behavioural event interview, an assessment centre, an in-basket exercise or even gaming) or in an alternative job for which the competencies are also relevant. However, the explication of the (malleable) second-order latent graduate leader competencies will probably more aggressively find stock interventions that attempt to manipulate the criterion construct (graduate leader performance) itself on the job.

### **6.6.1 THE DEVELOPMENT OF A LEADERSHIP TRAINING CURRICULUM**

The development of a training programme for the enhancement of graduate leader performance thus naturally presented itself as stock intervention that HR departments can utilise for altering trainees' standings on the (malleable) second-order graduate leader competencies towards this end. The fact that the identities of the nine second-order graduate leader competencies were explicated as a result of a comprehensive theoretical review on leadership performance, the consequent meticulous grouping of the explicated first-order competencies into internally consistent (yet mutually exclusive) behavioural themes, and the fact that these second-order themes were vetted by a number of subject matter experts from industry, means that these competency dimensions matter, and that they should be used as the basis for the development and delivery of leadership acceleration programmes around the country. Therefore, the researcher humbly offers this study's research base as a point of departure. Industrial psychologists and training and development practitioners can of course supplement this work

---

<sup>379</sup> This line of reasoning clearly attests to the importance of expanding the current partial structural model that exclusively focuses on the latent graduate leader competencies by grafting the latent outcome variables onto the current (or a revised version of it) that reflects how the latent outcome variables are affected by the level of competence achieved on the latent graduate leader competencies, and in turn, how the standard achieved on the outcomes feeds directly back onto specific competencies.

<sup>380</sup> Flow interventions typically utilise psychological assessments as measured operational definitions to measure the direct and/or indirect determinants of the to-be-effected latent criterion variable (like graduate leader performance), inputs this into a clinical or mechanical prediction model, and derives estimates from this on the latent criterion variable on which to base flow decisions. Selection is one example of a flow intervention. Binning and Barrett (1989) make a distinction between construct-orientated and content-orientated approaches to selection. The results of the current study can be used to inform a content-orientated approach to selection.

with overlapping training and development material that have already been developed for use in their organisations, as long as the identities of the second-order competencies in terms of their substantive definitions are not distorted or diluted in the process. A challenge, however, remains to deliver this leadership development experience in ways that resonate with the unique learning styles and preferences of Gen Y. Design features that perhaps need to be considered for these *digital natives*<sup>381</sup> (Prensky, 2001) who may be somewhat isolated physically (Black, 2010) and in need of constant feedback (Francis-Smith, 2004) and real-world experience (Garger, 1999), are online material and activities, the use of digital social networks, multimedia platforms (Prensky, 2001), realistic contexts (Sheahan, 2005), simulated environments, non-linear texts (Sharma & Mills, 2005) group activities and options for customisation or flexibility (Black, 2010).

However, it might not be beneficial to design leadership acceleration interventions as complete *plug and play* experiences, as the explanatory structural model presented in the study suggests that a specific sequence is applicable to leadership development. More specifically, the graduate leader performance structural model put forward a developmental path from the bottom of the model moving upwards, starting with the development of *personal leader proficiency* and *entrenches a high-performance culture in the unit* and ending with the *manages the internal work unit environment* unit towards the top, with feedback loops operating from there towards *analyses and understands the external and internal work unit environment* and *develops unit competitiveness*. As the competency dimensions at the bottom of the model essentially represent the basis of leadership performance (behaviourally interpreted) in terms of their direct and indirect effects on all of the other competency dimensions lying deeper in the model, it seems fruitless to focus training efforts on the competencies further down the line when leaders-in-training have not mastered the more foundational competencies first. For example, it would seem counterproductive for a leadership acceleration programme to start off with interventions aimed at improving the *manages the internal work unit environment* competency dimension, as the leader-in-training will have a better chance of becoming competent on this competency, if the intricate chain of cause-and-effect relationships building up from the bottom of the model between the *displays personal leader proficiency*, *entrenches a high-performance culture*, *unites and connects others*, and the *develops unit competitiveness* competency dimensions are allowed to become entrenched in their behavioural patterns and the consequences<sup>382</sup> of these patterns to functionally come into existence, by training the graduate leader-in-training to be competent on these 'up-stream' competencies first.

The critical point to grasp here is that the development of graduate leader performance (behaviourally interpreted) is complexly determined. Part of the understanding of the psychological mechanism that regulates the competence that leaders achieve on the latent competencies that constitute leadership performance lies in the manner in which these latent competencies affect each other. The structural model as developed and presented in this study

---

<sup>381</sup> Prensky (2001, p. 1) coins the term *digital natives* based on the following reflection: "Today's students – through college – represent the first generations to grow up with this new technology. They have spent their entire lives surrounded by and using computers, videogames, digital music players, video cams, cell phones, and all the other toys and tools of the digital age. Today's average college grads have spent less than 5,000 hours of their lives reading, but over 10,000 hours playing video games (not to mention 20,000 hours watching TV). Computer games, email, the Internet, cell phones and instant messaging are integral parts of their lives. It is now clear that as a result of this ubiquitous environment and the sheer volume of their interaction with it, today's students think and process information fundamentally differently from their predecessors. These differences go far further and deeper than most educators suspect or realize. "Different kinds of experiences lead to different brain structures, says Dr. Bruce D. Perry of Baylor College of Medicine. As we shall see in the next instalment, it is very likely that our students' brains have physically changed –and are different from ours – as a result of how they grew up. But whether or not this is literally true, we can say with certainty that their thinking patterns have changed. I will get to how they have changed in a minute. What should we call these 'new' students of today? Some refer to them as the N-[for Net]-gen or D-[for digital]-gen. But the most useful designation I have found for them is Digital Natives. Our students today are all 'native speakers' of the digital language of computers, video games and the Internet."

<sup>382</sup> Here the researcher is referring to the various outcomes that were hypothesised to result from being competent on the second-order graduate leader competencies.

that explicates the manner in which the latent graduate leader competencies are interrelated therefore should be used to inform the sequence with which attempts are made to target the development of the nine second-order graduate leader competencies. As some of the hypothesised pathways between some of the second-order competency dimensions were not corroborated by the data the researcher cannot be too descriptive in this regard, but it is suggested that leadership acceleration interventions at least target the mastery of the *displays personal leader proficiency* and *entrenches a high-performance culture in the unit* competency dimensions, and in this order, as a point of departure. The sheer number of direct and indirect effects they have on the other second-order competencies lying ‘deeper’ in the explanatory structural model at least suggest that not only the most short-term gains in leadership development can be achieved by following such an approach, but it also implies that leaders-in-training will likely find it more difficult to become competent in the competencies further down the line if their behaviour is not grounded in the ‘base’ competencies of *displays personal leader proficiency* and *entrenches a high-performance culture in the unit*.

### 6.6.2 JOB (ASSIGNMENT)-ROTATIONS AND LEADERSHIP DEVELOPMENT

Traditional, lecture-based classroom training as alluded to above is often only partially effective (McCall, Lombardo, & Morrison, 1988). In general, the effectiveness of the transfer of classroom training has in fact been widely criticised, because either transfer is ineffective or the transfer that does occur, is lost over time (Broad & Newstrom, 1992; Foxon, 1993; Kupritz, 2002). One reason for this phenomenon is that classroom training tends to foster “episodic or event-based thinking about development (i.e. it occurs only during a special programme)” (Day, 2007, p. 14), which is not ideal for long-term competency acquisition, nor leadership development in general (Fulmer, 1997). Moreover, in an extensive review of studies investigating the success of transfer of learning, Detterman and Sternberg (1993, p. 15) argue as follows:

Most studies fail to find transfer... (T)hose studies claiming transfer can only be said to have found transfer by the most generous criteria and would not meet the classical definition of transfer... In short, from studies that claim to show transfer and don’t show transfer, there is no evidence to contradict Thorndike’s general conclusions: Transfer is rare, and its likelihood of occurrence is directly related to the similarity between situations.

The fact that classroom training fails to appropriately simulate or replicate the work environment in which the competencies targeted by training interventions are to be transferred to, thus constitute a further explanation for why this method of training delivery, when used in isolation, is rarely successful. In other words, the more similar the task (in the training context), the greater the possibility that transfer will occur (Detterman & Sternberg, 1993) (to the work context). The “simple, compelling, but troubling explanation for shortcomings of executive development as presently constituted is that skills (i.e. competencies) learned in seminars, case discussions, classrooms and laboratories are rarely applied in the contexts in which they would be most useful” (Narayandas & Moldoveanu, 2019b, p. 8). For this reason, many authors endorse the practice of competency acquisition by way of *experience* or *learning-on-the-job* instead. Indeed, “most if not all major theories dealing with learning and psychological processes explicitly or implicitly place experience at the centre of the learning process” (Amit, Popper, Gal, & Mamane-Levy, 2008, p. 303) as well. This notion of *learning by doing* is also important in the context of leadership development specifically, because as a developmental journey it does not take place as a discrete event, but rather as a significant part of ongoing work-related experience (Day, 2007) over time. In addition, an experience-based approach is particularly suitable and in fact comes as the most highly recommended method for leadership development, because “classroom learning tends to focus on the acquisition of technical lessons...(while) varied and novel experiences outside the classroom can challenge current thinking and break up unproductive patterns of beliefs and behaviours” (Van Velsor, McCauly, & Ruderman, 2010, p. 84) more effectively. The effectiveness of leadership development in this regard is thus thought to be

enhanced as development through job experiences teaches trainees to learn their way out of problems that could not be predicted (Dixon, 1993) or that cannot be accurately simulated in a classroom setting. As opposed to classroom settings in which trainees are relatively protected from the realities of the work environment, the very nature of the challenges associated with learning-while-doing-the-job (i.e. high-stakes, complexity and pressure) promote more effective learning and trigger heightened self-reflection (Moxley, cited in Moxley & Van Velsor, 1998) as well. "Simply put, people do not develop the capacity for leadership without being in the throes of the challenge of leadership work. Participating in leadership roles and processes is often the very source of the challenge needed for leadership development... Leadership is in and of itself, learning by doing" (Van Velsor & McCauley, 2003, p. 9-10).

It follows that a carefully managed and integrated system comprising of succession and job rotations to and between a series of predefined (and/or crafted) jobs (or assignments) that draws from the study's explanatory structural model can enhance formal classroom leadership training by operating as a natural stock intervention for the development of the nine second-order graduate leader competencies, provided that the job (or assignment) content is representative of the desired training/development content, and the trainee is given scope (and allowing for their inexperience) in this position or on this assignment to grapple with the real-world problems that the typical incumbent in the job or person performing the assignment is routinely exposed to.<sup>383</sup> Google's internal leadership training programme is a prime example of this as it recognises and tackles the applicable competency development challenge head-on by tailoring in-house programmes to participants' specific circumstances, i.e. where they are in their leadership development journey (Naryandas & Moldoveanu, 2019b). In this way, learning-on-the-job co-locates competency acquisition and competency application – making the successful transfer of the applicable competency more likely (Narayandas & Moldoveanu, 2019b). Such a system needs to be carefully planned and managed though, as some types of jobs lend themselves more to development than others, and different kinds of developmental assignments are also associated with different kinds of learning (McCauley & Brutus, 1998).

This tasks HR departments with the responsibility of matching leaders-in-training with the appropriate job or assignment (content) according to their standings on the nine explicated second-order graduate leader competencies or to redesign current jobs in ways that will optimise their learning towards this end.<sup>384</sup> For example, it would seem counter-productive to keep a graduate trainee who is attempting to master the *manages the internal work unit* competency dimension on in a *contributor* (or entry) role in the organisation, as the behavioural patterns required from and the real-world problems experienced in the entry role will not optimise learning in terms of how to manage the unit's value chain. Conversely, if a trainee's focus is on the development of this same competency dimension, the demands placed on and the

---

<sup>383</sup> The reference to *succession* could lead the reader to interpret this as a flow intervention leading to the permanent promotion of graduate trainees. However, the researcher interprets this as a stock intervention in that the job or assignment content in itself is utilised to alter the trainee's (malleable) standing on the nine second-order graduate leader competencies. The trainee does not have to be formally promoted to achieve this aim. Actual decisions on succession will have to be made in conjunction with the proper, validated selection methodologies.

<sup>384</sup> Insofar as graduate trainees are incrementally 'promoted' and their experience broadened by way of a number of challenging assignments during their leadership training, the matter of remuneration will naturally become a subject of discussion. This is a bit of contentious issue in the context of leadership development but enhancement of the nine second-order graduate leader competencies can nonetheless be optimised if the company's compensation system can be merged with the 'succession' and job rotation system as discussed above. The fact is that the withholding of hygiene factors (Herzberg, 1966) such as pay increases that are not motivational (in the long term) in themselves, can still lead to dissatisfaction and serve as a discouraging factor in the developmental behaviour of employees. Even though Equity Theory (Adams, 1965) holds that training, development and promotions can serve as substitutes for pay; this suggests that HR departments will have to think carefully about the implications of succession, promotion or job rotation (assignment) decisions in terms of their graduate trainees' perceived input-to-output (equity) ratios. This is especially true for Gen Y who in general appear to have a sense of entitlement and the expectation of good pay and benefits (Ng et al., 2010).



behavioural requirements of a project manager role for example, would likely enhance competency acquisition instead. A framework for the implementation of such a system, depicting the suggested matching of job/assignment content with a leader-in-training's standing on the nine explicated second-order graduate leader competencies for enhancing the transfer of learning as superimposed on the leadership pipeline approaches of Charan et al. (2012) and Ulrich et al. (2008), are presented and offered for experimental use in industry in Table 6.4 below.

Table 6.4

*Matching competency acquisition with succession planning and job rotations: Industry application*

LEADER TRANSITION	FOCUS AND PRIMARY TASKS	SECOND-ORDER GRADUATE LEADER COMPETENCIES	DEVELOPMENTAL CONTENT	SUCCESSION AND ROTATIONS (JOBS)	ROTATIONS (SPECIAL PROJECTS AND ASSIGNMENTS)
1. MANAGING SELF	IMPACT THROUGH EXPERTISE: Job proficiency: 1. Punctuality 2. Effectiveness 3. Quality 4. Fitting in	1. Displays personal leader proficiency	1. Trust (in trainee)	Entry-level position level  1. Creditors clerk 2. Junior Accountant 3. Sales representative 4. IT programmer 5. HR consultant 6. Marketing coordinator 7. Supply chain coordinator 8. Articles clerk	1. Stretching assignments 2. Chair high-profile meetings 3. High-profile project lead 4. Coordinator for new hires 5. PA to a functional head.
2. MANAGING OTHERS	IMPACT THROUGH RELATIONSHIPS: Providing advice, guidance and assistance: 1. Assign and plan work 2. Motivate others 3. Remove obstacles 4. Feedback on performance	1. Entrenches a high-performance culture  2. Strengthening and enabling followers  3. Uniting and connecting followers  4. Involving others and eliciting participation	1. Team efficacy 2. Team psychological ownership 3. Team cohesion 4. Psychological health (team) 1. Developing talent 2. Team metacognition 3. Self-actualisation (team)  1. Shared mental models 2. Self-actualisation (member) 3. Vertical communication flow 4. Trust (between members) 1. Psychological ownership 2. Bottom-up information flow 3. Self-actualisation (team)	Managerial position level  1. Front-line customer service manager 2. Scrum master 3. Team leader 4. Regional Manager 5. Wellness coordinator 6. Functional Business Analyst lead 7. Benefits manager 8. Performance consultant/partner	1. OD interventions 2. Tough team assignment 3. Tough manager assignment 4. Attend recruitment fairs 1. Coach 2. Mentor 3. Functional instructor 4. Quality circles 1. Mediator/Arbitrator 2. Special project lead 3. Team building 4. Conflict resolution 1. Employee representative 2. Manage CEO suggestion box 3. Bright Ideas Campaign 4. Customer Service Awards

Table 6.4

*Matching competency acquisition with succession planning and job rotations: Industry application (continued)*

LEADER TRANSITION	FOCUS AND PRIMARY TASKS	SECOND-ORDER GRADUATE LEADER COMPETENCIES	DEVELOPMENTAL CONTENT	JOB	ROTATIONS (SPECIAL PROJECTS OR ASSIGNMENTS)
3. MANAGING MANAGERS	IMPACT THROUGH PROCESSES AND STRUCTURE: Leading a team: 1. Push the functional envelope 2. Measure performance 3. Blend functional with unit strategy	1. Develops unit competitiveness  2. Manages the internal work unit environment  3. Analyses and understands the external and internal work unit environment	1. Function fit 2. Function strategy 3. Function resources 4. Function talent 1. Function analytics 2. Function fit  1. Function analytics	Functional Head level  1. 2IC Talent Manager 2. 2IC Compliance Manager 3. Country Sales Manager 4. Country HR Manager 5. Depot Manager 6. Terminal Manager	1. TQM lead 2. Process re-engineering lead 3. Benchmarking 4. Function goal-setting 1. Scorecard exercise lead 2. Special task team lead 3. Cross-function secondment 4. Functional audit 1. Speak at industry conventions 2. Industry association member 3. R&D Secondment 4. Non-executive board member
4. BUSINESS MANAGER	IMPACT THROUGH VISION/STRATEGY Leading a group/enterprise 1. Evaluating strategy 2. Capital allocation 3. Capital deployment 4. Portfolio strategy 5. Core capabilities 6. Vision 7. Managing external constituencies 8. Environmental sensitivity	1. Creates an exciting and aspirational vision for the unit  2. Develops unit competitiveness  3. Analyses and understands the external and internal work unit environment  4. Involving others and elicits participation	1. Unit efficacy 2. Psychological ownership 3. Unit cohesion  1. Unit strategy 2. Resource availability 3. Talent 4. Structural fit 1. Environmental analytics  1. Entrepreneurial behaviour 2. Bottom-up information flow 3. Developing first-line leaders	Business Head Level  1. Deputy COO 2. Deputy CFO 3. Deputy Head of HR 4. Deputy CEO 5. Deputy Head of IT 6. Deputy Country Head	1. Value roll-out exercise 2. Mergers/Acquisitions 3. International secondment 4. Working with an executive coach 1. Rolling out of a new EVP 2. Business turnaround 3. Recruit senior managers 4. New business stream lead 1. Industry Association chair 2. Government liaison 3. Research arm chair 4. Executive board member 1. Climate survey roll-out 2. Restructuring exercise 3. Induction for new employees 4. Contact sessions with staff

Finally, it must be said that what we know about the work preferences of Gen Y suggest that the adoption of such a system will be well received by this specific cohort of employees. For example, the fact that this generation generally has an appetite for pressure (Shih & Allen, 2007), that they perceive challenging assignments more meaningful than life-long employment (Baruch, 2004), and that experiential learning pedagogy appears to work well with Gen Y (Allen, 2004), lends support to the notion that a developmental approach targeting the acquisition of leadership competencies through a series of stretching learning-on-the-job experiences would likely work well with Gen Y. Similarly, the fact that Gen Y has an expectation that they will change jobs frequently (Morton, 2002) with concomitant pay rises (Erikson et al., 2009) into positions or assignments that will improve their CVs (Hira, 2007) and portfolios of marketable skills (Connor & Shaw, 2008), suggest that a leadership development programme that targets incremental 'promotions' or various job rotations at times when trainees turn transitions, should appeal to them as well.

### 6.6.3 FORMATIVE FEEDBACK AND LEADERSHIP DEVELOPMENT

A third recommended stock intervention flowing from the discussion above concerns the provision of formative feedback to graduate trainees as part of an overarching performance review process in supporting them on their leadership journey. In failing to explicate the graduate leader performance construct in its entirety, the developed competency domain structural model and the PGLCQ unfortunately have less utility in this area than would be otherwise possible. For example, the availability of a fully validated competency model of the graduate leader performance construct in its entirety could be applied in industry for more meaningful, in-depth assessments of and formative feedback on the performance of graduate leaders-in-training as the associated *behaviour-outcome performance connections* would be known. A more complete set of structural models incorporating the competency potential and situational variables that impact on graduate leader performance as well as the interrelations between these and the variables included in the competency and outcome domain structural models of graduate leader performance would be have been ideal. As it stands, however, the diagnosis of non-performance and the generation of formative feedback from the perspective of a competency domain model alone is limited to drawing from and gaining insights only on effective leader behaviour. Nonetheless, the explanatory structural model as developed and presented in this study still has significant utility for the evaluation of and the provision of formative feedback on leadership development from a behavioural point of view.

Accordingly, a facilitator or coach could provide much more context to a discussion in the case where a graduate trainee is struggling to master the *unites and connects followers* competency dimension for example. In such a case, the diagnosis of performance problems can be guided by the structural model explicating the internal structure of the graduate leader performance construct and the study's research base, not only from the perspective of a failure to master the content (e.g. team-building) of that specific second-order competency domain, but also through insights the facilitator or coach has on the trainee's standing on the other second-order competencies feeding into it (i.e. *entrenches a high-performance culture* or *displays personal leader proficiency*) as well. In this way, feedback content shifts from mere advice on and techniques for acquiring or mastering the skills or knowledge (i.e. team-building) associated with the focal competency dimension under investigation (*unites and connects followers*), to a deeper awareness of possible behavioural flaws embedded 'up-stream' in the model, such as the way the graduate treats others (*entrenches a high-performance culture in the unit*) or how he or she is perceived by others (*displays personal leader proficiency*), that might be contributing factors to the problem too. Thus, the diagnosis of non-performance from the perspective of the actual mechanics of the team-building exercise becomes supplemented by a different line of diagnostic reasoning entirely that is rooted in research and that can provide more holistic solutions.

In addition, the structural model explicating the internal structure of the graduate leader performance construct can also enrich formative feedback on another level, as the future

behavioural requirements (*manages the internal work unit environment*) that mastery of the current competency dimension (*unites and connects followers*) is building towards, are now known. This allows the coach or facilitator to shape the trainee's learning towards this eventual 'down-stream' behavioural learning outcome (*manages the internal work unit environment*) in terms of specific actions, such as framing team-building activities around the improvement of *member content domains of the team or developing trust*,<sup>385</sup> which would otherwise perhaps not even feature in feedback sessions without this context being available.

A cautionary note is necessary at this point, however, as the preoccupation with the development of competencies that constitute performance in leadership development interventions typically leads to a situation where the competency potential variables that determine trainees' competence on the competencies that constitute high-performance leadership, are disregarded entirely. This is a dangerous approach as it could be seen to promote 'indoctrination' or the conditioning of trainees to (in a sense) operate in a way that is self-conflicting. For example, if a trainee naturally has a very humble disposition and leadership development training emphasises the demonstration of networking competencies for which perhaps a more confident or even egotistical demeanour is suitable, tacitly this implies behavioural conditioning (especially if rewards and salary increases are dependent on this) in that it prompts the trainee to behave in ways that are contrary to or incompatible with who they really are. Moreover, such practices are also susceptible to moral censorship as the conditioning of behavioural patterns in this way could, in the long run at least, reasonably be expected to lead to change in a trainee's identity or character as well (i.e. shifts in values or attitudes). A number of additional and related concerns are also conceivable.<sup>386</sup> Regardless, this debate inevitably broaches the question as to the manner in which leadership development should be facilitated from a procedural perspective and has implications for the manner in which the PGLCQ (and its research base) will be used in industry. From an extreme positivist perspective, one could argue that leadership development cannot be done without a comprehensive competency model and a competent coach or instructor that accurately diagnoses problems on competencies and competency outcomes in terms of shortcomings (or an overabundance) of specific competency potential or situational variables. The phenomenological argument, on the other hand, would hold that leadership development based on a partial competency model (behaviourally interpreted) could be acceptable given a competent coach or instructor that operates from such a model and that uses it as a foundation from which to guide trainees' journeys of self-exploration in directions or towards areas designated by the model.

## 6.7 LIMITATIONS

Because of the problems experienced with the collection of data and poor response and completion rates in general, the researcher had to employ an item parcelling strategy for the fitting of both the PGLCQ competency questionnaire measurement model and the graduate leader performance comprehensive LISREL model. This had implications for the accuracy of the parameter estimates and left a certain amount of uncertainty as to whether or not the parcels concealed any problematic items. Although the item and dimensionality analyses, performed per subscale, did not unequivocally flag any problematic items, the possibility that such items might emerge when looking at the structural relations between the items and their designated latent

---

<sup>385</sup> It was argued in Chapter 2 that it would become easier for leaders to be competent on the competency of *manages the internal work unit environment* because competence on the competency of *unites and connects followers* fosters trust in and develops the shared mental models of teams. Although the outcome variables of *shared mental models* and *trust* have not been formally modelled and their mediating effects not tested in the explication of the graduate leader performance (behaviourally interpreted) explanatory model, these nonetheless represent some rational, practical routes through which success in terms of the mastery of this competency dimension can be explored.

<sup>386</sup> For example, in Chapter 2 a high priority was placed on ethical leadership. Training interventions that implicitly condition leaders-in-training how to effectively reconcile a situation where they have to behave in ways that they do not inherently agree with, will likely not achieve this aim.

graduate leader competencies when evaluating the PGLCQ design intention holistically, cannot be ruled out. The researcher therefore firstly suggests that the integrity of the findings be more critically evaluated in future by fitting the models again with a larger sample. In addition to this and when a larger sample is obtained, the researcher suggests that the models be fitted again by utilising individual items as indicator variables instead of parcels. This is because in the final analysis the question should be whether the PGLCQ provides a construct valid measure of graduate leader performance (behaviourally interpreted), and this can only be satisfactorily answered when the latent competency dimensions are represented by the individual items of each subscale of the PGLCQ.

A second and related limitation of this study concerns the (lack of) methodology employed when developing the items for the different subscales of the PGLCQ. In Chapter 2 it was argued that good scale construction involves an “iterative process involving several periods of item writing, followed in each case by conceptual and psychometric analysis” (Clark & Watson, 1995, p. 311). Due to resource constraints, the researcher could unfortunately not conduct a pre-test on the PGLCQ and the psychometric integrity of the questionnaire was empirically evaluated (for the first time) in conjunction with the evaluation of the measurement and structural models. The fact that the PGLCQ subscales demonstrated acceptable levels of reliability and validity given this approach was fortunate, precluded the possibility of refining them, and is acknowledged to be a methodological shortcoming of this study. Moreover, the current study only utilised classical measurement theory when conducting item analysis on the PGLCQ’s subscales and did not heed the topical approach of item response theory (IRT). Ultimately, the use of IRT would have resulted in increased precision in terms of being able to discriminate between the respondents’ standing on the latent competency dimensions of the PGLCQ because it would have allowed the modelling of the response of each respondent of a given standing (or ability) on the latent competency dimensions to each item in the respective subscales of the PGLCQ, while the current approach was constrained by the assumption that all items were simply replications of each other or essentially merely parallel instruments (Van Alphen, Halfens, Hasman, & Imbos, 1994).

Furthermore, the fact that multi-rater data could not be collected on the PGLCQ brought the problem of common method variance (CMV) into play. In other words, because the level of competence displayed on the nine second-order graduate leader competencies was estimated using only the personal (self) ratings from graduates themselves, the possibility arose that they may have rated themselves in a too positive a manner<sup>387</sup> and that correlational relationships found in the data could therefore have been obtained due to these inflated ratings, and not the fact that different competency variable dimensions may have actually been empirically related to each other.<sup>388</sup> Checkbox, which was the survey tool used to distribute the PGLCQ questionnaires, was furthermore also programmed in such a way as to make participants respond to all items in one sitting,<sup>389</sup> which increased the probability of CMV (Burton-Jones, 2009). Given this danger, it might have been prudent to explore statistical remedies such as the use of a marker variable to control for common method biases (Lindell & Brandt, 2000; Lindell & Whitney, 2001). However, from the literature it seems that the success of this type of statistical remedy is also reliant on larger sample sizes within the context of SEM<sup>390</sup> (e.g. the PLS marker variable approach of Rönkkö and Ylitalo, (2011)) and that it does not necessarily control for one of the main causes of CMV, namely the tendency of self-raters to respond in a socially desirable manner.

---

<sup>387</sup> Although the anonymity of participants was guaranteed, the PGLCQ still did resemble a type of a performance review.

<sup>388</sup> This problem was unfortunately also exacerbated by the fact that a number of other-rater responses were added to the self-rater responses, yet were grouped under the same banner of method variance.

<sup>389</sup> Whenever a participant closed the questionnaire, all data was lost and the participant had to start again from the beginning.

<sup>390</sup> For example, Rönkkö and Ylitalo (2011) suggest that for data with severe CMV, marker variables should constitute at least 20% of the sample size.

Finally, a number of other-rater responses were combined with the self-rater responses. In the analysis of the data the nature of the rater as a source of systematic variance was, however not formally taken into account because of the sample size being too small. This is acknowledged as a further limitation.

## 6.8 RECOMMENDATIONS FOR FUTURE RESEARCH

It was mentioned in Chapter 2 that graduates have various roles to fulfil when they first enter the organisation. The first role was referred to as the *contributor role* according to which graduates contribute directly to the organisation's bottom line as part of entry-level job and participate in the larger system as followers only. A (partial) competency model for informing HR interventions as to what constitutes performance in this specific graduate role is still lacking. Secondly, while the verification of the current study's competency domain model did aim to provide some degree of insight into graduate performance for the secondary role (i.e. the *graduate programme role*), the link between the contributor and graduate programme roles was conceptualised in terms of a third competency model that can be sandwiched in between these and that articulates with them as part of a larger sequentially linked/longitudinal competency model explaining how graduates develop and mature as part of the overall leadership development journey. Such a model and broader understanding of this phenomenon is also still lacking.

Thirdly, the study provided impetus to a number of related studies that also target the eventual development of a full or comprehensive competency model for graduate leaders. The immediate priority should be: 1) the development of a graduate (leader) outcome domain structural model (and the GLOQ); and 2) the manner in which such a model would articulate 'in-sequence' with the graduate (leader) competency domain model in achieving a broader understanding of the graduate leader performance construct in its entirety. As the absence of various outcome variables possibly acting as mediator variables in the graduate performance nomological network was cited as some of the reasons for why six of the path-specific hypotheses of the competency domain structural model were not (more clearly) corroborated, the development of a graduate leader outcome domain model that articulates with it would therefore also serve to test these claims. A further spin-off of this would be; 3) the development of a competency potential domain model for graduate leaders in developing an understanding of the graduate leader *potential* construct. Therefore, it is argued that collectively an 'in-sequence' competency domain and outcomes domain model would connote graduate leader performance, while the combined 'in-sequence' competency potential and competency domain model would collectively delineate graduate leader 'potential'. The latter would provide theoretical performance input that would contribute specifically to development and performance measurement, while the former would provide theoretical input on leadership potential that is necessary for the improvement of construct-orientated selection procedures in the identification of graduate talent. A further noteworthy aim would be to explicate the contextual and situational variables that impact on graduate leader performance and map how these articulate with an 'in-sequence' graduate leader potential and/or performance construct. Such an understanding would make it possible to shift the focus from *capacity* (i.e. competency) to *capability* (i.e. freedom, tangible opportunities, enabling conditions), which is particularly important given the pressing need for affirmative action leader appointments in the country. Eventually, and if all of these aforementioned models are added together and are proven to empirically articulate with each other (or even only specific components thereof); 4) this in turn, opens up possibilities for the development of number of measurement instruments, training interventions and formative feedback tools that will cover the entire graduate leader performance space.

Fourthly, the researcher strongly suggests that future research utilise the other-rater version of the PGLCQ to collect and analyse multi-rater data on the graduate leader performance construct. The successful fitting of the PGLCQ measurement and comprehensive LISREL models utilising multi-rater data would thus put to rest some reservations regarding the common method

variance that might have impacted on the current study.<sup>391</sup> 5) Fifthly, given the global nature of the 5/50 crisis and the graduate employability dilemma, the generalisation of the graduate leader performance construct to graduates in other countries would also be a worthy pursuit. Thus, the researcher suggests that the results of this study be cross-validated by way of one or more international samples. 6) Sixthly, it was said earlier that the *develops unit competitiveness* competency dimension could probably have benefited from a more comprehensive literature review at the time when it was grafted into the graduate leader structural model. This was evidenced by the fact that it was one of the competency dimension variables for which the least amount of variance was accounted for by the structural model (i.e. 58%) and also that it was the competency dimension for which most of the paths running into it were not corroborated by the data. Future research should therefore be mindful of this as well as the possible reasons for why this occurred as discussed under section 6.4. More specifically, the study's results provide impetus for building on this component of the graduate leader performance structural model by providing guidance as to the nature of the latent situational variables (i.e. relating to environmental unpredictability) that are suggested to be investigated for this purpose.

At some point the Graduate Leader Performance Battery [GLPB] comprising the PGLCQ and the GLOQ, should be evaluated for race and gender measurement bias as well. Such studies should examine construct bias, weak measurement invariance, strong measurement invariance, strict measurement invariance, metric equivalence, and scalar equivalence and equivalence (Spangenberg, Theron, & Dunbar, 2011). Multigroup confirmatory factor analysis provides an appropriate statistical technique to evaluate the measurement invariance and equivalence of the GLPB. Moreover it is recommended that once a comprehensive graduate leader competency model (i.e. a model that covers the competency potential, the situation, the competency, and the outcome domains) has been proposed, and empirical evaluation studies have resulted in reasonable support for the model, that the structural invariance of the model across racial and gender groups should also be investigated. Multigroup structural equation modelling offers an appropriate statistical technique (Theron & Spangenberg, 2016) for this purpose.

Finally, the modification indicates as per the LISREL output in Chapter 5 included a number of suggestions for how the graduate leader performance structural model could be improved (in terms of fit). The addition of pathways from the *analyses and understands the external and internal work unit environment* competency dimension on the *involves others and elicits participation* competency dimension and from the *involves others and elicits participation* competency dimension on the *unites and connects followers* competency dimensions was suggested and the researcher conceded that such relationships were not incompatible with the theoretical base underlying the graduate leader performance construct. Hence, future research in this area could improve the integrity of the graduate leader structural model by building a case around the addition of these pathways through an authentic, honest explication effort questing for the truth.

## 6.9 CONCLUSION

South African industry appears to be struggling to compete effectively on the world stage as is evidenced by the World Economic Forum's Global Competitiveness Report (2019) that ranks the country at sixty out of one-hundred-and-forty-one countries. As more than a 40 percent of the world's countries are currently outperforming South Africa in terms of economic performance, our society needs to generate viable and sustainable solutions to address this competitiveness gap. The availability and effective functioning of leaders in industry represents one solution towards achieving or working towards superior organisational competitiveness and performance. In this regard, leaders can serve as catalysts for superior organisational performance by driving much needed transformation (Yukl, 2009) and superior strategic choice

---

<sup>391</sup> The evidence also suggested that the *involves others and elicits participation* subscale tended to accentuate behaviours giving followers *free reign* in the unit. Future research in this area might therefore want to consider refining the item set of this particular subscale.



(Child, 1972), positively impacting follower motivation and performance (Bass, 1985), achieving synergistic gains within groups and teams (Hackman & Wageman, 2005), leveraging vision and culture (Bass & Avolio, 1993) to inspire others and affect emotional contagion (Hatfield, Cacioppo, & Rapson, 1994), and exerting influence over others to structure the activities and relationships in groups, teams or units towards success (Khaleelee & Woolf, 1996).

The present study was an attempt to contribute to the quest for the identification, development and retention of the country's leadership talent through the development of a research base and instrument that can inform a number of HR interventions towards this end. The fact that the identities of the nine second-order graduate leader competencies were explicated as a result of a comprehensive theoretical review on leadership performance, the consequent meticulous grouping of the explicated first-order competencies into internally consistent (yet mutually exclusive) behavioural themes, and the fact that these second-order themes were vetted by a number of subject matter experts from industry, means that these competency dimensions matter, and that they should be used as the basis for the development and delivery of leadership acceleration programmes around the country.

It might, however, not be beneficial to design leadership acceleration interventions as complete *plug and play* experiences such as is the case with many of the programmes offered by training consultancies in the market today (Naryandas & Moldoveneanu, 2019b), as the explanatory structural model as validated in the study suggests that a specific sequence is applicable to leadership development. More specifically, the graduate leader performance structural model put forward a developmental path from the bottom of the model moving upwards, starting with the development of *personal leader proficiency* and *entrenches a high-performance culture in the unit* and ending with the *manages the internal work unit environment* unit towards the top, with feedback loops operating from there towards *analyses and understands the external and internal work unit environment* and *develops unit competitiveness*.

This 'developmental path' is of particular importance to mentors and coaches who take future leaders under their wing. Coaches and mentors can use this framework to move their feedback and development discussions away from mere advice on and techniques for acquiring or mastering the skills or knowledge associated with a specific competency, to a deeper awareness of possible behavioural flaws 'up-stream' that might be contributing to a particular competency acquisition problem. It is also important to consider this developmental path when reflecting on leadership development experiences that can maximise transfer of learning. Accordingly, it would seem pointless to keep a leader-in-training in an entry level job (or assignment) who have already mastered the 'up-stream' competencies, and who require daily exposure and hardships on a strategic level in order to master the 'down-stream' environmental scanning (*analyses and understands the internal and external work unit environment*) competency for example.

This tasks HR departments with the responsibility of designing a carefully managed and integrated leadership training and development system that couples formal training sessions with a number of succession and job rotations to and between a series of predefined (and/or crafted) jobs (or assignments) in facilitating the acquisition of these (second-order) leadership competencies. These systems will improve the *status quo* by taking into consideration the specific level of development of each leader-in-training and can tailor each trainee's leadership developmental path according to their personal needs. As a 'natural' stock intervention, such a system of 'learning-on-the-job' can powerfully co-locate leadership competency acquisition and competency application – making the transfer of learning more likely. Ultimately, this study advances the quest for the availability and effective functioning of leaders in South African organisations via the practical suggestions offered for improving and accelerating leadership development as well as suggestions for future research to build on this, thus making a significant contribution to the development of a leading best practice approach to the recruitment, selection and development of high-performance graduate leaders for South Africa's future.

## REFERENCES

- Adams, J.S. (1965). Inequality in social exchange. *Advanced Experimental Psychology*, 62, 335–343.
- Ajzen, I. (2001). Nature and Operation of Attitudes. *Annual Review of Psychology*, 52, 27-58.
- Ajzen, I., & Fishbein, M. (1980). *Understanding Attitudes and Predicting Social Behaviour*. Englewood Cliffs, NJ: Prentice Hall.
- Albertyn, R.M (2001): Increased accountability through empowerment assessments. *People Dynamics*, 19(2), 20.
- Allen, N.J., & Meyer, P. (1990). The measurement and antecedents of affective, continuance, and normative commitment to the organisation. *Journal of Occupational Psychology*, 63, 1-18.
- Allen, P. (2004). Welcoming Y. *Benefits Canada*, 28, 51-53.
- Almaney, A. (1974). Communication and the systems theory of organization. *Journal of Business Communication*, 12(35), 35-43.
- Altschuld, J.W. (2003). *Delphi technique. Lecture, applied evaluation design*. Ohio: Ohio State University.
- Alya, A.O., Aned, A.O., & Zainal, S.R.M. (2013). Talent Management. *Journal of Management and Sustainability*, 3(4), 110-113.
- Amagoh, F. (2008). Perspectives on Organisational Change: Systems and Complexity Theories. *Public Sector Innovation Journal*, 13(3), 1-14.
- Amos, T., Ristow, A., Ristow, L., & Pearse, N.J. (2008) *Human Resource Management* (3<sup>rd</sup> ed.). Cape Town: Juta.
- Amason, A.C. (1996). Distinguishing the effects of functional and dysfunctional conflict on strategic decision-making: Resolving a paradox for top management teams. *Academy of Management Journal*, 39, 123-148.
- Amason, A.C., & Sapienza, H. (1997). The effects of top management team size and interaction norms on cognitive and affective conflict. *Journal of Management*, 23, 495-516.
- Ambrose, M.L., & Cropanzano, R.S. (2000). The effect of organizational structure on perceptions of procedural fairness. *Journal of Applied Psychology*, 85, 294–304.
- Amir, Y. (1976). The role of intergroup contact in change of prejudice and race relations. In P.A. Katz (Ed.). *Towards the elimination of racism* (pp. 245-308). New York, NY: Pergamon.
- Amit, K., Popper, M., Gal, R., & Mamane-Levy, T. (2008). Leadership-shaping experiences: a comparative study of leaders and non-leaders. *Leadership & Organisational Development Journal*, 30(4), p. 302-318.
- Anastos, D., Bedos, A., & Seaman, B. (1980). The development of modern management practices in Saudi Arabia. *Columbia Journal of World Business*, 15(2), 81-91.

- Ancona, D.G., & Caldwell, D.F. (1992). Bridging the boundary: External activity and performance in organisational teams. *Administrative Science Quarterly*, 37, 634-665.
- Andersen, P.O., Jensen, M.K., Lippert, A., & Ostergaard, D. (2010). Identifying nontechnical skills and barriers for improvement of teamwork in cardiac arrest teams. *Resuscitation*, 81(6), 695-702.
- Anderson, J.C., & Gerbing, D.W. (1988). Structural equation modelling in practice: a review and recommended two-step approach. *Psychological Bulletin*, 103(3), 411-423.
- Aoyagi, M.W., Cox, R.H., & McGuire, R.T. (2008). Organisational citizenship behaviour in sport: Relationships with leadership, team cohesion, and athlete satisfaction. *Journal of Applied Sport Psychology*, 20, 25-41.
- Apostolou, A. (2002). *Dissemination of innovation and Knowledge Management Techniques*. Retrieved March 22, 2018 from [http://www.urenio.org/tools/en/employee\\_involvement.pdf](http://www.urenio.org/tools/en/employee_involvement.pdf).
- Archer, W., & Davison, J. (2008). *Graduate employability: The views of employers*. UK: Council for Industry and Higher Education.
- Argote, L., & McGrath, J.E. (1993). Group processes in organisations. Continuity and change. In C. L. Cooper & I.T. Robertson (Eds.), *International review of industrial and organisational psychology* (pp. 333-389). New York, NY: John Wiley & Sons.
- Argyris, C. (1980). Some Limitations of the Case Method: Experiences in a Management Development Program. *Academy of Management Review*, 5(2), 291-298.
- Argyris, C., & Schön, D.A. (1996). *Organisational Learning II: Theory, Method and Practice*. Reading, MA: Addison-Wesley.
- Armstrong, M. (2010). *A Handbook of Human Resource Management Practice*. London: Kogan Page.
- Arneson, R.J. (1982). The principle of fairness and free-rider problems. *Ethics*, 92(4), 616-633.
- Arvey, R.D., & Murphy, K.R. (1998). Performance evaluation in work settings. *Annual Review of Psychology*, 49, 141-168.
- Aryee, S., & Chen, Z.X. (2006). Leader-member exchange in a Chinese context: Antecedents, the mediating role of psychological empowerment and outcomes. *Journal of Business Research*, 59, 793-801.
- Åström, K.J., & Murray, R.M. (2008). *Feedback Systems: An Introduction for Scientists and Engineers*. UK: Princeton University Press.
- Athey, T.R., & Orth, M.S. (1999). Emerging competency methods for the future. *Human Resource Management*, 38, 215-226.
- Avolio, B.J., Bass, B.M., Jung, D.I., & Berson, Y. (2003). Predicting unit performance by assessing transformational and transactional leadership. *Journal of Applied Psychology*, 88, p. 207-218.

- Avolio, B.J., Zhu, W., Kho, W., & Bhatia, P. (2004). Transformational leadership and organisational commitment: Mediating role of psychological empowerment and moderating role of structural distance. *Journal of Organisational Behaviour*, 25, 951-968.
- Avolio, T., & Gardner, W.L. (2005). Authentic leadership development: Getting to the root of positive forms of leadership. *The Leadership Quarterly*, 16, 315-338.
- Ayoko, O.B., Callan, V.J., & Härtel, C.E. (2008). The influence of team emotional intelligence climate on conflict and team members' reactions to conflict. *Small Group Research*, 39(2), 121-149.
- Babakus, E., Ferguson, C.E., & Jöreskog, K.G. (1987). The sensitivity of confirmatory maximum likelihood factor analysis to violations of measurement scale and distributional assumptions. *Journal of Marketing Research*, 24, 2228.
- Babbie, E. (2016). *The Practice of Social Research*. Boston, MA: Cengage Learning.
- Babbie, E., & Mouton, J. (2001). *The Practice of Social Research*. Cape Town: Oxford University Press.
- Bachmann, R., & Zaheer, S. (2006). *Handbook of trust research*. Northampton, MA: Edward Elgar Publishing.
- Bagozzi, R.P., & Yi, Y. (1990). Assessing method variance in multitrait- multimethod matrices: The case of self-reported affect and perceptions at work. *Journal of Applied Psychology*, 75, 547-560.
- Bagozzi, R.P., Yi, Y., & Phillips, L.W. (1991). Assessing construct validity in organizational research. *Administrative Science Quarterly*, 36, 421-458.
- Bailey, R., Bartram, D., & Kurz, R. (2001). *Cracking competencies: Development of the SHL competency framework*. [Paper presentation]. BPS Centenary Conference, Scotland.
- Bakker, A.B., & Demerouti, E. (2007). The Job Demands-Resources model: state of the art. *Journal of Managerial Psychology*, 22(3), 309-328.
- Bakker, A.B., & Demerouti, E. (2014). Job Demands-Resources Theory. In P.Y. Chen & C.L. Cooper (Eds.), *Work and Wellbeing: A Complete Reference Guide* (pp. 1-2). New York, NY: John Wiley & Sons.
- Bakker, A.B., Demerouti, E., & Verbeke, W. (2004). Using the Job Demands-Resources model to predict burnout and performance. *Human Resource Management*, 43(1), 83-104.
- Bakker, A.B., Schaufeli, W.B., Leiter, M.P., & Taris, T.W. (2008). Work engagement: An emerging concept in occupational health psychology. *Work & Stress*, 22(3), 187-200.
- Bales, R.F. (1950). A set of categories for the analysis of small group interaction. *American Sociological Review*, 15, 257-263.
- Bandalos, D.L., & Finney, S.J. (2001). Item parcelling issues in structural equation modeling. In G.A. Marcoulides & R.E. Schumacker (Eds.), *Advanced structural equation modelling: New developments and techniques* (pp. 269-296). Mahwah, NJ: Lawrence Erlbaum Associates.
- Bandalos, D.L. (2008). Is parcelling necessary? A comparison of results from item parcelling and categorical variable methodology. *Structural Equation Modeling*, 15, 211-240.

- Bandura, A. (1977). *Social learning theory*. Englewood Cliffs, N.J: Prentice-Hall.
- Bandura, A. (1982). Self-efficacy mechanism in human agency. *American Psychologist*, 37, 122-147.
- Bandura, A. (1986). *Social foundations of thought and action: A social cognitive theory*. Englewood Cliffs, NJ: Prentice-Hall.
- Bandura, A. (1997). *Self-efficacy: The exercise of control*. New York, NY: W.H. Freeman and Company.
- Banfield, P., & Kay, R. (2008). *Introduction to Human Resource Management*. Oxford: Oxford University Press.
- Barlow, L. (2006). Talent development: the new imperative? *Development and learning in Organisations: an International Journal*, 20(3), 6-9.
- Barnard, R., Cosgrove, D., & Welsh, J. (1998). *Chips & pop: Decoding the nexus generation*. Toronto: Malcolm Lester.
- Barnes, J., Cote, J., Cudeck, R., & Malthouse, E. (2001). Factor-analysis – checking assumptions of normality before conducting factor analysis. *Journal of Consumer Psychology*, 10(1/2), 79-81.
- Barney, J.B. (1986). Strategic factor markets: Expectations, luck and business strategy. *Management Science*, 32, 1231-1241.
- Barrett, G.V., & Depinet, L. (1991). A Reconsideration of Testing for Competency Rather Than for Intelligence. *American Psychologist*, 46(10), 1012-1024.
- Barrett, P. (2007). Structural equation modelling: Adjudging model fit. *Personality and Individual Differences*, 42, 815-824.
- Barrett, R. (2006). *Building a Values-Driven Organisation: A Whole System Approach to Cultural Transformation*. Boston, MA: Butterworth-Heinemann.
- Barrow, S., & Mosley, R. (2005). *The Employer Brand: Bringing the Best of Brand Management to People at Work*. Chichester: John Wiley & Sons.
- Barsade, G.S., & Gibson, D.E. (2007). Why does affect matter in organisations? *Academy of Management Perspectives*, 21(1), 36-59.
- Bartram, D. (2005). The Great Eight Competencies: A criterion-centric approach to validation. *Journal of Applied Psychology*, 90(6), 1185-2103.
- Bartram, D. (2001). *Predicting competency dimensions from components: A validation of the two-step process*. Thames Ditton, UK: SHL Group.
- Bartram, D. (2004). Assessment in organisations. *Applied Psychology: An International Review*, 53, 237-259.
- Baruch, Y. (2004). *Managing careers: Theory and Practice*. Harlow: Prentice-Hall.
- Bass, B.M. (1985). *Leadership and performance beyond expectations*. New York, NY: The Free Press.

- Bass, B.M. (1990). From transactional to transformational leadership: Learning to share the vision. *Organizational Dynamics*, 18(3), 19-31.
- Bass, B.M. (1995). Theory of transformational leadership redux. *Leadership Quarterly*, 6, 463-478.
- Bass, B.M., & Avolio, B.J. (1993). Transformational leadership and organisational culture. *Public Administration Quarterly*, 17, 112-121.
- Bass, B.M., & Bass, R. (2008). *The Bass Handbook of Leadership: Theory, Research, and Managerial Applications*. New York, NY: The Free Press.
- Bate, S. (1994). *Strategies for Cultural Change*. Oxford: Butterworth Heinemann.
- Bauer, H.H. (1992). *Scientific Literacy and the Myth of the Scientific Method*. Urbana, IL: University of Illinois Press.
- Baumeister, R.F., & Leary, M.R. (1995). The need to belong: Desire for interpersonal attachments as a fundamental human motivation. *Psychological Bulletin*, 117, 497-529.
- Baumgartner, H., & Homburg C. (1996). Applications of structural equation modelling in marketing and consumer research: a review. *International Journal of Research in Marketing*, 13, 139-161.
- Beauchamp T.L., & Childress, J.F. (1979). *Principles of Biomedical Ethics*. New York, NY: Oxford University Press.
- Beauchamp, T.L., & Childress, J.F. (2009). *Principles of Biomedical Ethics*. New York, NY: Oxford University Press.
- Beauducel A., & Herzberg, P.Y. (2006). On the performance of maximum likelihood versus means and variance adjusted weighted least squares estimation in CFA. *Structural Equation Modelling*, 3, 186-203.
- Beddingfield, C. (2005). Transforming the ROI of your graduate scheme. *Industrial and Commercial Training*, 37(4), 199-203.
- Beechler, S., & Woodward, I.C. (2009). The global 'war for talent'. *Journal of International Management*, 15, 273-285.
- Beer, M., Spector, B., Lawrence, P., Quinn Mills, D., & Walton, R. (1984). *Managing Human Assets*. New York: The Free Press.
- Beeson, I., & Davis, C. (2000). Emergence and accomplishment in organisational change. *Journal of Organisational Change Management*, 13(2), 178-189.
- Bensghir, T.K. (2006). *Information Technology and Organisational Change*. [Paper presentation]. TODIA conference, Turkey.
- Bentler, P., Bagozzi, R.P., Cudeck, R., & Iacobucci, D. (2001). Structural equation modelling—SEM using correlation or covariance matrices. *Journal of Consumer Psychology*, 10(1/2), 85-87.
- Bentler, P.M. (1989). *EQS Structural equations program manual*. Los Angeles, CA: BMDP Statistics Software.

- Bentler, P.M. & Chou, C. (1987). Practical issues in structural modelling. *Sociological Methods and Research*, 16, 78-117.
- Bentler, P.M. (2005). *EQS 6 Structural equations program manual*. Encino, CA: Multivariate Software.
- Bentler, P.M. (2006) *EQS 6 Structural Equations Program Manual*. Encino, CA: Multivariate Software, Inc.
- Bentley, T. (1995). Organisation management. *Management Accounting*, 73(6), 38.
- Berson, Y., Shamir, B., Avolio, B.J., & Popper, M. (2001). The relationship between vision, strength, leadership style and context. *The Leadership Quarterly*, 12(1), pp. 53-73.
- Bhatnagar, J. (2008). Managing capabilities for talent engagement and pipeline development. *Industrial and Commercial Training*, 40(1), 19-28.
- Binning, J.F., & Barrett, G.V. (1989). Validity of Personnel decisions: a conceptual analysis of the inferential and evidential bases. *Journal of Applied Psychology*, 74, 478-494.
- Birt, M., Wallis, T., & Winternitz, G. (2004). Talent retention in a changing workplace: an investigation of variables considered important to South African talent. *South African Journal of Business Management*, 35(2), 25-31.
- Black, A. (2010). Gen Y: Who they are and how they learn. *Education Horizons*, 88(2), p. 92-101.
- Boal, K.B., & Bryson, J.M. (1988). Charismatic leadership: A phenomenological and structural approach. In B.R. Baliga, H.P. Dachler, J.G. Hunt, & C.A. Schriesheim (Eds.), *Emerging leadership vistas* (pp. 11-28). Lexington, MA: Lexington Books.
- Bock, G.W., Zmud, R.W., Kim, Y.G., & Lee, J.N. (2007). Behavioural intention formation in knowledge sharing: Examining roles of extrinsic motivators, social-psychological forces, and organisational climate. *Management Information Systems Quarterly*, 29(1), 87-111.
- Bollen, K.A. (1987). *Structural equations with latent variables*. New York: John Wiley & Sons.
- Bollen, K.A. (1989). Total, direct, and indirect effects in structural equation models. *Sociological Methodology*, 17, 37-69.
- Bollen, K.A. (1990). Overall fit in covariance structure models: Two types of sample size effects. *Psychological Bulletin*, 107(2), 256-259.
- Bono, J.E. & Judge, T. (2003). Self-concordance at work: toward understanding the motivational effects of transformational leadership. *Academy of Management Journal*, 46, 554-57.
- Boomer, L.G. (2012). Leadership, management and administration: What's the difference? *Accounting Today*, 26(9), 34-34.
- Boomsma, A., & Hoogland, J.J. (2001). The robustness of LISREL modelling revisited. In S. du Toit, R. Cudeck, & D. Sörbom (Eds.), *Structural equation models: Present and future* (pp. 139-169). Chicago: Scientific Software International.
- Borman, W.C., & Motowidlo, S.J. (1993). Expanding the criterion domain to include elements of contextual performance. In W.C. Borman & N. Schmitt (Eds.), *Personnel selection in organizations* (pp. 71-98). San Francisco, CA: Jossey-Bass Publishers.

- Botes, P. (2017). *The development and evaluation of a generic individual non-managerial performance measure*. (Unpublished Master's thesis). University of Stellenbosch.
- Bouckenooghe, D., Raja, U., & Butt, A.N. (2013). Combined effects of positive and negative affectivity and job satisfaction on job performance and turnover intentions. *The Journal of Psychology, 14*(2), 105-123.
- Boudreau, J.W., & Ramstad, P.M. (2005). Talentship, talent segmentation, and sustainability: A new HR decision science paradigm for a new strategy definition. *Human Resource Management, 42*, 129-136.
- Boudreau, J.W., Milkovich, C., & Milkovich, G.T. (2008). *Human Resource Management*. Homewood, IL: Irwin.
- Boulding, K.E. (1956). General systems theory – the skeleton of science. *Management Science, 2*, 197-208.
- Bourbonais, R.N., Vinet, A., Meyer, F., & Goldberg, M. (1992). Certified sick leave and workload: A case referent study among nurses. *Journal of Occupational Medicine, 34*, 69-74.
- Bourdieu, P. (1986). The forms of capital. In J.G. Richardson (Ed.), *Handbook of Theory and Research for the Sociology of Education* (pp. 241-258). New York, NY: Greenwood Press.
- Bourgeois, L.J., McAllister, D.W., & Mitchell, T.R. (1978). The effects of different organisational environments upon decisions about organisational structure. *Academy of Management Journal, 21*(3), 508-514.
- Bowerman, J. (2003). Leadership development through action learning: an executive monograph. *International Journal of Health Care Quality Assurance Incorporating Leadership in Health Services, 16*(4), 6-14.
- Boxall, P., & Purcell, J. (2008). *Strategy and Human Resource Management*. Basingstoke: Palgrave Macmillan.
- Boxall, B., & Purcel, J. (2016). *Strategy and Human Resource Management* (4<sup>th</sup> ed.). London: Palgrave Macmillan.
- Boyatzis, R.E. (1982). *The competent manager: A model for effective performance*. New York, NY: Wiley-Interscience.
- Braun, V., & Clarke, V. (2008). Using thematic analysis in psychology. *Qualitative Research in Psychology, 3*, 77-101.
- Broad, M.L. & Newstrom, J.W. (1992). *Transfer of Training*. Reading, MA: Addison Wesley.
- Brooks, K.W. (1979). Delphi technique: Expanding applications. *North Central Association Quarterly, 54*(3), 377-385.
- Brown, A. (1995). *Organisational culture*. London: Pitman Publishing.
- Brown, K.G., & Kozlowski, S.W.J. (1999). *Dispersion theory: moving beyond a dichotomous conceptualisation of emergent organisational phenomena*. [Paper presentation]. The Society of Industrial and Organisational Psychology, Atlanta.



- Brown, T.A. (2006). *Confirmatory factor analysis for applied research*. New York, NY: The Guilford Press.
- Browne, M.W. (1984). The decomposition of multitrait-multimethod matrices. *British Journal of Mathematical and Statistical Psychology*, 37(1), 1-21.
- Browne, M.W. (1987). Robustness of statistical inference in factor analysis and related models. *Biometrika*, 74, 375-384
- Browne, M.W., & Cudeck, R. (1992). Alternative ways of assessing model fit. In K. A. Bollen and J. S. Long (Eds.), *Testing structural equation models* (pp. 136-162). Newbury Park, CA: Sage.
- Brownell, J. (2006). Meeting the competency needs of global leaders: A partnership approach. *Human Resource Management*, 45(6), 309-336.
- Brunton, A. & Jeffrey, L. (2010). Using the critical incident technique for triangulation and elaboration of communication management competencies. *Journal of Vocational Education and Training*, 62(3), 239.
- Brunton-Smith, I., Carpenter, J., Kenward, M., & Tarling, R. (2012). Multiple Imputation for handling missing data in social research. *Social Research Update*, 64, 1-4.
- Bryman, A. (1992). *Charisma and Leadership in Organisations*. London: Sage.
- Burger, R. (2012). *Modifications, elaboration and empirical evaluation of the De Goede learning potential structural model*. (Unpublished Master's thesis). University of Stellenbosch, Stellenbosch, South Africa.
- Burke, R., Cary, L., & Cooper, J.J. (2006). *Human Resources Revolution: Why putting people first matters*. London: Elsevier.
- Burns, T., & Stalker, G.M. (1961). *The management of innovation*. London: Tavistock.
- Burrows, G.D., & Stanley, R.O. (2005). The role of stress in mental illness: the practice. In C.L. Cooper (Ed.), *Handbook of Stress Medicine and Health* (pp. 87-100). Oxford: Oxford University Press.
- Burton-Jones, A. (2009) Minimising method bias through programmatic research. *MIS Quarterly*, 33(3), p. 445-471.
- Byrne, B.M. (1998). *Structural equation modelling with LISREL, PRELIS, and SIMPLIS: Basic concepts, applications and programming*. Mahwah, NJ: Lawrence Erlbaum Associates.
- Byrne, B.M. (2012). *Structural Equation Modelling with MPlus: Basic Concepts, Applications, and Programming*. New York, NY: Taylor Francis Group.
- Cabellero, C.L., & Walker, A. (2010). Work readiness in graduate recruitment and selection: a review of current assessment methods. *Journal of teaching and learning for graduate employability*, 1(1), 13-25.
- Cable, D.M., & Graham, M. (2000). The determinants of organisational reputation: A job search perspective. *Journal of applied social psychology*, 33, 244-266.
- Callahan, J.L. (2010). Constructing a manuscript: Distinguishing integrative literature reviews and conceptual and theory articles. *Human Resource Development Review*, 9, 300-304.

- Cameron, K.S., & Quinn, R.E. (2006). *Diagnosing and changing organizational culture: Based on the competing values framework*. San Francisco, CA: Wiley-Jossey Bass.
- Campbell, D., & Fiske, D. (1959). Convergent and discriminant validation by the multitrait-multimethod matrix. *Psychological Bulletin*, *56*(2), 81-105.
- Campbell, D.T., & O'Connell, E. J. (1982). Methods as diluting trait relationships rather than adding irrelevant systematic variance. In D. Brinberg & L.H. Kidder (Eds.), *Forms of validity in research. New directions for methodology of social and behavioural science* (pp. 93-111). San Francisco: Jossey-Bass.
- Campbell, D.T., & O'Connell, E.J. (1967). Method factors in multitrait-multimethod matrices: Multiplicative rather than additive? *Multivariate Behavioural Research*, *2*, 409-426.
- Campbell, J.P. (1990). Modelling the performance prediction problem in industrial and organisational psychology. In M.D. Dunnette, & L.M. Hough (Eds.), *Handbook of Industrial and Organisational Psychology* (pp. 687-732). Palto Alto CA: Consulting Psychologists Press.
- Campbell, J.P., McCloy, R.A., Oppler, S.H., & Sager, C.E. (1993). A theory of performance. In W.C. Borman & N. Schmitt (Eds.), *Personnel selection in organisations* (pp. 35-70). San Francisco, CA: Jossey-Bass.
- Campion, M.A., Carr, L., Fink, A.A., Ruggerberg, Phillips, G.M., & Odman, R.B. (2011). Doing competencies well: Best practices in competency modelling. *Personnel Psychology*, *64*, 225-262.
- Canary, H. (2011). *Communication and organizational knowledge: Contemporary issues for theory and practice*. Florence, KY: Taylor & Francis.
- Cannon, M.D., & Edmondson, A.C. (2001). Confronting failure: Antecedents and consequences of shared beliefs about failure in organisational work groups. *Journal of Organisational Behaviour*, *22*, 161-177.
- Cannon-Bowers, J.A., Salas, E., & Converse, S.A. (1993). Shared mental models in expert team decision making. In N.J. Castellan Jr. (Ed.), *Current issues in individual and group decision-making* (pp. 221-246). Hillsdale, NJ: Erlbaum.
- Capaldo, G., Landolil, L, Zollo, G. (2006). A situationalist perspective to competency management. *Human Resource Management*, *45*(3), 429-448.
- Capps, C., & Hazen, E. (2002). Applying general systems theory to the strategic scanning of the environment from 2015 to 2050. *International Journal of Management*, *19*(2), 308-314.
- Carless, S.A., & De Paola, C. (2000). The measurement of cohesion in work teams. *Small Group Research*, *31*, 71-88.
- Carpini, J.A. (2017). *Individual work performance and consequences*. (Published PhD thesis). University of Western Australia, Perth, Australia.
- Carron, A.V. (1982). Cohesiveness in sport groups: Interpretations and considerations. *Journal of Sport Psychology*, *4*, 123-138.
- Carron, A.V., Spink, K., & Prapavessis, H. (1997). Team building in sport. *International Journal of Sport Psychology*, *27*, 269-285.

- Carsten, J.M., & Spector, P.E. (1987). Unemployment, job satisfaction and employee turnover: A meta-analytic test of the Muchinsky model. *Journal of Applied Psychology*, 72, 199-212.
- Carter, D.R., & Fiore, S., & Asencio, R. (2015). Conflict, trust, and cohesion: Examining affective and attitudinal factors in Science teams. *Team Cohesion: Advances in Psychological Theory, Methods and Practice Research on Managing Groups and Teams*, 17, 271-301.
- Cascio, W.F. (1998). *Applied Psychology in Human Resource Management*. Englewood Cliffs, NJ: Prentice Hall.
- Casey-Campbell, M., & Martens, M.L. (2009). Sticking it all together: A critical assessment of the group cohesion-performance literature. *International Journal of Management Reviews*, 11(2), 223-246.
- Casper, W.J., Harris, C., Taylor-Bianco, A., & Wayne, J.H. (2011). Work-family conflict, perceived supervisor support and organisational commitment among Brazilian professionals. *Journal of Vocational Behaviour*, 79, 640-652.
- CEDEFOP, S. (2010). *Supply and demand in Europe: medium-term forecast up to 2020*. Luxembourg: Publications Office of the European Union.
- Chamberlin, T.C. (1965). The method of multiple working hypotheses. *Science, New Series*, 148(3671), 754-759.
- Chan, D. (2005). Current directions in personnel selection decisions. *Current directions in psychological science*, 13(4), 220-223.
- Chan, Y.H., Taylor, R.R., & Markham, S. (2008). The role of subordinates' trust in social exchange driven psychological empowerment process. *Journal of Managerial Issues*, 20(4), 444-467.
- Chanda, A., Krishna, B.C., & Shen, J. (2007). *Strategic Human Resource Technologies: Keys to managing people*. Los Angeles, CA: Sage publications.
- Chang, A., & Bordia, P. (2001). A multidimensional approach to the group cohesion-group performance relationship. *Small Group Research*, 32, 379-405.
- Chao, G., & Moon, H. (2005). The cultural mosaic: a metatheory for understanding the complexity of culture. *Journal of Applied Psychology*, 90(6), 1128-1140.
- Chapman, S.D., Uggerslev, K.L., Carroll, S.A., Piasentin, K.A., & Jones, D.A. (2005). Applicant attraction to organisational job choice: A meta-analytic review of correlates of recruiting outcomes. *Journal of applied psychology*, 9(5), 928-944.
- Charan, R. (2008). *Leaders at all Levels*. San Francisco, CA: Jossey-Bass.
- Charan, R., Drotter, S., & Noel, J. (2012). *The Leadership Pipeline: How to Build the Leadership Powered Company*. San Francisco: Wiley and Sons.
- Checkland, P. (1997). *Systems Thinking, Systems Practice*. Chichester: John Wiley & Sons Ltd.
- Chen, C.J., & Huang, J.W. (2007). How organisational climate and structure affect knowledge management: The social interaction perspective. *International Journal of Information Management*, 27(2), 104-118.

- Chen, F., Curran, P.J., Bollen, K.A., Kirby, J., & Paxton, P. (2008). An empirical evaluation of the use of fixed cut-off points in RMSEA test statistic and structural equation models. *Sociological methods & Research*, 13(4), 462-494.
- Chen, H.C., & Naquin, S.S. (2006). An integrative model of competency development, training design, assessment center, and multi-rater assessment. *Advances in Developing Human Resources*, 8, 265-282.
- Chen, M., Sheng, C., & Tian, Y. (2010). Relationships among teamwork behaviour, trust, perceived team support, and team commitment. *Social Behaviour and Personality: An international journal*, 38, 1297-1306.
- Chikampa, V. (2013). *The development and empirical evaluation of an affirmative development coaching competency questionnaire*. (Unpublished PhD thesis). University of Stellenbosch, Stellenbosch, South Africa.
- Child, J. (1972). Organisational structure, environment and performance: The role of strategic choice, *Sociology* 6, 1-22.
- Chin, W. (1998). Commentary: Issues and opinion on structural equation modelling. *Management Information Systems Quarterly*, 22, 7-16.
- Cho, S., & Johanson, M.M. (2008). Organisational citizenship behaviour and employee performance: A moderating effect of work status in restaurant employees. *Journal of Hospitality & Tourism Research*, 32(3), 307-326.
- Choo, C.W. (2001). Environmental scanning as information seeking and organisational learning. *Information Research*, 7(1), 1-7.
- Choo, C.W. (2002). *Information management for the intelligent organisation: the art of scanning the environment* (3<sup>rd</sup> ed.). Medford: Information today.
- Christie, A., Barling, J., & Turner, N. (2007). Pseudo-transformational leadership: Towards the development and test of a model. *Journal of Business Ethics*, 81(4), 851-861.
- Christie, A., Barling, J., & Turner, N. (2011). Pseudo-transformational leadership: Model specification and outcomes. *Journal of Applied Social Psychology*, 44(12), 2943-2984.
- Cilliers, P. (1998). *Complexity and postmodernism: Understanding complex systems*. London: Routledge.
- Cilliers, J. (2020). *Africa first: Igniting a growth revolution*. Johannesburg: Jonathan Ball Publishers.
- Clarke, V., & Braun, V. (2013). Teaching thematic analysis: Overcoming challenges and developing strategies for effective learning. *Psychologist*, 26(2), 120-123
- Clark, L.A., & Watson, D. (1995). Constructing validity: Basic issues in objective scale development. *Psychological Assessment*, 3, 309-319.
- Clark, M.S., & Mills, J. (1979). Interpersonal attraction in exchange and communal relationships. *Journal of Personality and Social Psychology*, 37(1), 12-24.
- Clark, M.S., Mills, J., & Corcoran, D. (1989). Keeping track of needs and inputs of friends and strangers. *Personality and Social Psychology Bulletin*, 15, 533-542.

- Cleary, T.A. (1968). Test bias: prediction of grades of Negro and White students in integrated colleges. *Journal of Educational Measurement*, 5, 115-124.
- Clemmer, J. (2003). *The Leader's Digest: Timeless Principles for Team and Organization Success*. Canada: TCG.
- Cliff, N., & Keats, J.A. (2005). *Ordinal measurement in the behavioural sciences*. Mahwah, NJ: Lawrence Erlbaum.
- Coghlan, D. (2013). Action learning research? Reflections from the colloquium at the Third International Conference on Action Learning. *Action Learning: Research and Practice*, 10(1), 54-57.
- Cohen, J. (1988). *Statistical Power Analysis for the Behavioural Sciences*. Hillsdale, NY: Lawrence Erlbaum.
- Cohen, J. (1992). A Power Primer. *Psychological Bulletin*, 112(1), p. 155-159.
- Cohen, L., Manion, L., & Morrison, K. (2000). *Research Methods in Education*. Canada: Routledge.
- Coldwell, D.A., Billsberry, J., van Meurs, N., & Marsh, P.J.G. (2008). The effects of person-organisation ethical fit on employee attraction and retention: Towards a testable explanatory model. *Journal of Business Ethics*, 78, 611-622.
- Collings, D.G., Scullian, H., & Vaiman, V. (2011). European perspectives on talent management. *European Journal of International Management*, 5(5), 453-462.
- Collins, J.C., & Porras, J.I. (1994). *Built to Last: Successful Habits of Visionary Companies*. New York: Harper Collins.
- Colquitt, J.A., Conlon, D.E., Wesson, M.J., & Porter, C.N. (2001). Justice at the millennium: a meta-analytic review of 25 years of organisational justice research. *Journal of Applied Psychology*, 86, 425-445.
- Conger, J., & Toegel, G. (2002). Action learning and multi-rater feedback as leadership development interventions: popular but poorly deployed. *Journal of Change Management*, 3(4), 332-348.
- Conger, J.A. & Kanungo, R.N. (1987). Towards a behavioural theory of charismatic leadership in organizational settings. *Academy of Management Review*, 12, 637-647.
- Conger, J.A., & Kanungo, R.N. (1988). The empowerment process: Integrating theory and practice. *Academy of Management Review*, 13(3), p. 471-482.
- Conger, J.A., & Kanungo, R.N. (1992). Perceived behavioural attributes of charismatic leadership. *Canadian Journal of Behavioural Science*, 24, 86-102.
- Conger, J.A., Kanungo, R.N. (1998). *Charismatic Leadership in Organisations*. Thousand Oaks, CA: Sage Publications.
- Connell, J.P., Deci, E.L., & Ryan, R.M. (1989). Self-determination in a work organisation. *Journal of Applied Psychology*, 74(4), p. 580-590.
- Connor, H., & Shaw, S. (2008). Graduate training and development: current trends and issues. *Education and Training*, 50(5), 357-365.

- Cook J., & Nkomo, S. (2006). Leadership in Africa. In J. Luiz, (Ed.), *Managing business in Africa* (pp. 83-108). Cape Town: Oxford Southern Africa.
- Cooley, C.H. (1909). *Social Organization: A Study of the Larger Mind*. New York, NY: Charles Scribner's Sons.
- Cornell, C., & Nwoka, J. (2015). The systems theory of management in modern day organisations – A study of Aldgate Congress Resort Limited. *International Journal of Scientific and Research Publications*, 5(9), 2250-3153.
- Corporate Leadership Research Council (2014). *Driving Performance and Retention through Employee Engagement*. London: The Corporate Executive Board Company (UK) Ltd.
- Corruption Watch. (2016, October 20). *What's happening in the PRASA case?* Retrieved July 23, 2017 from <http://www.corruptionwatch.org.za/whats-happening-prasa-case/>.
- Costley, D., & Howell, J. (2006). *Understanding Behaviours for Effective Leadership*. Upper Saddle River, NJ: Pearson Prentice Hall.
- Cox, S., Preto, N., Woodgate, R.L., & Kolopack, P. (2009). Ethical challenges and evolving practices in research on ethics in health. *Health Law Review*, 17(2/3), 33-39.
- Cranmer, S. (2006). Enhancing graduate employability: best intentions and mixed outcomes. *Studies in Higher Education*, 31(2), 169-184.
- Creswell, J.W. (2007). *Qualitative inquiry and research design: Choosing among five approaches*. Thousand Oaks, CA: Sage publications.
- Creswell, J.W., & Creswell, J.D. (2018). *Research design: qualitative, quantitative, and mixed methods approaches*. CA: SAGE.
- Creswell, J. W., & Clark, V. L. Plano Clark (2018). *Designing and conducting mixed methods research*. Los Angeles, CA: SAGE.
- Crocker, A., & Eckardt, R. (2014). A multilevel investigation of individual- and unit-level human capital complementarities. *Journal of Management*, 40, 509–530.
- Croft, L., & Seemiller, C. (2017). Developing Leadership Competencies. *New Directions For Student Leadership*, 156, 7-18.
- Cronbach, L., & J., Gleser, G.C. (1965). *Psychological tests and personnel decisions*. Urbana, IL: University of Illinois.
- Cronbach, L.J., & Meehl, P.E. (1955). Construct validity in psychological tests. *Psychological Bulletin*, 52, 281-302.
- Cronbach, L.J., Schoneman, P., & McKie, D. (1965). Alpha Coefficients for stratified-parallel tests. *Educational & Psychological Measurement*, 25, 291-312.
- Cross, R., Ernst, C., & Pasmore, B. (2013). A bridge too far? How boundary spanning networks drive organisational change and effectiveness. *Organisational Dynamics*, 42, 81-91.
- Crumpacker, M., & Crumpacker, J.M. (2007). Succession planning and generational stereotypes: should HR consider age-based values and attitudes a relevant factor or passing fad? *Public Personnel Management*, 3(4), 349-369.

- Cudeck, R. (1988). Multiplicative models and MTMM matrices. *Journal of Educational Statistics*, 13(2), 131-147
- Cudeck, R., & Browne, M.W. (1983). Cross-validation of covariance structures. *Multivariate Behavioural Research*, 18, 147-167.
- Ćurković\*, N. (2012). Using of structural equation modelling techniques in cognitive levels validation. *Interdisciplinary Description of Complex Systems* 10(3), 270-283.
- Curran, P.J., West, S.G., & Finch, J.F. (1996). The robustness of test statistics to nonnormality and specification error in confirmatory factor analysis. *Psychological Methods*, 1(1), 16-29.
- Custer, R.L., Scarcella, J.A., & Stewart, B.R. (1999). The modified Delphi technique: A rotational modification. *Journal of Vocational and Technical Education*, 15(2), 1-10.
- Cyphert, F.R., & Gant, W.L. (1971). The Delphi technique: A case study. *Phi Delta Kappan*, 52, 272-273.
- Da Ruan, G.Z., Lu, J., & Wu, F. (2007). *Multi-objective group decision-making: Methods, software and applications with fuzzy set techniques*. London: Imperial College Press.
- Daft, R.L. (1999). *Leadership: Theory and Practice*. Orlando: Dryden.
- Daft, R.L. (2008). *Management*. USA: South-Western Cengage Learning.
- Dalkey, N.C. (1972). The Delphi method: An experimental study of group opinion. In N.C. Dalkey, D.L. Rourke, R. Lewis, & D. Snyder (Eds.), *Studies in the quality of life: Delphi and decision-making* (pp. 13-54). Lexington, MA: Lexington Books.
- Damachi, U. G. (1978). *Theories of Management and the Executive in the Developing World*. London: MacMillan.
- Davenport, T.H., Eccles, R.G., & Prusak. L. (1992). Information Politics. *Sloan Management Review*, 34(1), 53-65.
- Day, D.V. (2007). *Developing leadership talent: A guide to succession planning and leadership development*. USA: SHRM Foundation.
- De Dreu, C.K.W., & Weingart, L.R. (2003). Task versus relationship conflict, team performance, and team member satisfaction: A meta-analysis. *Journal of Applied Psychology*, 88, 741-9.
- De Goede, J. (2007). *An investigation into the learning structure of the learning potential construct as measured by the APIL test battery*. (Master's thesis). University of Stellenbosch, Stellenbosch, South Africa.
- De Jong, B.A., & Elfring, T. (2010). How does trust affect the performance of ongoing teams? The mediating role of reflexivity, monitoring, and effort. *Academy of Management Journal*, 53(3), 535-549.
- De Vos, A., & Freese, C. (2011). Sense making during organisational entry: Changes in newcomer information seeking and the relationship with psychological contract fulfilment. *Journal of Occupational and Organisational Psychology*, 84, 288-314.
- DeLamater, J.D. and Myers, D.J. (2007). *Social Psychology*. Belmont, CA: Thomson Wadsworth.

- Demerouti, E., Bakker, A.B., Nachreiner, F., & Schaufeli, W.B. (2001). The job demands-resources model of burnout. *Journal of Applied Psychology*, 86, 499-512.
- Demsetz, H. (1988). The theory of the firm revisited. *Journal of Law, Economics, and Organisation*, 4(11), 141-162.
- Department of Health. (2013). *Regulations relating to research on human subjects*. Pretoria: SA Government agencies.
- DeRenzo, E.G., & Moss, J. (2006). *Writing clinical research protocols: Ethical considerations*. Burlington, MA: Elsevier Academic.
- Desai, A.B. (2000). Does strategic planning create value? The stock market's belief. *Management Decision Journal*, 38(10), 658-693.
- Desson, K., Clouthier, J. (2010). *Organisational Culture – Why Does It Matter?* [Paper presentation]. Symposium on International Safeguards for the International Atomic Energy Agency, Austria.
- Detterman, D.K., & Sternberg, R.J. (Eds.). (1993). *Transfer on trial: Intelligence, cognition, and instruction*. Norwood, NJ: Ablex.
- Devaguptapu, V.N. (2017). Framework for integrating – employer branding & talent sourcing. *International Journal of Advanced Scientific Research & Development*, 4(1), 33-39.
- Development Policy Research Unit (2006). *Unemployment in Post-Apartheid South Africa: Nature and Possible Policy Responses*. Retrieved July 11, 2016 from <http://www/commerce.uct.ac.za/dpru/>.
- Diamantopoulos, A. & Siguaw, J.A. (2000). *Introducing LISREL*. London: Sage.
- Ding, C.G., & Lin, C. (2006). Comparing the effects of determinants of turnover intentions between Taiwanese and U.S. hospital employees. *Human Resource Development Quarterly*, 17(4), 403-421.
- Dion, K.L. (2000). Group cohesion: From 'field of forces' to multidimensional construct. *Group Dynamics: Theory, Research, and Practice*, 4(1), 7.
- DiStefano, C., Jian, N., Lui, J., & Shi, D. (2017). Examination of the Weighted Root Mean Square Residual: Evidence for Trustworthiness? *Structural Equation Modelling: A Multidisciplinary Journal*, 1-14.
- Dixon, B.M. (1993). Developing managers for the learning organisation. *Human Resource Management Review*, 3, 243-254.
- Doherty, N., Vinney, C., & Adamson, S. (1997). Rhetoric or reality: shifts in graduate career management? *Career Development International*, 2(4), 173-179.
- Dolan, C.V. (1994). Factor analysis of variables with 2, 3, 5, and 7 response categories: A comparison of categorical variable estimators using simulated data. *British journal of Mathematical and Statistical Psychology*, 47, 309-326.
- Dooley, J.J., & Kerch, H.M. (2000). Evolving research misconduct policies and their significance for physical scientists. *Science and Engineering Ethics*, 6, 109-121.



- Doughty, H.A. (2004). Employee empowerment: Democracy or delusion? *The Public Sector Innovation Journal*, 9(2), 1-26.
- Draganidis, F., & Mentzas, G. (2006). Competency based management: a review of systems and approaches. *Information Management and Computer Security*, 14(1), 51-64.
- Dries, N., & Pepermans, R. (2012). How to identify leadership potential: Development and testing of a consensus model. *Human Resource Management*, 51(3), 361-385.
- Dries N., Vantilborgh, T., & Pepermans, R. (2012). The role of learning agility and career variety in the identification and development of High Potential employees. *Personnel Review* 41 (3), 340-58.
- Driscoll, M.E., & Goldring, E.B. (2005). How can school leaders incorporate communities as contexts for student learning? In W.A. Firestone & C. Riehl (Eds.), *A New Agenda for Research in Educational Leadership* (pp. 61-80). New York, NY: Teachers College Press.
- Druskat, V.U., & Wheeler, J.V. (2003). Managing from the boundary: The effective leadership of self-managing work teams. *Academy of Management Journal*, 46, 435-457.
- Du Toit, B. (2014). *The modification, elaboration and empirical evaluation of the De Goede learning potential structural model through the incorporation of non-cognitive learning competency potential latent variables*. (Unpublished Master's thesis). Stellenbosch University, Stellenbosch, South Africa.
- Du Toit, W., & Roodt, G. (2003). The discriminant validity of the culture assessment instrument: A comparison of company cultures. *South African Journal of Human Resource Management*, 1(1), 77-84.
- Dumenci, L. (2000). Multitrait-multimethod analysis. In S.D. Brown & H.E.A. Tinsley (Eds.), *Handbook of Multivariate Statistics and Mathematical modeling* (pp. 583-611). San Diego, CA: Academic Press.
- Duncan, R.B. (1972). Characteristics of organisational environments and perceived environmental uncertainty. *Administrative Science Quarterly*, 17, 313-327.
- Durheim, K., Painter, D., & Terre Blanche (2006). *Research in Practice: Applied methods for the social sciences*. University of Cape Town Press.
- Dyce, J.A., & Cornell, J. (1996). Factorial validity of the Group Environment Questionnaire among musicians. *Journal of Social Psychology*, 136, 263-264.
- Dyczkowska, J., & Dyczkowski, T. (2015). Examining management information flows in business organisations. *International Journal of Contemporary Management*, 14(4), 45-74.
- Eagly, A.H., & Chaiken, S. (1993). *The Psychology of Attitudes*. Orlando, FL: Harcourt.
- Ebbesen, M., Anderson, S., & Pedersen, B.D. (2012). Further development of Beauchamp and Childress' theory based on empirical ethics. *Journal of Clinical Research in Bioethics*, 6(1), 1-7.
- Eckel, C.C., & Grossman, P.J. (2005). Managing diversity by creating team identity. *Journal of Economic Behaviour & Organisation*, 58, 371-392.

- Edmondson, A.C. (2003). Speaking up in the operating room: How team leaders promote learning in interdisciplinary action teams. *Journal of Management Studies*, 40, 1419-1452.
- Edmondson, A.C., Dillon, J.R., & Roloff, K.S. (2007). Three perspectives on team learning: Outcome improvement, task mastery, and group process. *The Academy of Management Annals*, 1(1), 269-314.
- Edwards, M.R. (2010). An integrative review of employer branding and CB theory. *Personnel Review*, 39(1), 5-23.
- Edwards, M.R. (2005). Organisational identification: A conceptual and operational review. *International Journal of Management Reviews*, 7(4), 207-230.
- Einhorn, H.J., & Bass, A.R. (1971). Methodological considerations relevant to discrimination in employment testing. *Psychological Bulletin*, 75, 261-269.
- Eisner, S.P. (2005). Managing generation Y. *SAM Advanced Management Journal*, 70(4), 4-15.
- Ellis, A.P., Hollenbeck, J.R., Ilgen, D.R., Porter, C.O., West, B.J., & Moon, H. (2003). Team learning: Collectively connecting the dots. *Journal of Applied Psychology*, 88 (5), 821-835.
- Elsaid, N.M., Okasha, A.E., & Abdelghaly, A.A. (2013). Defining and solving the organisational structure problems to improve the performance of Ministry of State for Environmental Affairs. *International Journal of Scientific and Research Publications*, 3(10), 1-10.
- Elsbach, K.D., & Sutton, R.I. (1992). Acquiring organizational legitimacy through illegitimate actions: A marriage of institutional and impression management theories. *Academy of Management Journal*, 35, 699-738.
- Ensley, M.D., & Pearce, C.L. (2001). Shared cognition in top management teams: Implications for new venture performance. *Journal of Organisational Behaviour*, 22(2), 145-160.
- Ehrenreich, B. (1991). Science, lies and the ultimate truth. *Time*, 137(20), 66.
- Erhart, M.G., & Naumann, S.E. (2004). Organisational citizenship behaviour in work groups: a group norms approach. *Journal of Applied Psychology*, 89(6), 960-974.
- Erikson, T., Alsop, R., Nicholson, P., & Miller, J. (2009). Gen Y in the workforce. *Harvard Business Review*, 87(2), 43-49.
- Eustace, A., & Martins, N. (2014). The role of leadership in shaping organisational climate: An example from the fast moving consumer goods industry. *South African Journal of Industrial Psychology*, 40(1), 1-14.
- Evans, C.R., & Dion, K.L. (1991). Group cohesion and performance: a meta-analysis. *Small Group Resources*, 22(2), 175-186.
- Evans, J.N., & Jarvis, P.A. (1980). Group cohesion: a review of re-evaluation. *Small Group Behaviour*, 11, 359-370.
- Eys, M.A., Loughead, T.M., & Hardy, J. (2007). Athlete leadership dispersion and satisfaction in interactive sports. *Psychology of Sport and Exercise*, 8, 281-296.
- Fairholm, G.W. (1994). *Leadership and the Culture of Trust*. Westport, CT: Praeger.

- Fairhurst, D., & Shaw, S. (2008). Engaging a new generation of graduates. *Education and Training, 50*(5), 366-378.
- Farrell, A.M. (2010). Insufficient discriminant validity: a comment on Bove, Pervan, Beatty and Shiu (2009). *International Journal of Business Research, 63*(3), 324-327.
- Farrell, A. M., & Rudd, J. M. (2009). *Factor analysis and discriminant validity: A brief review of some practical issues*. In the Australia and New Zealand Marketing Academy Conference. Melbourne, Australia.
- Fernandez-Araoz, C., Graysberg, B., & Nohria, N. (2011). How to hang on to your High Potentials. *Harvard Business Review, 81*(2), 76-83.
- Ferres, N., Connel, J., & Travaglione, A. (2004). Co-worker trust as a social catalyst for constructive employee attitudes. *Journal of Managerial Psychology, 19*, 608-22.
- Fisk, G.M., & Friesen, J.P. (2012). Perceptions of leader emotion regulation and LMX as predictors of followers' job satisfaction and organizational citizenship behaviours. *The Leadership Quarterly, 23*, 1, 1-12.
- FitzGerald, K., Seale, S., Kerins, C.A., & McElvaney, R. (2008). The critical incident technique: a useful tool for conducting qualitative research. *Journal of dental education, 3*, 299-358.
- Flanagan, J. (1954). The critical incident technique. *Psychological Bulletin, 51*(4), 327-358.
- Fleishman, E.A., & Zaccaro, S.J. (1992). Toward a taxonomy of team performance functions. In R.W. Swezey & E. Salas (Eds.), *Teams: Their training and performance* (pp. 31-56). Westport, CT: Ablex Publishing.
- Fleishman, E.A., Mumford, M.D., Zaccaro, S.J., Levin, K.Y., Korotkin, A.L., & Hein, M.B. (1991). Taxonomic efforts in the description of leader behaviour: A synthesis and functional interpretation. *Leadership Quarterly, 2*, 245-287.
- Flyvbjerg, B. (2001). *Making social science matter. Why social inquiry fails and how it can succeed again*. Cambridge: Cambridge University Press.
- Foreman, H. (2006). Understanding Gen Y employees. *Credit Union Magazine, April*, 70-71.
- Fornell, C., & Larcker, D.F. (1981). Evaluating structural equation models with unobservable variables and measurement error. *Journal of Marketing Research, 18*(1), 39-50.
- Forrest, S., & Shevlin, M. (2003). Alternative factor models of the Expagg scale: A re-evaluation using confirmatory factory analysis. *Current Research in Social Psychology, 8*, 191-131.
- Foster, E.K. (2004). Research on gossip: taxonomy, methods, and future directions. *Review of General Psychology, 8*(2), 78-99.
- Fourie, M. (2015). *The development of a South African medical practitioners competency questionnaire*. (Unpublished Master's thesis). University of Stellenbosch, Stellenbosch, South Africa.
- Foxon, M. (1993). A process approach to the transfer of training. *Australian Journal of Educational Technology, 9*(2), 130-143.

- Francis-Smith, J. (2004). *Surviving and thriving in the multigenerational workplace*. Retrieved February 22, 2018 from [http://findarticles.com/p/articles/mi\\_qn4182/is\\_20040826/ai\\_n10162498/](http://findarticles.com/p/articles/mi_qn4182/is_20040826/ai_n10162498/).
- Frank, F.D. (2004). Introduction to the special issue on employee retention and engagement. *Human Resource Planning, 27*(3), 11.
- Fraser, D.L., & Stupak, R.J. (2002). A synthesis of the strategic planning process with the principles of learning, leading and thinking. *International Journal of Public Administration, 25*(9), 1199-1220.
- French, J.R.P., Jr., & Raven, B.H. (1959). The bases of social power. In D. Cartwright (Ed.), *Studies in social power* (pp. 150-167). Ann Arbor, MI: Institute for Social Research.
- Freud, S. (1921). *Group psychology and the analysis of the ego*. London: Hogarth.
- Fry, L.W. 2003. Toward a theory of spiritual leadership. *The Leadership Quarterly, 14*, 693-727.
- Fulmer, R.M. (1997). The evolving paradigm of leadership development. *Organisational Dynamics, 25*(4), 59-72.
- Garavan, T.N., Corberry, R., & Rock, A. (2011). Mapping talent development: definition, scope and architecture. *European Journal of Training and Development, 36*(1), 5-24.
- Garazonik, R., Nethersell, G., & Spreier, S. (2006). Navigating through new leadership landscape. *Leader to Leader, 39*, 30-39.
- Garcia-Prieto, P., Bellard, E., & Schneider, S.C. (2003). Experiencing diversity, conflict, and emotions in teams. *Applied Psychology: An International Review, 52*, 413-40.
- Gardner, J.W. (1990). *On leadership*. New York, NY: The Free Press.
- Garger, E.M. (1999). Holding on to high performers: A strategic approach to retention. *Compensation and Benefits Management, 15*(4), 10-17.
- Garver, M.S., & Mentzer, J.T. (1999). Logistics research methods: employing structural equation modelling to test for construct validity. *Journal of Business Logistics, 20*(1), 33-57.
- Gatewood, R.D., Feild, H.S., & Barrick, M. (2008). *Human resource selection*. Mason, OH: Thomson.
- Gefen, D., Straub, D.W., Boudreau, M.C. (2000). Structural Equation Modelling and Regression Guidelines for Research Practice. *Communications of the Association for Information Systems, 4*(7), 2-77.
- Geib, P., & Swenson, J. (2013). China: Transformational leadership for policy and product innovation. *Advances in Management, 6*(5), 3-10.
- George, J.M., & Jones, G.R. (1998). The experience and evolution of trust: Implications for cooperation and teamwork. *Academy of Management Review, 23*: 531-46.
- Gerbing, D.W., & Anderson, J.C. (1993). Monte Carlo evaluations of goodness-of-fit indices for structural equation models. In K.A. Bollen & J.S. Long (Eds.), *Testing structural equation models* (pp. 40-65). Newbury Park, CA: Sage.

- Gibson, C.B. (1999). Do they do what they believe they can? Group efficacy and group effectiveness across tasks and cultures. *Academy of Management Journal*, 42, 138-152.
- Gilbreath, B., & Benson P.G. (2004). The contribution of supervisor behaviour to employee psychological well-being. *Work & Stress*, 18, 255-266.
- Gill, R. (2006). *Theory and Practice of Leadership*. London: Sage.
- Gilliland, M.A., & Tynan, A. (1997). Leadership and transformation in an environment of unpredictability. *Cause/Effect*, 20(3), 51-58.
- Giuffre, M. (1997). Designing Research: Ex Post Facto Design. *Journal of Paraesthesia Nursing*, 12(3), 191-195.
- Glaser, R. (1990). The re-emergence of learning theory within instructional research. *American Psychologist*, 45, 29-39.
- Goffin, R.D. (1987). *The analysis of multitrait-multimethod matrices: An empirical and Monte Carlo comparison of two procedures*. Unpublished doctoral dissertation. Canada: University of Western Ontario.
- Goffin, R.D., & Jackson, D.N. (1992). Analysis of multitrait-multirater performance appraisal data: Composite direct product method versus confirmatory factor analysis. *Multivariate Behavioural Research*, 27, 363-386.
- Gokenbach, V. (2003). Infuse management with leadership. *Nursing Management*, 34(1), 8-9.
- Golden, J. (2009). Leadership in hard times. *Sales and Service Excellence*, 9(1), 11.
- Goldstein, K. (1934). *The organism: A holistic approach to biology derived from pathological data in man*. New York, NY: Zone Books.
- Goleman, D., Boyatzis, R., & McKee, A. (2002). *Primal Leadership*. Boston, MA: Harvard Business School.
- Gorman, J.C., Cooke, N.J., & Winner, J.L. (2006). Measuring team situation awareness in decentralised command and control environments. *Ergonomics*, 49, 1312-1325.
- Graen, B. G., & Orris, J.B. (1973). Role assimilation process in a complex organisation. *Journal of Vocational Behaviour*, 3(4), 395-420.
- Graetz, B. (1993). Health consequences of employment and unemployment: Longitudinal evidence for young men and women. *Social Science & Medicine*, 36, 715-724.
- Graham J. M. (2006). Congeneric and (essentially) tau-equivalent estimates of score reliability: What they are and how to use them. *Educational and Psychological Measurement*, 66, 930-944.
- Graham, J.W., Taylor, B.J., Olchowski, A.E., & Cumsille, P.E. (2006). Planned missing data designs in psychological research. *Psychological Methods*, 11(4), 323-343.
- Grant, C., & Osanloo, A. (2014). Understanding, selecting and integrating a theoretical framework in dissertation research: Creating the blueprint for your 'house'. *Administrative Issues Journal: Connecting Education, Practice, and Research*, 4(2), 12-16.

- Greenberg, J. (1990). Employee theft as a reaction to underpayment inequity: The hidden cost of pay cuts. *Journal of Applied Psychology*, 5, 561–568.
- Greenberg, J.A., & Baron, R.A. (2008). *Behaviour in Organisations*. Upper Saddle River, NJ: Pearson Education.
- Greene, L., & Burke, G. (2007). Beyond self-actualisation. *Journal of Health and Human Services Administration* 1(1), 116-128.
- Greenleaf, R.K. (1977). *Servant leadership: A journey into the nature of legitimate power and greatness*. New York, NY: Paulist Press.
- Griffiths, M. (2000). Collaboration and partnership in question: knowledge, politics, and practice. *Journal of Educational Policy*, 15(4), 383-395.
- Grinbaum A., & Groves, C. (2013). What is responsible about responsible innovation? Understanding ethical issues. In J. Bessant, M. Heintz, & R. Owen (Eds.), *Responsible Innovation: Managing the Responsible Emergence of Science and Innovation in Society* (pp. 119-142). London: Wiley.
- Grinnell, F. (1992). *The Scientific Attitude*. New York, NY: Guilford.
- Groenewald, T. (2003). Growing talented people through cooperative education: a phenomenological exploration. *Asia-Pacific Journal of Cooperative Education*, 4, 49-61.
- Grove, W.M., & Meehl, P.E. (1996). Comparative efficiency of informal (subjective, impressionistic) and formal (mechanical, algorithmic) prediction procedures: The clinical-statistical controversy. *Psychology, Public Policy, and Law*, 2, 293-323.
- Grove, W.M., Zald, D.H., Lebow, B.S., Snitz, B.E., & Nelson, C. (2000). Clinical versus mechanical prediction: a meta-analysis. *Psychological Assessment*, 12(1), 19-30.
- Guest, G., Bunce, A., & Johnson, L. (2006). How many interviews are enough? An experiment with data saturation and variability. *Field Methods*, 18, 59.
- Gulley, S.M., & Whitney, D.J., & Devine, D.J. (1995). A meta-analysis of cohesion and performance: Effects of level of analysis and task interdependence. *Small Group Research*, 26, 497-520.
- Hackman, J.R. (1987). The design of work teams. In J. Lorsch (Ed.), *Handbook of organisational behaviour* (pp. 315-342). New York, NY: Prentice Hall.
- Hackman, J.R. (2002). *Leading teams: Setting the stage for great performances*. Boston, MA: Harvard Business School.
- Hackman, J.R., & Wageman, R. (2005). When and how team leaders matter. *Research in Organisational Behaviour*, 26, 37-74.
- Hagen, J., Aiken, M., & Marrett, C.B. (1971). Organisation structure and communications. *American Sociological Review*, 36, 860-871.
- Hair, J.B., Anderson, R.E., Tatham, R.L., & Black, W.C. (1998). *Introduction to Multivariate Analysis*. London: Chapman and Hall.
- Hair, J.F., Black, W.C., Babin, J.B., Anderson, R.E., & Tatham, R.L. (2006). *Multivariate data analyses* (6<sup>th</sup> ed.). Upper Saddle River, NJ: Pearson/Prentice Hall.

- Hair, J.F., Ringle, C.M., & Sarstedt, M. (2011). PLS-SEM: Indeed a silver bullet. *Journal of Marketing Theory and Practice*, 19(2), 139-151.
- Hair, J.F., Sarstedt, C., Ringle, M., & Mena, J.A. (2012). An assessment of the use of partial least squares structural equation modelling in marketing research. *Journal of the Academy of Marketing Science*, 40(3), 414-433.
- Halfhill, T.R., Huff, J.W., Johnson, D.A., Ballentine, R.D., & Beyerline, M.M. (2002). Interventions that work (and some that don't): An executive summary of the organisational change literature. In R.L. Lowman (Ed.), *The California School of Organisational Studies: Handbook of organisational consulting psychology: A comprehensive guide to theory, skills, and techniques* (pp. 619-644). San Francisco, CA: Jossey-Bass.
- Hall, E. (1969). *The hidden dimension*. New York, NY: Anchor.
- Hallam, G., & Partridge, H. (2006). Educating the Millennial generation for evidence-based information practice. *Library Hi Tech*, 24(3), 400-419.
- Haller, A. P. (2012). Concepts of Economic Growth and Development: Challenges of Crisis and of Knowledge, *Economy Transdisciplinarity Cognition*, 15(1), 66-71
- Hammer, M., & Champy, J. (1993). *Reengineering the corporation: a manifesto for business revolution*. London: Nicholas Brearley.
- Hancock, P., Howieson, B., Kavanagh, M., Kent, J., Tempone, I., & Segal, N. (2009). *Accounting for the future: More than numbers*. Strawberry Hills, NSW: Australian Learning and Teaching Council.
- Harrison, R. T. (2017). Leadership, leadership development and all that jazz. *Leadership*, 13(1), 81-99.
- Harrison, D., Price, K, & Bell, M. (1998). Beyond relational demography: Time and the effects of surface and deep-level diversity on work group cohesion. *Academy of Management Journal*, 41(1), 96- 107.
- Harter, J.K., Schmidt, F.L., & Hayes, T.L. (2002). Business-unit level relationship between employee satisfaction, employee engagement, and business outcomes: a meta-analysis. *Journal of Applied Psychology*, 87, 268-279.
- Harvey, O.J., Hunt, D.E., & Schroder, H.M. (1961). *Conceptual systems and personality organisation*. New York, NY: Wiley.
- Harvey P., Stoner, J., Hochwarter, W., & Kacmar, C. (2007). Coping with abusive supervision: The neutralizing effects of ingratiation and positive affect on negative employee outcomes. *The Leadership Quarterly*, 18, 264-280.
- Haslam, S.A. (2004). *Psychology in organisations: The social identity approach*. London, UK: Sage.
- Haslam, S.A., Reicher, S.D., & Hopkins, N. (2005). Social identity and the dynamics of leadership: Leaders and followers as collaborative agents in the transformation of social reality. *The Leadership Quarterly*, 16, 547-568.
- Haslam, S.A., Reicher, S.D., & Platow, M.J. (2011). *The new psychology of leadership: Identity, influence and power*. New York, NY: Psychology Press.

- Hasson, F., Keeney, S., & McKenna, H. (2000). Research guidelines for the Delphi survey technique. *Journal of Advanced Nursing, 32*(4), 1008-1015.
- Hatch, M.J. (1993). The dynamics of organizational culture. *Academy of Management Review, 18*, 657-694.
- Hatfield, E., Cacioppo, & Rapson, R.L. (1994). *Emotional contagion*. Cambridge: Cambridge University Press.
- Hau, K.T., & Marsh, H.W. (2004). The use of item parcels in structural equation modeling: non-normal data and small sample sizes. *The British Journal of Mathematical and Statistical Psychology, 57*(2) 327-351.
- Hay, A., & Hodgkinson, M. (2006). Rethinking leadership: a way forward for teaching leadership? *Leadership & Organisational Development Journal, 27*(2), 144-158.
- Hayduk, L., Cummings, G.G., Boadu, K., Pazderka-Robinson, H., & Boulianne, S. (2007). Testing! Testing! One, Two Three – Testing the theory in structural equation models! *Personality and Individual Differences, 42*(2), 841-850.
- Hayduk, L.A. (1996). *LISREL issues, debates, and strategies*. Baltimore, MD: Johns Hopkins University Press.
- Hazy, J.K. (2006). Measuring leadership effectiveness in complex socio-technical systems. *Emergence: Complexity and Organisation, 8*(3), 58-77.
- Heijmans, R.D.H., & Magnus, J.R. (1986). Asymptotic normality of Maximum Likelihood estimators obtained from normally distribute but dependent observations. *Econometric Theory, 2*, 374-412.
- Helland, M.R., & Winston, B.E. (2005). Towards a deeper understanding of hope and leadership. *Journal of Leadership and Organizational Studies 12*(2), 42-54.
- Helmer, O., & Rescher, N. (1959). On the epistemology of the inexact science. *Management Science, 6*, 25-53.
- Henn, M., Weinstein, M., & Foard, N. (2009). *A Critical Introduction to Social Research*. London, England: Sage Publications.
- Hermida, R., Luchman, J.N., Nicolaidis, V., & Wilcox, C. (2015). The issue of statistical power for overall model fit in evaluating structural equation models. *Computational Methods in Social Sciences, 3*(1), 25-42.
- Herzberg, F. (1966). *Work and the nature of man*. Cleveland, OH: World Publishing.
- Herzberg, F. (1984). Mystery systems shape loyalties. *Industry week, 12*, 101-104.
- Hiney, M. (2015). *What it Means, Why it Is Important and How we Might Protect it*. Brussels: Science Europe.
- Hinkin, T.R. (1995). A review of scale development practices in the study of organisations. *Journal of Management, 21*(5), 967-988.
- Hinsz, V.B., Tindale, R.S., & Vollrath, D.A. (1997). The emerging conceptualization of groups as information processors. *Psychological Bulletin, 121*(1), 43-64.



- Hira, N. (2007). You raised them now manage them. *Fortune*, 155(9), 38-48.
- Hobfoll, S.E., Ennis, N, Johnson, A.P., & Jackson, A.P. (2003). Resource loss, resource gain, and emotional outcomes among inner city women. *Journal of Personality and Social Psychology*, 84, 632-643.
- Hodgkinson, G.P., & Sparrow, P.R. (2006). *What is Strategic Competence and Does it Matter?* [Paper presentation]. Ithaca, NY: Centre for Advanced Human Resource Studies.
- Hoel, H., Cooper, C.L., & Rayner, C. (1999). Workplace bullying. In C.L. Cooper & I.T. Robertson (Eds.), *International Review of Industrial and Organizational Psychology*, 14, 195-230. Chichester: Wiley.
- Hoelter, D.R. (1983). The analysis of covariance structures: goodness-of-fit indices. *Sociological Methods and Research*, 11, 325-344.
- Hoffman, B.J., Bynum, B.H., Piccolo, R.F., & Sutton, A.W. (2011). Person-organization value congruence: How transformational leaders influence work group effectiveness. *Academy of Management Journal*, 54(4), 779-796.
- Hoffman, E.J., Kinlaw, C.S., & Kinlaw, D.C. (2002). Developing superior project teams: A study of the characteristics of high performance in project teams. In D.I. Cleland, J.K. Pinto, & D.P. Slevine (Eds.), *The frontiers of the project management research* (pp. 237-248). Newton Square, PA: Project Management Institute.
- Hoffman, L.R., & Maier, N.R.F. (1961). Quality and acceptance of problem solutions by members of homogeneous and heterogeneous groups. *Journal of Abnormal and Social Psychology*, 62, 401-407.
- Hofmeyr, K. (1998). South African managers need to be more positive. *People Dynamics* 16(10), 16-20.
- Hogan, R., & Kaiser, R.B. (2005). What we know about leadership. *Review of General Psychology*, 9(2), 169-180.
- Hogan, R.T. (1983). A socioanalytic theory of personality. In M. Page (Ed.), *Nebraska Symposium on Motivation* (pp. 58-89). Lincoln, NE: University of Nebraska.
- Hogg, M.A. (2001). A social identity theory of leadership. *Personality and Social Psychology Review*, 5, 184-200.
- Hogg, M.A., & van Knippenberg, D. (2003). Social identity and leadership processes in groups. *Advances in Experimental Social Psychology*, 35, 1-52.
- Hollenbeck, G.P., McCall Jr., M.W., & Sizler, R.B. (2006). Theoretical and practitioner letters: Leadership competency models. *The Leadership Quarterly*, 17, 398-413.
- Holmes, A., & Miller, S. (2000) A case for advanced skills and employability in higher education. *Journal of Vocational Education and Training*, 52, 653-664.
- Holmes, L. (2013). Competing perspectives on graduate employability: possession, position, or process? *Studies in Higher Education*, 38(4), 538-554.
- Hooper, D., Coughlan, J., & Mullen, M. (2008). Structural equation modelling: Guidelines for determining model fit. *Electronic Journal of Business Research Methods*, 6(1), 53-60.

- Horn, L., Graham, C., Prozesky, H., & Theron, C.C. (2015). *Getting ethics approval for your research project*. Cape Town: Stellenbosch University.
- Horwitz, F.M., Bowmaker-Falconer, A., & Searll, P. (1996). Human resource development and managing diversity in South Africa. *International Journal of Manpower*, 17 (4/5), 134-151.
- Hoskisson, R.E., Hitt, A., & Ireland, R.D. (2007). *Strategic Management: Competitiveness and Globalisation*. Cincinnati, OH: Thomson South-Western.
- Hoult, J. (1986) Community care of the acute mentally ill. *British Journal of Psychiatry*, 149, 137-144.
- House, J.S. (1981). *Work stress and social support*. Boston, MA: Addison.
- House, R.J., & Baetz, M.L. (1979). Leadership: Some generalisations and new research directions. In B.M. Staw (Ed.), *Research in organisational behaviour* (pp. 341-423). Greenwich CT: JAI.
- House, R.J., & Podsakoff, P.M. (1994). Leadership effectiveness: Past perspectives and future directions for research. In J. Greenberg (Ed.) *Organizational behaviour: The state of the science* (pp. 54-82). Hillsdale, NJ: Erlbaum.
- House, R.J., & Shamir, B. (1993). Toward the integration of transformational, charismatic, and visionary theories. In R. Ayman & M.M. Chemers. (Eds.), *Leadership theory and research: Perspectives and directions* (pp. 81-107). San Diego, CA: Academic Press.
- Howell, J.M., & Avolio, B.J. (1992). The ethics of charismatic leadership: Submission or liberation? *The Executive*, 6(2), 43-54.
- Howell, J.M., & Shamir, B. (2005). The role of followers in the charismatic leadership process: Relationships and their consequences. *Academy of Management Review*, 30(1), 96-112.
- Hsu, C., & Sandford, A.S. (2007). The Delphi technique: Making sense of consensus. *Practical Assessment, Research & Evaluation*, 12(10), 1-8.
- Hu, J., & Liden, R.C. (2011). Antecedents of team potency and team effectiveness: An examination of goal and process clarity and servant leadership. *Journal of Applied Psychology*, 96(4), 851-862.
- Hu, L., & Bentler, P.M. (1995). Evaluating model fit. In R.H. Boyle (Ed.), *Structural Equation Modelling: Concepts, Issues and Applications* (pp. 76-99). London: Sage.
- Hu, L.T., & Bentler, P.M. (1999). Cut-off criteria for fit indexes in covariance structure analysis: Conventional criteria cersus new alternatives. *Structural Equation Modelling*, 6(1), 1-55.
- Hughes, T.A. (2014). *Idealised, inspirational, and intellectual leaders in the social sector: Transformational leadership*. (Published Senior thesis). Claremont McKenna College, Claremont, California.
- Hunt, S. (1996). Generic work behaviour: An investigation into the dimensions of entry-level, hourly job performance. *Personnel Psychology*, 49(1), 51-83.
- Hunter, M.D. (2014). *Extended structural equations and state space model when data are missing at random*. [Paper presentation]. The Association of Psychological Science, California.

- Huq, A., & Gilbert, D.H. (2013). Enhancing graduate employability through work-based learning in social entrepreneurship. *Education and Training, 55*(6), 550-572.
- Hutchinson, S.R., & Olmos, A. (1998). Behaviour of descriptive fit indexes in confirmatory factor analysis using ordered categorical data. *Structural Equation Modelling: A Multidisciplinary Journal, 5*, 344-364.
- Iacobucci, D. (2010). Structural equations modelling: Fit indices, sample size, and advanced topics. *Journal of Consumer Psychology, 20*, 90-98.
- Igwe, A., Onwumere, J., & Egbo, O.P. (2014). Effective Human Resource Management as a Tool for Organisational Success. *European Journal of Business and Management, 6*(30), 210-218.
- Jackson, D.L. (2003b). Revisiting sample size and number of parameter estimates: Some support for the N:q hypothesis. *Structural Equation Modelling, 10*, 128-141.
- Jackson, J.H., & Morgan, C.P. (1982). *Organisation Theory*. Englewood Cliffs, NJ Prentice-Hall.
- Jackson, M. (2003a). *Systems Thinking: Creative Holism for Managers*. Chichester: John Wiley & Sons Ltd.
- Jackson, T. (1999). Managing change in South Africa: Developing people and organizations. *International Journal of Human Resource Management, 10*(2), 306-326
- Jackson, T. (2004). *Management and change in Africa: A cross-cultural perspective*. London: Routledge.
- Jacobs, J.M. (1996). *Essential assessment criteria for physical education teacher education programs: A Delphi study*. (Unpublished doctoral dissertation). West Virginia University, Morgantown, West Virginia.
- Jaques, E. (1970). *Work, Creativity and Social Justice*. London: Heinemann Educational.
- Jaques, E. (1996). *Requisite organisation*. Gloucester, MA: Cason Hall.
- Jarvenpaa, S.L., & Leidner, D.E. (1999). Communication and trust in global virtual teams. *Organisation Science, 10*(6) 791-815.
- Jarzabkowski, P., & Searle, R.H. (2004) Harnessing Diversity and Collective Action in the Top Management Team. *Long Range Planning, 37*, 399-419.
- Jehn, K., & Bezrukova, K. (2010). The fault line activation process and the effects of activated fault lines on coalition formation, conflict, and group outcomes. *Organizational Behaviour and Human Decision Processes, 112*(1), 24-42.
- Jehn, K.A. (1995). A multimethod examination of the benefits and detriments of intragroup conflict. *Administrative Science Quarterly, 40*, 256-282.
- Jehn, K.A. (1997). A qualitative analysis of conflict types and dimensions in organizational groups. *Administrative science quarterly, 42*, 530-557.
- Jehn, K.A., & Chatman, J.A. (2000). The influence of proportional and perceptual conflict composition on team performance. *The International Journal of Conflict Management, 11*, 56-73.

- Jehn, K.A., & Mannix, E.A. (2001). The dynamic nature of conflict: A longitudinal study of intragroup conflict and group performance. *Academy of Management Journal*, 44, 238-251.
- Jiang, K., Lepak, D.P., Han, H., Hong, Y., Kim, A., & Winkler, A.L. (2012). Clarifying the construct of human resource systems: Relating human resource management to employee performance. *Human Resource Management Review*, 22, 73-85.
- Jivan, M.E., Zarandi, M. (2012). Factors effective on knowledge management in service-orientated organisations (Senior managers opinion using Analytical Hierarchy Process (AHP). *International Journal of Business and Management*, 7(5), 150-158.
- Johnson, D.R., & Creech, J.C. (1983) Ordinal measures in multiple indicator models: A simulation study of categorization error. *American Sociological Review*, 48, 398-407.
- Johnson, G., Scholes, K., & Whittington, R. (2008). *Exploring Corporate Strategy: Texts and Cases*. London: Prentice Hall.
- Jokinen, T. (2005). Global leadership competencies: a review and discussion. *Journal of European Industrial Training*, 29(2/3), 199.
- Jonas-Dwyer, D., & Pospisil, R. (2004). *The Millennial effect: implications for academic development*. Retrieved July 7, 2016 from <http://www.herdsp-a.org.au/newsite/wp/wp-content/uploads/conference/2004/PDF/PO50-jt.pdf>.
- Jones, D.C., Kalmi, P., & Kauhanen, A. (2010). Teams, incentive pay, and productive efficiency: Evidence from a food-processing plant. *Industrial and Labour Relations Review*, 63(4), 606-626.
- Jöreskog, K.G. (1973). A general method for estimating a linear structural equation system, in structural equation models in the social sciences. In O.D. Duncan & A.S. Golderberger (Eds.), *Structural Equation Models in the Social Sciences* (pp. 85-112). New York, NY: Seminar Press.
- Jöreskog, K.G. (1994). On the estimation of polychoric correlations and their asymptotic covariance matrix. *Psychometrika*, 59(3), 381-389.
- Jöreskog, K.G., & Sörbom, D. (1993). *LISREL 8 User's Reference Guide*. Chicago, IL: Scientific Software.
- Jöreskog, K.G., & Sörbom, D. (1996a). *LISREL 8: User's Reference Guide*. Lincolnwood, IL: Scientific Software International
- Jöreskog, K.G., & Sörbom, D. (1996b). *PRELIS2: User's reference guide*. Chicago, IL: Scientific Software International.
- Jöreskog, K.G., & Sörbom, D. (2003). *LISREL 8: New Statistical Features*. Lincolnwood, IL: Software International.
- Jorgensen, B. (2003). Baby boomers, generation X and generation Y. *Foresight*, 4(4), 41-49.
- Jose, A., & Thibodeaux, M.S. (1999). Institutionalisation of ethics: The perspective of managers. *Journal of Business Ethics*, 22, 133-143.

- Joubert, K.L. (2016). *An elaboration and modification of the May, Gilson, and Harter (2004) employee engagement structural model*. (Unpublished Master's thesis). University of Stellenbosch, Stellenbosch, South Africa.
- Judge, T., & Watanabe, S. (1993). Another look at the job satisfaction-life satisfaction relationship. *Journal of Applied Psychology, 78*(6), 939-948.
- Judge, T.A., Picollo, R.F., & Ilies, R. (2004). The forgotten ones? The validity of consideration and initiating structure in leadership research. *Journal of Applied Psychology, 89*, 36-51.
- Judge, T.A., Thoreson, C.J., Bono, J.E., & Patton, G.K. (2001). The Job-Satisfaction-Job Performance Relationship: A Qualitative and Quantitative Review. *Psychological Bulletin, 127*(3), 376-407.
- Kampen, J., & Swyngedouw, M. (2000). The ordinal controversy revisited. *Quality & Quantity, 34*, 87-102.
- Kane, J.S. (1986). Performance distribution in assessment. In R.A. Berk (Ed.), *Evaluating Dynamic Performance assessment: Methods and applications* (pp. 237-273). Baltimore, MD: Johns Hopkins University.
- Kantabutra, S. (2009). A behavioural theory of vision in organizational settings. *Leadership and Organization Development Journal, 30*(4), 319-337.
- Kaplan, D. (2000). *Structural equation modelling: Foundation and extensions*. Thousand Oaks, CA: Sage.
- Kaplan, R.S., & Norton, D.P. (1992). The balanced scorecard – measures that drive performance. *Harvard Business Review, 70*, 71-79.
- Karasek, R.A. (1979). Job demands, job decision latitude and mental strain: Implications for crafters of their work. *Academy of Management Review, 26*, 179-201.
- Kark, R., Shamir, B., & Chen, G. (2003). The two faces of transformational leadership: Empowerment and dependency. *Journal of Applied Psychology, 88*, 246-255.
- Katz, D., & Kahn, R. (1978). *The social psychology of organisations*. New York: Wiley.
- Katz-Navon, T.Y., & Erez, M. (2004). When collective- and self-efficacy affect team performance: The role of task interdependence. *Small Group Research, 36*(4), 437-465.
- Kelley-Patterson, D., & George, C. (2002). Mapping the contract: an exploration off the comparative expectations of graduate employees and human resource managers within the hospitality, leisure and tourism industries in the United Kingdom. *Journal of Services Research, 2*(1), 55-74.
- Kelloway, E.K. (1998). *Using LISREL for structural equation modelling: A researcher's guide*. London: Sage.
- Kelloway, E.K., Turner, N., Barling, J., & Loughlin, C. (2012). Transformational leadership and employee psychological well-being: The mediating role of employee trust in leadership. *Work & Stress: An International Journal of Work, Health & Organisations, 26*(1), 39-55.
- Kenny, D. (2015). *SEM: Fit*. Retrieved December 2, 2019 from <http://davidakenny.net/cm/fit.htm>.

- Kenny, D.A., & Kashy, D.A. (1992). Analysis of the Multitrait-Multimethod Matrix by Confirmatory Factor Analysis. *Psychological Bulletin*, 112(1), 165-172.
- Kenny, D.A., Kaniskan, B., & McCoach, D.B. (2014). The performance of RMSEA in models with small degrees of freedom. *Sociological Methods & Research*, 44(3), 391-426.
- Kerlinger, F.N. (1973). *Foundations of behavioural research*. New York, NY: Holt, Rinehart, and Winston.
- Kerlinger, F.N. (1986) *Foundations of Behavioural Research*. Holt, New York, NY: Rinehart and Winston.
- Kerlinger, F.N., & Lee, H.B. (2000). *Foundations of behavioural research*. Fort Worth, TX : Harcourt College Publishers.
- Kerslake, P. (2005). Words from the Y's. *New Zealand Management*, 52(4), 44-46.
- Keyton, J. (2005). *Communication and organizational structure: A key to understanding work experiences*. Thousand Oaks, CA: SAGE.
- Khaleelee, O., & Woolf, R. (1996). Personality, life experience and leadership capability. *Leadership and Organisational Development Journal*, 17(6), p. 5-11.
- Khan, W.A. (1990). Psychological conditions of personal engagement and disengagement at work. *Academy of Management Journal*, 33(4), 692-724.
- Khan, W.A. (1992). To be full there: psychological presence at work. *Human Relations*, 45, 321-349.
- Khatri, P., Gupta, S., Gulati, K., Chauha, S. (2010). Talent Management in HR. *Journal of Management and Strategy*, 1(1), 39-46.
- King, Z. (2003). New or traditional careers? A study of graduates' preferences. *Human Resource Management Journal*, 13(1), 5-28.
- Kinnear, T., & Taylor, J. (1991). *Marketing research: an applied approach*. New York, NY: McGraw-Hill.
- Kirsch, D.A, Mitsihashi, H., & Sine, W.D. (2006). Revisiting Burns and Stalker: Formal structure and new venture performance in emerging economic sectors. *Academy of Management Journal*, 49(1), 121-132.
- Klee, A.J. (1972). The utilization of expert opinion in decision-making. *AIChE Journal*, 18(6), 1107-1115.
- Klein, K.J., Knight, A.P., Ziegert, J.C., Limi, B.C., & Saltz, J.L. (2011). When team members' values differ: The moderating role of team leadership. *Organizational Behaviour and Human Decision Processes*, 114, 25-36.
- Klimoski, R., J., & Mohammed, S. (1994). Team mental model: Construct or metaphor? *Journal of Management*, 20, 403-437.
- Kline, R.B. (2005) *Principles and Practice of Structural Equation Modeling* (2<sup>nd</sup> ed.). New York, NY: The Guilford Press.

- Kline, R.B. (2011). *Principles and practice of structural equation modeling* (3<sup>rd</sup> ed.). New York, NY: Guilford Press
- Knouse, S.B. (2007). Building task cohesion to bring teams together. *Quality Progress*, 40(3), 49-53.
- Komane, T. (2014). The challenge of mediating diverse cultural values in the workplace using South Africa's constitutional framework. *Journal of Leadership and Management*, 1(2), 120-129.
- Konovsky, M.A. (2000). Understanding procedural justice and its impact on business organizations. *Journal of Management*, 26(3), 489-511.
- Koopmans, L., Bernaards, C.M., Hildebrandt, V.H., Schaufeli, W.B., de Vet, H.C.W., & van der Beek, A. (2011). Conceptual frameworks of individual work performance: A systematic review. *Journal of Occupational and Environmental Medicine*, 53(8), 856-866.
- Kopelman, R.E., Prottas, D.J., & Davis, A.L. (2008). Douglas McGregor's Theory X and Y: Toward a Construct-valid measure. *Journal of Managerial Issues*, Vol XX (2), 255-271
- Korsgaard, M.A., Schweiger, D.M., & Sapienza, H.J. (1995). Building commitment, attachment, and trust in strategic decision-making teams: The role of procedural justice. *Academy of Management Journal*, 35, 60- 84.
- Kotter, J.P. (1990). *A force for change: How leadership differs from management*. New York, NY: Free Press.
- Kotter, J.P., & Heskett, J.L. (1992). *Corporate Culture and Performance*. New York, NY: The Free Press, 1992.
- Kotterman, J. (2006). Leadership vs Management: What's the difference? *Journal for Quality & Participation*, 29(2), 13-17.
- Kouzes, J.M., & Posner, B.Z. (2002). *The Leadership Challenge: How to keep getting extraordinary things done in organisations*. San Francisco, CA: Jossey-Bass.
- Kouzes, J.M., & Posner, B.Z. (2010). *The Leadership Challenge: How to keep getting extraordinary things done in organisations*. San Francisco, CA: Jossey-Bass.
- Kozlowski, S.W.J. (1998). Training and developing adaptive teams: theory, principles, and research. In J.A. Cannon-Bowers & E. Salas (Eds.), *Making decisions under stress: implications for individual and team training* (pp. 115-153). Washington, DC: American Psychological Association.
- Kozlowski, S.W.J., & Bell, B.S. (2003). Work groups and teams in organisations. In W.C. Borman, D. R. Ilgen, & R.J. Klimoski (Eds.), *Handbook of psychology* (pp. 333-375). New York, NY: Wiley-Blackwell.
- Kozlowski, S.W.J., & Salas, E. (1997). An organisational systems approach for the implementation and transfer of training. In J.K. Ford, S.W.J. Kozlowski, K., Kraiger, E. Salas, & M. Teachout (Eds.), *Improving training effectiveness in work organisations* (pp. 247-287). Mahwah, NJ: Erlbaum.
- Kozlowski, S.W.J., Gully, S.M., McHugh, P., Salas, E., & Cannon-Bowers, J.A. (1996). A dynamic theory of leadership and team effectiveness: Developmental and task contingent roles. In

- G Ferris (Ed.), *Research in personnel and human resource management*, (pp. 253-305). Greenwich, CT: JAI Press.
- Kram, K.E. (1983). Phases of the mentor relationship. *Academy of Management Journal*, 26, 608-625.
- Kraut, R.E., & Streeter, L.A. (1995). Coordination in software development. *Communications of the ACM*, 38(3), 69–81.
- Kruger, S. (1995). *New management thinking into the 21st century*. Unpublished class notes. Johannesburg: RAU.
- Kumar, K.S., & Ramesh, R. (2014). Role of employee empowerment in organisational development. *International Journal of scientific research and management*, 2(8), 1241-1245.
- Kumar, S. (2015). Structure equation modeling basic assumptions and concepts: A novice's guide. *Asian Journal of Management Sciences*, 3(7), p. 25-28.
- Kuntze, R., & Matulich, E. (2010). Google: Searching for Value. *Journal of Case Research in Business and Economics*, 2, 1-10.
- Kupritz, V.W. (2002). The relative impact of workplace design on training transfer. *Human Resource Development Quarterly*, 13(4), 427-447.
- Labuschagne, A. (2003). Qualitative research - Airy fairy or fundamental? *The Qualitative Report*, 8(1), 100-103.
- Lacey, M.Y., & Groves, K. (2014). Talent management collides with corporate social responsibility: creation of inadvertent hypocrisy. *Journal of Management Development*, 33, 399-409.
- Lance, C.E., Noble, C.L., & Scullen, S.E. (2000). A critique of the correlated trait–correlated method and correlated uniqueness models for multitrait–multimethod data. *Psychological Methods*, 7(2), 228–244.
- Landy, F.J. (1986). Stamp collecting versus science: Validation as hypothesis testing. *American Psychologist*, 41, 1183-1192.
- Landy, F.J., & Schmitt, N. (1993). The concept of validity. In W. Borman & N. Schmitt (Eds.), *Personnel selection in organizations* (pp.275-309). San Francisco, CA: Jossey-Bass Publishers.
- Lanzetta, J.T., & Roby, T.B. (1960). The relationship between certain group process variables and group problem-solving efficiency. *Journal of Social Psychology*, 52, 135 – 148.
- Lastovicka, J.L., Murray, J.P., & Joachimsthaler, E. (1990). Evaluating the measurement validity of lifestyle typologies with qualitative measures and multiplicative factoring. *Journal of Marketing Research*, 28, 11-23.
- Laub, J. (1999). Assessing the servant organisation: Development of the servant organisational leadership (SOLA) instrument. *Dissertation Abstracts International*, 60(2), 308.
- Lavine, M. (2014). Paradoxical leadership and the Competing Values Framework. *The Journal of Applied Behavioural Science*, 50(2), 189–205.



- Lawler, E.E., & Worley, C. (2006). *Built to Change*. San Francisco, CA: Jossey-Bass.
- Lawler, E.J., Thye, S., & Yoon, J. (2008). Commitment in structurally enabled and induced exchange relations. *Social Psychology Quarterly*, 69(2), 183-200.
- Lazarova, M.B. & Thomas, D.C (2014). *Essentials of Human Resource Management: Managing People Globally*. Los Angeles: SAGE.
- Le Deist, F.O.D., & Winterton, J. (2005). What is competence? *Human Resource Development International*, 8(1), 27-46.
- Lee, A. (2016). *Development and Empirical Evaluation of an Explanatory Psychological Ownership Structural Model*. (Unpublished Master's thesis). University of Stellenbosch, Stellenbosch, South Africa.
- Lekka-Kowalik, (2010). Why science cannot be value-free: Understanding the rationality and responsibility of science. *Science and Engineering Ethics*, 16, 33-41.
- Lepak, D.P., & Liao, H., Chung, Y., & Harden, E.E. (2006). A conceptual overview of human resource management systems in strategic human resource management research. In J.J. Martocchio (Ed.), *Research in personnel and human resource management* (pp. 217-271). Greenwich, CJ: JAI Press.
- Leuven, E., & Oosterbeck, H. (2001). Overeducation and mismatch in the labour market. *Handbook of the Economics of Education*, 4, 283-326.
- Levy, O., & Taylor, S., Boyacigiller, N., & Beechler, S. (2007). What we talk about when we talk about 'Global Mindset': Managerial cognition in multinational corporations. *Journal of International Business Studies*, 38, 231-258.
- Lewin, K. (1943). Psychological ecology. In: D. Cartwright (Ed.), *Field Theory in Social Science* (pp. 170-187). London: Social Science Paperbacks.
- Lewis, D. (2003). Theorising the organisation and management of non-governmental development organisations towards a composite approach. *Public Management Review*, 5(3), 325-344.
- Lewis, D.J., & Weigert, A. (1985). Trust as a social reality. *Social Forces*, 63(4), 967-85.
- Li, C. (2014). *The performance of MLR, USLMV, and WLSMV estimation in structural regression models with ordinal variables*. (Published Doctoral thesis). Michigan State University, Michigan, USA.
- Lichtenstein, B.B., Uhl-Bien, M., Marion, R., Seers, A., Orton, J.D., & Schreiber, C.J. (2006). Complexity leadership theory: An interactive perspective on leading in complex adaptive systems. *Emergence, Complexity, and Organisations*, 8(4), 2-12.
- Liden, R.C., Wayne, S.J., & Sparrowe, R.T. (2000). An examination of the mediating role of psychological empowerment and the relations between the job, interpersonal relationship, and work outcomes. *Journal of Applied Psychology*, 85, 407-416.
- Liden, R.C., Wayne, S.J., Zhao, H., & Henderson, D. (2008). Servant leadership: Development of a multidimensional measure and multi-level assessment. *The Leadership Quarterly*, 19, 161-177.

- Lincoln, Y.S. (1995). Emerging criteria for quality in qualitative research. *Qualitative Inquiry*, 1, 275-289
- Lincoln, Y.S., & Guba, E. (1985). *Naturalist Enquiry*. Newbury Park, CA: Sage.
- Lindell, M.K., & Whitney, D.J. (2001). Accounting for common method variance in cross-sectional designs. *Journal of Applied Psychology*, 86, 114-121.
- Lindell, M.K., Brandt, C.J. (2000). Climate quality and climate consensus as mediators of the relationship between organisational antecedents and outcomes. *Journal of Applied Psychology*, 85, 114-121.
- Lindorff, M. (2010). Ethics, ethical human research and human research ethics committees. *Australian Universities' Review*, 52(1), 51-59.
- Lindquist, T.M. (2008). Recruiting the millennium generation: the new CPA. *The CPA Journal*, 78(8), 56-59.
- Linstead, S., & Grafton-Small, R. (1992). On reading organisational culture. *Organisation Studies*, 13(3), 331-355.
- Lissitz, R.W., & Green, S.B. (1975). Effect on the number of scale points on reliability: a Monte Carlo Approach. *Journal of Applied Psychology*, 60, 10-13.
- Little, T.D., & Rhemtulla, M., & Gibson, K. (2013). Why the item versus parcels controversy needn't be one. *Psychological Methods*, 18(3), 285-300.
- Loughlin, C., & Barling, J. (2001). Young workers, work values, attitudes, and behaviours. *Journal of Occupational Psychology*, 74(4), 543-558.
- Lu, L. (2015). Building trust and cohesion in virtual teams: the developmental approach. *Journal of Organizational Effectiveness: People and Performance*, 2(1), 55-72.
- Ludwig, B.G. (1994). *Internationalizing Extension: An exploration of the characteristics evident in a state university extension system that achieves internationalization*. (Unpublished Doctoral dissertation). Columbus, OH: The Ohio State University.
- Luhmann, N. (1990). Erfassung als evolutionäre Errungenschaft. *Rechtshistorisches Journal*, 9, 176-220.
- Lumley, E.J., Coetzee, M., Tladinyane, R.T., & Ferreira, N. (2011). Exploring the job satisfaction and organisational commitment of employees in the information technology environment. *Southern African Business Review*, 15(1), 100-118.
- Lunenburg, F.C. (2011). Leadership versus Management: A key distinction – At least in theory. *International Journal of Management, Business, and Administration*, 14(1), 1-4.
- Luscombe, J., Lewis, I., & Biggs, H.C. (2012). Essential elements for recruitment and retention: Generation Y. *Education and Training*, 55(3), 272-290.
- Lussier, R.N., & Achua, C.F. (2004). *Leadership theory, application and skill development*. USA: Thomson South Western.
- Luthans, F., & Youssef, C.M. (2007). Positive organisational behaviour in the workplace: The impact of hope, optimism, and resilience. *Journal of Management*, 33(5), 774-800.

- Lyons, S. (2003). *An exploration of generational values in life and at work*. (Published Doctoral thesis). Eric Sprott School of Business, Ottawa, Canada.
- Maccallum, R.C. (1995). Model specification: procedure, strategies, and related issues. In R.H. Hoyle, *Structural Equation modeling: concepts, issues and applications* (pp. 16-36). Newbury Park, CA: Sage.
- MacCallum, R.C., & Hong, S. (1997). Power analysis for covariance structure models using GFI and AGFI. *Multivariate Behavioural Research*, 31, 193-210.
- MacCallum, R.C., Browne, M.W., & Sugawara, H.M. (1996). Power analysis and determination of sample size for covariance structure modeling. *Psychological Methods*, 1(2), 130-149.
- Maccoby, M. (2000). Narcissistic leaders: The incredible pros, the inevitable cons. *Harvard Business Review*, 78, 68-77.
- Macfarlane, B. (2009) *Researching with Integrity: the ethics of academic enquiry*. New York, NY: Routledge.
- Mael, F.A., & Alderks, C.E. (1993). Leadership, team cohesion and subordinate work unit morale, and performance. *Military Psychology*, 5(3), 141-158.
- Mael, F.A., Ashforth, B.E. (1995). Loyal from day one: Biodata, organisational identification, and turnover among newcomers. *Personnel Psychology*, 48, 409-433.
- Mahembe, B. (2014). *The development and empirical evaluation of an extended learning potential structural model*. (Published Doctoral thesis). University of Stellenbosch, Stellenbosch, South Africa.
- Malhotra, N.K. (1996). *Marketing Research: An Applied Orientation*. Upper Saddle River, NJ: Prentice Hall.
- Manetje, O., & Martins, N. (2009). The relationship between organisational culture and organisational commitment. *South African Business Review*, 13(1), 87-111.
- Mannix, E., & Neale, M. (2005). What differences make a difference: The promise and reality of diverse teams in organizations. *Psychological Science in the Public Interest: A Supplement to Psychological Science*, 6(2), 31-55.
- Manochehri, M.A., & Malekmohammadi, M. (2015). The Relationships between job burnout and job performance in employees of Sepah Bank, Gorgan, Iran. *Journal of Applied Environmental Biological Science*, 5(8), 166-170.
- March, J.G., & Simon, H.A. (1958). *Organisations*. New York, NY: John Wiley.
- Marion, R., & Uhl-Bien, M. (2001). Leadership in complex organisations. *Leadership Quarterly*, 12, 389-418.
- Maritz, D. (2000). South African leaders' emergence towards transformational leadership, *Management Today*, July, 16-18.
- Maritz, G. (2002). The most critical issues facing managers in South Africa Today. *Acta Commercii*, 2, 1-10.

- Marks, M.A., Zaccaro, S.J., & Mathieu, J. (2000). Performance implications of leader briefings and team interaction training for team adaptation to novel environments. *Journal of Applied Psychology, 85*, 971-986.
- Markus, H. R., & Nurius, P. (1986). Possible Selves. *American Psychologist, 41*, 954-969.
- Markus, L.H., Cooper-Thomas, H.D., & Allpress, K.N. (2005). Confounded by competencies? An evaluation of the evolution and use of competency models. *New Zealand Journal of Psychology, 34*(2), 117-126.
- Marquardt, M. (2004). *Optimizing the Power of Action Learning: Solving Problems and Building Leaders in Real Times*. Palo Alto, CA: Davies-Black.
- Marrelli, A.F., Tondora, J., & Hoge, M.A. (2005). Strategies for developing competency models. *Administration and Policy in Mental Health, 32*(5/6), 533-561.
- Marsh, H.W. (1989). Confirmatory factor analyses of multitrait-multimethod data: Many problems and a few solutions. *Applied Psychological Measurement, 13*, 335-361.
- Marsh, H.W., & Grayson, D. (1995). Latent variable models of Multitrait-Multimethod data. In R.H. Hole (Ed.), *Structural equation modeling: Concepts, issues and applications* (pp. 177-198). Thousand Oaks: Sage Publications.
- Martin, C.A. (2005). From high maintenance to high productivity: what managers need to know about Generation Y. *Industrial and Commercial Training, 37*(1), 39-44.
- Martinelli, D., & Erzikova, E. (2017). Public relations leadership development cycle: A cross-cultural perspective. *Public Relations Review, 43*, 1062-1072.
- Martins, N. (1989). *Organisational culture in a financial institution*. (Unpublished Doctoral thesis). University of Pretoria, Pretoria, South Africa.
- Maslach, C., Schaufeli, W.B., & Leiter, M.P. (2001). Job burnout. *Annual Review of Psychology, 52*, 397-422.
- Maslow, A. (1961). *Toward a psychology of being*. New York, NY: Van Nostrand.
- Maslow, A.H. (1971). *The farther reaches of human nature*. New York, NY: Viking Press.
- Mason, R. (2007). The external environment's effect on management and strategy. A complexity theory approach. *Management Decision, 45*(1), 10-28.
- Mat., J. (2008). *The Influence of Leadership Style on Internal Marketing in Retailing*. (Published Doctoral thesis). University of Stirling, Scotland, United Kingdom.
- Mateus, A.D., Allen-Ile, C., & Iwu, C.G. (2014). Skills shortage in South Africa: Interrogating the repertoire of discussions. *Mediterranean Journal of Social Sciences, 5*(6), 63-73.
- Mathur, P. (2015). Achieving Competitive Advantage Through Employees. *International Journal of Arts, Humanities and Management studies, 1*(9), 66-71.
- Matheson, T. (2013). Enterprise Operations. *Financial Management, 23*, 4-14.

- Mathieu, J.E., Kukenberger, M.R., D'Innocenzo, L., & Reilly, G. (2015). Modelling reciprocal team cohesion-performance relationships, as impacted by shared leadership and members' competence. *Journal of Applied Psychology, 100*(3), 713-734.
- Mattone, J., Xavier, L. (2013). *Talent Leadership: A Proven Method for Identifying and Developing High-Potential Employees*, AMACOM.
- Matsunaga, M (2008). Item parceling in structural equation modelling: A primer. *Communication Methods and Measures, 2*(4), p. 260-293.
- Maxwell, G.A., & Ogder, S.M., & Broadbridge, A.M. (2007). Experiences, perceptions and expectations of retail employment for Generation Y. *Career Development International, 12*(6), 523-546.
- Mayer, R.C., Davis, J.H., & Schoorman, F.D. (1995). An integrative model of organizational trust. *Academy of Management Review, 20*, 709-734.
- Mazur, B. (2010). Cultural diversity in organisational theory and practice. *Journal of Intercultural Management, 2*(2), 5-15.
- Mbigi, L. (1997). *The African Dream in Management*. Randburg: Knowledge Resources.
- McCall, M.W., Jr., Lombardo, M.M., & Morrison, A.M. (1988). *The lessons of experience: How successful executives develop on the job*. Lexington, MA: Lexington Books.
- McCann, J., & Holt, R. (2009). Ethical leadership and organisations: an analysis of leadership in the manufacturing industry based on the perceived Leadership Integrity Scale. *Journal of Business Ethics, 87*, 211-220.
- McCann, J.T., Graves, D., & Cox, L. (2014). Servant leadership, employee satisfaction, and organisational performance in rural community hospitals. *International Journal of Business and Management, 9*(10), 28-38.
- McCauley, C.D., & Brutus, S. (1998). *Management development through job experiences: An annotated bibliography*. Greensboro, NC: Center for Creative Leadership.
- McClelland, D.C. (1961). *The Achieving Society*. New York, NY: Free Press.
- McClelland, D.C. (1973). Testing for competence rather than for 'intelligence.' *American Psychologist, 28*, 1-14.
- McCracken, M., Currie, D., & Harrison, J (2016). Understanding graduate recruitment, development and retention for the enhancement of talent management: Sharpening 'the edge' of graduate talent. *International Journal of Human Resource Management, 27*(22), 2727-2752.
- McCracken, M., Heaton, N., & Harrison, J. (2008). Graduate recruitment and development: Sector influence on a local market/regional economy. *Education and Training, 50*(4), 276-288.
- McDonald, R.P. (1999). *Test theory: A unified treatment*. Mahwah, NJ: Lawrence Erlbaum.
- McDonald, R.P., & Ho, M.H (2002). Principles and practice in reporting structural equation analyses. *Psychological Methods, 7*(1), 64-82.

- McGowan, P., & Miller, J. (2001). Management vs. leadership. *School Administrator*, 58(10), 32-34.
- McGregor, D.M. (1960). *The Human Side of Enterprise*. New York, NY: McGraw-Hill.
- McGuire, J.B., & Rhodes, G.B. (2009). *Transforming your leadership culture*. San Francisco, CA: Jossey-Bass.
- McNealy, J.M. (1999). *Best practices to develop situational awareness in dynamic small group military settings*. (Published Master's thesis). University of North Carolina, Chapel Hill, North Carolina.
- McQuitty, S. (2004). Statistical power and structural equation models in business research. *Journal of Business Research*, 57(2), 175-183.
- Meehl, P. E. (1970). Nuisance variables and the ex post facto design. In M. Radner & S. Winokur (Eds.), *Minnesota Studies in the philosophy of science: Vol. IV. Analyses of theories and methods of physics and psychology* (pp. 373-402). Minneapolis: University of Minnesota Press.
- Meehl, P.E. (1954). *Clinical versus statistical prediction: A theoretical analysis and a review of the evidence*. Minneapolis, MN: University of Minnesota Press.
- Mele, C., Pels, J., & Polese, F. (2010). A Brief Review of Systems Theories and Their Managerial Applications. *Service Science*, 2(1/2), 126-135.
- Mels, G. (2003). *A workshop on structural equation modelling with LISREL 8.54 for Windows*. Chicago: Scientific Software International.
- Mels, G. (2010). *Structural Equation Modelling with LISREL 9 for Windows*. Chicago: Scientific Software International.
- Merritt, E.A. (2009). *Leadership strategy*. Retrieved January 13, 2016 from <http://edwardmerritt.blogspot.com>.
- Messick, S. (1989). Validity. In R.L. Linn (Ed.), *Educational measurement* (pp. 13-104). New York, NY: American Council on Education and McMillan Publishing Company.
- Meyerson, S.L., & Kline, T.J.B. (2007). Psychological and environmental empowerment: Antecedents and consequences. *Leadership and Organisation Development Journal*, 29(5), 444-460.
- Mickan, S., & Rodger, S. (2005). Effective health care teams: a model of six characteristics developed from shared perceptions. *Journal of Interprofessional Care*, 19(4), 358-370.
- Miles J., & Shevlin, M. (1998). Effects of sample size, model specification and factor loadings on the GFI in confirmatory factor analysis. *Personality and Individual Differences*, 25, 85-90.
- Miles, D.E., Borman, W.E., & Spector, P.E., & Fox, S. (2002). Building an integrative model of extra role work behaviours: A comparison of counterproductive work behaviour with organisational citizenship behaviour. *International Journal of Selection and Assessment*, 10, 51-57.
- Militaru, C., & Zanfir, A. (2012). The influence of organisational culture over the ethical principles in international business. *International Journal of Academic Research in Accounting, Finance and Management Sciences*, 2(1), 26-33.

- Miller, S., & Selgelid, M.J. (2007). Ethical and philosophical consideration of the dual-use dilemma in the biological sciences. *Science and Engineering Ethics, 13*, 523-580.
- Mintzberg, H. (1973). *The nature of managerial work*. New York, NY: Harper & Row.
- Mintzberg, H. (1983). *Structure in Fives: Designing Effective Organisations*. New Jersey: Prentice-Hall.
- Mishra, A.K. (1996). Organizational responses to crisis: The centrality of trust. In R. Kramer & T. Tyler (Eds.), *Trust in 21 organizations: Frontiers of theory and research* (pp. 261-287). Thousand Oaks, CA: Sage.
- Mishra, J., & Morissey, M.A. (1990). Trust in employee/employer relationships: A survey of West Michigan managers. *Public Personnel Management, 19*, 443-485.
- Modaff, D.P., DeWine, S., & Butler, J. (2008). *Organisational communication: foundations, challenges, and misunderstandings*. Boston, MA: Pearson Education.
- Mohammed, S., Ferzandi, L., & Hamilton, K. (2010). Metaphor no more: A 15-year review of the team mental model construct. *Journal of Management, 36*(4), 876-910.
- Moran, G. (1966). Dyadic attraction and orientational consensus. *Journal of Personality and Social Psychology, 4*(1), 94-99.
- Morgan, G. (1989). *Creative Organisation Theory*. London: Sage.
- Morgan, G. (1997). *Images of Organisation*. Thousand Oaks, CA: Sage Publications.
- Morgenson, F.P., DeRue, D.S., & Karam, E.P. (2010). Leadership in teams: A functional approach to understanding leadership structures and processes. *Journal of Management, 36*(1), 5-39.
- Moroko, L., & Uncles, M.D. (2008). Characteristics of successful employer brands. *Journal of Brand Management, 16*(3), 160-175.
- Morrison, M. (2000). *Unifying Scientific Theories: Physical Concepts and Mathematical Structures*. Cambridge: Cambridge University Press.
- Morrow, S.L. (2005). Quality and Trustworthiness in Qualitative Research in Counseling Psychology. *Journal of Counseling Psychology, 52*(2), 250-260.
- Morton, I.P. (2002). Targeting generation Y. *Public Relationship Quarterly, 47*(2), 46-48.
- Mourshed, M., Patel, J., & Suder, K. (2014). *Education to Employment: Getting Europe's Youth Into Work*. UK: McKensy Center Government.
- Mouton, J., & Marais, H.C. (1988). *Basic concepts in the methodology of the social sciences*. Pretoria: HSRC Press.
- Moxley, R.S. (1998). Hardships. In C.D. McCauley, R.S. Moxley, & E. Van Velsor (Eds.). *The Center for Creative Leadership handbook of leadership development* (pp. 194-213). San Francisco, CA: Jossey-Bass.
- Muhammed, S. (2012). Graduate employability and transferable skills: A review. *Advances in Natural and Applied Sciences, 6*(6), 882-885.

- Mullen, B., & Cooper, C. (1994). The relation between group cohesiveness and performance: Integration. *Psychological Bulletin*, 115(2), 210-227.
- Mumford, M.D., & Connelly, M.S. (1991). Leaders as creators: Leader performance and problem solving in ill-defined domains. *Leadership Quarterly*, 2, 289-315.
- Mumford, T.V., Campion, M.A., & Morgeson, F.P. (2007). The leadership skills strataplex: Leadership skill requirements across organisational levels. *The Leadership Quarterly*, 18, 154-166.
- Murari, L. (2004). *Google's employee satisfaction*. Retrieved May 22, 2017 from <http://blackmoney.blogspot.com/2008/02/googles-employee-satisfaction-03.html>.
- Muthén, B., & Kaplan, D. (1985). A comparison of some methodologies for the factor analysis of non-normal Likert variables: A note on the size of the model. *British Journal of Mathematical and Statistical Psychology*, 45, 19-30.
- Myburgh, H.M. (2013). *The development and evaluation of a generic individual non-managerial performance measure*. (Published Master's thesis). University of Stellenbosch, Stellenbosch, South Africa.
- Myers, G.E., & Myers, M.T. (1982). *Managing by Communication – An Organisational Approach*. New York, NY: McGraw-Hill.
- Nadler, D.A., & Tushman, M.L. (1980). A model for diagnosing organisation behaviour. *Organisation Dynamics* 9(2), 35-51.
- Nagy, T. (2000). *Ethics in plain English: An illustrative casebook for psychology*. Washington, DC: American Psychological Association.
- Naidoo, R. (2002). *Corporate Governance: An Essential Guide for South African Companies*. South Africa: Double Storey Books.
- Nanus, B. (1992). *Visionary leadership: Creating a compelling sense of direction for your organization*. San Francisco, CA: Jossey-Bass.
- Narayandas, D., & Moldoveanu, M. (2019a). *The Skills Gap and the Near-Fair Problem in Executive Education and Development*. Harvard Business School.
- Naryandas, D., & Moldoveanu (2019b). The future of leadership development. *Harvard Business Review March-April*, 40-48.
- National Committee for Research Ethics in Science and Technology (2008). *Guidelines for Research Ethics in Science and Technology*. Norway: NENT.
- Nelson, D.B., & Quick, J.C. (2011). *Understanding organisational behaviour*. Mason, OH: South-Western Cengage Learning.
- Nelson, W.A., & Donnellan, J. (2009). An executive-driven ethical culture. *Healthcare Executive*, 24(6), 44-46.
- Nemoto, T., & Beglar, D. (2014). *Developing Likert-scale questionnaires*. In N. Sonda & Krause (Eds.), JALT 2013 Conference Proceedings. Tokyo: JALT.



- Neuman, W.L. (2003). *Social Research Methods: Qualitative and Quantitative Approaches*. London: Allyn & Bacon.
- Ng, E.S., Schweitzer, L., & Lyons, S.T. (2010). New Generation, Great Expectations: A Field Study of the Millennial Generation. *Journal of Business Psychology, 25*, 281-292.
- Ng, E.S.W., & Burke, R.J. (2005). Organisation fit and the war for talent: does diversity management make a difference? *The International Journal of Human Resource Management, 16*(7), 1195-1210.
- Nixon, B. (1994). Developing an empowering culture in organisations. *Empowerment in Organisations, 2*(1), 14-24.
- Norman, G. (2010). Likert scales, levels of measurement and the 'laws'. *Advances in Health Sciences Education, 15*, 625-632.
- Norman, G., Avolio, B.J., & Luthans, F. (2010). The impact of positivity on trust in leaders and their perceived effectiveness. *The Leadership Quarterly, 21*, 350-364.
- Northouse, P.G. (2007). *Leadership: Theory and practice*. Thousand Oaks, CA: Sage.
- Nunnally, J.C. (1978). *Psychometric theory*. New York, NY: McGraw-Hill.
- Nunnally, J.C., & Bernstein, I.H. (1994). *Psychometric theory*. New York, NY: McGraw-Hill.
- Nye, J.S. (2009). Smart power. *Leadership Excellence, 26*(2), 18.
- O'Connell, D., Hickerson, K., & Pillutla, A. (2011). Organisational visioning: An Integrative Review. *Group and Organisation Management, 36*, 102-125.
- O'Moore, & Lynch, J. (2007). Leadership, working environment and workplace bullying. *International Journal of Organisation Theory and Behaviour, 10*(1), 95-117.
- O'Neil, J., & Marsick, V.J. (2007). *Understanding action learning*. New York, NY: American Management Association.
- O'Neil, J.W., Harrison, M.M., Cleveland, J., Almeida, D., Stawski, R., & Crouter, A.C. (2009). Work-family climate, organizational commitment, and turnover: Multilevel contagion effects of leaders. *Journal of Vocational Behaviour, 74*, 18-29.
- O'Reilly, C.A., & Chatman, J.A. (1996). Culture as social control: Corporations, cults, and commitment. In L. Cummings & B.L. Staw (Eds.), *Research in Organizational Behaviour* (pp. 157-200). Stamford, CT: JAI Press.
- Obolensky, N. (2014). *Complex Adaptive Leadership*. Farnham: Gower.
- Oehley, A. (2007). *The development and evaluation of a partial talent management competency Model*. (Unpublished Master's thesis). University of Stellenbosch, Stellenbosch, South Africa.
- Oh, K.H. (1974). *Forecasting through hierarchical Delphi*. (Unpublished Doctoral thesis). The Ohio State University, Ohio, USA.
- Olmstead, J.A. (2000). *Executive Leadership: Building world-class organisations*. Houston, TX: Gulf Professional Publishing.

- Orlikowski, W.J. (2002). Knowing in practice: Enacting a collective capability in distributed organizing. *Organization Science*, 13(3), 248-273.
- Osmani, M., Weerakkody, V., Nitham, M.H., Al Esmail, R., Eldabi, T., Kapoor, K., & Irani, Z. (2015). Identifying trends and impact of graduate attributes on employability: a literature review. *Tertiary Education and Management*, 21(4), 367-379.
- Özdem, G. (2011). An analysis of the mission and vision Statements on the strategic plans of higher education institutions. *Educational Sciences: Theory and Practice*, 11(4), 1887-1894.
- Padilla, A., Hogan, R., & Kaiser, R. (2007). The toxic triangle: Destructive leaders, susceptible followers, and conducive environments. *The Leadership Quarterly*, 18(3), 176-194.
- Parry, S.B. (1998). Just what is a competency? (And why should you care?). *Training*, 35, 58-64.
- Parsons, T. (1951). *The Social System*. Glencoe, IL: The Free Press.
- Patton, M.Q. (1990). *Qualitative evaluation and research methods* (2<sup>nd</sup> ed.). Newbury Park; CA: Sage.
- Pauw, K., Bhorat, H., Goga, S., Ncube, Oosthuizen, M., & van der Westhuizen, C. (2006). *Graduate Unemployment in the context of skills shortages in education and training: findings from a firm survey*. Retrieved July 7, 2016 from [http://open.uct.ac.za/bitstream/handle/11427/7345/DPRU\\_WP06-115.pdf?sequence=1](http://open.uct.ac.za/bitstream/handle/11427/7345/DPRU_WP06-115.pdf?sequence=1).
- Pawar, B.S., & Eastman, K.K. (1997). The nature and implications of contextual influences on transformational leadership: A conceptual examination. *Academy of Management Review*, 22(1), 80-109.
- Peers, I. (1996). *Statistical analysis for education and psychology researchers*. Bristol, PA: Falmer Press.
- Pejza, J.P. (1985). *The Catholic school principal: A different kind of leader*. [Paper presentation]. The Annual Meeting of the National Catholic Educational Association, Missouri.
- Pelineseu, E. (2015). The Impact of Human Capital on Economic Growth. *Procedia Economics and Finance*, 22(1), 184-190.
- Pelled, L.H., Eisenhardt, K.M., & Xin, K.R. (1999). Exploring the black box: An analysis of work group diversity, conflict, and performance. *Administrative Science Quarterly*, 44, 1-28.
- Pervin, L.A., Cervone, D., & John, O.P. (2005). *Personality: Theory and Research* (9<sup>th</sup> ed.), California: Wiley
- Peterson, H. (2005). Employee Retention: The secrets behind Wal-Mart's successful hiring policies. *Human Resource Management*, 44(1), 85-88.
- Peterson, R.S. (1999). Can you have too much of a good thing? The Limits of voice for improving satisfaction with leaders. *Personality and Social Psychology Bulletin*, 25, 313-324.
- Peterson, E. Wesley F. (2017). The Role of Population in Economic Growth. *Faculty Publications: Agricultural Economics*. 171, 1-15.

- Petrick, J.A., & Furr, D.S. (1995). *Total Quality in Managing Human Resources*. New York: Lucie.
- Petrou, P., Demerouti, E., & Schaufeli, W.B. (2015). Job crafting in changing organisations: Antecedents and implications for exhaustion and performance. *Journal of Occupational Health Psychology, 20*(4), 470-480.
- Pettigrew, T.F. (1998). Intergroup contact theory. *Annual Review of Psychology, 49*, 65-85.
- Pfeiffer, J. (1968). *New look at education*. Poughkeepsie, NY: Odyssey Press.
- Phillips, J.M., Douthitt, E.A., & Hyland, M.M. (2001). The role of justice in team member satisfaction with the leader and attachment to the team. *Journal of Applied Psychology, 86*, 316-325.
- Pierce, J.L., & Jusilla, I. (2011). *New horizons in management. Psychological ownership and the organisational context: Theory, research evidence, and application*. Northampton, MA: Edward Elgar.
- Pigott, T.D. (2001). A Review of Methods for Missing Data. *Educational Research and Evaluation, 7*(4), 353-383.
- Pillai, J., & Meindl, J.R. (1998). Context and charisma: A 'meso' level examination of the relationship of organic structure, collectivism and crisis to charismatic leadership. *Journal of Management, 24*, 643-671.
- Pimple, K.D. (2002). Six domains of research ethics: A heuristic framework for responsible conduct of research. *Science and Engineering Ethics, 8*, 191-205.
- Pitak-Arnnop, P., Schouman, T., Hervé C., & Bertrand, J.C. (2008). Comment éviter la non-conformité de la recherche biomédicale? Recommandations aux chirurgiens. *Journal De Chirurgie, 145*, 534-541.
- Podsakoff, P.M., MacKenzie, S.B., & Bommer, W.H. (1996). Transformation leader behaviour and substitutes for leadership as determinants of employee satisfaction, commitment and trust, and organisational citizenship behaviours. *Journal of Management, 22*(2), p. 258-298.
- Porter, L.W., & Lawler, E.E. (1968). *Managerial attitudes and performance*. Homewood, IL: Dorsey.
- Porter, L.W., & McLaughlin, G.B. (2006). Leadership and the organisational context: Like the weather? *Leadership Quarterly, 17*, 559-576.
- Porter, M.E., & Kramer, M.R. (2011). Creating Shared Value: How to Reinvent Capitalism – and Unleash a Wave of Innovation and Growth. *Harvard Business Review, February*, 63-70.
- Prahalad, C.K., & Hamel, G. (1990). The core competency of the corporation. *Harvard Business Review, 79-91*.
- Preacher, K.J., & Coffman, D.L. (2006). Computing power and minimum sample size for RMSEA. *Computer software*. Available from <http://quantpsy.org>.
- Premeaux, S.R., & Mondy, R.W. (1993). *Management. Concepts, practices and skills*. Boston, CA: Allyn and Bacon.
- Prensky, M. (2001). Digital natives, digital immigrants. *On the Horizon, 9*(5), p.1-6.

- Prinsloo, J. (2015). *Modification, elaboration and empirical evaluation of the Burger learning potential structural model*. (Published Master's thesis). University of Stellenbosch, Stellenbosch, South Africa.
- Pritchard, R.D. (1992). In M.D. Dunette & L.M. Hough (Eds.), *Handbook of Industrial and Organisational Psychology*, 2 (2<sup>nd</sup> ed.). (pp. 443-471). Palo Alto, CA: Consulting Psychologists Press.
- Purvanova, R.K, Bono, J.E., & Dzieweczynski, J., (2006). Transformational leadership, job characteristics and organisational citizenship performance. *Human Performance*, 19(1), 1-22.
- Quinn, R.E., & Cameron, K.S (1983). Organizational Life Cycles and Shifting Criteria of Effectiveness: Some Preliminary Evidence. *Management Science*, 29(1), 33-51.
- Quinn, R.E., & Rohrbaugh, J. (1983). A spatial model of effectiveness criteria: Towards a competing values approach to organizational analysis. *Management Science*, 29(3), 363-377.
- Rafferty, A.E., & Griffin, M.A. (2004). Dimensions of transformational leadership: Conceptual and empirical extensions. *The Leadership Quarterly*, 15(3), 329 – 354.
- Ramosaj, B., & Berisha, G. (2014). Systems Theory and Systems Approach to Leadership. *Iliria International Review*, 1, 57-73.
- Ratuva, S. (2013). *Politics of preferential development. Trans-global study of affirmative action and ethnic conflict in Fiji, Malaysia and South Africa*. Canberra: ANU E Press.
- Raykov T. (2001). Bias of coefficient alpha for fixed congeneric measures with correlated errors. *Applied Psychological Measurement*, 25, 69-76.
- Raykov, T. (1997a). Estimation of composite reliability for congeneric measures. *Applied Psychological Measurement*, 21, 173-184.
- Raykov, T. (1997b). Scale reliability, Cronbach's coefficient alpha, and violations of essential tau-equivalence with fixed congeneric components. *Multivariate Behavioural Research*, 32, 329-353.
- Reise, S.P. (2012). The rediscovery of bifactor measurement models. *Multivariate behavioral research*, 47(5), 667-696.
- Republic of South Africa (1974). *Health Professions Act*, No. 56 of 1974. Pretoria: Government Printers.
- Republic of South Africa (1998). *Employment Equity Act*. *Government Gazette*, 400 (193700), Cape Town: Government Printers.
- Republic of South Africa (2006). *Ethical Rules of Conduct for Practitioners Registered under the Health Professions Act, 1974*. *Government Gazette* 717 (29079). Cape Town: Government Printers.
- Republic of South Africa (2015). *Strategic Plan 2015/16-2019/20*. RSA: Department of Higher Education and Training.
- Research Methods Knowledge Base. The multitriat-multimethod matrix. Accessed on 12 February 2018 from <http://socialresearchmethods.net/kb/mtmmmat.php>.

- Revans, R. (1982). *The Origins and Growth of Action Learning*. Bromley: Chartwell-Bratt.
- Rhemtulla, M. (2016). Population performance of SEM parcelling strategies under measurement and structural model misspecification. *Psychological Methods, 21*(3), 348-368.
- Rhemtulla, M., Brosseau-Liard, P.E., & Savalei, V. (2012). When can categorical variables be treated as continuous? A comparison of robust continuous and categorical SEM estimation methods under suboptimal conditions. *Psychological Methods, 17*(3), 354-373.
- Riesenmy, K.R. (2008). The moderating role of follower identification in the relationship between leader and follower visionary leadership. *Emerging Leadership Journeys, 1*(2), 62-77.
- Ricketta, M. (2008). The casual relation between job attitudes and performance: A Meta-analysis of panel studies. *Journal of Applied Psychology, 93*(3), 472-481.
- Robbins, S.P., DeCenzo, D.A. (2008). *Fundamentals of Management: Essential Concepts and Applications*. Englewood Cliffs, NJ: Pearson Prentice Hall.
- Robbins, S.P., Odendaal, A., & Roodt, G. (2003). *Organisational Behaviour: Global and Southern African perspectives*. Cape Town: Pearson.
- Robbins, S.P., & Sanghi, S. (2007). *Organizational Behaviour*. New Delhi: Pearson Education.
- Roby, T.B. (1961). The executive function in small groups. In B. Bass & L. Petruccio (Eds.), *Leadership and interpersonal behaviour* (pp. 118-136). New York, NY: Holt, Reinhardt, and Winston.
- Roe, R.A. (1999). Work performance: A multiple regulation perspective. In C.L. Cooper, & I.T. Robertson (Eds.), *International review of industrial and organisational psychology, 14* (pp. 231-335) Chichester: Wiley.
- Rogers, C.R. (1961). *On becoming a person*. Boston, CA: Houghton Mifflin.
- Rogers, E.M., & Rogers, A.R. (1976). *Communication in Organisations*. New York, NY: The Free Press.
- Rose, S.A., Markman, B., & Sawilowsky, S. (2017). Limitations in the systematic analysis of structural equation model fit indices. *Journal of Modern Applied Statistical Methods, 16*(1), 69-85.
- Rosenthal, R. (1994). Science and Ethics in conducting, analysing and reporting psychological research. *Psychological Science, 5*(3), 127-134.
- Ross, R.S., & Ross, J.R. (1989). *Small Groups in Organizational Settings*. Englewood Cliff, N.J: Prentice Hall.
- Rossouw, D.M. (2001). Schema, promise and mutuality: The building blocks of the psychological contract. *Journal of Occupational and Organisational Psychology, 74*, 511-541.
- Rothaermel, F.T. (2013). *Strategic Management: Concepts and cases*. New York, NY: McGraw Hill
- Rotundo, M., & Sackett, P.R. (2002). The relative importance of task, citizenship, and counterproductive performance to global ratings of job performance. A policy-capturing approach. *Journal of Applied Psychology, 87*(1), 66-80.

- Roux, A. (2015). *The National Development Plan (NDP): Resolving South Africa's structural economic impediments to achieve a higher growth trajectory*. [Paper presentation]. The NDP Civil Society Dialogue, Stellenbosch.
- Rozman, R., & Kovač, J. (2015). Individual and organisational creativity and innovation: Their management. *Dynamic Relationships Management Journal*, 4(2), 39-50.
- Rubin, D. (1996). Multiple imputation 18+ years. *Journal of American Statistical Association*, 91(434), 473-489.
- Rönkkö, M., & Ylitalo, J. (2011). PLS marker variable approach to diagnosing and controlling for method variance. [Paper presentation]. International Conference on information Systems, Shanghai.
- Sadri, G. (2012). Emotional intelligence and leadership development. *Public Personnel Management*, 41, 535 – 548.
- SAGEA (2014). *The SAGEA Employer Survey 2014*. London: High Flyers Research Ltd.
- SAGRA (2012). *The SAGRA Employer Survey 2012*. London: High Flyers Research Ltd.
- Saif, S.K., Nawaz, A., Jan, F.A., & Khan, M.I. (2012). Synthesizing the theories of job satisfaction across the cultural/attitudinal dimensions. *International Journal of Contingency Research & Business*, 3(9), 1382-1396.
- Salas, E., & Sims, E., & Burke, C.S (2005). Is there a Big Five in teamwork? *Small Group Research*, 36(5), 555-599.
- Sánchez, J.C., & Yurrebaso, A. (2009). Group cohesion: Relationships with work team culture. *Psicothema*, 21(1), 97-104.
- Sandberg, J. (2000). Understanding human competence at work: an interpretative approach. *The Academy of Management Journal*, 43(1), 9-25.
- Sanders, T.J., & Davey, K.S. (2011). Out of the leadership theory jungle: a proposed meta-model of strategic leadership. *Proceedings of the Academy of Strategic Management*, 10(1): 41-46.
- Saner, L.D., Bolstad, C.A., Cuevas, H.M., & Gonzalez, C. (2009). Measuring and predicting shared situation awareness in teams. *Journal of Cognitive Engineering and Decision Making*, 3(3), 280-308.
- Sankar, Y. (2003). Designing the learning organisation as an information-processing system: some design principles from the systems paradigm and cybernetics. *International Journal of Organisation and Theory & Behaviour*, 6(4), 501-521.
- Sankowski, D. (1995). The charismatic leader as narcissist: Understanding the abuse of power. *Organizational Dynamics*, 23(4), 57-71.
- Sarason, S.B., & Lorentz, E.M. (1998). *Crossing Boundaries: Collaboration, Coordination, and the Redefinition of Resources*. San Francisco: Jossey-Bass.
- Sarros, J.C. (1992). What leaders say they do: An Australian example. *Leader Organisational Development Journal*, 13(5), 21-27.
- Sashkin, M., & Sashkin, M.G. (2003). *Leadership that matters*. San Francisco, CA: Berrett-Koehler.

- Satorra, A., & Bentler, P.M. (1994). Corrections to test statistics and standard errors in covariance structure analysis. In C.C. Clogg & A. von Eye (Eds.), *Latent Variables Analysis: Applications to Developmental Research* (pp. 399-419). Thousand Oaks, CA: Sage.
- Sawyer, O.O. (1993) Environmental uncertainty and environmental activities of Nigerian manufacturing executives: a comparative analysis. *Strategic Management Journal*, 14(4), 287-299.
- Schaufeli, W., & Taris, T. (2015). Individual well-being and performance at work. A conceptual and theoretical overview. In R. Peccei & M van Veldhoven (Eds.), *Well-being and performance at work: current issues in work and organisational psychology* (pp. 15-34). Oxford, England: Psychology Press.
- Schaufeli, W.B., & Harris T.W. (2014). Critical review of the job demands-resources model: implications for improving work and health. In G.F. Bauer & O. Hämmig (Eds.), *Bridging occupational, organisational and public health: A transdisciplinary approach*. New York, NY: Springer.
- Schaufeli, W.B., Salanova, M., Gonzalez-Roma, V., & Bakker, A.B. (2002). The measurement of engagement and burnout: a two sample confirmatory factor analytic approach. *Journal of Happiness Studies*, 3, 71-92.
- Schein, E. H. (1985). *Organisational Culture and Leadership*. San Francisco, CA: Jossey-Bass.
- Schein, E. H. (1992). *Organizational Culture and Leadership*. San Francisco, CA: Jossey-Bass.
- Schein, E.H. (2004). *Organisational Culture and Leadership*. San Francisco, CA: Jossey-Bass.
- Schermelleh-Engel, K., Moosbrugger, H., & Müller, H. (2003). Evaluating the fit of structural equation models: Tests of significance and descriptive goodness-of-fit measures. *Methods of Psychological Research Online*, 8, 23–74.
- Schermerhorn, J. (2006). *Management: Personal Management Edition*. Indianapolis, IN: Wiley & Sons.
- Schmitt, N.W., & Klimoski, R.J. (1991). *Research methods in human resources management*. Cincinnati: South-Western.
- Scholarios, D., Lockyer, D., & Johnson, H. (2003). Anticipatory socialisation: the effect of recruitment and selection experiences on career expectations. *Career Development International*, 8(4), 182-197.
- Schreiber, J.B., Nora, A., Stage, F.K., King, J., & Barlow, E.A. (2006). Reporting structural equation modelling and confirmatory factor analysis results: A review. *The Journal of Educational Research*, 99(6), 323-337.
- Schriesheim, C.A, Powers, K.J., Scandura, T., Gardiner, C.C., & Lankau, K.J. (1993). Improving construct measurement in management research: Comments and a quantitative approach for assessing the theoretical content adequacy of paper-and-pencil survey-type instruments. *Journal of Management*, 19, 385-417.
- Schumacker, R.E., & Lomax, R.G. (2010). *A beginner's guide to structural equation modelling*. New York, NY: Routledge.

- Searle, B.J., & Lee, L. (2015). Proactive coping as a personal resource in the expanded Job Demands-Resources Model. *International Journal of Stress Management*, 22(1), 46-69.
- Seashore, S.E., & Yuchtman, E. (1967). Factorial Analysis of Organisational Performance. *Administrative Science Quarterly*, 12, 377-395.
- Seers, A. (2004). Leadership and flexible organisational structures. In G.B. Graen (Ed.), *New frontiers of leadership, LMX Leadership: The Series* (pp. 1-31). Greenwich, CT: Information Age Publishing.
- Seers, A., Petty, M.N., & Cashman, J.F. (1995). Team-member exchange under team and traditional management. *Group & Organisation Management*, 20, 18-38.
- Seland, J.M. (2017). *The development and empirical testing of a revised Performance Index*. (Unpublished Master's thesis). University of Stellenbosch, Stellenbosch, South Africa.
- Sen, A. (1985a) *Commodities and Capabilities*. Amsterdam: North Holland.
- Sen, A. (1985b) Well-being, agency and freedom. *The Journal of Philosophy* LXXXII (4): 169-221.
- Selznick, P. (1957). *Leadership in administration: A sociological interpretation*. New York, NY: Harper & Row.
- Sendjaya, S., Sarros, J.C., & Santora, J.C. (2008). Defining and measuring servant leadership behaviour in organisations. *Journal of Management Studies*, 45(2), 402-424.
- Senge, P. (2006). *The fifth discipline: The art and practice of the learning organisation*. New York, NY: Doubleday.
- Seth, J.N, Sisodia, R.S., & Wolfe, D.B. (2007). *Firms of Endearment: The Pursuit of Purpose and Profit*. Upper Saddle River, NJ: Wharton School Publishing.
- Seyranian, V., Bligh, M.C. (2008). Presidential charismatic leadership: Exploring the rhetoric of social change. *The Leadership Quarterly*, 19, 54-76.
- Shafritz, J.M., Ott, J.S., & Yang, S.K. (2015). *Classics of organisation theory*. Boston, MA: Cengage Learning.
- Shamir, B. (1991). The charismatic relationship: Alternative explanations and predictions. *Leadership Quarterly*, 2, 81-104.
- Shamir, B., House, R.T., & Arthur, M.B. (1993). The motivational effects of charismatic leadership: A self concept based theory. *Organisation Science*, 4(4), 577-594.
- Sharma, M., & Mills, D. (2005). Learning Outcomes and Curriculum Development in Physics. A Report on Tertiary Physics Learning and Teaching in Australia. Commissioned by the Australian Universities Teaching Committee. Retrived March 2, 2008 From <http://www.physics.usyd.edu.au/super/AUTC/autc/>.
- Sharma, S., Mukherjee, S., Kumar, A., & Dillon, W.R. (2005). A simulation study to investigate the use of cut-off values for assessing model fit in covariance structure models. *Journal of Business Research*, 58(1), 935-943.
- Sharma, V., & Shirsath, M. (2014). Training – A motivational tool. *Journal of Business and Management*, 16(3), 27-35.



- Shaw, M.E. and Shaw, L.M. (1962). Some effects of socio-metric grouping upon learning in a second grade classroom. *Journal of Social Psychology*, 57(2), 453-458.
- Shea, G. (1984). *Building trust in the workplace*. New York, NY: McGraw-Hill.
- Sheahan, P. (2005). *Generation Y: thriving and surviving with Generation Y at work*. Prahran, Victoria: Hardie Grant.
- Sheng, Y., & Sheng, Z. (2012). Is coefficient alpha robust to non-normal data? *Frontiers in Psychology*, 3, 34.
- Shih, W., & Allen, M. (2007). Working with generation Y: adopting and adapting to cultural learning and change. *Library Management*, 28(1/2), 89-100.
- Shippman, J.S., Ash, R.A., Battista, M.A., Carr, L., Eyde, L.D., Hesketh, B., Kehoe, J., Pearlman, K., Prien, E.P., & Sanchez, J.I. (2000). The practice of competency modelling. *Personnel Psychology*, 53, 703-740.
- Shokane, MS., Stanz, K.J., & Slabbert, J.A. (2004). Description of Leadership in South Africa: Organisational Context Perspective. *South African Journal of Human Resource Management*, 2(3), 1-6.
- Shonhiwa, S (2006). *The Effective Cross-Cultural Manager: A Guide for Business Leaders in Africa*. Cape Town: Zebra.
- Shrestha, L., Prince, E., Baker, C., & Salas, F.L. (1995). Situation awareness in team performance: Implications for measurement and training. *Human Factors* 37(2), 123-136.
- Shuck, B., & Herd, A.M. (2012). Employee engagement and leadership: exploring the convergence of two frameworks and implications for leadership development in HRD. *Human Resources Management Review*, 11(3), 156-181.
- Siegrist, J. (1996). Adverse health effects of high effort-low reward conditions. *Journal of Occupational Health Psychology*, 1, 27-41.
- Sijtsma K. (2009). On the use, the misuse, and the very limited usefulness of Cronbach's alpha. *Psychometrika* 74, 107-120.
- Simms, J. (2003). Corporate Irresponsibility. *Directorship*. August, 20.
- Simonet, D.V., & Tett, R.P. (2013). Five perspectives on the leadership-management relationship: A competency-based evaluation and integration. *Journal of Leadership and Organisational Studies*, 20(2), 199-213.
- Simons, T.L., & Peterson, R.S. (2000). Task conflict and relationship conflict in top management work groups and teams: The pivotal role of intragroup trust. *Journal of Applied Psychology*, 85, 102-111.
- Sims, H.P., & Manz, C.C. (1984). Searching for the 'Unleader': Organisational member views on leading self-managed groups. *Human Relations*, 37, 409-424.
- Sinetar, M. (1981). Mergers, morale and productivity. *Personnel Journal*, 60, 863-867.
- Slaper, T.F., & Hall, T.J. (2011). The tripple bottom line: What is it and how does it work? *Indiana Business Review*, 86(1), 1-8.

- Slaski, M., & Cartwright, S. (2003). Emotional intelligence training and its implications for stress, health and performance. *Stress and Health, 19*(4), 233-239.
- Sloane, P.J. "Much ado about nothing? What does the over-education literature really tell us?" MPI for human development conference, 2002, Berlin, Germany. Keynote Address.
- Smith, C.A., Organ, D.W., & Near, J.P. (1983). Organizational citizenship behaviour: Its nature and antecedents. *Journal of Applied Psychology, 68*, 655-663.
- Smolek, J., Hoffman, D., & Moran, L. (1999). Organizing teams for success. In E. Sundstrom (Ed.), *Supporting work team effectiveness* (pp. 24-62). San Francisco, CA: Jossey-Bass.
- Snow, C.C., & Hrebiniak, L.G. (1980). Strategy, distinctive competence, and organisational performance. *Administrative Science Quarterly, 25*, 317-336.
- Sobel, M. (1996). An introduction to causal inference. *Sociological Methods & Research, 24*, 353-379.
- Sonnenberg, F.K. (1994). 'Trust Me . . . Trust Me Not.' *Journal of Business Strategy 15*(1), 14-16.
- Sonnentag, S., Volmer, J., & Spychala, A. (2008). Job performance. In J. Barling & Cooper, C. (Eds.), *The SAGE Handbook of Organisational Behaviour: Volume 1 – Micro Approaches* (pp. 427-447). London, England: Sage Publications.
- Soyer, K., Ozgit, H., & Rjoub, H. (2020). Applying an Evolutionary Growth Theory for Sustainable Economic Development: The Effect of International Students as Tourists. *Sustainability 12*(1), 418.
- Spangenberg, H., Theron, C.C., & Dunbar, H.H. (2011). A cross-validation study of the Performance Index. *Management Dynamics, 20*(3), 2-24.
- Spangenberg, H.H., & Theron, C.C. (2013). A critical review of the Burke-Litwin model of leadership, change and performance. *Management Dynamics, 22*(2), 29-48.
- Spector, P.E. (1994). Using self-reported questionnaires in OB research: a comment on the use of a controversial method. *Journal of Organisational Behaviour, 15*(5), 385-392.
- Spreitzer, G.M. (1995). Psychological empowerment in the workplace: Dimensions, measurement, and validation. *Academy of Management Journal, 35*, 1442-1465.
- Stahl, G.K., Björkman, I., Farndale, E., Morris, S., Paauwe, J., Stiles, P., Trevor, J., & Wright, P. (2007). *Global talent management: how leading multinationals build and sustain their talent pipeline*. [Paper presentation]. INSEAD, France.
- STATS SA, Statistics South Africa. (2017, June 6). *The South African economy shrinks by 0,7%*. Retrieved July 20, 2017 from <http://www.statssa.gov.za/?p=9989>.
- Steenkamp, J., & van Trijp, H. (1991). The use of LISREL in validating marketing constructs. *International Journal of Research in Marketing, 8*, 283-299.
- Steffens, N.K., Haslam, S.A., Reicher, S.D., Platow, M.J., Franssen, K., Yang, J., Ryan, M.K., Jetten, J., Peters, K., & Boen, F. (2014). Leadership as social identity management: Introducing the Identity Leadership Inventory (ILI) to assess and validate a four-dimensional model. *Leadership Quarterly, 25*, 1001-1024.

- Steiger, J.H. (2007). Understanding the limitations of global fit assessment in structural equation modelling. *Personality and Individual Differences*, 42(5), 893-898.
- Steiner, G.A. (1971). *Business and Society*. New York, NY: Random House.
- Steiner, I.D. (1972). *Group process and productivity*. New York, NY: Academic.
- Stellenbosch University, Division for Research Development. (2013). *Policy for responsible research conduct at Stellenbosch University*. Cape Town: Stellenbosch University.
- Stellenbosch University, Innovus. (2010). *Policy in respect of the commercial exploitation of intellectual property*. Cape Town: Stellenbosch University.
- Sternberg, R.J. (2007). A systems model of leadership: WICS. *American Psychologist*, 62, 34-42.
- Stevens, G.W. (2012). A critical review of the science and practice of competency modelling. *Human Resource Development Review*, 12(1), 86-107.
- Stogdill, R. (1974). *Handbook of leadership: A survey of theory and research*. New York, NY: Free Press.
- Stogdill, R.M. (1948). Personal factors associated with leadership; a survey of the literature. *Journal of Psychology: Interdisciplinary and Applied*, 25, 35-71.
- Straus, M.A., & McGrath, J.E. (1994). Does the medium matter? The interaction of task type and technology on group performance and member reactions. *Journal of Applied Psychology*, 79(1), 87-97.
- Styhre, A. (2002). Non-linear change in organisations: organisation change management informed by complexity theory. *Leadership & Organisation Development Journal*, 23(6), 343-351.
- Subramony, M. (2009). A meta-analytic investigation of the relationship between HRM bundles and firm performance. *Human Resource Management*, 48, 745-768.
- Subramony, M., Segers, J., Chadwick, C., & Shyamsunder, A. (2018). Leadership development practice bundles and organizational performance: The mediating role of human capital and social capital. *Journal of Business Research*, 83, 120-129
- Sullivan, J. (2002). *Crafting a lofty employment brand: a costly proposition*. Retrieved July 7, 2016 from <http://www.ere.net/2002/11/25/crafting-a-lofty-employment-brand-a-costlyproposition>.
- Summers, S. (1991). Selecting the sample for a research study. *Journal of Post Anaesthetic Nursing*, 6(5), 355-258.
- Sutton, H. (1988). *Competitive Intelligence*. New York, NY: The Conference Board.
- Swales, J.M., & Rogers, P. (1995). *Discourse and the projection of corporate culture: the mission statement*. *Discourse & Society*. London, Thousand Oaks CA: Sage.
- Swanson, R.A., & Torraco, R.J. (1995). The strategic roles of human resource development. *Human Resource Planning*, 18(4), 10-21.
- Sweeney, D. (2013). Statistics: The Normal Distribution. *Encyclopædia Britannica*.

- Tabachnick, B.G., & Fidell, L.S. (2007). *Using Multivariate Statistics* (5<sup>th</sup> ed.). New York, NY: Allyn and Bacon.
- Tannenbaum, S.L., Smith-Jentsch, K.A., & Behson, S.J. (1998). Training team leaders to facilitate team learning and performance. In J.A. Cannon-Bowers & E. Salas (Eds.), *Making decisions under stress: implications for individual and team training* (pp. 247-270). Washington, DC: American Psychological Association.
- Tatum, B.C., & Nebecker, D.M. (2002). Understanding organisational processes and performance. In R.L. Lowman (Ed.), *Handbook of organisational consulting psychology* (pp. 668-691). San Francisco, CA: Jossey-Bass.
- Taylor, T.R. (1989). *International developments in psychological assessment*. [Paper presentation]. Congress on Psychometrics for Psychologists, Megawatt Park.
- Taylor, T.R. (1992). *Beyond competence: measuring potential in a cross-cultural situation fairly: potential in psychometrics: Part two*. [Paper presentation]. Congress on Psychometrics for Psychologists, Megawatt Park.
- Taylor, T.R. (1997). *Administrator's Manual for APIL-B Battery*. Auckland Park: AProLAB.
- Taylor, T.R. (1994). A review of three approaches to cognitive assessment, and proposed integrated approach based on a unifying theoretical framework. *South African Journal of Psychology*, 24(4), 184-193.
- Teece, D.J., Pisano, G., Shuen, A. (1997). Dynamic capabilities and strategic management. *Strategic Management Journal*, 18(7), 509-533.
- Tepper, B.J. (2000). Consequences of abusive supervision. *Academy of Management Journal*, 43, 178-190.
- Terjesen, S., & Vinnicombe, S., & Freeman, C. (2007). Attracting generation Y: Organisational attributes, likelihood to apply and sex differences. *Career Development International*, 12(6), 504-522.
- Tett, R.P., & Meyer, J.P. (1993). Job satisfaction, organisational commitment, turnover intention: Path analyses on meta-analytic findings. *Personnel Psychology*, 46, 259-293.
- Thakore, D. (2013). Conflict and conflict management. *Journal of Business and Management*, 8(6), 7-16.
- The British Psychological Society (2010). *Code of Human Research Ethics*. UK: BPS Press.
- The Department of Trade and Industry (2016). *Industrial Policy Action Plan*. Pretoria: The DTI.
- The European Commission, INNOREGIO Project. (2000). *Employee involvement*. Crete: Greece.
- The Health Professions Council of South Africa (1974). *The Ethical Rules of Conduct*. Pretoria: HPCSA.
- Theron, C.C. (2007). Confessions, scapegoats and flying pigs: Psychometric testing and the law. *SA Journal of Industrial Psychology*, 33(1), 102-117.

- Theron, C.C., & Spangenberg, H.H. (2005). Towards a comprehensive leadership unit performance structural model: The development of second-order factors for the leadership behaviour inventory. *Management Dynamics*, 14(1), 35-50.
- Theron, C.C., & Spangenberg, H.H. (2016). An assessment of the structural invariance of the Performance Index structural model. *Journal of the South African Institute for Management Scientists*, 25(2), 17-40.
- Thompson, J.D. (1967). *Organisations in Action*. New York, NY: McGraw-Hill.
- Thompson, L., & Fine, G.A. (1999). Socially shared cognition, affect, and behavior: A review and integration. *Personality and Social Psychology Review*, 3(4), 278-302.
- Thordsen, M. L., & Klein, G.A. (1989). *Cognitive processes of the team mind*. [Paper presentation]. IEEE International Conference on Systems, Man, and Cybernetics, Cambridge.
- Timmers, G.H. (1996). *Waves of change: a perspective for the year 2000*. (Published Master's thesis). RAU, Johannesburg, South Africa.
- Tolentino, R. (2013). Organisational commitment and job performance of the academic and administrative personnel. *International Journal of Information technology and Business Management*, 15(1), 51-59.
- Tong, Y.K., & Arvey, R.D. (2015). Managing complexity via the Competing Values Framework. *Journal of Management Development*, 34(6), 653-673.
- Toor, S.R., & Ofori, G. (2008). Leadership vs. Management: How they are different and why! *Journal of Leadership and Management in Engineering*, 8(2), 61-71.
- Trading Economics. (2017). *South Africa Unemployment Rate*. Retrieved March 5, 2017 from: <http://www.tradingeconomics.com/south-africa/unemployment-rate>.
- Tran, Q., & Tian, Y. (2013). Organisational structure: Influencing factors and impact on firm. *American Journal of Industrial and Business Management*, 3, 229-236.
- Tredoux, C.T., & Durheim, K. (2002). *Numbers, hypotheses and conclusions: A course in statistics for the social sciences*. Cape Town: UCT Press.
- Truxillo, D.M., Bauer, T.N., & Erdogan, B. (2016). *Psychology and Work: Perspectives on Industrial and Organisational Psychology*. New York, NY: Routledge.
- Tshilongamulenzhe, C. M. (2015). *Enunciating the skills development challenge facing South Africa*. University of South Africa: Department of Human Resource Management.
- Tubre, T., Arthur, W.J., & Bennett, W.J. (2006). General models of job performance: theory and practice. In W. Bennett, C.E. Lance, & D.J. Woehr (Eds.), *Performance Measurement: Current Perspectives and Future Challenges* (pp. 175-203). Mahwah, NJ: Lawrence Erlbaum Associates.
- Tuckman, B.W., & Jensen, M.A.C. (1977). Stages of small group development revisited. *Group and Organization Studies*, 2(4), 419-427.
- Tushman, M.L. (1977). Special Boundary Roles in the Innovation Process. *Administrative Science Quarterly*, 22(4), 587-606.

- Tushman, M.L., & Scanlan, T.L. (1981). Boundary spanning individuals: Their role in information transfer and their antecedents. *Academy of Management Journal*, 24(2), 289-305.
- Tuzzolino, F., & Armandi, B. (1982). Organisational design, slack, and the life cycle. *Academy of Management proceedings*, 1, 261-264.
- Twenge, J. (2010). A review of the empirical evidence on generational differences in work attitudes. *Journal of Business Psychology*, 25(2), 201-210.
- Tyler, E. (1971). *Primitive culture*. London: Murray.
- Tziner, A. (1982). Differential effects of group cohesiveness types: a clarifying overview. *Social Behaviour and Personality*, 10, 227 – 239.
- Ulrich, D., & Zenger, J., & Smallwood, N. (1999). *Results-based leadership*. Boston, MA: Harvard Business School Press.
- Ulrich, D., Smallwood, N., & Sweetman, K. (2008). *The Leadership Code: Five rules to lead by*. Boston, MA: Harvard Business Press.
- Van Alphen, A, Halfens, R., Hasman, A., & Imbos, T. (1994). Likert or Rasch? Nothing is more applicable than good theory. *Journal of Applied Nursing*, 20, 196-201.
- Van den Eynden, V., Corti, L., Woollard, M., Bishop, L., & Hortin, L. (2011). *Managing and Sharing Data: Best Practice for Researchers*. Colchester: UK Data Archive.
- van der Klink, J.J.L., Bültmann, U., Budorf, A., Schaufeli, W.B., Zijlstra, F.R.H., Abma, F., I., Brouwer, S, van der Wilt, G.J. (2016). Sustainable employability – definition, conceptualisation, and implications: A perspective based on the capability approach. *Scandinavian Journal of Work and Environmental Health*, 42(1), p. 71-79.
- Van Heerden, S. (2013). *Elaboration and empirical evaluation of the De Goede learning potential structural model*. (Unpublished master' thesis). University of Stellenbosch, Stellenbosch, South Africa.
- Van Rooyen, E.J., & Whittle, C. (2011). Talent management as a key imperative for leadership development. *Journal of Public Administration*, 46(3), 1039-1054.
- van Uden, J. (2004). *Organisation & Complexity: Using Complexity Science to Theorise Organisational Aliveness*. Boca Raton, Florida: Dissertation.com.
- Van Velsor, E., & McCauly, C.E. (2003). *Handbook of Leadership Development* (2<sup>nd</sup> ed.). San Francisco, CA: John Wiley & Sons.
- Van Velsor, E., McCauly, C.D., & Ruderman, M.N. (2010). *Handbook of Leadership Development* (3<sup>rd</sup> ed.). San Francisco, CA: John Wiley & Sons.
- Van Vugt, M. (2006). Evolutionary Origins of Leadership and Followership. *Personality and Social Psychology Review*, 10(4), 354-371.
- Van Wyk Louw, N.P. (1958). *Liberal Nationalism: Thoughts on the nationalism, liberalism and tradition for South Africans with a cultural after effect*. Cape Town: National Book Trade.
- Varela, O.E., & Landis, R.S. (2010). A general structure of job performance: Evidence from two studies. *Journal of Business and Psychology*, 25, 625-638.

- Veldsman, T.H. (2002). *Into the people effectiveness arena – Navigating between chaos and order*. South Africa: Knowledge Resources.
- Verna, (2010). The mission statement is a strategic tool: when used properly. *Management Decision*, 40(5), 448-455.
- Victoroff, K.Z., & Hogan, S. (2006). Students' perceptions of effective learning experiences in dental school: a qualitative study using a critical incident technique. *Journal of Dental Education*, 2, 124-132.
- Viswesvaran, C., & Ones, D.S. (2000). Perspectives on models of job performance. *International Journal of Selection and Assessment*, 8, 216-226.
- Viviers, W., Muller, M., & Du Toit, A. (2005). Competitive intelligence: An instrument to enhance South Africa's competitiveness. *South African Journal of Economic and Management Sciences*, 8(2), 246-254.
- Vollman, J., & Winau, R. (2013). Informed consent in human experimentation before the Nuremberg code. *British Medical Journal*, 313, 1445-1447.
- Von Bertalanffy, L. (1950). The Theory of Open Systems in Physics and Biology. *Science*, 3, 23-29.
- von Treuer, K., & McLeod, J. (2013). Towards a cohesive theory of cohesion. *International Journal of Business and Social Research*, 3(12), 1-11.
- Vroom, G. (2006). Organizational design and the intensity of rivalry. *Management Science*, 52(11), 1689-1702.
- Wageman, R. (1995). Interdependence and Group Effectiveness. *Administrative Science Quarterly*, 40, 145-180.
- Wageman, R., Hackman, J.R., & Lehman, E. (2005). Team diagnostic survey development of an instrument. *Journal of Applied Behavioural Science*, 41, 373-398.
- Wall, S., J., & Wall, S.R. (1995). *The New Strategists: Creating Leaders at All Levels*. New York, NY: The Free Press.
- Wang, X.H., & Howell, J.M. (2010). Exploring the dual-level effects of transformational leadership on followers. *Journal of Applied Psychology*, 95(6), 1134-1144.
- Warr, M. (1998). Life course transitions and distance from crime. *Criminology*, 36, 183-218.
- Weinberg, G.M. (2001). *An Introduction to General Systems Thinking*. Dorset House.
- Weiss, H.M., & Cropanzano, R. (1996). Affective events theory: A theoretical discussion of the structure, causes and consequences of the affective experiences at work. In L.L. Cummings & B.M. Staw (Eds.), *Research in organisational behaviour: An annual series of analytical essays and critical review*, 18 (pp. 1-74). Greenwich, CT: JAI Press.
- Weiss, M.J. (2003). To be about to be. *American Demographics*, 25(7), 28-36.
- Welfel, E.R. (2010). *Ethics in counselling and psychotherapy: Standards, research and emerging issues*. Pacific Grove, CA: Brooks.

- Werner, A., Du Plessis, A., Ngalo, O., Poisat, P., Sono, T., van Hoek, L., Botha, C. (2011). *Human Resources Management*. South Africa: Oxford University Press.
- Werther, W.B., & Davis, K. (1982). *Personnel Management and Human Resources*. New York, NY: McGraw-Hill.
- West, M.A., & Markiewicz, L. (2004). *Building Team-Based Working. A practical guide to organizational transformation*. Oxford: British Psychological Society.
- Westen, D., & Rosenthal, R. (2003). Construct validity: two simple measures. *Journal of Personality and Social Psychology*, *84*(3), 608-618.
- Westland, C.W. (2015). *Structural equation models: From paths to networks: Studies in systems, decision and control*. Cham: Springer.
- Wheaton, B., Muthen, B., Alwin, D.F., & Summers, G. (1977). Assessing Reliability and Stability in Panel Models. *Sociological Methodology*, *8*(1), 84-136.
- Wheelen, T.L., Hunger, J.D., Hoffman, A.N., & Bamford, C.E. (2015). *Concepts in strategic management and business policy: Globalisation, innovation, and sustainability*. Upper Saddle River, NJ: Pearson.
- Widaman, K.F. (1985). Hierarchically nested covariance structure models for multitrait-multimethod data. *Applied Psychological Measurement*, *9*, 1-26.
- Widhiarso, W. & Ravand, H. (2014). Estimating reliability coefficient for multidimensional measures: A pedagogical illustration. *Review of Psychology*, *21*(2), 111-121.
- Williams, C. (2007). Research methods. *Journal of Business & Economic Research*, *5*(3), 65-72.
- Williams, L.J., & O'Boyle, E.H. (2008). Measurement models for linking latent variables and indicators: a review of human resource management research using parcels. *Human Resource Management Review*, *18*, 233-242.
- Wilson, J.A., & Elman, N.S. (1990). Organizational benefits of mentoring. *Academy of Management Review*, *4*(4), 88-94.
- Wilson, R.A., & Broscoe, G. (2004). The impact of human capital on economic growth: a review. *Third report on vocational training research in Europe: a background report*. Luxembourg: Office for the Official Publications of the European Communities.
- World Economic Forum's Global Competitiveness Report (2019) (retrieved August 1, 2020 from [http://www3.weforum.org/docs/WEF\\_TheGlobalCompetitivenessReport2019.pdf](http://www3.weforum.org/docs/WEF_TheGlobalCompetitivenessReport2019.pdf))
- Wothke, W., & Browne, M.W. (1990). The direct product model for the MTMM matrix parameterized as a second-order factor analysis model. *Psychometrika*, *55*(2), 255-262.
- Wright, N.S., & Drewery, G.P. (2006). Forming cohesion in culturally heterogeneous teams. Differences in Japanese, Pacific Islander and Anglo experiences. *Cross Cultural Management*, *13*(1), 43-53.
- Wright, T.A., Cropanzano, R. (2000). Psychological well-being and job satisfaction as predictors of job performance. *Journal of Occupational Health Psychology*, *5*(1), 84-94.



- Wrzesniewski, A., & Dutton, J.E. (2001). Crafting a job: Revisioning employees as active crafters of their work. *Academy of Management Review*, 25, 179-201.
- Wu, N., & Yu, T. (2009). A review of study on the competing values framework. *International Journal of Business and Management*, 4(7), 37-42.
- Xenikou, A., & Simosi, M. (2006). Organisational culture and transformational leadership as predictors of business unit performance. *Journal of Managerial Psychology*, 21(6), 566-579.
- Yan, Q., Qin, G., Zhang, M., & Xiao, B. (2019). Research on real purchasing behaviour: Analysis of electric cars in Beijing based on Structural Equation Modelling and Multinomial Logit Model. *Sustainability*, 11, 5870.
- Yang, J., & Mossholder, K.W. (2004). Decoupling task and relationship conflict: The role of intragroup emotional processing. *Journal of Organizational Behaviour*, 25, 589-605.
- Yemm, G. (2008). Influencing others – a key skill for all. *Management Services*, 52(2), 21- 24.
- Yrle, A.C., Hartman, S.J., & Payne, D.M. (2005). Generation X: Acceptance of others and teamwork implications. *Team Performance Management*, 11(516), 188-199.
- Yukelson, D. (1997). Principles of effective team building interventions in sport: A direct services approach at Penn State University. *Journal of Applied Psychology*, 9, 73-96.
- Yukl, G. (2002). *Leadership in organisations*. Upper Saddle River, NJ: Prentice Hall.
- Yukl, G. (2009). Leadership and organisational learning: An evaluative essay. *Leadership Quarterly*, 20, 49-53.
- Yukl, G., & Lepsinger, R. (2004). *Flexible leadership: creating value by balancing multiple challenges and choices*. San Francisco, CA: Jossey Bass/Wiley.
- Zacarro, S.J., & DiRosa, G.A. (2012). *The processes of team staffing: A review of relevant studies*. *International Review of Industrial and Organizational Psychology*. Hoboken, NJ: John Wiley & Sons.
- Zaccaro, S.J., & Lowe, C.A. (1988). Cohesiveness and performance on an additive task: Evidence for multidimensionality. *The Journal of Social Psychology*, 128(4), 547-558.
- Zaccaro, S.J., Blair, V., Peterson, C., & Zazanis, M. (1995). Collective efficacy. In J.E. Maddux (Ed.), *The Plenum series in social/clinical psychology. Self-efficacy, adaptation, and adjustment: Theory, research, and application* (pp. 305-385). New York, NY: Plenum.
- Zaccaro, S.J., Heinen, B., & Shuffler, M. (2009). Team leadership and team effectiveness. In C.S. Burke, G.F. Goodwin, & E. Salas (Eds.). *Team effectiveness in complex organisations: Cross-disciplinary perspectives and approaches* (pp. 83-111). New York, NY: Routledge.
- Zaccaro, S.J., Rittman, A.L., & Marks, M.A. (2001). Team leadership. *The Leadership Quarterly*, 12, 451-483
- Zalesny, M.D., Salas, E., & Prince, C. (1995). Conceptual and measurement issues in coordination: implications for team behaviour and performance. In G.R. Ferris (Ed.), *Research in personnel and human Work Groups and Teams resources management* (pp. 81-116). Greenwich, CT: JAI Press.

- Zhao, H. (2006). Expectations of recruiters and applicants in large cities of China. *Journal of Managerial Psychology*, 21(5), 459-475.
- Zheng, W., Yang, B., & Mclean, G. (2010). Linking organisational culture, structure, strategy, and organisational effectiveness: Mediating role of knowledge management. *Journal of Business Research*, 63, 763-771.
- Ziman, J. (1998). Why are scientists now expected to be so much more ethically sensitive than they used to be? *Science*, 282, 1813-1814.
- Zimmerman, D., & Zumbo, B.D. (1993). Relative power of the Wilcoxon test, the Friedman test, and the repeated-measures ANOVA on ranks. *Journal of Experimental Education*, 62, 75-86.
- Zupan, N., Kaše, R., Rašković M., Wang, C., & Yao, K. (2015). Getting ready for the young generation to join the workforce: A comparative analysis of the work values of Chinese and Slovenian business students. *Journal of East European Management Studies*, 20(2), 174-201.

## **APPENDIX A**

### **PIENAAR GRADUATE LEADER COMPETENCY QUESTIONNAIRE**

#### **[PGLCQ] – SELF-RATER VERSION**

## CONSENT TO PARTICIPATE IN RESEARCH

Dear prospective research participant

### The development and psychometric evaluation of a graduate leader competency questionnaire

My name is Jacques Pienaar, a student at the Department of Industrial Psychology at the University of Stellenbosch, and I would like to invite you to take part in a study, the results of which will contribute to a research project in order for me to complete my PhD dissertation. Please take some time to read the information presented here, which will explain the details of this project. Although your organization has already given me permission to conduct the research at your company, your participation is entirely voluntary and you are free to decline to participate. If you say no, this will not affect you negatively in any way whatsoever. You are also free to withdraw from the study at any point, even if you do agree to take part in the study now.

The purpose of the study is to develop an instrument for measuring graduate (leader-in-training) performance. It is anticipated that the results of my research will not only be valuable for academic reasons, but also for your company and their graduate (recruitment and development) initiatives. This is a step towards gathering more information on complex human behaviour and especially the reasons for why graduate (leader) performance varies. Understanding this type of behaviour could contribute to identifying and developing the next generation of graduate leaders. In order to do so, I am asking graduates (leaders-in-training) to rate themselves on a number of different competencies that are deemed to be crucial in becoming high performance leaders by way of an online questionnaire. This questionnaire resembles a sort of an informal performance review where you have the opportunity to rate your own performance on a number of (leadership) competencies (that may not necessarily have any relevance to your current job in the organisation, but provides information about future leadership potential). Your manager or direct supervisor will also be asked to rate you on these same competencies. This is why we require you to provide your name and surname in the biographical part of this questionnaire – i.e. we need to link your ratings with the ratings given to you by your manager or supervisor.

### RIGHTS OF RESEARCH PARTICIPANTS:

You have the right to decline answering any questions and you can exit the questionnaire at any time without giving a reason. You are not waiving any legal claims, rights or remedies because of your participation in this research study. If you have questions regarding your rights as a research participant, contact Mrs Maléne Fouché [mfouche@sun.ac.za; 021 808 4622] at the Division for Research Development at Stellenbosch University.

Although you might initially feel tense or apprehensive about participating and revealing your identity due to this exercise resembling an actual performance review, let me just assure you that your responses as well as that of your manager or supervisor will be kept confidential and that **it will not be used for this purpose**. It will only be used for research purposes and the development of a questionnaire that could be incorporated by your organization for future performance reviews. Your responses to the questionnaire as well as that of your manager or supervisor **will not influence** your ongoing career in the organization (or any other) nor your financial remuneration and increases in any way. Except for myself, only my supervisor will have access to the data and my records of your answers. I will not include your personal information in these records that I store in the data file. The data file will also be kept secure on a password-protected computer. Only aggregated statistics of your responses (along with that of others) will be reported and disseminated. The identities of participants will never be revealed. The identity of participating organisations will also not be revealed.

If you have any questions or concerns about the research, please feel free to contact Jacques Pienaar (083 236 4108 or [jacquespienaarorama@gmail.com](mailto:jacquespienaarorama@gmail.com)) or Prof Callie Theron of the Department of Industrial Psychology at Stellenbosch University (084 273 4139 or [ccth@sun.ac.za](mailto:ccth@sun.ac.za)). Please save a copy of this form on your computer for future referral.

**I confirm that I have read and understood the information provided.**

YES

NO

**I agree to take part in this online performance questionnaire.**

YES

NO

## OVERVIEW

### 1. INTRODUCTION

Graduate leadership performance is defined as a network of structural relations existing between an inter-related set of latent behavioural performance dimensions and an interrelated set of latent outcome variables valued by the organisation. The questionnaire attempts to assess the level of competence that graduate leaders display on the latent behavioural graduate leadership performance dimensions. Your ratings, along with other respondent ratings, will be used to determine the suitability of questionnaire items as well as the overall performance rating to measure graduate leaders' performance. The questionnaire will help to assess which dimensions of graduate leadership performance graduates do well on and on which dimensions performance could be improved. This could provide valuable formative feedback during the graduate development programme.

### 2. INSTRUCTIONS

The self-rater version of the Pienaar Graduate Leader Competency Questionnaire (PGLCQ) consists of 90 items measuring nine dimensions. The questionnaire is a self-rater questionnaire, thus you need to evaluate your own behaviour.

- Please read each item carefully and choose the appropriate response (1-5) that best describes your behaviour **over the past 12 months** for that specific dimension.
- Make a (X) over the corresponding score value.
- Do not over-think your answers and rate yourself according to your initial response.
- Completion of the PGLCQ would take about 25 minutes.
- The questionnaire consists of two sections, Section A - Biographical Information, Section B- PGLCQ.
- All questions must be answered as honestly as possible.

### 3. EXAMPLE

In your response to items comprising each subscale you should indicate to what extent you displayed the specified behaviour over a 12-month period that best describes your standing on the specific behavioural graduate leadership performance dimension, such as *ANALYSES AND UNDERSTANDS THE EXTERNAL AND INTERNAL WORK UNIT ENVIRONMENT* for example. If *Environmental scanning* is taken as an example of behaviour in which the latent performance dimension *ANALYSES AND UNDERSTANDS THE EXTERNAL AND INTERNAL WORK UNIT ENVIRONMENT* expresses itself and let's say if you rarely scanned the environment in which your unit (team) operates and most competitive intelligence you gather was obtained purely by chance over the last 12 months, the response option 1 should be selected by placing a cross in the box (over the text) below the appropriate number (see example below). If, however, you have conducted a thorough review of the environment (i.e. industry, market, customer needs, actual place of work, governmental regulations, etc.) in which your unit (team) operates at least 4 times **over the past 12-month period**, the "strength" option should be marked by placing a cross in the box (over the text) below the appropriate number. **Please use the whole scale.** Options 2 and 4 also constitute permissible response options even though they have no behavioural anchors. Response option 6 (cannot rate) should be used as seldom as possible and only if insufficient evidence is available to provide a valid rating.

<b>B</b>	<b>ANALYSES AND UNDERSTANDS THE EXTERNAL AND INTERNAL WORK UNIT ENVIRONMENT: Systematically surveys and immerses self in the internal and external environment of the unit (team) to collect and interpret information about critical occurrences or conditions on behalf of the unit (team) as input to unit (team) performance planning.</b>						
	<b>Denotations</b>	<b>Significant development area 1</b>	<b>Development area 2</b>	<b>On par/satisfactory 3</b>	<b>Strength 4</b>	<b>Well-developed strength 5</b>	<b>Cannot rate 6</b>
<b>B1</b>	<b>Environmental scanning</b>	I rarely scan the environment in which my unit (team) operates and most competitive intelligence I gather is obtained purely by chance.	I do make an effort to collect information on conditions/events/occurrences that can influence the unit's (team's) performance, but only when high-profile, macro events/changes occur and are reported in the media that prompts me to do so.	As a rule, I conduct a thorough review of the environment (i.e. industry, market, customer needs, actual place of work, governmental regulations, etc.) in which my unit (team) operates on a half-yearly basis.	I conduct a thorough review of the environment (i.e. industry, market, customer needs, actual place of work, governmental regulations, etc.) in which my unit (team) operates at least 4 times a year.	I systematically immerse myself and thoroughly survey the environment (i.e. industry, market, customer needs, actual place of work, governmental regulations, etc.) in which my unit (team) operates on a continuous basis.	<b>6</b>

## SECTION A BIOGRAPHICAL INFORMATION

Please complete the biographical section by either making an “X” in the appropriate column or filling in text where required. The information is necessary to characterise the sample in the research study.

A1	<b>Identity</b>	Please specify name and surname														
A2	<b>Age</b>	Please specify in years														
A3	<b>Highest academic qualification</b>	1			2			3			4					
		Bachelor's degree			Honour's degree			Master's degree			Doctoral degree					
A4	<b>Area of study</b>	1			2			3			4		5		6	
		Accounting Sciences			Commerce			Engineering			Social Sciences		Health Sciences		Other (please specify)	
A5	<b>Home language</b>	1	2	3	4	5	6	7	8	9	10	11	12			
		Afrikaans	English	Ndebele	Northern Sotho	Sotho	Swazi	Tsonga	Tswana	Venda	Xhosa	Zulu	Other			
A6	<b>Gender</b>	1						2								
		Male						Female								
A7	<b>Race</b>	1			2			3			4		5		6	
		Asian			Black African			Coloured			Indian		White		Other	
A8	<b>Your geographic location</b>	Please specify the province and town/city where you reside/work														
A9	<b>University<sup>392</sup></b>	Please provide name														

<sup>392</sup> Please indicate the name of the university where you completed your highest academic qualification.



**SECTION B  
PGLCQ**

Please complete the PGLCQ section by making an “X” in the appropriate column. Please use the “cannot rate response option” as seldom as possible.

<b>A PERSONAL LEADER PROFICIENCY: Functions as a well-rounded, sought-after and high impact resource in my unit (team)</b>							
	<b>Denotations</b>	<b>Significant development area</b>	<b>Development area</b>	<b>On par/satisfactory</b>	<b>Strength</b>	<b>Well-developed strength</b>	<b>Cannot rate</b>
		<b>1</b>	<b>2</b>	<b>3</b>	<b>4</b>	<b>5</b>	<b>6</b>
<b>A1</b>	<b>Personal performance contribution</b>	I consistently struggle to make any significant personal contributions to my unit/team's performance outcomes.	I consistently make below average personal contributions to the performance outcomes of my unit (team).	I consistently contribute at least as much to my unit's (team's) performance outcomes as the average member in it.	I consistently make above average personal contributions to the performance outcomes of my unit (team).	I consistently make significant personal contributions to my unit's (team's) performance outcomes.	<b>6</b>
<b>A2</b>	<b>Reputation for adding value</b>	I am routinely overlooked and not asked to become involved and contribute when ad-hoc projects arise that do not fall within the scope of my normal daily duties.	Usually, I am not asked to contribute my personal expertise and experience to projects that fall outside of the scope of my normal duties at work.	In areas of personal expertise and experience, I am often asked to become involved in projects that fall outside the scope of my normal duties at work.	Even if not in areas of personal expertise and experience, I am sometimes asked to contribute to projects that fall outside the scope of my normal duties at work.	I am routinely asked to become involved in all projects that do not fall within the scope of my normal duties at work, whether I have experience (or a background) in dealing with the issue at hand or not.	<b>6</b>
<b>A3</b>	<b>Perceived competence</b>	When tasked with a particularly challenging project, others quickly move in to try to cover for my perceived weaknesses.	Others often try to shield me from tough situations and challenging assignments.	Others regard me in the unit (team) as a contributor that can hold my own in relatively tough assignments and situations.	Others regard me in the unit (team) as a highly competent and tough contributor, even in challenging situations.	Even under extreme pressure, my presence makes others feel completely calm, that we are in charge of the performance process and have things under control.	<b>6</b>
<b>A4</b>	<b>Team dynamics</b>	I think the members of my unit (team) can be effective in what they do whether I am there to support them in their efforts or not.	Sometimes I feel I that my presence is required for my unit (team) to perform, whilst at other times I do not.	I consistently seem to be part of the glue that holds my unit (team) together and makes the required performance possible there.	Other members regard me as a very important cog in my unit's (team) 'performance wheel'.	Other members regard me as indispensable to my unit's (team) performance equation.	<b>6</b>
<b>A5</b>	<b>Intellectual impact</b>	I almost never seem to make the right decisions in a timely manner and have no real ideas for adding value to my unit (team).	My decision-making quality and timing needs some work and I struggle to contribute ideas of any real value to my unit (team).	Sometimes I make great/timely decisions and contribute some great ideas that improve the performance of my unit (team).	More often than not, my decision-making is sound/timely and my ideas contribute to performance improvement in my unit (team).	I consistently and efficiently make good decisions and contribute ideas that enhance my unit's (team's) performance.	<b>6</b>

	Denotations	Significant development area	Development area	On par/satisfactory	Strength	Well-developed strength	Cannot rate
		1	2	3	4	5	6
<b>A6</b>	<b>Retrenchment pecking-order</b>	If the company is struggling financially and had to let people go, I think I would be in the first group that would be retrenched.	If the company is struggling financially and had to let people go, I would be one of the borderline cases that would be lucky to keep my job.	I probably would have a slightly better chance than the average organisational member to keep my job when lay-offs are imminent.	I am part of what makes the organisation tick so I would be relatively safe if a part of the workforce had to be retrenched.	I think that when retrenchments are imminent, I would be one of the last people that the company would want to let go.	<b>6</b>
<b>A7</b>	<b>Project team/group selection popularity</b>	More often than not, I am the last person to be picked onto a newly formed task/project group in my unit (team).	I am usually a second round pick for selection onto a newly formed task/project group in my unit (team).	I am usually picked somewhere during the first round of selection for a newly formed task/project group in my unit (team).	I am usually among the first two picks for selection onto a newly formed task/project group in my unit (team).	I am usually the first person to be selected onto a task/project group in my unit (team).	<b>6</b>
<b>A8</b>	<b>Collective performance</b>	I really struggle to get others around me to work with each other and myself for the collective to perform better.	I cannot seem to get the majority of people around me to work with each other and myself to perform better.	My performance at work in terms of how I get others around me to work together and with myself to improve our performance is adequate.	I tend to get things done and take others along with me in doing so.	I achieve extremely challenging performance objectives and take others along with me in doing so.	
<b>A9</b>	<b>Influence of opinion</b>	My opinion is rarely consulted nor acknowledged by others in my unit (team).	Sometimes, members I am close to in my unit (team) would ask me for advice on a variety of matters.	My opinion on various matters are often consulted and the significance thereof acknowledged by the people around me.	My opinion matters greatly to others and is often used as the basis for exploring solutions to problems in my unit (team).	My opinion is highly sought after, and I easily get buy-in to make tough decisions to improve my unit (team).	<b>6</b>
<b>A10</b>	<b>Collaboration</b>	I think that most people do not really enjoy working with me on projects/assignments.	The experience of working with me could be a good experience for specific types of people.	In general, I make effort with people and get along well with others I work with on different assignments/projects.	People who I work with walks away from time spent with me with a positive experience.	People describe the experience of working with me as thoroughly pleasurable, extremely exciting and highly constructive.	

	Denotations	Significant development area 1	Development area 2	On par/satisfactory 3	Strength 4	Well-developed strength 5	Cannot rate 6
<b>B</b>	<b>ANALYSES AND UNDERSTANDS THE EXTERNAL AND INTERNAL WORK UNIT ENVIRONMENT: Systematically surveys and immerses self in the internal and external environment of the unit (team) to collect and interpret information about critical occurrences or conditions on behalf of the unit (team) as input to unit (team) performance planning.</b>						
<b>B1</b>	<b>Environmental scanning</b>	I rarely scan the environment in which my unit (team) operates and most competitive intelligence I gather is obtained purely by chance.	I do make an effort to collect information on conditions/events/occurrences that can influence my unit's (team's) performance, but only when high-profile, macro events/changes occur and are reported in the media that prompts me to do so.	As a rule, I conduct a thorough review of the environment (i.e. industry, market, customer needs, actual place of work, governmental regulations, etc.) in which my unit (team) operates on a half-yearly basis.	I conduct a thorough review of the environment (i.e. industry, market, customer needs, actual place of work, governmental regulations, etc.) in which my unit (team) operates at least 4 times a year.	I systematically immerse myself and thoroughly survey the environment (i.e. industry, market, customer needs, actual place of work, governmental regulations, etc.) in which my unit (team) operates on a continuous basis.	<b>6</b>
<b>B2</b>	<b>Information dissemination</b>	I rarely if ever extract, interpret and disseminate vital environmental analytics for my unit (team).	I do extract and disseminate vital environmental analytics for my unit (team) but do so mostly at a superficial level and often only when prompted to do so.	I do extract and disseminate vital analytics for my unit (team), sometimes even at a sophisticated level of analysis, but can be more proactive in doing so.	As a rule, I manage to convey the most important implications/repercussions of pertinent environmental analytics to my team as and when new information becomes available.	I reactively and proactively extract, expertly interpret and comprehensively disseminate all relevant and vital environmental analytics for my unit (team) on a continuous basis.	<b>6</b>
<b>B3</b>	<b>Competitive intelligence</b>	I do not really know where to start looking for information about the operational environment that could provide my unit (team) with an advantage over the opposition.	I manage to extract some information about the operational environment to affect small improvements in the unit's (team's) performance.	Usually, the information that I extract and share with my unit (team) puts us on par with the competitiveness levels of the opposition.	The information I extract from the operational environment provides my unit (team) with a competitive edge over the opposition.	I extract, share and utilise information about the environment in which the unit (team) operates in order to make my unit (team) the leader in the market/industry in which we operate.	<b>6</b>
<b>B4</b>	<b>Information processing</b>	The pure magnitude of the information that could affect my unit's (team's) performance and that is available to me in the environment is confusing and prevents me from extracting any meaningful competitive intelligence.	I can make some sense of the bewildering amount of information that is available in the environment and that can impact my unit's (team's) performance but it takes me a considerable amount of time to do so.	I am competent at deducing the implications/repercussions for my unit's (team's) functioning from a magnitude of information available in the environment quite quickly but may at times oversee the extremely complex, 'veiled' signals and messages hidden there.	I have mastered the ability to quickly make sense out of a (even complex) magnitude of different information sources in the environment but sometimes may struggle to do so when the market is highly chaotic and unstable.	I can quickly cut through the bewildering array of environmental information available, even in an unstable/chaotic market to identify critical occurrences/conditions that may have an impact on my unit's (team's) functioning.	<b>6</b>

	Denotations	Well below standard 1	Below required standard 2	Satisfactory 3	Above required standard 4	Well above standard 5	Cannot rate 6
B5	<b>Situational awareness</b>	I struggle to stay abreast of changing conditions/occurrences that have a direct effect on my unit's (team's) ability to compete optimally.	I am sometimes able to spot changes in the more obvious conditions in the market that have a direct effect on my unit's (team's) ability to compete optimally.	I am reasonably good at identifying changes in the more obvious market conditions that have a direct effect on my team's (unit's) ability to compete optimally and usually act on this information in time.	I am quite astute at identifying changes in both the more obvious and complicated market conditions that have a direct effect on my team's (unit's) ability to compete optimally and usually act on this information in time.	Through my monitoring of the environment, my unit (team) is continuously aware of almost all the possible changing conditions/occurrences in the environment that have a direct effect on its ability to compete optimally.	6
B6	<b>Awareness of internal capability</b>	I am somewhat ignorant of my entire unit's (team's) talent profile (i.e. capabilities, strengths, weaknesses, skills, qualifications, etc.).	I am informed only on the more important, high-level details of my entire unit's (team's) talent profile (i.e. qualifications, experience).	I have a reasonably thorough understanding of the talent profile of my unit's (team's) core, senior members but less so with regards to new or junior members whose profiles I am only familiar with at a superficial level.	I have a decent and thorough understanding of my entire unit's (team's) talent profile and make an effort to keep updated on changes, improvements or downgrades that occur in this area.	At any point in time, I have a deep, penetrating understanding of my unit's (team's) talent profile.	6
B7	<b>Future trends</b>	I fail to spot trends in the market that can affect the performance levels of my unit (team) in the future.	At best, I can sometimes spot macro level trends in the environment that may affect the performance of my unit (team) in the future.	I am usually aware of all of the more obvious trends/opportunities that may affect the performance of my unit (team) in the future.	I am usually aware of obvious and even hidden (veiled) trends in the environment that may affect the performance of my unit (team) in the future.	I have the knack of "spotting" overt as well as veiled trends/opportunities/threats that will affect my unit (team), sometimes even before they actually occur.	6
B8	<b>Operational efficiency awareness</b>	I am entirely in the dark when it comes to the operational efficiency of my unit (team).	I am somewhat removed from the on-going operational efficiency of my unit (team).	I monitor only certain high-level aspects of my unit's (team's) operational efficiency on a daily basis (i.e. project deadlines, output) so that I can maintain a helicopter view of how we are performing.	I regularly monitor the detail of the operational efficiency of the unit (team).	At any given point in time, I can provide accurate and in-depth information on the current operational efficiency of the unit (team).	6
B9	<b>Social capital utilisation</b>	I do not really have (or am not able to utilise) contacts, friends and colleagues who can assist me when trying to extract information that are pertinent to my unit's (team's) current and future operational performance.	I rarely utilise my contacts, friends and colleagues to extract information from them that are pertinent to my unit's (team's) current and future operational performance.	I gain insights/knowledge/information from my friends, colleagues, contacts and the people who I engage with at important, yet infrequent events that are pertinent to the unit's (team's) current and future operational performance.	I stay in reasonably regular contact with friends, contacts, colleagues and other people in order to extract information from them that are pertinent to my unit's (team's) current and future operational performance.	I regularly gain insights/knowledge/information from my friends, colleagues, contacts and the people who I engage with on a daily basis that are pertinent to the unit's (team's) current and future operational performance.	6

<b>B10</b>	<b>Timeliness of information sharing</b>	I acquire/share competitive intelligence much too late for others in my unit (team) to be able to capitalise on this information.	Sometimes I manage to share competitive intelligence to others in my unit (team) to capitalise on this information, while at other times delays from my side results in opportunities slipping through our fingers.	I manage to share the most important parts of competitive intelligence to my unit (team) in order for them to capitalise on this information, more often than not.	I almost always manage to share the most important parts of competitive intelligence to my unit (team) in order for them to capitalise on this information.	I always share all forms of competitive intelligence on time in order for others in the unit (team) to capitalise on all windows of opportunity that comes our way.	<b>6</b>
------------	--	---	---	--	---	---	----------

<b>C CREATES AN EXCITING AND ASPIRATIONAL VISION FOR THE UNIT: Attracts and rallies a wide follower base towards and inspiring and exciting vision of what can be achieved and how their lives can be fulfilled and become more meaningful by investing in such a cause.</b> *Note: Vision in this context can refer to a formal or informal future end-state that the graduate (leader in training) either explicitly expresses for the collective and strives towards along with the unit (team) or (even implicitly) strives towards and demonstrates allegiance to by way of his/her own personal capacity and conduct at work.							
	Denotations	Significant development area	Development area	On par/satisfactory	Strength	Well-developed strength	Cannot rate
		1	2	3	4	5	6
<b>C1</b>	<b>Captivating cause</b>	I struggle to captivate others around me with a vision of a desirable future, an end-state of where we are going and what we can work towards.	I have managed to enthrall a few of the members in my unit (team) with a vision of a desirable future of what we can work towards but not the majority.	My vision of where we could be going and what we can be working towards has created a tipping point for collective action.	My vision for the future and the message behind it has captivated the majority but not all of the members of my unit (team).	My vision of where we could be going to and what we can be working towards has captivated the hearts and minds of almost all the members of my unit (team).	<b>6</b>
<b>C2</b>	<b>Member attraction</b>	The vision I articulate and work towards fails to attract any additional members to this cause.	The vision I articulate and work towards fails to attract any significant amount of additional members to this cause.	The vision that I have articulated and work towards has attracted a few people to this cause.	Quite a number of new members have joined my cause since I have started to articulate and work towards this vision at work.	People respond to my way of thinking about the future and the vision that I have articulated and that I work towards has 'infected' many others to join and gravitate towards this cause.	<b>6</b>
<b>C3</b>	<b>Member ambition</b>	The cause that I have articulated and that I am working towards seems to be limiting and constraining unit (team) member ambitions and dreams, rather than growing them.	Since I have communicated and started working towards a vision, unit (team) member ambitions and dreams have remained largely the same as before.	Since I have communicated and started working towards a vision, the ambitions and dreams of unit (team) members have expanded and grown to a certain extent towards this.	The vision that I have articulated and work towards has greatly increased the ambitions and dreams of the average unit (team) member.	I have stretched the unit (team) member's ambitions and dreams by describing them and demonstrating an allegiance to a valued, future end-state as a highly attractive alternative to the current (and dreary) status quo.	<b>6</b>
<b>C4</b>	<b>Member confidence</b>	Nobody in my unit (team) believes that the vision that I have articulated and that I am working towards is actually attainable.	The majority of the unit (team) seems to be sceptical about the possibility of attaining the vision that I have articulated and that I am working towards.	The cause that I have communicated and am working towards convinces some important unit (team) members that this vision is not only a pipe dream but that it is in fact, attainable and possible.	In the process of articulating and working towards a vision, I have actually raised the self-confidence of the majority of the unit (team) members in addition to convincing them of its viability.	I have utilised a desired future state of what we can become as a rhetorical device through which to persuade and raise the levels of confidence in almost all unit (team) members that this vision is realistic and attainable.	<b>6</b>
<b>C5</b>	<b>Identification with the cause</b>	Nobody in my unit (team) or outside it seems to genuinely identify with the vision that I have articulated and that I am working towards.	Some unit (team) members (and outsiders) have identified with the cause that I have articulated and that I am working towards voluntarily and easily while others seem to experience negative tension to conform and simply comply/align with this cause on a superficial level.	In general, the desired future that I have articulated and that I am working towards is met quite well and unit (team) members voluntarily attempt to align with the ideals implied by it.	In general, the desired future that I have articulated and that I am working towards is met quite well and even some outsiders spontaneously align with the ideals implied by it.	I have created a desired future in the minds of almost all of my unit's (team) members that creates a positive tension for identity transformation to occur within them (and parties external to the organisation) in aligning with my ideal(s).	<b>6</b>

<b>C6</b>	<b>Aspirational cause</b>	Almost nobody in my unit (team) seems to be genuinely excited about the direction that I have mapped out and almost nobody demonstrate allegiance to it.	The vision that I have articulated and that I am working towards fails to excite the majority of my unit's (team's) members and is not aspirational enough for the collective to move forward or align with it.	Because of the vision that I have articulated and that I am working towards, a certain level of hope and excitement is evident in most members in the unit (team).	The desired future end-state that I have articulated and that I am working towards is highly aspirational, excites the majority of members and fills them with hope of a better (work) life to come.	I develop, express and share an ideal, valued and as of yet unfulfilled future, that almost all members and a number of external parties come to internalise because it fills them with an aspirational life purpose filled with hope and excitement.	<b>6</b>
<b>C7</b>	<b>Attractive end-result</b>	The end-result associated with the vision that I have imagined and work towards appears disconnected to the way the world is moving and unattractive to unit (team) members and outsiders alike.	While not an entirely unattractive/unrealistic option to the status quo altogether, the end-results of the vision I have articulated and strive towards are relatively bland and non-inspirational.	In my vision that I have articulated and work towards, I believe that I have managed to capture some of the main attractive possibilities, benefits and/or end-results that are important to all members in my unit (team).	I believe that I have managed to capture 'universal needs' that are in touch with our industry, the way the world is moving, and that are important to all unit (team) members when articulating the end-results, opportunities or benefits that they can expect when working together to realise my vision.	I create tangible meaning and purpose for people by gazing across the horizon of time and articulating the attractive opportunities that are store for when the unit (team) arrives at a distant destination.	<b>6</b>
<b>C8</b>	<b>Higher life purpose</b>	The message behind the desired future end-state that I have articulated and work towards does not persuade members of my unit (team) to challenge/subvert their own personal motives and concerns in favour of it, even for a short while.	The message behind my vision does slant towards a purpose higher than unit (team) member personal concerns, motives and needs but is not powerful enough to bind them into a collective force around this.	In general, I can see that the desired future end-state that I have articulated and work towards does, to a certain extent, bind unit (team) most members together around a purpose higher than themselves.	The desired future end-state that I have articulated and am working towards is successful in persuading most unit (team) members to subvert their personal motives, needs and concerns and accept/internalise the message behind my vision's higher calling instead.	I appeal to (aspiring) followers' inherent human nature that strives for identification with a morally superior, higher life meaning/purpose, and leverage this appealing proposition to win people (unit members and outsiders) over to my cause.	<b>6</b>
<b>C9</b>	<b>Commitment</b>	The power of the message behind the vision that I have articulated and that I am working towards is not likely to result in any unit (team) members committing to this cause for any significant amount of time.	The power of the message behind the vision I have communicated and that I am working towards could conceivably tempt some individual team unit (team) members to commit themselves to this cause for the long run.	The power of the message behind the vision I have communicated and that I am working towards is strong enough for a significant proportion of unit (team) members to commit to this purpose over the long-term.	The message behind the vision I have communicated and that I am working towards is powerful, and persuades most members to commit to working towards this better future.	I articulate the unit (team) members' inherent human need to be part of something bigger, stronger and better than themselves as part of my vision for the unit (team) in motivating almost all of them to commit to working towards a better future.	<b>6</b>
<b>C10</b>	<b>Self-efficacy beliefs</b>	If fail to convince members that they have the knowledge, skills and abilities to make my vision a reality.	The vision I have articulated and that I am working towards fails to adequately connect with unit (team) members in terms of their beliefs that they have the knowledge, skills and abilities that are required to make this vision a reality.	As part of the articulation of my vision, I have managed to convey the general message that unit (team) members have the knowledge, skills and abilities necessary to bring the vision to fruition.	I have consistently communicated and grown the belief in unit (team) members that they have the knowledge, skills and abilities to attain my vision of a more desirable future end-state.	I utilise expressions of a highly desirable future to create optimism in almost all unit (team) members and fuel their beliefs that they have the knowledge, skills and abilities necessary to bring my vision to fruition.	<b>6</b>

D	<b>ENTRENCHES A HIGH-PERFORMANCE CULTURE IN THE UNIT: Consistently behaves and makes decisions in a manner that serves the human condition by eliciting positively valenced psychological functioning in followers.</b>						
	<b>Denotations</b>	<b>Significant development area</b>	<b>Development area</b>	<b>On par/satisfactory</b>	<b>Strength</b>	<b>Well-developed strength</b>	<b>Cannot rate</b>
		<b>1</b>	<b>2</b>	<b>3</b>	<b>4</b>	<b>5</b>	
<b>D1</b>	<b>Human engagement</b>	I treat other members in the unit (team) as <i>performance machines</i> .	My actions, decisions and the ways in which I engage with unit (team) members are professional, yet somewhat clinical and indifferent.	I treat everyone as professionals, fairly and with the necessary amount of respect as per their station in the unit (team).	I go out of my way to make everyone feel like they are respected human beings and valued members of the unit (team).	The decisions I make and the way I engage unit (team) members reflect my respect for all members irrespective of rank or position and resonate with them as human beings that aspire to a better way of life.	<b>6</b>
<b>D2</b>	<b>Energising others</b>	My actions and behaviours towards others drain the energy of them at work.	My actions and behaviours towards others somewhat stifle their natural energy at work.	My actions and behaviours towards others in general succeeds in energising the most important members in the unit (team).	As a rule, my everyday conduct elicits positive energies from the other members in the unit (team).	My actions and behaviours consistently energise all unit (team) members towards improved performances at work.	<b>6</b>
<b>D3</b>	<b>Performance role-model</b>	The type of behaviours I model at work do not inspire performance (or product/service) improvement in others at all.	Despite sometimes trying, my behaviours do not seem to inspire others to any significant performance (or product/service) improvements at work.	I succeed in role modelling the required performance (or product/service) standards at work and this appears to cascade down to some members in my unit (team).	I succeed in role modelling more than the required performance (or product/service) standards at work and this appears to cascade down to the majority of members in my unit (team).	Through the consistent role modelling of outstanding performance over time, I have contributed to a special "personality"/high performance culture in my team (unit) that inspire members to higher performances (better product/service offerings) at work.	<b>6</b>
<b>D4</b>	<b>Servitude</b>	I take what I can from others to improve my own situation and I actively enforce policies and rules in order to protect my position in my unit (team).	I try to keep others from cutting corners and protect myself from reprimands by actively enforcing company rules/policies and other bureaucratic procedures.	Whenever, I can and within reason, I try to be there for others in my unit (team) and remove overly bureaucratic obstacles out of their way.	I reposition myself as an empathetic 'helper' in my unit (team) and fulfil this role by assisting others in making their daily work easier and more enjoyable.	I act in complete servitude of others and do everything in my power to make the work environment in my unit (team) more employee-centric/friendly for them and to remove (bureaucratic) obstacles out of their way.	<b>6</b>
<b>D5</b>	<b>Psychological climate</b>	Others from the outside seem to avoid (joining) our unit (team) because of the forbidding and unhealthy climate that I create or contribute to in my unit (team).	I have a bit of a reputation for being part of the cause for an amount of dissatisfaction with the negative and tense psychological climate that prevails in the unit (team).	In general, the psychological climate I create/contribute to in my unit (team) is positive and appealing to others.	The psychological climate I create/contribute to is upbeat, healthy and motivates most members in the unit (team) to express extra effort in their work.	Others from outside often wants to join our unit (team) and contribute because they value the way I protect/stand up for and emphasise with others when necessary and (contribute) to nurture a psychologically positive and performance stimulating climate in the unit (team).	<b>6</b>
<b>D6</b>	<b>Psychological safety I</b>	Fellow unit (team) members seem to creep back into their shells because of the critical, impersonal, and inconsistent manner in which I engage with others.	My inconsistent and unfair conduct sometimes 'scare' other people in the unit (team) to hide their 'full' selves at work from me and from others in the unit (team).	Generally speaking, my decisions, actions and behaviours are fair and consistent and make unit (team) members feel psychologically safe to express and be themselves at work.	Through consistently fair and up-building actions and behaviour, I demonstrate to others that I welcome the authentic expression of everyone at work.	I inspire members in my unit (team) to apply themselves authentically to their work because my behaviour is fair and consistent and greatly contribute to the environment and conditions in which they feel psychologically safe and motivated to do so.	<b>6</b>



<b>D7</b>	<b>Psychological safety II</b>	My behaviours, decisions and actions demonstrate allegiance to my position and not to those around me.	I demonstrate allegiance to some of the colleagues close to me in my unit (team) but generally, my decisions and actions are governed by what my position in my unit (team) requires from me and not the welfare of others.	I prioritise allegiance equally between others around me and the responsibilities of my position.	In general, my behaviours and decisions are aimed at protecting and nurturing those around me in addition to doing my job.	My behaviours, decisions and actions demonstrate total allegiance to and care for the people around me in addition to what is required of me in my position.	<b>6</b>
<b>D8</b>	<b>Improvement motivation</b>	My actions and behaviours at work do not seem to motivate others in my unit (team) to become better in their jobs and in life in general at all.	I struggle to get others to buy into the idea that they can be better employees and people through my conduct at work.	My conduct at work succeeds in getting some of the others to follow my lead in being better employees and human beings.	My conduct at work succeeds in getting the majority of my unit's (team) members to strive towards being better employees and human beings.	My actions and behaviours motivate almost all unit (team) members to be better employees and human beings.	<b>6</b>
<b>D9</b>	<b>Morality</b>	I do not demonstrate what my moral beliefs are in the manner in which I conduct myself at work: rather what I do at work and the way I conduct myself is governed by popular opinion and what I need to do in order to keep my job/position in my unit (team).	I demonstrate moral beliefs/principles at work but adapt my actual behaviour/decisions sometimes to what is required in order to remain popular in my unit (team) and protect my career.	I have a strong set of moral beliefs that generally serve as my compass when making decisions that have the potential to negatively affect my popularity and my career in my unit (team).	I make decisions and behave according to a set of strong moral beliefs and it is these principles that govern my behaviours, actions and decisions and not the need to be popular or to preserve my own career in my unit (team).	My actions and behaviours at work demonstrate that I fight for what is right and that I never sacrifice my moral beliefs and principles in order to be popular and advance/preserve my career in my unit (team).	
<b>D10</b>	<b>Responsibility/blame</b>	I am quick to pick up whose fault it was that my unit (team) did not perform and to put all the blame for non-performance on these individuals.	I tend to blame others when the performance of our unit (team) is not up to standard.	I take (my share of the) responsibility for the overall performance of my unit (team) but sometimes when things go wrong badly, I cannot help but to single out certain individuals who played the biggest part in our failure.	Generally, I take (my share of the) responsibility for the overall performance of my unit (team) even when it is clear who was at fault for the failure of the collective.	I take total responsibility for the performance outcomes of our unit (team) and never blame/crucify individuals when things go wrong.	<b>6</b>

<b>E DEVELOPS UNIT COMPETITIVENESS: Develops and secures resources for exploiting viable, eco-friendly and sustainable opportunities necessary for the occupation of a morally superior, winning market position for the unit.</b>							
	<b>Denotations</b>	<b>Significant development area</b>	<b>Development area</b>	<b>On par/satisfactory</b>	<b>Strength</b>	<b>Well-developed strength</b>	<b>Cannot rate</b>
		<b>1</b>	<b>2</b>	<b>3</b>	<b>4</b>	<b>5</b>	
<b>E1</b>	<b>Green performance</b>	I do not manage to align my unit's (team's) performance strategy with environmentally-friendly practices/considerations at all.	Despite some degree of effort on my side, my unit's (team's) performance strategy is not really aligned with universally accepted eco-friendly practices/considerations that are incorporated by other organisations.	I have managed to shape the unit's (team's) performance strategy so as to incorporate most of the mainstream eco-friendly practices/considerations that most other companies ascribe to.	My actions have led to our unit's (team's) performance strategy being aligned to and on par with some of the leading eco-friendly companies around.	Due to my efforts, ground-breaking, market-leading eco-friendly practices form the base framework around which my unit's (team's) performance strategy is designed.	<b>6</b>
<b>E2</b>	<b>Resource security</b>	I struggle to put structures, deals and arrangements in place to secure any sort of high-priority resources for my unit (team) that are necessary for our operational efficiency.	I have managed to secure some high-priority resources for my unit (team) that would have been lost to us if I had not stepped in. In other cases, however, I struggle to secure the resources necessary for our operational efficiency.	I consistently manage to secure most of the important resources my unit (team) needs to stay operationally competitive.	I consistently manage to secure enough resources for my unit (team) so as to allow us scope for increasing our performance/competiveness through the availability of surplus materials, staff and finances.	Due to my actions and efforts, my unit (team) has unfettered and timeous access to almost all resources (human, material, financial) that our operations depend on.	<b>6</b>
<b>E3</b>	<b>Market niche</b>	I have not managed to add anything new and innovative to my unit's (team's) performance strategy at all.	I have managed to identify some new business streams and ideas for consideration in our unit's (team's) performance strategy but nothing that has really paid off substantially.	I have been known to capitalise on new business ventures/streams and ideas to improve our unit's (team's) performance strategy and product/service offering.	I regularly capitalise on new business ventures/streams and ideas to improve our unit's (team's) performance strategy.	My consistent contribution to the performance strategy of my unit (team) is so clever and innovative that due to it, my team (unit) will continue to be relevant and successful in the market for a long time.	<b>6</b>
<b>E4</b>	<b>Buy-in</b>	I have not managed to shape my unit's (team's) performance strategy towards the needs/concerns of any other constituencies of the greater society in which we operate.	I manage to shape my unit's (team's) performance strategy towards compliance with governmental regulations/rules but not the concerns of any of the other relevant constituencies in the society in which we operate.	I have shaped the unit's (team's) performance strategy in such a way so as to address most of the concerns of the constituencies of the society in which we operate (i.e. government, customers, lobby groups, etc.).	I have shaped my unit's (team's) performance strategy in such a way that most constituencies of the society in which we operate will not be able to substantially criticise it on any legitimate grounds.	My contribution to the performance strategy of my unit (team) leads to the widespread acceptance thereof because the concerns of all of the relevant constituencies have been properly consulted due to the manner in which I advocated the importance of such buy-in.	<b>6</b>
<b>E5</b>	<b>Overall impact</b>	My contributions to the performance strategy of my unit (team) does not affect its chances of long-term success at all.	My contributions to the performance strategy of my unit (team) marginally increases its chances of long-term success.	My contributions to the performance strategy of my unit (team) do have some positive impact on the chances of our long-term success.	In general, my contributions to the performance strategy of my unit (team) positively affects our chances of being successful in the long run.	The contribution that I have made to the performance strategy of my unit (team) greatly increases the chances of the unit (team) being successful in the long run.	<b>6</b>

<b>E6</b>	<b>Market standing</b>	I am one of those that consistently fail in trying to position our unit (team) as one of the market leaders in the industry/field in which we operate.	Despite some degree of effort, I cannot manage to influence our unit's (team's) performance strategy to the extent that we can improve our market position so as to become part of the top half of the competitors in the industry/field in which we operate.	My contributions to the performance strategy of my unit (team) have directly led to us becoming part of the top 50-30% of companies in the field/industry in which we operate.	My contributions to the performance strategy of my unit (team) have directly led to us becoming part of the top 20% of companies in the field/industry in which we operate.	The fact that our unit (team) is positioned as one of the top work units (teams) of its kind in the field/industry is greatly due to my contributions to our performance strategy.	<b>6</b>
<b>E7</b>	<b>Process performance</b>	I fail to shape my unit's (team's) performance strategy towards adopting a better/improved production process.	Due to my contributions to the unit's (team's) performance strategy, marginal improvements have been made to our value chain and internal processes.	I routinely impact positively on the quality of our value chain and internal processes through my contributions to my unit's (team's) performance strategy.	In general, I shape my unit's (team's) performance strategy so that we routinely improve and sometimes even revolutionise our value chain and internal processes.	The fact that our unit (team) operates on a world-class conversion process is greatly due to my efforts and input to our performance strategy.	<b>6</b>
<b>E8</b>	<b>Economic performance</b>	My input to our unit's (team's) performance strategy has not really led to any change in our profit margins and has not stimulated economic growth in our community.	My input to our unit's (team's) performance strategy has led to a marginal increase in our profit margins but not any significant economic growth in our community.	My input to our unit's (team's) performance plan has led to consistent increases in our profit margins and stimulated some economic growth in our community.	My input to our unit's (team's) performance plan has led to substantial increases in our profit margins and economic growth in the organisation and our community.	Due to my contributions, the performance strategy of our unit (team) is highly entrepreneurial and stimulates high levels of economic growth in the organisation and our community.	<b>6</b>
<b>E9</b>	<b>Product/Service output performance</b>	My input to our unit's (team's) performance strategy has not led to any improvements with regards to the quality of our products and service delivery.	My input to our unit's (team's) performance strategy has led to marginal improvements with regards to the quality of our products and service delivery.	My input to our unit's (team's) performance strategy has led to decent improvements in our product quality and service delivery.	My input to our unit's (team's) performance plan has led to great improvements in our product quality and service delivery.	The fact that our unit (team) can consistently deliver real value to internal and external customers efficiently, effectively and dependably is greatly due to my efforts.	<b>6</b>
<b>E10</b>	<b>Market benchmark</b>	I am one of those that fail in positioning our unit (team) as the benchmark of competitiveness/excellence in the market in which we operate.	Despite some improvements, I cannot manage to influence our unit's (team's) performance strategy to the extent that we can market ourselves as the benchmark for the competitors in the industry/field in which we operate quite yet.	My contributions to the unit's (team's) performance strategy have resulted in us being able to compete on even footing with some of the leaders in the industry/field in which we operate.	My contributions to the unit's (team's) performance strategy have resulted in us becoming one of the benchmarks of excellence/competitiveness in the market/industry in which we operate.	The fact that others in a similar industry or field regard our performance strategy as the ultimate benchmark of competitiveness/excellence in the market is greatly due to my efforts in developing the blueprint for it.	<b>6</b>

<b>F INVOLVES OTHERS AND ELICITS PARTICIPATION: Provides scope and opportunities for followers to spontaneously contribute their full talents/capabilities.</b>							
	<b>Definitions</b>	<b>Significant development area</b>	<b>Development area</b>	<b>On par/satisfactory</b>	<b>Strength</b>	<b>Well-developed strength</b>	<b>Cannot rate</b>
		<b>1</b>	<b>2</b>	<b>3</b>	<b>4</b>	<b>5</b>	
<b>F1</b>	<b>Managing the contributions of others</b>	I micro manage all my projects and the other unit (team) members that are involved in them by forcing my idea of what needs to be done and how this should be done onto others.	When working with other unit (team) members on a project, I often find myself telling others what they must do and how they must do it.	When working with other unit (team) members on a project, I try to incorporate each members' unique talents, input and contributions for the betterment of the project.	When working with other unit (team) members on a project, I actively encourage them to improvise on the current status quo/performance process.	When I am dependent on other unit (team) members for the success of a project, I give them total freedom and discretion to run their tasks/assignments the way they see fit in order to improve on the current status quo/performance process.	<b>6</b>
<b>F2</b>	<b>Locus of decision-making responsibility</b>	I ascribe to the notion that managers should make all decisions about the performance of the unit (team) and live by this rule.	Sometimes I push for shared decision-making in my unit (team) but at other times, I feel management alone should step in to call the shots.	In my work life, I favour the notion that everyone should be part of the decision-making process about the performance of my unit (team) but can be more proactive in ensuring that this actually consistently happens in our unit (team).	I actively champion the notion that the responsibility for decision-making and performance should be shared equally between managers and staff in our unit (team).	As a result of my actions, shared responsibility (between managers and staff) for decision-making in my unit (team) has become a daily reality for us.	<b>6</b>
<b>F3</b>	<b>Delegation of decision-making authority</b>	I discourage the practice where management delegates decision-making authority to members that may affect the entire unit's (team's) performance.	As a rule, I discourage the practice where management delegates decision-making authority to unit (team) members but under extraordinary circumstances, I would not counter this where it is done.	In general I encourage the practice where management delegates decision-making authority to team members, but mostly only to those members I feel can handle the additional responsibility to do so.	I fight for and welcome the practice where management delegates decision-making authority to all team (unit) members so that they have more freedom to make decisions that affect our jobs and performance at work.	Because of my actions, the extensive delegation of decision-making authority to all team (unit) members has become a daily reality for us in the unit (team).	<b>6</b>
<b>F4</b>	<b>Locus of change authority</b>	I discourage unit (team) members to change a standard work approach, process or strategy and feel uncomfortable when someone actually tries to do so.	As a rule, I discourage others from changing a standard work approach, process or strategy but sometimes under extraordinary circumstances, I would buy in to the need to do so.	I work on the basis that I want everyone to be free to make minor changes to a standard work approach, process or strategy to improve our collective performance but in extreme cases, I still want people to run this by management first.	I work on the basis that senior individuals in the unit (team) should have the authority to change a standard work approach, process or strategy to improve the performance of the collective but that more junior (or new) members should check with management before they do so first.	I always encourage and welcome it when any unit (team) member spontaneously changes/modifies a work approach, process or strategy in order to improve the performance of the unit (team) and accept responsibility for it.	<b>6</b>
<b>F5</b>	<b>Authentic expression</b>	My decisions, actions and behaviours stifle the spontaneity of fellow unit (team) members in contributing their natural talents to the performance process.	Despite good intentions, my conduct sometimes causes some of the weaker members to withdraw themselves from the unit's (team's) performance process.	The way that I engage with members in our unit (team) is generally conducive to them spontaneously applying their natural talents to the performance process.	My daily interactions and engagements with members in my unit (team) stimulate their need to apply their natural talents to the performance process.	My actions and behaviours at work brings the 'authentic' best out of the people in my unit (team).	<b>6</b>

<b>F6</b>	<b>Work scope</b>	Everyone in the unit (team) should follow their job descriptions pedantically and I implement this credence religiously as part of my every day work life.	I live by the rule that job descriptions should be followed to the letter but will not try to counter/discourage it when a unit (team) member gets involved in projects beyond their assigned duties occasionally.	I actively encourage unit (team) members to get involved in projects/assignments/tasks that are not directly related to their normal daily duties and try to make it easier for them to do so.	Because of my efforts, I get most people in our unit (team) a little bit more involved in projects/tasks/assignments that are not directly related to their normal duties at work.	I shape the work environment so as to give all members the freedom to decide how and when to expand their own work roles and become more involved in projects/tasks/assignments that are not directly related to their normal, daily duties.	<b>6</b>
<b>F7</b>	<b>Eliciting input</b>	I do not think that employees should be given the opportunity via meetings to provide their input to decisions that are made about our collective performance and I behave accordingly at work.	I do not ascribe to regular meetings where unit (team) members have the opportunity to provide their opinions on decisions that are made about our collective performance and behave accordingly at work.	I believe there are benefits in having meetings with the purpose of giving unit (team) members the opportunity to provide their input to decisions that are made about our collective performance and behave accordingly at work.	I believe that there are benefits in actively eliciting the input of employees during meetings concerning decisions about our collective performance and behave accordingly at work.	I shape the work environment so as to make frequent meetings during which the opinions of unit (team) members are heard and incorporated into our unit (team) performance decision-making process a daily reality for us.	<b>6</b>
<b>F8</b>	<b>Planning responsibility</b>	Managers are there to completely plan and organise employee projects/tasks on behalf of them and I behave accordingly at work.	Managers should spend a lot of time to assist employees to plan and organise their projects/tasks for them and I behave accordingly at work.	There should be a 50-50 responsibility between management and employees in terms of who plans and organises the work for employees and I behave accordingly at work.	Managers should at least check that employees have planned and organised their projects/tasks correctly and I behave accordingly at work.	I shape the work environment so that unit (team) members have complete authority to make decisions about how to organise, manage and take accountability of their own projects.	<b>6</b>
<b>F9</b>	<b>Spontaneity of contributions</b>	It is not the place of unit (team) members to provide input to unit (team)-decision making and performance when their opinion is not consulted and I behave accordingly at work.	Unit (team) members should try to refrain from providing their input to team decision-making and performance when not asked for their opinion and I behave accordingly at work.	Unit (team) members should sometimes be allowed to provide their input to team decision-making and performance without being asked for their opinion and I behave accordingly at work.	In general, unit (team) members should be allowed to provide their input to team decision-making and performance whenever they feel like contributing and I behave accordingly at work.	I shape and contribute to a work environment where unit (team) members spontaneously provide input to team decision-making and performance whenever they feel the need to do so.	<b>6</b>
<b>F10</b>	<b>Cascading of responsibility</b>	Managers should have complete power over the direction and performance of the collective and I behave accordingly at work.	Only under special circumstances should managers involve unit (team) members with matters concerning the direction and performance of the collective and I behave accordingly at work.	Unit (team) members should be aware of and be able to question the direction and performance strategy of the collective and I behave accordingly at work.	Management should trust their followers' capabilities and natural talents and make them more accountable for the performance of the collective and I behave accordingly at work.	I shape the work environment so as to ensure that management relinquishes power and grooms others to take accountability for the performance of the collective.	<b>6</b>

<b>G UNITES AND CONNECTS FOLLOWERS: Brings followers together and unites them in fortified, mutually supportive relationships.</b>							
	<b>Definitions</b>	<b>Significant development area</b>	<b>Development area</b>	<b>On par/satisfactory</b>	<b>Strength</b>	<b>Well-developed strength</b>	<b>Cannot rate</b>
		<b>1</b>	<b>2</b>	<b>3</b>	<b>4</b>	<b>5</b>	<b>6</b>
<b>G1</b>	<b>Resolving differences</b>	I do not take notice of the dynamics of socio-emotional processes and interactions that take place in my unit (team) at all and let members take care of any personal feuds/ differences that may arise between them themselves.	I am vaguely aware of the changing socio-emotional dynamics in my unit (team) but loathe (or am unable) to step in and assist members to resolve personal differences that may negatively influence team dynamics and performance.	I am aware of the more prominent socio-emotional processes and interactions that occur in my unit (team) and have been known to step in on occasion to avoid that personal differences between members negatively influence unit (team) dynamics and performance.	I am on top of the socio-emotional processes and interactions that exist and occur in my unit (team) and manage to properly resolve most personal differences between members through (informal) mediation and conciliation before they can negatively influence unit (team) dynamics and performance.	I pay close attention to socio-emotional processes and interactions in my unit (team) and openly and promptly resolve personal differences between members fairly and effectively through the appropriate intervention before they can negatively influence team dynamics and performance.	<b>6</b>
<b>G2</b>	<b>Facilitating personal information sharing</b>	I prefer it if unit (team) members do not communicate with each other about their personal lives at all and discourage the sharing of personal information at work.	I leave others to decide for themselves how much of their selves and personal lives they want to share with other members in the unit (team), but I share as little as possible.	I actively try to connect some like-minded, similar people in our unit (team) with each other and myself so that we can provide each other with bits of personal information about ourselves for future support and rapport.	I encourage even diverse unit (team) members to share personal information with each other and myself so that we can give and receive support from each other and build a basis for understanding and mutual support.	I encourage and create many informal opportunities for all unit (team) members at work to give and receive support, get glimpses of each other's lives and share personal information with each other to build understanding rapport.	<b>6</b>
<b>G3</b>	<b>Facilitating work life sharing</b>	I prefer it if unit (team) members stick to their own work and do not know too much about the work life (i.e. challenges, tasks, deadlines, needs, etc.) of others and I behave according to this rule at work.	I rarely take the time to inform people about the work life details (i.e. challenges, tasks, deadlines, needs, etc.) of others in the unit (team) and rather keep this type of information private.	I actively make members aware of the details of the work life (i.e. challenges, tasks, deadlines, needs, etc.) of others in the unit (team) in order to facilitate better intra-group understanding and cooperation.	I try to see where there are opportunities at work to assist unit (team) members to get to know and understand each other's work life (i.e. challenges, tasks, deadlines, needs, etc.) better and use these to improve intra-group understanding.	I capitalise on all opportunities at work to assist unit (team) members get to know and understand each other's work life (i.e. challenges, tasks, deadlines, needs, etc.) on a very deep level.	<b>6</b>
<b>G4</b>	<b>Facilitating open debates</b>	I try to censor and actively discourage <i>open</i> debates in my unit (team).	I try to steer (new) debates in my unit (team) away from sensitive/controversial subjects and topics.	I sometimes stir debate in my unit (team) on a number of new interesting and relevant topics, even though these might be slightly sensitive or controversial at times.	I actively encourage everyone in our unit (team) to open up debate on various new important topics that are sometimes sensitive/controversial, but especially those that are constructive and in support of our unit's (team's) objectives and performance.	I actively encourage everyone in our unit (team) to talk about anything and everything with each other that are of relevance to us, and even invite healthy debate on controversial or taboo topics that have been never openly discussed before.	<b>6</b>

<b>G5</b>	<b>Work structuring</b>	I prefer to have individuals assigned to different, separate tasks that require little collaboration/ communication with others and try to structure my projects/assignments accordingly.	Sometimes I structure my projects around getting the contributions simply of individual role-players in isolation from others while at other times; I structure my projects so as to facilitate a little collaboration / communication between members in my unit (team).	Because of the way I believe work should be structured in satisfying people's socio-psychological needs, I structure most of the projects I manage so that at least some form of communication and collaboration are required between project participants.	I actively try to structure and organise work/tasks in my projects so that unit (team) members need to collaborate and communicate with each other to some extent.	I actively try to structure and organise work/tasks in my projects so that unit (team) members need to frequently collaborate and communicate with each other over extended periods of time.	<b>6</b>
<b>G6</b>	<b>Relationship building</b>	I am not able to build relationships between people in my unit (team) at all.	I struggle to get others to get to know each other and to get along with each other in my unit (team).	I connect people with similar backgrounds and interests to each other via mutual areas of concern and manage to build relationships in the unit (team) in this way.	I connect diverse people through events and by purposefully getting specific individuals assigned to projects, tasks, committees or workgroups and manage to build strong relationships in my unit (team).	I actively build bridges and forge strong relationships all over my unit (team) and between highly diverse people in my unit (team).	<b>6</b>
<b>G7</b>	<b>Leveraging diversity</b>	Despite some effort from my side, generational and cultural differences and stereotypes between members continue to prevail and breed conflict in my unit (team).	I am one of those that find it difficult to get people with generational and cultural differences to put these aside and bond together properly with others in my unit (team).	I have managed (or have contributed) to smooth out some of the main generational and cultural differences between members in my unit (team) leading to some people bonding with each other and me to a certain extent.	Due to my efforts, people from different backgrounds and generations understand each other better to such an extent that general/cultural value differences do not normally hamper the operational efficiency of the unit (team).	Because of my efforts, members from different generations and cultures have formed a special and unified bond in the unit (team) characterised by learning, cross-pollination, sharing and understanding.	<b>6</b>
<b>G8</b>	<b>Sense of belonging</b>	I have failed to create any sense of belonging for any of the diverse members of our unit (team).	I am one of those that fail to create a strong sense of belonging for any of the diverse members of our unit (team).	I have managed (or contributed) to create a sort of an in-group out of a diverse member population that satisfies peoples' need to belong to something bigger than themselves.	Greatly due to my efforts, members have not only become very attracted to our unit (team) as an entity itself but to most (if not all) of its members as well.	Through my actions and influence in standing up for others around me, I have managed to instil a strong sense of belonging for all members in our unit (team).	<b>6</b>
<b>G9</b>	<b>Cooperation and trust</b>	I am one of those that fail to get members to trust each other and to cooperate with each other fully in our unit (team).	I am one of those that struggle to get other members in our unit (team) to trust each other and to truly cooperate with each other.	I have managed to get (or contributed to) some of the more important members in our unit (team) to trust each other and to cooperate with each other at high levels of reciprocity.	I have managed to get (or greatly contributed to) most of the members in our unit (team) to trust each other and to generally work on a highly cooperative basis with each other.	Due to my efforts, purposeful relationships between diverse members have formed all across our unit (team) that are characterised by deep trust and strong cooperation.	<b>6</b>
<b>G10</b>	<b>Synergy</b>	I fail to get any synergistic interactions going between members in my unit (team).	I struggle to get synergistic interactions going between diverse members in my unit (team).	I have managed to get (or my efforts have contributed to) some of the more important members in our unit (team) to function synergistically as a collective.	I have managed to get (or my efforts have contributed to) most of the members in our unit (team) to function synergistically as a collective.	Due to my efforts, there exist great synergies between diverse members that affect significant process gains in my unit (team).	<b>6</b>

<b>H STRENGTHENS AND ENABLES FOLLOWERS: Raises the confidence and performance capabilities of followers towards success and high levels of achievement.</b>							
	<b>Definitions</b>	<b>Significant development area</b>	<b>Development area</b>	<b>On par/satisfactory</b>	<b>Strength</b>	<b>Well-developed strength</b>	<b>Cannot rate</b>
		<b>1</b>	<b>2</b>	<b>3</b>	<b>4</b>	<b>5</b>	
<b>H1</b>	<b>Problem-solving fundamentals</b>	I seldom if ever train my unit (team) to become better at problem solving at a collective level of competence.	At best, I only provide some tidbits of advice as to how my unit (team) can become better at solving problems at a collective level of competence.	I have had some good attempts at teaching my unit (team) to be more successful at problem solving at a collective level of competence but probably need some (more) practical experience in order to be able to do this effectively.	At times, I am successful at training my unit (team) to become better at problem-solving, fact-finding and solution generation.	I often and successfully train my unit (team) to become better at problem-identification, fact-finding and solution generation.	<b>6</b>
<b>H2</b>	<b>Coaching</b>	I leave others to sort out their personal performance problems by themselves.	I will only become involved in assisting others with their performance problems when they request my assistance explicitly and even then, I struggle to come up with practical solutions/strategies that work for them.	I sometimes provide others around me with some good advice and practical instruction as to how they could overcome current and future performance problems.	I often provide others around me with some practical advice and instruction as to how they could overcome current and future performance problems.	I am highly successful at teaching quite a number of individual unit (team) members around me to overcome any performance problems that they might have or that they might develop over the course of time.	<b>6</b>
<b>H3</b>	<b>Hope and optimism</b>	I do not manage to inspire hope and optimism about the future success of our unit (team) in others around me at all.	I struggle to inspire confidence and assurance about the future success of our unit (team) in others around me.	I generally have a positive outlook about the future success of our unit (team) that spill over to some of the colleagues around me.	I have an exceedingly optimistic outlook about the future success of our unit (team) and this belief rubs off on many of my colleagues at work.	I demonstrate unwavering hope and optimism about the future success of our unit (team) and my resilience in this regard rubs off on all of the members in the unit (team) around me.	<b>6</b>
<b>H4</b>	<b>Collective meta-cognition</b>	I seldom if ever teach my unit (team) how to self-reflect and <i>learn how to learn</i> at a collective level of competence.	At best, I only provide some tidbits of advice as to how my unit (team) can become better at <i>learning how to learn</i> at a collective level of competence.	I have had some good attempts at teaching my unit (team) how to become better at <i>learning how to learn</i> at a collective level of competence but probably need some (more) practical experience in order to be able to do this effectively.	At times, I am successful at training my unit (team) to self-reflect on their performance and <i>learn how to learn</i> at a collective level of competence.	I often and successfully teach my unit (team) to learn by themselves - i.e. to self-reflect and learn from procedures, tactics and operational choices by which they pursue objectives and challenging assignments.	<b>6</b>
<b>H5</b>	<b>Development</b>	I fail to provide any significant developmental assistance and advice to any of my colleagues at work at all.	I struggle to provide any colleagues at work with developmental assistance and advice of any real value.	I manage (or contribute) to grow the skills and experience base of certain individuals that I am close to in my unit (team) as is necessary for the (current and future) performance requirements of our unit (team).	I manage (or contribute) to grow the skills and experience base of even key individuals in my unit (team) as is necessary for the (current and future) performance requirements of our unit (team).	I successfully develop the bandwidth (i.e. portfolio of knowledge, experience and skills) of all of the individuals around me in line with the growth and future performance requirements of our unit (team).	<b>6</b>



<b>H6</b>	<b>Mentoring</b>	I really have not even managed to start to assist others around me in improving their personal and/or work life.	I have come up with some ideas for others around me on some constructive ways in which they can improve themselves (personally and at work), yet do not motivate or gain commitment from them to do so.	I have some good ideas in terms of what the areas are that certain colleagues could improve in (personally and at work) and utilise these to motivate some to set off on constructive journeys for such self-development to occur.	I provide some close colleagues in my unit (team) with sound career development objectives, model/suggest the appropriate developmental strategies to achieve these, and observe, motivate and record their progress towards these.	I provide the majority of members in my unit (team) with sound career development objectives, model/suggest the appropriate developmental strategies to achieve these, and observe, motivate and record colleagues' progress towards these.	<b>6</b>
<b>H7</b>	<b>Freethinking</b>	I cannot persuade nor inspire others around me to adopt a more freethinking, uninhibited approach when planning new assignments/projects at all.	I struggle to get others around me to adopt a more freethinking, uninhibited approach when planning new assignments/projects.	On occasion, I push my colleagues to come up with new, fresh ways of thinking about new projects and assignments but in general, we usually fall back on our proven, traditional ways of thinking.	More often than not, I get my unit (team) to move away from our traditional way of thinking when planning for the completion of new assignments/project.	I successfully encourage my unit (team) to routinely and uninhibitedly experiment with different perspectives, non-traditional thinking and different strategies to complete new assignments/projects.	<b>6</b>
<b>H8</b>	<b>Training</b>	I do not have the motivation nor the capacity to spare to physically train others around me how to improve their performance at work.	On occasion, I have talked some colleagues through ways of improving their performance at work but I do not follow through to ensure that they properly incorporate this advice at work.	I sometimes provide others around me with structured training and follow-ups on how they could overcome current and future performance problems and become more effective in their jobs.	I often provide others around me with structured training and follow-ups on how they could overcome current and future performance problems and become more effective in their jobs.	I capitalise on all possible opportunities to conduct in the on-the-job training of individuals around me by showing them what to do and giving them the opportunity to show that they can truly implement what I have taught them.	<b>6</b>
<b>H9</b>	<b>Succession</b>	I do not contribute to the development and preparation of the next generation of leaders, managers or supervisors in our unit (team) at all.	I sometimes play a small part in preparing and developing certain individuals for key roles that they have been earmarked for in the future.	I contribute as much to the preparation and development of individuals that are earmarked for more senior/critical roles in the future as the average member in our unit (team).	Due to my efforts, planning and hard work, my unit (team) has competent successors available for some of the more critical positions that differentiate our unit (team) as a top service/product provider from our competitors.	Due to my efforts, planning and hard work, we have competent successors available for all of the critical positions that differentiate our unit (team) as a top service/product provider for customers from our competitors.	<b>6</b>
<b>H10</b>	<b>Collective self-efficacy</b>	I cannot seem to get others around me to believe that our unit (team) as a collective is capable of achieving extraordinary performance results and objectives at all.	I struggle to get others around me to believe that our unit (team) as a collective is capable of achieving extraordinary performance results and objectives.	I manage to get some of the more important role-players to buy-into the idea that our unit (team) as a collective is capable of achieving extraordinary performance results and objectives.	I manage to get the majority of our people to buy-into the idea that our unit (team) as a collective is capable of achieving extraordinary performance results and objectives.	I grow and fortify everyone's beliefs in our unit (team) that we are capable of extraordinary heights and levels of performance.	<b>6</b>

<b>I MANAGES THE INTERNAL WORK UNIT ENVIRONMENT: Maintains a hands-off procedural view and executes in-process corrections as and when required to ensure that different components of the conversion process keep pulling in the same direction.</b>							
	<b>Definitions</b>	<b>Significant development area</b>	<b>Development area</b>	<b>On par/satisfactory</b>	<b>Strength</b>	<b>Well-developed strength</b>	<b>Cannot rate</b>
		<b>1</b>	<b>2</b>	<b>3</b>	<b>4</b>	<b>5</b>	
<b>I1</b>	<b>Work speed regulation</b>	I do not even know where to start if I was asked to regulate the work speed of different individuals/teams in order to ensure on-time product/service delivery in our unit (team).	I am not (yet) competent at regulating the work speed of different individuals/teams in order to ensure on-time product/service delivery in our unit (team).	I am able to regulate the work speed of different individuals/teams that are part of the different components of our unit's (team's) conversion process so as to ensure on-time product/service delivery.	I am quite astute at regulating the work speed of different individuals/teams that are part of the different components of our unit's (team's) conversion process so as to ensure on-time product/service delivery.	I am an expert at regulating the work speed of different individuals/teams that are part of the different components of our unit's (team's) conversion process so as to ensure on-time product/service delivery.	<b>6</b>
<b>I2</b>	<b>Balancing material resources</b>	I do not even know where to start if I was asked to shift critical material resources between different components of our unit's (team's) conversion process in order to counter unforeseen stoppages/problems that may arise suddenly throughout the unit (team).	I am not (yet) competent at shifting critical resources between different components of our unit's (team's) conversion process in order to counter unforeseen stoppages/problems that may arise throughout the unit (team).	I am able to adequately shift critical material resources between different components of our unit's (team's) conversion process in order to counter unforeseen stoppages/problems that may arise in certain areas of the unit (team).	I am quite astute at shifting critical material resources between different components of our unit's (team's) conversion process in order to counter unforeseen stoppages/problems that may arise in certain areas of the unit (team).	I am an expert at shifting critical material resources between different components of our unit's (team's) conversion process in order to counter unforeseen stoppages/problems that may arise in certain areas of the unit (team).	<b>6</b>
<b>I3</b>	<b>Balancing human resources</b>	I do not even know where to start if I was asked to shift human resources between different components of our unit's (team's) conversion process in order to counter unforeseen stoppages/problems that may arise suddenly throughout the unit (team).	I am not (yet) competent at shifting human resources between different components of our unit's (team's) conversion process in order to counter unforeseen stoppages/problems that may arise throughout the unit (team).	I am able to adequately shift human resources between different components of the unit's (team's) conversion process in order to counter unforeseen stoppages/problems that may arise in certain areas of the unit (team).	I am quite astute at shifting human resources between different components of our unit's (team's) conversion process in order to counter unforeseen stoppages/problems that may arise in certain areas of the unit (team).	I am an expert at shifting human resources between different components of our unit's (team's) conversion process in order to counter unforeseen stoppages/problems that may arise in certain areas of the unit (team).	<b>6</b>
<b>I4</b>	<b>Quality assurance</b>	I do not even know where to start if I was asked to manage and quality assure our unit's (team's) conversion process so as to ensure the optimal delivery speed, quality and cost-efficiency of our unit's (team's) products/services.	I am not (yet) competent at quality assuring the unit's (team's) conversion process so as to ensure the optimal delivery speed, quality and cost-efficiency of our unit's (team's) products/services.	I am able to adequately manage our unit's (team's) conversion process so as to ensure the optimal delivery speed, quality and cost-efficiency of our unit's (team's) products/services.	I am quite astute at managing our unit's (team's) conversion process so as to ensure the optimal delivery speed, quality and cost-efficiency of our unit's products/services.	I am able to expertly "orchestrate" our unit's conversion process so as to ensure the optimal delivery speed, quality and cost-efficiency of our unit's (team's) products/services.	<b>6</b>

15	<b>Correcting faults</b>	If you would ask me to identify and correct any (surfacing) faults in my unit's (team's) conversion process, I would not even know where to start looking.	I am not (yet) fully competent at identifying and correcting any (surfacing) faults in my unit's (team's) conversion process.	I am capable of identifying and correcting faults in my unit's (team's) conversion process in real-time.	I am quite astute at identifying and correct faults in my unit's (team's) conversion process in real-time.	I am an expert in identifying and correcting faults in my unit's (team's) conversion process in real-time.	6
16	<b>Managing risk</b>	If you would ask me to adapt in real-time and manage surfacing risk in my unit's (team's) conversion process I would not know where to start.	I am not (yet) fully competent at adaptation and the management of surfacing risk in my unit's (team's) conversion process.	I am relatively competent at adaptation and the management of surfacing risk in my unit's (team's) conversion process.	I am astute at adaptation and the management of surfacing risk in my unit's (team's) conversion process.	I am highly competent at adaptation and the management of surfacing risk in my unit's (team's) conversion process.	6
17	<b>Process adaptation</b>	If you had to ask me to make recalibrations to the performance process of my unit (team) and implement short-term solutions to ensure the successful completion of a current performance cycle in real-time I would not know where to start.	I am not (yet) competent at making recalibrations to the performance process of my unit (team) and implementing short-term solutions to ensure the successful completion of a current performance cycle in real-time.	I am relatively competent at making recalibrations to the performance process of my unit (team) and implementing short-term solutions to ensure the successful completion of a current performance cycle in real-time.	I am astute at making recalibrations to the performance process of my unit (team) and implementing short-term solutions to ensure the successful completion of a current performance cycle in real-time.	I am an expert at making recalibrations to the performance process of my unit (team) and implementing short-term solutions to ensure the successful completion of a current performance cycle in real-time.	6
18	<b>Component integration</b>	If you had to ask me to integrate disparate and differentiated workflow actions/component in concert with the necessary temporal pacing in order to ensure on-time product/service delivery in my unit (team) I will not know where to start.	I am not (yet) competent at integrating disparate and differentiated workflow actions/components in concert with the necessary temporal pacing in order to ensure on-time product/service delivery in my unit (team).	Under normal conditions, I am capable of integrating disparate and differentiated workflow actions/components in concert with the necessary temporal pacing in order to ensure on-time product/service delivery in my unit (team).	Under most conditions, I am astute at integrating disparate and differentiated workflow actions/components in concert with temporal pacing in order to ensure on-time product/service delivery in my unit (team).	I am an expert at integrating disparate and differentiated workflow actions/components in concert with the necessary temporal pacing in order to ensure on-time product/service delivery in my unit (team).	6
19	<b>Experiential learning</b>	If you had to ask me to verbalise and coach others on the reasons for why coordination broke down in a specific performance cycle I would now where to start.	I am not (yet) competent at analysing the reasons for why coordination broke down in a performance cycle and at coaching others how to avoid the same pitfalls in future.	I am capable of analysing the reasons for why coordination broke down in a performance cycle and coaching others how to avoid the same pitfalls in future.	I am astute at analysing the reasons for why coordination broke down in a performance cycle and coaching others how to avoid the same pitfalls in future.	I am an expert at analysing breakdowns in coordination in the unit (team) and utilising reasons for coordination breakdown as part of an <i>experiential learning experience</i> to others.	
110	<b>Situational updates</b>	I do not ever provide situational updates (i.e. how effectively and efficiently the current performance cycle is operating) to other members in my unit (team).	I rarely provide situational updates (i.e. how effectively and efficiently the current performance cycle is operating) to other members in my unit (team).	I provide situational updates (i.e. how effectively and efficiently the current performance cycle is operating) to other members in my unit (team), but mostly only when things are going as planned.	I regularly provide situational updates (i.e. how effectively and efficiently the current performance cycle is operating) to other members in my unit (team), even when things are not going as planned.	I provide continuous situational updates (i.e. how effectively and efficiently the current performance cycle is operating) to other members in my unit (team) under all conditions.	

## **APPENDIX B**

### **PIENAAR GRADUATE LEADER COMPETENCY QUESTIONNAIRE**

#### **[PGLCQ] – OTHER-RATER VERSION**

## CONSENT TO PARTICIPATE IN RESEARCH

Dear prospective research participant

### **The development and psychometric evaluation of a graduate leader competency questionnaire**

My name is Jacques Pienaar, a student at the Department of Industrial Psychology at the University of Stellenbosch, and I would like to invite you to take part in a study, the results of which will contribute to a research project in order for me to complete my PhD dissertation. Please take some time to read the information presented here, which will explain the details of this project. Please note that your participation is entirely voluntary and you are free to decline to participate. If you say no, this will not affect you negatively in any way whatsoever. You are also free to withdraw from the study at any point, even if you do agree to take part in the study now. To do so you simply have to close the browser whilst completing the survey. The purpose of the study is to develop an instrument for measuring graduate (leader-in-training) performance. It is anticipated that the results of my research will not only be valuable for academic reasons, but also for your company and their graduate (recruitment and development) initiatives. This is a step towards gathering more information on complex human behaviour and especially the reasons for why graduate (leader) performance varies. Understanding this type of behaviour could contribute to identifying and developing the next generation of graduate leaders.

I am asking graduates (leaders-in-training) to rate themselves on a number of different competencies that are deemed to be crucial in becoming high performance leaders. The questionnaire will be distributed on an on-line format (similar to this link that you have received) and resembles a sort of an informal performance review. As a direct manager or supervisor to one or more of these graduates, you are also requested to rate these graduates on these same competencies. The name of the graduate you will be rating and that have also consented to participate in this study along with you was provided in the e-mail in which I forwarded this link to you. Depending on your role in the organization and the number of graduates you have reporting to you, this might also mean that you could be rating more than one graduate as part of this study. If this is the case, more links like this one will be sent to your mail address with the identities of the other graduate trainees you will also be required to rate. If you consent to participate, please treat this as a formal performance review exercise where you will be rating one or more of your graduates. Although you will not be rating graduate **output performance in his or her job** per se, the questionnaire will ask you to rate how well they demonstrate certain competencies at work that is believed to have an influence on their future success as leaders in the business. However, and even though you must please treat this as a formal performance review, I want to assure you that your responses as well as the self-ratings of the graduates that you will be rating will be kept strictly confidential and that it will **not be used for this purpose of a formal performance review**. In other words, your ratings will not have an influence on the careers or financial remuneration or increases of the graduates that you assess, and it will be used purely for research purposes.

**RIGHTS OF RESEARCH PARTICIPANTS:**

You have the right to decline answering any questions and you can exit the questionnaire at any time without giving a reason. You are not waiving any legal claims, rights or remedies because of your participation in this research study. If you have questions regarding your rights as a research participant, contact Mrs Maléne Fouché [[mfouche@sun.ac.za](mailto:mfouche@sun.ac.za); 021 808 4622] at the Division for Research Development at Stellenbosch University.

Except for myself, only my supervisor will have access to the questionnaire data and my records of your answers. I will not include your personal information in these records that I store in the data file. The data file will also be kept secure on a password-protected computer. Only aggregated statistics of your recoded responses (along with that of others) will be reported and disseminated. The identities of participants will never be revealed. The identity of participating organisations will also not be revealed. If you have any questions or concerns about the research, please feel free to contact Jacques Pienaar (083 236 4108 or [jacquespienaarorama@gmail.com](mailto:jacquespienaarorama@gmail.com)) or Prof Callie Theron of the Department of Industrial Psychology at Stellenbosch University (084 273 4139 or [ccth@sun.ac.za](mailto:ccth@sun.ac.za)). Please save a copy of this form on your computer for future referral.

I confirm that I have read and understood the information provided.

YES NO

I agree to take part in this online performance questionnaire.

YES NO

## OVERVIEW

### 4. INTRODUCTION

Graduate leadership performance is defined as a network of structural relations existing between an inter-related set of latent behavioural performance dimensions and an interrelated set of latent outcome variables valued by the organisation. The questionnaire attempts to assess the level of competence that graduate leaders display on the latent behavioural graduate leadership performance dimensions. Your ratings, along with other respondent ratings, will be used to determine the suitability of questionnaire items as well as the overall performance rating to measure graduate leaders' performance. The questionnaire will help to assess which dimensions of graduate leadership performance graduates do well on and on which dimensions performance could be improved. This could provide valuable formative feedback during the graduate development programme.

### 5. INSTRUCTIONS

The other-rater version of the Pienaar Graduate Leader Competency Questionnaire (PGLCQ) consists of 90 items measuring nine dimensions. The questionnaire requires you to rate the graduate(s) that have been assigned to you from a supervisory or managerial perspective, thus you

need to evaluate one or more graduates (leaders-in-training) that is or are working under you or that has or have worked under you in the recent past.

- Please read each item carefully and choose the appropriate response (1-5) that best describes the graduate (leader-in-training's) behaviour **over the past 12 months** for that specific dimension.
- Make a (X) over the corresponding score value.
- Do not over-think your answers and rate the graduate (leader-in-training) according to your initial response.
- Completion of the PGLCQ for a graduate would take about 25 minutes.
- The questionnaire consists of two sections, Section A - Biographical Information, Section B– PGLCQ.
- All questions must be answered as honestly as possible.

## 6. EXAMPLE

In your response to items comprising each subscale you should indicate to what extent the graduate (leader-in-training) you are rating displayed the specified behaviour over a 12-month period that best describes his or her standing on the specific behavioural graduate leadership performance dimension, such as *ANALYSES AND UNDERSTANDS THE EXTERNAL AND INTERNAL WORK UNIT ENVIRONMENT* for example. If *Environmental scanning* is taken as an example of behaviour in which the latent performance dimension *ANALYSES AND UNDERSTANDS THE EXTERNAL AND INTERNAL WORK UNIT ENVIRONMENT* expresses itself and let's say if the graduate rarely scanned the environment in which your unit (team) operates and most competitive intelligence he or she gathers was obtained purely by chance over the last 12 months, the response option 1 should be selected by placing a cross in the box (over the text) below the appropriate number (see example below). If, however, the graduate has conducted a thorough review of the environment (i.e. industry, market, customer needs, actual place of work, governmental regulations, etc.) in which your unit (team) operates at least 4 times **over the past 12-month period**, the "strength" option should be marked by placing a cross in the box (over the text) below the appropriate number. **Please use the whole scale.** Options 2 and 4 also constitute permissible response options even though they have no behavioural anchors. Response option 6 (cannot rate) should be used as seldom as possible and only if insufficient evidence is available to provide a valid rating.

<b>B</b>	<b>ANALYSES AND UNDERSTANDS THE EXTERNAL AND INTERNAL WORK UNIT ENVIRONMENT: Systematically surveys and immerses self in the internal and external environment of the unit (team) to collect and interpret information about critical occurrences or conditions on behalf of the unit (team) as input to unit (team) performance planning.</b>						
	<b>Denotations</b>	<b>Significant development area 1</b>	<b>Development area 2</b>	<b>On par/satisfactory 3</b>	<b>Strength 4</b>	<b>Well-developed strength 5</b>	<b>Cannot rate 6</b>
<b>B1</b>	<b>Environmental scanning</b>	He/she rarely scans the environment in which our unit (team) operates and most competitive intelligence he/she gathers is obtained purely by chance.	He/she does make an effort to collect information on conditions/events/occurrences that can influence the unit's (team's) performance, but only when high profile, macro events/changes occur and are reported in the media that prompts him/her to do so.	As a rule, he/she conducts a thorough review of the environment (i.e. industry, market, customer needs, actual place of work, governmental regulations, etc.) in which our unit (team) operates on a half-yearly basis.	He/she conducts a thorough review of the environment (i.e. industry, market, customer needs, actual place of work, governmental regulations, etc.) in which our unit (team) operates at least 4 times a year.	He/she systematically immerses him/herself and thoroughly surveys the environment (i.e. industry, market, customer needs, actual place of work, governmental regulations, etc.) in which our unit (team) operates on a continuous basis.	<b>6</b>



## SECTION A BIOGRAPHICAL INFORMATION

Please complete the biographical section by either making an "X" in the appropriate column or filling in text where required. The information is necessary for to characterise the sample in the research study.

A1	<b>Identity</b>	<b>Please specify the name and surname of the graduate you are rating</b>													
A2	<b>Age</b>	<b>Please specify your age years</b>													
A3	<b>Your experience in managing others</b>	<b>1</b>			<b>2</b>			<b>3</b>			<b>4</b>				
		No significant experience (0-1 year)			Some experience (2-5 years)			Good experience (6-9 years)			Highly experienced (10 years+)				
A4	<b>Your area of expertise</b>	<b>1</b>		<b>2</b>		<b>3</b>		<b>4</b>		<b>5</b>		<b>6</b>		<b>7</b>	
		Accounting		Commerce		Engineering		Logistics/Transport		Social Sciences		Health Sciences		Other (please specify)	
A5	<b>Your home language</b>	<b>1</b>	<b>2</b>	<b>3</b>	<b>4</b>	<b>5</b>		<b>6</b>	<b>7</b>	<b>8</b>	<b>9</b>	<b>10</b>	<b>11</b>	<b>12</b>	
		Afrikaans	English	Ndebele	Northern Sotho	Sotho		Swazi	Tsonga	Tswana	Venda	Xhosa	Zulu	Other	
A6	<b>Your gender</b>	<b>1</b>						<b>2</b>							
		Male						Female							
A7	<b>Your race</b>	<b>1</b>		<b>2</b>		<b>3</b>			<b>4</b>		<b>5</b>		<b>6</b>		
		Asian		Black African		Coloured			Indian		White		Other		
A8	<b>Your geographic location</b>	<b>Please specify the province and town/city where you reside/work</b>													
A9	<b>The industry in which you work</b>	<b>1</b>	<b>2</b>	<b>3</b>	<b>4</b>	<b>5</b>	<b>6</b>	<b>7</b>	<b>8</b>	<b>9</b>	<b>10</b>	<b>11</b>	<b>12</b>		
		Banking	Retail	Energy	Media	Mining	Tech	Capital	Manufacturing	Logistics	Consulting	Research	Other		

## SECTION B PGLCQ

Please complete the PGLCQ section by making an “X” in the appropriate column. Please use the “cannot rate response option” as seldom as possible.

<b>A PERSONAL LEADER PROFICIENCY: Functions as a well-rounded, sought-after and high impact resource in my unit (team)</b>							
	Denotations	Significant development area	Development area	On par/satisfactory	Strength	Well-developed strength	Cannot rate
		1	2	3	4	5	6
<b>A1</b>	<b>Personal performance contribution</b>	He/she consistently struggles to make any significant personal contributions to the unit/team's performance outcomes.	He/she consistently makes below average personal contributions to the performance outcomes of the unit (team).	He/she consistently contributes at least as much to the team/unit's performance outcomes as the average member in it.	He/she consistently makes above average personal contributions to the performance outcomes of the unit (team).	He/she consistently makes significant personal contributions to the unit/team's performance outcomes.	<b>6</b>
<b>A2</b>	<b>Reputation for adding value</b>	He/she is routinely overlooked and not asked to become involved and contribute when ad-hoc projects arise that do not fall within the scope of his/her normal daily duties.	Usually, he/she is not asked to contribute his/her personal expertise and experience to projects that fall outside of the scope of his/her normal duties at work.	In areas of personal expertise and experience, he/she is often asked to become involved in projects that fall outside the scope of his/her normal duties at work.	Even if not in areas of personal expertise and experience, he/she is sometimes asked to contribute to projects that fall outside the scope of his/her normal duties at work.	He/she is routinely asked to become involved in all projects that do not fall within the scope of his/her normal duties at work, whether he/she has experience (or a background) in dealing with the issue at hand or not.	<b>6</b>
<b>A3</b>	<b>Perceived competence</b>	When tasked with a particularly challenging project, others quickly move in to try to cover for his/her perceived weaknesses.	Others often try to shield him/her from tough situations and challenging assignments.	Others regard him/her in the unit (team) as a contributor that can hold his/her own in relatively tough assignments and situations.	Others regard him/her in the unit (team) as a highly competent and tough contributor, even in challenging situations.	Even under extreme pressure, his/her presence makes others feel completely calm, that they are in charge of the performance process and have things under control.	<b>6</b>
<b>A4</b>	<b>Team dynamics</b>	I think the members of the unit (team) can be effective in what they do whether he/she is there to support them in their efforts or not.	Sometimes I feel I that his/her presence is required for the unit (team) to perform, whilst at other times I do not.	He/she consistently seems to be part of the glue that holds the unit (team) together and makes the required performance possible there.	Other members regard him/her as a very important cog in the unit's (team) 'performance wheel'.	Other members and myself regard him/her as indispensable to the unit's (team) performance equation.	<b>6</b>
<b>A5</b>	<b>Intellectual impact</b>	He/she almost never seems to make the right decisions in a timely manner and have no real ideas for adding value to the unit (team).	His/her decision-making quality and timing needs some work and he/she struggles to contribute ideas of any real value to the unit (team).	Sometimes he/she makes great/timely decisions and contributes some great ideas that improve the performance of my unit (team).	More often than not, his/her decision-making is sound/timely and his/her ideas contribute to performance improvement in the unit (team).	He/she consistently and efficiently makes good decisions and contributes ideas that enhance the unit's (team) performance.	<b>6</b>

	Denotations	Significant development area	Development area	On par/satisfactory	Strength	Well-developed strength	Cannot rate
		1	2	3	4	5	6
<b>A6</b>	<b>Retrenchment pecking-order</b>	If the company is struggling financially and had to let people go, I think he/she would be in the first group that would be retrenched.	If the company is struggling financially and had to let people go, he/she would be one of the borderline cases that would be lucky to keep his/her job.	He/she probably would have a slightly better chance than the average organisational member to keep his/her job when lay-offs are imminent.	He/she is part of what makes the organisation tick so he/she would be relatively safe if a part of the workforce had to be retrenched.	I think that when retrenchments are imminent, he/she would be one of the last people that the company would want to let go.	<b>6</b>
<b>A7</b>	<b>Project team/group selection popularity</b>	More often than not, he/she is the last person to be picked onto a newly formed task/project group in the unit (team).	He/she is usually a second round pick for selection onto a newly formed task/project group in the unit (team).	He/she is usually picked somewhere during the first round of selection for a newly formed task/project group in the unit (team).	He/she is usually among the first two picks for selection onto a newly formed task/project group in the unit (team).	He/she is usually the first person to be selected onto a task/project group in the unit (team).	<b>6</b>
<b>A8</b>	<b>Collective performance</b>	He/she really struggles to get others around him/her to work with each other and him/her for the collective to perform better.	He/she cannot seem to get the majority of people around him/her to work with each other and him/her to perform better.	His/her performance at work in terms of how he/she gets others around him/her to work together and with him/her to improve performance is adequate.	He/she tends to get things done and take others along with him/her in doing so.	He/she achieves extremely challenging performance objectives and takes others along with him/her in doing so.	
<b>A9</b>	<b>Influence of opinion</b>	His/her opinion is rarely consulted nor acknowledged by others in the unit (team).	Sometimes, members he/she is close to in the unit (team) would ask him/her for advice on a variety of matters.	His/her opinion on various matters are often consulted and the significance thereof acknowledged by the people around him/her.	His/her opinion matters greatly to others and is often used as the basis for exploring solutions to problems in the unit (team).	His/her opinion is highly sought after, and he/she easily gets buy-in to make tough decisions to improve the unit (team).	<b>6</b>
<b>A10</b>	<b>Collaboration</b>	Most people do not really enjoy working with him/her on projects/assignments.	The experience of working with him/her could be a good experience for specific types of people.	In general, he/she makes effort with people and gets along well with others he/she works with on different assignments/projects.	People who he/she works with walks away from time spent with him/her with a positive experience.	People describe the experience of working with him/her as thoroughly pleasurable, extremely exciting and highly constructive.	<b>6</b>

	Denotations	Significant development area	Development area	On par/satisfactory	Strength	Well-developed strength	Cannot rate
		1	2	3	4	5	6
<b>B</b>	<b>ANALYSES AND UNDERSTANDS THE EXTERNAL AND INTERNAL WORK UNIT ENVIRONMENT: Systematically surveys and immerses self in the internal and external environment of the unit (team) to collect and interpret information about critical occurrences or conditions on behalf of the unit (team) as input to unit (team) performance planning.</b>						
<b>B1</b>	<b>Environmental scanning</b>	He/she rarely scans the environment in which the unit (team) operates and most competitive intelligence he/she gathers is obtained purely by chance.	He/she makes an effort to collect information on conditions/events/occurrences that can influence the unit's (team's) performance, but only when high profile, macro events/changes occur and are reported in the media that prompts him/her to do so.	As a rule, he/she conducts a thorough review of the environment (i.e. industry, market, customer needs, actual place of work, governmental regulations, etc.) in which the unit (team) operates on a half-yearly basis.	He/she conducts a thorough review of the environment (i.e. industry, market, customer needs, actual place of work, governmental regulations, etc.) in which the unit (team) operates at least 4 times a year.	He/she systematically immerses him/herself and thoroughly surveys the environment (i.e. industry, market, customer needs, actual place of work, governmental regulations, etc.) in which the unit (team) operates on a continuous basis.	<b>6</b>
<b>B2</b>	<b>Information dissemination</b>	He/she rarely if ever extracts, interprets and disseminates vital environmental analytics for the unit (team).	He/she extracts and disseminates vital environmental analytics for the unit (team) but do so mostly at a superficial level and often only when prompted to do so.	He/she extracts and disseminates vital analytics for the unit (team), sometimes even at a sophisticated level of analysis, but can be more proactive in doing so.	As a rule, he/she manages to convey the most important implications/repercussions of pertinent environmental analytics to the unit (team) as and when new information becomes available.	He/she reactively and proactively extracts, expertly interprets and comprehensively disseminates all relevant and vital environmental analytics for the unit (team) on a continuous basis.	<b>6</b>
<b>B3</b>	<b>Competitive intelligence</b>	He/she does not really know where to start looking for information about the operational environment that could provide the unit (team) with an advantage over the opposition.	He/she manages to extract some information about the operational environment to affect small improvements in the unit's (team's) performance.	Usually, the information that he/she extracts and shares with the unit (team) puts us on par with the competitiveness levels of the opposition.	The information he/she extracts from the operational environment provides the unit (team) with a competitive edge over the opposition.	He/she extracts, shares and utilises information about the environment in which the unit (team) operates in order to make the unit (team) the leader in the market/industry in which we operate.	<b>6</b>
<b>B4</b>	<b>Information processing</b>	The pure magnitude of the information that could affect the unit's (team's) performance and that is available to him/her in the environment is confusing to him/her and prevents him/her from extracting any meaningful competitive intelligence.	He/she can make some sense of the bewildering amount of information that is available in the environment and that can impact the unit's (team's) performance but it takes him/her a considerable amount of time to do so.	He/she is competent at deducing the implications/repercussions for the unit's (team's) functioning from a magnitude of information available in the environment quite quickly but may at times oversee the extremely complex, 'veiled' signals and messages hidden there.	He/she has mastered the ability to quickly make sense out of a (even complex) magnitude of different information sources in the environment but sometimes may struggle to do so when the market is highly chaotic and unstable.	He/she can quickly cut through the bewildering array of environmental information available, even in an unstable/chaotic market to identify critical occurrences/conditions that may have an impact on the unit's (team's) functioning.	<b>6</b>

	Denotations	Significant development area	Development area	On par/satisfactory	Strength	Well-developed strength	Cannot rate
		1	2	3	4	5	6
B5	<b>Situational awareness</b>	He/she struggles to stay abreast of changing conditions/occurrences that have a direct effect on the unit's (team's) ability to compete optimally.	He/she is sometimes able to spot changes in the more obvious conditions in the market that have a direct effect on the unit's (team's) ability to compete optimally.	He/she is reasonably good at identifying changes in the more obvious market conditions that have a direct effect on the unit's (team's) ability to compete optimally and usually acts on this information in time.	He/she is quite astute at identifying changes in both the more obvious and complicated market conditions that have a direct effect on the unit's (team's) ability to compete optimally and usually acts on this information in time.	Through his/her monitoring of the environment, the unit (team) is continuously aware of almost all the possible changing conditions/occurrences in the environment that have a direct effect on its ability to compete optimally.	6
B6	<b>Awareness of internal capability</b>	He/she is somewhat ignorant of the entire unit's (team's) talent profile (i.e. capabilities, strengths, weaknesses, skills, qualifications, etc.).	He/she is informed only on the more important, high-level details of the entire unit's (team's) talent profile (i.e. qualifications, experience).	He/she has a reasonably thorough understanding of the talent profile of the unit's (team's) core, senior members but less so with regards to new or junior members whose profiles he/she is only familiar with at a superficial level.	He/she has a decent and thorough understanding of the entire unit's (team's) talent profile and makes an effort to keep updated on changes, improvements or downgrades that occur in this area.	At any point in time, he/she has a deep, penetrating understanding of the unit's (team's) talent profile.	6
B7	<b>Future trends</b>	He/she fails to spot trends in the market that can affect the performance levels of the unit (team) in the future.	At best, he/she can sometimes spot macro level trends in the environment that may affect the performance of the unit (team) in the future.	He is usually aware of all of the more obvious trends/opportunities that may affect the performance of the unit (team) in the future.	He/she is usually aware of obvious and even hidden (veiled) trends in the environment that may affect the performance of the unit (team) in the future.	He/she has the knack of "spotting" overt as well as veiled trends/opportunities/threats that will affect the unit (team), sometimes even before they actually occur.	6
B8	<b>Operational efficiency awareness</b>	He/she is entirely in the dark when it comes to the operational efficiency of the unit (team).	He/she is somewhat removed from the on-going operational efficiency of the unit (team).	He/she only monitors certain high-level aspects of the unit's (team's) operational efficiency on a daily basis (i.e. project deadlines, output) so that he/she can maintain a helicopter view of how the unit (team) is performing.	He/she regularly monitors the detail of the operational efficiency of the unit (team).	At any given point in time, he/she can provide accurate and in-depth information on the current operational efficiency of the unit (team).	6
B9	<b>Social capital utilisation</b>	He/she does not really have (or is not able to utilise) contacts, friends and colleagues who can assist him/her when trying to extract information that are pertinent to the unit's (team's) current and future operational performance.	He/she rarely utilises contacts, friends and colleagues to extract information from them that are pertinent to the unit's (team's) current and future operational performance.	He/she gains insights/knowledge/information from my friends, colleagues, contacts and the people who he/she engages with at important, yet infrequent events that are pertinent to the unit's (team's) current and future operational performance.	He/she stays in reasonably regular contact with friends, contacts, colleagues and other people in order to extract information from them that are pertinent to the unit's (team's) current and future operational performance.	He/she regularly gains insights/knowledge/information from friends, colleagues, contacts and the people he/she engages with on a daily basis that are pertinent to the unit's (team's) current and future operational performance.	6

<b>B10</b>	<b>Timeliness of information sharing</b>	He/she acquires/shares competitive intelligence much too late for others in the unit (team) to be able to capitalise on this information.	Sometimes he/she manages to share competitive intelligence to others in the unit (team) to capitalise on this information, while at other times, delays from his/her side results in opportunities slipping through our fingers.	He/she manages to share the most important parts of competitive intelligence to the unit (team) in order for them to capitalise on this information, more often than not.	He/she almost always manages to share the most important parts of competitive intelligence to the unit (team) in order for them to capitalise on this information.	He/she always shares all forms of competitive intelligence on time in order for others in the unit (team) to capitalise on all windows of opportunity that comes our way.	<b>6</b>
------------	--	---	--	---	--	---	----------

<b>C CREATES AN EXCITING AND ASPIRATIONAL VISION FOR THE UNIT: Attracts and rallies a wide follower base towards and inspiring and exciting vision of what can be achieved and how their lives can be fulfilled and become more meaningful by investing in such a cause.</b>							
<i>*Note: Vision in this context can refer to a formal or informal future end-state that the graduate (leader in training) either explicitly expresses for the collective and strives towards along with the unit (team) or (even implicitly) strives towards and demonstrates allegiance to by way of his/her own personal capacity and conduct at work.</i>							
	<b>Denotations</b>	<b>Significant development area</b>	<b>Development area</b>	<b>On par/satisfactory</b>	<b>Strength</b>	<b>Well-developed strength</b>	<b>Cannot rate</b>
		<b>1</b>	<b>2</b>	<b>3</b>	<b>4</b>	<b>5</b>	
<b>C1</b>	<b>Captivating cause</b>	He/she struggles to captivate others around him/her with a vision of a desirable future, an end-state of where we are going and what we can work towards.	He/she has managed to enthrall a few of the members in my unit (team) with a vision of a desirable future of what we can work towards but not the majority.	His/her vision of where we could be going and what we can be working towards has created a tipping point for collective action.	His/her vision for the future and the message behind it has captivated the majority but not all of the members of the unit (team).	His/her vision of where we could be going to and what we can be working towards has captivated the hearts and minds of almost all the members of the unit (team).	<b>6</b>
<b>C2</b>	<b>Member attraction</b>	The vision he/she articulates and works towards fails to attract any additional members to this cause.	The vision he/she articulates and works towards fails to attract any significant amount of additional members to this cause.	The vision that he/she articulates and works towards has attracted a few people to this cause.	Quite a number of new members have joined the cause that he/she has articulated and work towards this vision at work.	People respond to his/her way of thinking about the future and the vision that he/she has articulated and that he/she works towards has 'infected' many others to join and gravitate towards this cause.	<b>6</b>
<b>C3</b>	<b>Member ambition</b>	The cause that he/she has articulated and works towards seems to be limiting and constraining unit (team) member ambitions and dreams, rather than growing them.	Since he/she has communicated and started working towards a vision, unit (team) member ambitions and dreams have remained largely the same as before.	Since he/she has communicated and started working towards a vision, the ambitions and dreams of unit (team) members have expanded and grown to a certain extent towards this.	The vision that he/she has articulated and work towards has greatly increased the ambitions and dreams of the average unit (team) member.	He/she has stretched the unit (team) member's ambitions and dreams by describing to them and demonstrating an allegiance to a valued, future end-state as a highly attractive alternative to the current (and dreary) status quo.	<b>6</b>
<b>C4</b>	<b>Member confidence</b>	Nobody in my unit (team) believes that the vision that he/she has articulated and work towards is actually attainable.	The majority of the unit (team) seems to be sceptical about the possibility of attaining the vision that he/she has articulated and that he/she is working towards.	The cause that he/she has communicated and that he/she is working towards convinces some important unit (team) members that this vision is not only a pipe dream but that it is in fact, attainable and possible.	In the process of articulating and working towards a vision, he/she has actually raised the self-confidence of the majority of the unit (team) members in addition to convincing them of its viability.	He/she has utilised a desired future state of what we can become as a rhetorical device through which to persuade and raise the levels of confidence in almost all unit (team) members that this vision is realistic and attainable.	<b>6</b>
<b>C5</b>	<b>Identification with the cause</b>	Nobody in my unit (team) or outside it seems to genuinely identify with the vision that he/she has articulated and that he/she is working towards.	Some unit (team) members (and outsiders) have identified with the cause that he/she has articulated and that he/she is working towards voluntarily and easily while others seem to experience negative tension to conform and simply comply/align with this cause on a superficial level.	In general, the desired future that he/she has articulated and that he/she is working towards is met quite well and unit members voluntarily attempt to align with the ideals implied by it.	In general, the desired future that he/she has articulated and that he/she is working towards is met quite well and even some outsiders spontaneously align with the ideals implied by it.	He/she has created a desired future in the minds of almost all of the unit's (team) members that creates a positive tension for identity transformation to occur within them (and parties external to the organisation) in aligning with his/her ideal(s).	<b>6</b>

<b>C6</b>	<b>Aspirational cause</b>	Almost nobody in the unit (team) seems to be genuinely excited about the direction that he/she has mapped out and almost nobody demonstrate allegiance to it.	The vision that he/she has articulated and that he/she is working towards fails to excite the majority of the unit's members and is not aspirational enough for the collective to move forward or align with it.	Because of the vision that he/she has articulated and that he/she is working towards, a certain level of hope and excitement is evident in most members in the unit (team).	The desired future end-state that he/she has articulated and that he/she is working towards is highly aspirational, excites the majority of members and fills them with hope of a better (work) life to come.	He/she develops, expresses and shares an ideal, valued and as of yet unfulfilled future, that almost all members and a number of external parties come to internalise because it fills them with an aspirational life purpose filled with hope and excitement.	<b>6</b>
<b>C7</b>	<b>Attractive end-result</b>	The end-result associated with the vision that he/she has imagined and work towards appears to be disconnected to the way the world is moving and unattractive to unit (team) members and outsiders alike.	While not an entirely unattractive/unrealistic option to the status quo altogether, the end-results of the vision he/she has articulated and strive towards are relatively bland and non-inspirational.	In the vision that he/she has articulated and work towards, I believe that he/she has managed to capture some of the main attractive possibilities, benefits and/or end-results that are important to all members in the unit (team).	I believe that he/she has managed to capture 'universal needs' that are in touch with our industry, the way the world is moving, and that are important to all unit (team) members when articulating the end-results, opportunities or benefits that they can expect when working together to realise his/her vision.	He/she creates tangible meaning and purpose for people by gazing across the horizon of time and articulating the attractive opportunities that are store for when the unit (team) arrives at a distant destination.	<b>6</b>
<b>C8</b>	<b>Higher life purpose</b>	The message behind the desired future end-state that he/she has articulated and work towards does not persuade members of the unit (team) to challenge/subvert their own personal motives and concerns in favour of it, even for a short while.	The message behind his/her vision does slant towards a purpose higher than unit (team) member personal concerns, motives and needs but is not powerful enough to bind them into a collective force around this.	In general, I can see that the desired future end-state that he/she has articulated and work towards does, to a certain extent, bind unit (team) members together around a purpose higher than themselves.	The desired future end-state that he/she has articulated and that he/she is working towards is successful in persuading most unit (team) members to subvert their personal motives, needs and concerns and accept/internalise the message behind this vision's higher calling instead.	He/she appeals to (aspiring) followers' inherent human nature that strives for identification with a morally superior, higher life meaning/purpose, and leverages this appealing proposition to win people (unit members and outsiders) over to his/her cause.	<b>6</b>
<b>C9</b>	<b>Commitment</b>	The power of the message behind the vision that he/she has articulated and that he/she is working towards is not likely to result in any unit (team) members committing to this cause for any significant amount of time.	The power of the message behind the vision he/she has communicated and that he/she is working towards could conceivably tempt some individual team unit (team) members to commit themselves to this cause for the long-run.	The power of the message behind the vision he/she has communicated and that he/she is working towards is strong enough for a significant proportion of unit (team) members to commit to this purpose over the long-term.	The message behind the vision he/she has communicated and that he/she is working towards is powerful, and persuades most members to commit to working towards this better future.	He/she articulates the unit (team) members' inherent human need to be part of something bigger, stronger and better than themselves as part of his/her vision for the unit (team) in motivating almost all of them to commit to working towards a better future.	<b>6</b>
<b>C10</b>	<b>Self-efficacy beliefs</b>	He/she fails to convince members that they have the knowledge, skills and abilities to make his/her vision a reality.	The vision he/she has articulated and that he/she is working towards fails to adequately connect with unit (team) members in terms of their beliefs that they have the knowledge, skills and abilities that are required to make this vision a reality.	As part of the articulation of his/her vision, he/she has managed to convey the general message that unit (team) members have the knowledge, skills and abilities necessary to bring the vision to fruition.	He/she has consistently communicated and grown the belief in unit (team) members that they have the knowledge, skills and abilities to attain his/her vision of a more desirable future end-state.	He/she utilises expressions of a highly desirable future to create optimism in almost all unit (team) members and fuel their beliefs that they have the knowledge, skills and abilities necessary to bring his/her vision to fruition.	<b>6</b>



D	<b>ENTRENCHES A HIGH-PERFORMANCE CULTURE IN THE UNIT: Consistently behaves and makes decisions in a manner that serves the human condition by eliciting positively valenced psychological functioning in followers.</b>						
	<b>Denotations</b>	<b>Significant development area</b>	<b>Development area</b>	<b>On par/satisfactory</b>	<b>Strength</b>	<b>Well-developed strength</b>	<b>Cannot rate</b>
		<b>1</b>	<b>2</b>	<b>3</b>	<b>4</b>	<b>5</b>	<b>6</b>
<b>D1</b>	<b>Human engagement</b>	He/she treats other members in the unit (team) as <i>performance machines</i> .	His/her actions, decisions and the ways in which he/she engages with unit (team) members are professional, yet somewhat clinical and indifferent.	He/she treats everyone as professionals, fairly and with the necessary amount of respect as per their station in the unit (team).	He/she goes out of his/her way to make everyone feel like they are respected human beings and valued members of the unit (team).	The decisions he/she makes and the way he/she engages unit (team) members reflects his/her respect for all unit members irrespective of rank or position and resonate with them as human beings that aspire to a better way of life.	<b>6</b>
<b>D2</b>	<b>Energising others</b>	His/her actions and behaviours towards others drain the energy of them at work.	His/her actions and behaviours towards others somewhat stifle their natural energy at work.	His/her actions and behaviours towards others in general succeeds in energising the most important members in the unit (team).	As a rule, his/her everyday conduct elicits positive energies from the other members in the unit (team).	His/her actions and behaviours consistently energise all unit (team) members towards improved performances at work.	<b>6</b>
<b>D3</b>	<b>Performance role-model</b>	The type of behaviours he/she models at work do not inspire performance (or product/service) improvement in others at all.	Despite sometimes trying, his/her behaviours do not seem to inspire others to any significant performance (or product/service) improvements at work.	He/she succeeds in role modelling the required performance (or product/service) standards at work and this appears to cascade down to some members in the unit (team).	He/she succeeds in role modelling more than the required performance (or product/service) standards at work and this appears to cascade down to the majority of members in the unit (team).	Through the consistent role modelling of outstanding performance over time, he/she has contributed to a special "personality"/high performance culture in my team (unit) that inspire members to higher performances (better product/service offerings) at work.	<b>6</b>
<b>D4</b>	<b>Servitude</b>	He/she takes what he/she can from others to improve his/her own situation and actively enforces policies and rules in order to protect his/her position in the unit (team).	He/she tries to keep others from cutting corners and protects him/herself from reprimands by actively enforcing company rules/policies and other bureaucratic procedures.	Whenever, he/she can and within reason, he/she tries to be there for others in the unit (team) and removes overly bureaucratic obstacles out of their way.	He/she repositions him/herself as an empathetic 'helper' in the unit (team) and fulfils this role by assisting others in making their daily work easier and more enjoyable.	He/she acts in complete servitude of others and does everything in his/her power to make the work environment in the unit (team) more employee-centric/friendly for them and removes (bureaucratic) obstacles out of their way.	<b>6</b>
<b>D5</b>	<b>Psychological climate</b>	Others from the outside seem to avoid (joining) our unit (team) because of the forbidding and unhealthy climate that he/she creates or contributes to in the unit (team).	He/she has a bit of a reputation for being part of the cause for an amount of dissatisfaction with the negative and tense psychological climate that prevails in the unit (team).	In general, the psychological climate he creates/contributes to in the unit (team) is positive and appealing to others.	The psychological climate he/she creates/contributes to is upbeat, healthy and motivates most members in the unit (team) to express extra effort in their work.	Others from outside often want to join our unit (team) and contribute because they value the way he/she protects/stands up for and emphasises with others when necessary and (contributes to) nurtures a psychologically positive and performance stimulating climate in the unit (team).	<b>6</b>

<b>D6</b>	<b>Psychological safety I</b>	Fellow unit (team) members seem to creep back into their shells because of the critical, impersonal, and inconsistent manner in which he/she engages with others.	His/her inconsistent and unfair conduct sometimes 'scares' other people in the unit (team) to hide their 'full' selves at work from him/her and from others in the unit (team).	Generally speaking, his/her decisions, actions and behaviours are fair and consistent and make unit (team) members feel psychologically safe to express and be themselves at work.	Through consistently fair and up-building actions and behaviour he/she demonstrates to others that he/she welcomes the authentic expression of everyone at work.	He/she inspires members in the unit (team) to apply themselves authentically to their work because his/her behaviour is fair and consistent and greatly contribute to the environment and conditions in which they feel psychologically safe and motivated to do so.	<b>6</b>
<b>D7</b>	<b>Psychological safety II</b>	His/her behaviours, decisions and actions demonstrate allegiance to his/her position and not to those around him/her.	He/she demonstrates allegiance to some of the colleagues close to him/her in the unit (team) but generally, his/her decisions and actions are governed by what serves his/her position in the unit (team) and what the position requires from him/her and not the welfare of others.	He/she prioritises allegiance equally between others around him/her and the responsibilities of his/her position.	In general, his/her behaviours and decisions are aimed at protecting and nurturing those around him/her in addition to doing his/her job.	His/her behaviours, decisions and actions demonstrate total allegiance to and care for the people around him/her in addition to what is required of him/her in his/her position.	<b>6</b>
<b>D8</b>	<b>Improvement motivation</b>	His/her actions and behaviours at work do not seem to motivate others in the unit (team) to become better in their jobs and in life in general at all.	He/she struggles to get others to buy into the idea that they can be better employees and people through his/her conduct at work.	His/her conduct at work succeeds in getting some of the others to follow his/her lead in being better employees and human beings.	His/her conduct at work succeeds in getting the majority of the unit's (team) members to strive towards being better employees and human beings.	His/her actions and behaviours motivate almost all unit (team) members to be better employees and human beings.	<b>6</b>
<b>D9</b>	<b>Morality</b>	He does not demonstrate what his/her moral beliefs are in the manner in which he/she conducts him/herself at work: rather what he/she does at work and the way he/she conducts him/herself is governed by popular opinion and what he/she needs to do in order to keep his/her job/position in the unit (team).	He/she demonstrates moral beliefs/principles at work but adapts his/her actual behaviour/decisions sometimes to what is required in order to remain popular in the unit (team) and protect his/her career.	He/she has a strong set of moral beliefs that generally serves as his/her compass when making decisions that have the potential to negatively affect his/her popularity and career in the unit (team).	He/she makes decisions and behaves according to a set of strong moral beliefs and it is these principles that govern his/her behaviours, actions and decisions and not the need to be popular or to preserve his/her own career in the unit (team).	His/her actions and behaviours at work demonstrate that he/she fights for what is right and that he/she never sacrifices his/her moral beliefs and principles in order to be popular and advance/preserve his/her career in the unit (team).	
<b>D10</b>	<b>Responsibility/blame</b>	He/she is quick to pick up whose fault it was that the unit (team) did not perform and to put all the blame for non-performance on these individuals.	He/she tends to blame others when the performance of the unit (team) is not up to standard.	He/she takes (his/her share of the) responsibility for the overall performance of the unit (team) but sometimes when things go wrong badly, he/she cannot help but to single out certain individuals who played the biggest part in the collective's failure.	Generally, he/she takes (his/her share of the) responsibility for the overall performance of the unit (team) even when it is clear who was at fault for the failure of the collective.	He/she takes total responsibility for the performance outcomes of the unit (team) and never blames/crucifies individuals when things go wrong.	<b>6</b>

<b>E DEVELOPS UNIT COMPETITIVENESS: Develops and secures resources for exploiting viable, eco-friendly and sustainable opportunities necessary for the occupation of a morally superior, winning market position for the unit.</b>							
	<b>Denotations</b>	<b>Significant development area</b>	<b>Development area</b>	<b>On par/satisfactory</b>	<b>Strength</b>	<b>Well-developed strength</b>	<b>Cannot rate</b>
		<b>1</b>	<b>2</b>	<b>3</b>	<b>4</b>	<b>5</b>	<b>6</b>
<b>E1</b>	<b>Green performance</b>	He/she does not manage to align the unit's (team's) performance strategy with environmentally-friendly practices/considerations at all.	Despite some degree of effort on his/her side, the unit's (team's) performance strategy is not really aligned with universally accepted eco-friendly practices/considerations that are incorporated by other organisations.	He/she has managed to shape the unit's (team's) performance strategy so as to incorporate most of the mainstream eco-friendly practices/considerations that most other companies ascribe to.	His/her actions have led to our unit's (team's) performance strategy being aligned to and on par with some of the leading eco-friendly companies around.	Due to his/her efforts, ground-breaking, market-leading eco-friendly practices form the base framework around which the unit's (team's) performance strategy is designed.	<b>6</b>
<b>E2</b>	<b>Resource security</b>	He/she struggles to put structures, deals and arrangements in place to secure any sort of high-priority resources for the unit (team) that are necessary for our operational efficiency.	He/she has managed to secure some high-priority resources for the unit (team) that would have been lost to us if he/she had not stepped in. In other cases, however, he/she struggles to secure the resources necessary for our operational efficiency.	He/she consistently manages to secure most of the important resources the unit (team) needs to stay operationally competitive.	He/she consistently manages to secure enough resources for the unit (team) so as to allow us scope for increasing our performance/competiveness through the availability of surplus materials, staff and finances.	Due to his/her actions and efforts, the unit (team) has unfettered and timeous access to almost all resources (human, material, financial) that our operations depend on.	<b>6</b>
<b>E3</b>	<b>Market niche</b>	He/she has not managed to add anything new and innovative to the unit's (team's) performance strategy at all.	He/she has managed to identify some new business streams and ideas for consideration in our unit's (team's) performance strategy but nothing that has really paid off substantially.	He/she has been known to capitalise on new business ventures/streams and ideas to improve the unit's (team's) performance strategy and product/service offering.	He/she regularly capitalises on new business ventures/streams and ideas to improve the unit's (team's) performance strategy.	His/her consistent contribution to the performance strategy of the unit (team) is so clever and innovative that due to it, the team (unit) will continue to be relevant and successful in the market for a long time.	<b>6</b>
<b>E4</b>	<b>Buy-in</b>	He/she has not managed to shape the unit's (team's) performance strategy towards the needs/concerns of any other constituencies of the greater society in which we operate.	He/she manages to shape the unit's (team's) performance strategy towards compliance with governmental regulations/rules but not the concerns of any of the other relevant constituencies in the society in which we operate.	He/she has shaped the unit's (team's) performance strategy in such a way so as to address most of the concerns of the constituencies of the society in which we operate (i.e. government, customers, lobby groups, etc.).	He/she has shaped the unit's (team's) performance strategy in such a way that most constituencies of the society in which we operate will not be able to substantially criticise it on any legitimate grounds.	His/her contribution to the performance strategy of the unit (team) led to the widespread acceptance thereof because the concerns of all of the relevant constituencies have been properly consulted due to the manner in which he/she advocated the importance of such buy-in.	<b>6</b>
<b>E5</b>	<b>Overall impact</b>	His/her contributions to the performance strategy of the unit (team) does not affect its chances of long-term success at all.	His/her contributions to the performance strategy of the (team) marginally increases its chances of long-term success.	His/her contributions to the performance strategy of the unit (team) does have some positive impact on the chances of our long-term success.	In general, his/her contributions to the performance strategy of the unit (team) positively affects our chances of being successful in the long run.	The contribution that he/she has made to the performance strategy of the unit (team) greatly increases the chances of the unit (team) being successful in the long-run.	<b>6</b>

<b>E6</b>	<b>Market standing</b>	He/she is one of those that consistently fails in trying to position the unit (team) as one of the market leaders in the industry/field in which we operate.	Despite some degree of effort, he/she cannot manage to influence our unit's (team's) performance strategy to the extent that we can improve our market position so as to become part of the top half of the competitors in the industry/field in which we operate.	His/her contributions to the performance strategy of the unit (team) has directly led to us becoming part of the top 50-30% of companies in the field/industry in which we operate.	His/her contributions to the performance strategy of the unit (team) has directly led to us becoming part of the top 20% of companies in the field/industry in which we operate.	The fact that our unit (team) is positioned as one of the top work units (teams) of its kind in the field/industry is greatly due to his/her contributions to our performance strategy.	<b>6</b>
<b>E7</b>	<b>Process performance</b>	He/she fails to shape the unit's (team's) performance strategy towards a adopting a better/improved production process.	Due to his/her contributions to the unit's (team's) performance strategy, marginal improvements have been made to our value chain and internal processes.	He/she routinely impacts positively on the quality of our value chain and internal processes through his/her contributions to the unit's (team's) performance strategy.	In general, he/she shapes the unit's (team's) performance strategy so that we routinely improve and sometimes even revolutionise our value chain and internal processes.	The fact that our unit (team) operates on a world-class conversion process is greatly due to his/her efforts and input to our performance strategy.	<b>6</b>
<b>E8</b>	<b>Economic performance</b>	His/her input to our unit's (team's) performance strategy has not really led to any change in our profit margins and has not stimulated economic growth in our community.	His/her input to our unit's (team's) performance strategy has led to a marginal increase in our profit margins but not any significant economic growth in our community.	His/her input to our unit's (team's) performance plan has led to consistent increases in our profit margins and stimulated some economic growth in our community.	His/her input to our unit's (team's) performance plan has led to substantial increases in our profit margins and economic growth in the organisation and our community.	Due to his/her contributions, the performance strategy of our unit (team) is highly entrepreneurial and stimulates high levels of economic growth in the organisation and our community.	<b>6</b>
<b>E9</b>	<b>Product/Service output performance</b>	His/her input to our unit's (team's) performance strategy has not led to any improvements with regards to the quality of our products and service delivery.	His/her input to our unit's (team's) performance strategy has led to marginal improvements with regards to the quality of our products and service delivery.	His/her input to our unit's (team's) performance strategy has led to decent improvements in our product quality and service delivery.	His/her input to our unit's (team's) performance plan has led to great improvements in our product quality and service delivery.	The fact that our unit (team) can consistently deliver real value to internal and external customers efficiently, effectively and dependably is greatly due to his/her efforts.	<b>6</b>
<b>E10</b>	<b>Market benchmark</b>	He/she is one of those that fails in positioning our unit (team) as the benchmark of competitiveness/excellence in the market in which we operate.	Despite some improvements, he/she cannot manage to influence our unit's (team's) performance strategy to the extent that we can market ourselves as the benchmark for the competitors in the industry/field in which we operate quite yet.	His/her contributions to the unit's (team's) performance strategy have resulted in us being able to compete on even footing with some of the leaders in the industry/field in which we operate.	His/her contributions to the unit's (team's) performance strategy have resulted in us becoming one of the benchmarks of excellence/competitiveness in the market/industry in which we operate.	The fact that others in a similar industry or field regard our performance strategy as the ultimate benchmark of competitiveness/excellence in the market is greatly due to his/her efforts in developing the blueprint for it.	<b>6</b>

<b>F INVOLVES OTHERS AND ELICITS PARTICIPATION: Provides scope and opportunities for followers to spontaneously contribute their full talents/capabilities.</b>							
	<b>Definitions</b>	<b>Significant development area</b>	<b>Development area</b>	<b>On par/satisfactory</b>	<b>Strength</b>	<b>Well-developed strength</b>	<b>Cannot rate</b>
		<b>1</b>	<b>2</b>	<b>3</b>	<b>4</b>	<b>5</b>	
<b>F1</b>	<b>Managing the contributions of others</b>	He/she micro manages all his/her projects and the other unit (team) members that are involved in them by forcing his/her idea of what needs to be done and how this should be done onto others.	When working with other unit (team) members on a project, he/she often tells others what they must do and how they must do it.	When working with other unit (team) members on a project, he/she tries to incorporate each members' unique talents, input and contributions for the betterment of the project.	When working with other unit (team) members on a project, he/she actively encourages them to improvise on the current status quo/performance process.	When he/she is dependent on other unit (team) members for the success of a project, he/she gives them total freedom and discretion to run their tasks/assignments the way they see fit in order to improve on the current status quo/performance process.	<b>6</b>
<b>F2</b>	<b>Locus of decision-making responsibility</b>	He/she ascribes to the notion that managers should make all decisions about the performance of the unit (team) and lives by this rule.	Sometimes he/she pushes for shared decision-making in the unit (team) but at other times, he/she lets management step in to call the shots.	In his/her work life, he/she favours the notion that everyone should be part of the decision-making process about the performance of the unit (team) but he/she can be more proactive in ensuring that this actually consistently happens.	He/she actively champions the notion that the responsibility for decision-making and performance should be shared equally between managers and staff in the unit (team).	As a result of his/her actions, shared responsibility (between managers and staff) for decision-making in the unit (team) has become a daily reality for us.	<b>6</b>
<b>F3</b>	<b>Delegation of decision-making authority</b>	He/she discourages the practice where management delegates decision-making authority to members that may affect the entire unit's (team's) performance.	As a rule, he/she discourages the practice where management delegates decision-making authority to unit (team) members but under extraordinary circumstances, he/she would not counter this where it is done.	In general he/she encourages the practice where management delegates decision-making authority to team members, but mostly only to those members he/she feels can handle the additional responsibility to do so.	He/she fights for and welcomes the practice where management delegates decision-making authority to all team (unit) members so that they have more freedom to make decisions that affect our jobs and performance at work.	Because of his/her actions, the extensive delegation of decision-making authority to all team (unit) members has become a daily reality for us in the unit (team).	<b>6</b>
<b>F4</b>	<b>Locus of change authority</b>	He/she discourages unit (team) members to change a standard work approach, process or strategy and feels uncomfortable when someone actually tries to do so.	As a rule, he/she discourages others from changing a standard work approach, process or strategy but sometimes under extraordinary circumstances, he/she would buy in to the need to do so.	He/she works on the basis that he/she wants everyone to be free to make minor changes to a standard work approach, process or strategy to improve our collective performance but in extreme cases, he/she still wants people to run this by management first.	He/she works on the basis that senior individuals in the unit (team) should have the authority to change a standard work approach, process or strategy to improve the performance of the collective but that more junior (or new) members should check with management before they do so first.	He/she always encourages and welcomes it when any unit (team) member spontaneously changes/modifies a work approach, process or strategy in order to improve the performance of the unit (team) and accepts responsibility for it.	<b>6</b>
<b>F5</b>	<b>Authentic expression</b>	His/her decisions, actions and behaviours stifle the spontaneity of fellow unit (team) members in contributing their natural talents to the performance process.	Despite good intentions, his/her conduct sometimes causes some of the weaker members to withdraw themselves from the unit's (team's) performance process.	The way that he/she engages with members in the unit (team) is generally conducive to them spontaneously applying their natural talents to the performance process.	His/her daily interactions and engagements with members in the unit (team) stimulates their need to apply their natural talents to the performance process.	His/her actions and behaviours at work brings the 'authentic' best out of the people in the unit (team).	<b>6</b>

<b>F6</b>	<b>Work scope</b>	He/she believes that everyone in the unit (team) should follow their job descriptions pedantically and he/she implements this credence religiously as part of his/her every day work life.	He/she lives by the rule that job descriptions should be followed to the letter but will not try to counter/discourage it when a unit (team) member gets involved in projects beyond their assigned duties occasionally.	He/she actively encourages unit (team) members to get involved in projects/assignments/tasks that are not directly related to their normal daily duties and tries to make it easier for them to do so.	Because of his/her efforts, he/she gets most people in the unit (team) a little bit more involved in projects/tasks/assignments that are not directly related to their normal duties at work.	He/she shapes the work environment so as to give all members the freedom to decide how and when to expand their own work roles and become more involved in projects/tasks/assignments that are not directly related to their normal, daily duties.	<b>6</b>
<b>F7</b>	<b>Eliciting input</b>	He/she does not think that employees should be given the opportunity via meetings to provide their input to decisions that are made about our collective performance and behaves accordingly at work.	He/she does not ascribe to regular meetings where unit (team) members have the opportunity to provide their opinions on decisions that are made about our collective performance and behaves accordingly at work.	He/she believes there are benefits in having meetings with the purpose of giving unit (team) members the opportunity to provide their input to decisions that are made about our collective performance and behaves accordingly at work.	He/she believes that there are benefits in actively eliciting the input of employees during meetings concerning decisions about our collective performance and behaves accordingly at work.	He/she shapes the work environment so as to conduct frequent meetings during which the opinions of unit (team) members are heard and incorporated into our unit (team) performance on a daily basis.	<b>6</b>
<b>F8</b>	<b>Planning responsibility</b>	He/she ascribes to the notion that managers are there to completely plan and organise employee projects/tasks on behalf of them and he/she behaves accordingly at work.	He/she believes that managers should spend a lot of time to assist employees to plan and organise their projects/tasks for them and he/she behaves accordingly at work.	He/she believes that there should be a 50-50 responsibility between management and employees in terms of who plans and organises the work for employees and he/she behaves accordingly at work.	He/she believes that managers should at least check that employees have planned and organised their projects/tasks correctly and he/she behaves accordingly at work.	He/she shapes the work environment so that unit (team) members have complete authority to make decisions about how to organise, manage and take accountability of their own projects.	<b>6</b>
<b>F9</b>	<b>Spontaneity of contributions</b>	He/she believes that it is not the place of unit (team) members to provide input to unit (team)-decision making and performance when their opinion is not consulted and he/she behaves accordingly at work.	He/she believes that unit (team) members should try to refrain from providing their input to team decision-making and performance when not asked for their opinion and he/she behaves accordingly at work.	He/she believes that unit (team) members should sometimes be allowed to provide their input to team decision-making and performance without being asked for their opinion and he/she behaves accordingly at work.	In general, he/she believes that unit (team) members should be allowed to provide their input to team decision-making and performance whenever they feel like contributing and he/she behaves accordingly at work.	He/she shapes and contributes to a work environment where unit (team) members spontaneously provide input to team decision-making and performance whenever they feel the need to do so.	<b>6</b>
<b>F10</b>	<b>Cascading of responsibility</b>	He/she believes that managers should have complete power over the direction and performance of the collective and behaves accordingly at work.	He/she believes that managers should only involve unit (team) members with matters concerning the direction and performance of the collective under special circumstances and he/she behaves accordingly at work.	He/she believes that unit (team) members should be aware of and be able to question the direction and performance strategy of the collective and behaves accordingly at work.	He/she ascribes to the notion that management should trust their followers' capabilities and natural talents and make them more accountable for the performance of the collective and he/she behaves accordingly at work.	He/she shapes the work environment so as to ensure that management relinquishes power and grooms others to take accountability for the performance of the collective.	<b>6</b>

<b>G UNITES AND CONNECTS FOLLOWERS: Brings followers together and unites them in fortified, mutually supportive relationships.</b>							
	<b>Definitions</b>	<b>Significant development area</b>	<b>Development area</b>	<b>On par/satisfactory</b>	<b>Strength</b>	<b>Well-developed strength</b>	<b>Cannot rate</b>
		<b>1</b>	<b>2</b>	<b>3</b>	<b>4</b>	<b>5</b>	
<b>G1</b>	<b>Resolving differences</b>	He/she does not take notice of the dynamics of socio-emotional processes and interactions that take place in the unit (team) at all and lets members take care of any personal feuds/ differences that may arise between them themselves.	He/she is vaguely aware of the changing socio-emotional dynamics in the unit (team) but loathe (or are unable) to step in and assist members to resolve personal differences that may negatively influence team dynamics and performance.	He/she is aware of the more prominent socio-emotional processes and interactions that occur in the unit (team) and has been known to step in on occasion to avoid that personal differences between members negatively influence unit (team) dynamics and performance.	He/she is on top of the socio-emotional processes and interactions that exist and occur in the unit (team) and manages to properly resolve most personal differences between members through (informal) mediation and conciliation before they can negatively influence unit (team) dynamics and performance.	He/she pays close attention to socio-emotional processes and interactions in the unit (team) and openly and promptly resolves personal differences between members fairly and effectively through the appropriate intervention before they can negatively influence team dynamics and performance.	<b>6</b>
<b>G2</b>	<b>Facilitating personal information sharing</b>	He/she prefers it if unit (team) members do not communicate with each other about their personal lives at all and discourages the sharing of personal information at work.	He/she leaves others to decide for themselves how much of their selves and personal lives they want to share with other members in the unit (team), but he/she shares as little as possible.	He/she actively tries to connect some like-minded, similar people in our unit (team) with each other and him/herself so that we can provide each other with bits of personal information about ourselves for future support and rapport.	He/she encourages even diverse unit (team) members to share personal information with each other and him/herself so that we can give and receive support from each other and build a basis for understanding and mutual support.	He/she encourages and creates many informal opportunities for all unit (team) members at work to give and receive support, get glimpses of each other's' lives and share personal information with each other to build understanding rapport.	<b>6</b>
<b>G3</b>	<b>Facilitating work life sharing</b>	He/she prefers it if unit (team) members stick to their own work and do not know too much about the work life (i.e. challenges, tasks, deadlines, needs, etc.) of others and he/she behaves according to this rule at work.	He/she rarely takes the time to inform people about the work life details (i.e. challenges, tasks, deadlines, needs, etc.) of others in the unit (team) and rather keeps this type of information private.	He/she actively makes members aware of the details of the work life (i.e. challenges, tasks, deadlines, needs, etc.) of others in the unit (team) in order to facilitate better intra-group understanding and cooperation.	He/she tries to see where there are opportunities at work to assist unit (team) members to get to know and understand each other's work life (i.e. challenges, tasks, deadlines, needs, etc.) better and use these to improve intra-group understanding.	He/she capitalises on all opportunities at work to assist unit (team) members to get to know and understand each other's' work life (i.e. challenges, tasks, deadlines, needs, etc.) on a very deep level.	<b>6</b>
<b>G4</b>	<b>Facilitating open debates</b>	He/she tries to censor and actively discourages open debates in the unit (team).	He/she tries to steer (new) debates in the unit (team) away from sensitive/controversial subjects and topics.	He/she sometimes stirs debate in the unit (team) on a number of new interesting and relevant topics, even though these might be slightly sensitive or controversial at times.	He/she actively encourages everyone in the unit (team) to open up debate on various new important topics that are sometimes sensitive/controversial, but especially those that are constructive and in support of our unit's (team's) objectives and performance.	He/she actively encourages everyone in our unit (team) to talk about anything and everything with each other that are of relevance to us, and even invites healthy debate on controversial or taboo topics that have been never openly discussed before.	<b>6</b>

<b>G5</b>	<b>Work structuring</b>	He/she prefers to have individuals assigned to different, separate tasks that require little collaboration/ communication with others and try to structure his/her projects/assignments accordingly.	Sometimes he/she structures his/her projects around getting the contributions simply of individual role-players in isolation from others while at other times; he/she structures projects so as to facilitate a little collaboration between members in the unit (team).	He/she structures most of the projects he/she manages so that at least some form of communication and collaboration is required between project participants.	He/she actively tries to structure and organise work/tasks in his/her projects so that unit (team) members need to collaborate and communicate with each other to some extent.	He/she actively tries to structure and organise work/tasks in his/her projects so that unit (team) members need to frequently collaborate and communicate with each other over extended periods of time.	<b>6</b>
<b>G6</b>	<b>Relationship building</b>	He/she is not able to build relationships between people in the unit (team) at all.	He/she struggles to get others to get to know each other and to get along with each other in the unit (team).	He/she connects people with similar backgrounds and interests to each other via mutual areas of concern and manages to build relationships in the unit (team) in this way.	He/she connects diverse people through events and by purposefully getting specific individuals assigned to projects, tasks, committees or workgroups and manages to build strong relationships in the unit (team) in this way.	He/she actively builds bridges and forges strong relationships all over the unit (team) and between highly diverse people in my unit (team).	<b>6</b>
<b>G7</b>	<b>Leveraging diversity</b>	Despite some effort from his/her side, generational and cultural differences and stereotypes between members continue to prevail and breed conflict in the unit (team).	He/she is one of those that find it difficult to get people with generational and cultural differences to put these aside and bond together properly with others in the unit (team).	He/she has managed (or have contributed) to smooth out some of the main generational and cultural differences between members in the unit (team) leading to some people bonding with each other and him/her to a certain extent.	Due to his/her efforts, people from different backgrounds and generations understand each other better to such an extent that general/cultural value differences do not normally hamper the operational efficiency of the unit (team).	Because of his/her efforts, members from different generations and cultures have formed a special and unified bond in the unit (team) characterised by learning, cross-pollination, sharing and understanding.	<b>6</b>
<b>G8</b>	<b>Sense of belonging</b>	He/she has failed to create any sense of belonging for any of the diverse members in the unit (team).	He/she is one of those that fail to create a strong sense of belonging for any of the diverse members of our unit (team).	He/she has managed (or contributed) to create a sort of an in-group out of a diverse member population that satisfies peoples' need to belong to something bigger than themselves.	Greatly due to his/her efforts, members have not only become very attracted to our unit (team) as an entity itself but to most (if not all) of its members as well.	Through his/her actions and influence in standing up for others around him/her, he/she has managed to instil a strong sense of belonging for all members in the unit (team).	<b>6</b>
<b>G9</b>	<b>Cooperation and trust</b>	He/she is one of those that fail to get members to trust each other and to cooperate with each other fully in the unit (team).	He/she is one of those that struggle to get other members in the unit (team) to trust each other and to truly cooperate with each other.	He/she has managed to get (or contributed to) some of the more important members in our unit (team) to trust each other and to cooperate with each other at high levels of reciprocity.	He/she has managed to get (or greatly contributed to) most of the members in our unit (team) to trust each other and to generally work on a highly cooperative basis with each other.	Due to his/her efforts, purposeful relationships between diverse members have formed all across the unit (team) that are characterised by deep trust and strong cooperation.	<b>6</b>
<b>G10</b>	<b>Synergy</b>	He/she fails to get any synergistic interactions going between members in the unit (team).	He/she struggles to get synergistic interactions going between diverse members in the unit (team).	He/she has managed to get (or his/her efforts have contributed to) some of the more important members in the unit (team) to function synergistically as a collective.	He/she has managed to get (or his/her efforts have contributed to) most of the members in the unit (team) to function synergistically as a collective.	Due to his/her efforts, there exist great synergies between diverse members that affect significant process gains in the unit (team).	<b>6</b>



<b>H STRENGTHENS AND ENABLES FOLLOWERS: Raises the confidence and performance capabilities of followers towards success and high levels of achievement.</b>							
	<b>Definitions</b>	<b>Significant development area</b>	<b>Development area</b>	<b>On par/satisfactory</b>	<b>Strength</b>	<b>Well-developed strength</b>	<b>Cannot rate</b>
		<b>1</b>	<b>2</b>	<b>3</b>	<b>4</b>	<b>5</b>	
<b>H1</b>	<b>Problem-solving fundamentals</b>	He/she seldom if ever trains the unit (team) to become better at problem solving at a collective level of competence.	At best, he/she only provides some tidbits of advice as to how the unit (team) can become better at solving problems at a collective level of competence.	He/she has had some good attempts at teaching the unit (team) to be more successful at problem solving at a collective level of competence but probably need some (more) practical experience in order to be able to do this effectively.	At times, he/she is successful at training the unit (team) to become better at problem-solving, fact-finding and solution generation.	He/she often and successfully trains the unit (team) to become better at problem-identification, fact-finding and solution generation.	<b>6</b>
<b>H2</b>	<b>Coaching</b>	He/she leaves others to sort out their personal performance problems by themselves.	He/she will only become involved in assisting others with their performance problems when they request assistance explicitly and even then, struggles to come up with practical solutions/strategies that work for them.	He/she sometimes provides others with some good advice and practical instruction as to how they could overcome current and future performance problems.	He/she often provides others with some practical advice and instruction as to how they could overcome current and future performance problems.	He/she is highly successful at teaching quite a number of individual unit (team) members to overcome any performance problems that they might have or that they might develop over the course of time.	<b>6</b>
<b>H3</b>	<b>Hope and optimism</b>	He/she does not manage to inspire hope and optimism about the future success of the unit (team) in others around him/her at all.	He/she struggles to inspire confidence and assurance about the future success of the unit (team) in others around him/her.	He/she generally has a positive outlook about the future success of the unit (team) that spills over to some of the colleagues around him/her.	He/she has an exceedingly optimistic outlook about the future success of the unit (team) and this belief rubs off on many of his/her colleagues at work.	He/she demonstrates unwavering hope and optimism about the future success of the unit (team) and his/her resilience in this regard rubs off on all of the members in the unit (team) around him/her.	<b>6</b>
<b>H4</b>	<b>Collective meta-cognition</b>	He/she seldom if ever teaches the unit (team) how to self-reflect and <i>learn how to learn</i> at a collective level of competence.	At best, he/she only provide some tidbits of advice as to how the unit (team) can become better <i>at learning how to learn</i> at a collective level of competence.	He/she has had some good attempts at teaching the unit (team) how to become better <i>at learning how to learn</i> at a collective level of competence but probably need some (more) practical experience in order to be able to do this effectively.	At times, he/she is successful at training the unit (team) to self-reflect on their performance and <i>learn how to learn</i> at a collective level of competence.	He/she often and successfully teaches the unit (team) to learn by themselves - i.e. to self-reflect and learn from procedures, tactics and operational choices by which they pursue objectives and challenging assignments.	<b>6</b>
<b>H5</b>	<b>Development</b>	He/she fails to provide any significant developmental assistance and advice to	He/she struggles to provide any colleagues at work with developmental assistance and advice of any real value.	He/she manages (or contributes) to grow the skills and experience base of certain individuals that he/she is	He/she manages (or contributes) to grow the skills and experience base of even key individuals in the unit (team) as is	He/she successfully develops the bandwidth (i.e. portfolio of knowledge, experience and skills) of all of the	<b>6</b>

		any of his/her colleagues at work at all.		close to in the unit (team) as is necessary for the (current and future) performance requirements of the unit (team).	necessary for the (current and future) performance requirements of the unit (team).	individuals around him/her in line with the growth and future performance requirements of the unit (team).	
<b>H6</b>	<b>Mentoring</b>	He/she really has not even managed to start to assist others around him/her in improving their personal and/or work life.	He/she has come up with some ideas for others around him/her on some constructive ways in which they can improve themselves (personally and at work), yet do not motivate or gain commitment from them to do so.	He/she has some good ideas in terms of what the areas are that certain colleagues could improve in (personally and at work) and utilises these to motivate some to set off on constructive journeys for such self-development to occur.	He/she provides some close colleagues in the unit (team) with sound career development objectives, models/suggests the appropriate developmental strategies to achieve these, and observes, motivates and records their progress towards these.	He/she provides the majority of members in the unit (team) with sound career development objectives, models/suggests the appropriate developmental strategies to achieve these, and observes, motivates and records colleagues' progress towards these.	<b>6</b>
<b>H7</b>	<b>Freethinking</b>	He/she cannot persuade nor inspire others around him/her to adopt a more freethinking, uninhibited approach when planning new assignments/projects at all.	He/she struggles to get others around him/her to adopt a more freethinking, uninhibited approach when planning new assignments/projects.	On occasion, he/she pushes colleagues to come up with new, fresh ways of thinking about new projects and assignments but in general, we usually fall back on our proven, traditional ways of thinking.	More often than not, he/she gets the unit (team) to move away from our traditional way of thinking when planning for the completion of new assignments/project.	He/she successfully encourages the unit (team) to routinely and uninhibitedly experiment with different perspectives, non-traditional thinking and different strategies to complete new assignments/projects.	<b>6</b>
<b>H8</b>	<b>Training</b>	He/she does not have the motivation nor the capacity to spare to physically train others how to improve their performance at work.	On occasion, he/she has talked some colleagues through ways of improving their performance at work but he/she does not follow through to ensure that they properly incorporate this advice at work.	He/she sometimes provide others around him/her with structured training and follow-ups on how they could overcome current and future performance problems and become more effective in their jobs.	He/she often provides others around him/her with structured training and follow-ups on how they could overcome current and future performance problems and become more effective in their jobs.	He/she capitalises on all possible opportunities to conduct in the on-the-job training of individuals around him/her by showing them what to do and giving them the opportunity to show that they can truly implement what he/she has taught them.	<b>6</b>
<b>H9</b>	<b>Succession</b>	He/she does not contribute to the development and preparation of the next generation of leaders, managers or supervisors in the unit (team) at all.	He/she sometimes plays a small part in preparing and developing certain individuals for key roles that they have been earmarked for in the future.	He/she contributes as much to the preparation and development of individuals that are earmarked for more senior/critical roles in the future as the average member in the unit (team).	Due to his/her efforts, planning and hard work, the unit (team) has competent successors available for some of the more critical positions that differentiate our unit (team) as a top service/product provider from our competitors.	Due to his/her efforts, planning and hard work, we have competent successors available for all of the critical positions that differentiate our unit (team) as a top service/product provider from our competitors.	<b>6</b>
<b>H10</b>	<b>Collective self-efficacy</b>	He/she cannot seem to get others around him/her to believe that our unit (team) as a collective is capable of achieving extraordinary performance results and objectives at all.	He/she struggles to get others around him/her to believe that our unit (team) as a collective is capable of achieving extraordinary performance results and objectives.	He/she manages to get some of the more important role-players to buy-into the idea that our unit (team) as a collective is capable of achieving extraordinary performance results and objectives.	He/she manages to get the majority of our people to buy-into the idea that our unit (team) as a collective is capable of achieving extraordinary performance results and objectives.	He/she grows and fortifies everyone's beliefs in our unit (team) that we are capable of extraordinary heights and levels of performance.	<b>6</b>

<b>I MANAGES THE INTERNAL WORK UNIT ENVIRONMENT: Maintains a hands-off procedural view and executes in-process corrections as and when required to ensure that different components of the conversion process keep pulling in the same direction.</b>							
	<b>Definitions</b>	<b>Significant development area</b>	<b>Development area</b>	<b>On par/satisfactory</b>	<b>Strength</b>	<b>Well-developed strength</b>	<b>Cannot rate</b>
		<b>1</b>	<b>2</b>	<b>3</b>	<b>4</b>	<b>5</b>	
<b>I1</b>	<b>Work speed regulation</b>	He/she does not even know where to start if asked to regulate the work speed of different individuals/teams in order to ensure on-time product/service delivery in our unit (team).	He/she is not (yet) competent at regulating the work speed of different individuals/teams in order to ensure on-time product/service delivery in our unit (team).	He/she is able to regulate the work speed of different individuals/teams that are part of the different components of our unit's (team's) conversion process so as to ensure on-time product/service delivery.	He/she is quite astute at regulating the work speed of different individuals/teams that are part of the different components of our unit's (team's) conversion process so as to ensure on-time product/service delivery.	He/she is an expert at regulating the work speed of different individuals/teams that are part of the different components of our unit's (team's) conversion process so as to ensure on-time product/service delivery.	<b>6</b>
<b>I2</b>	<b>Balancing material resources</b>	He/she does not even know where to start if asked to shift critical material resources between different components of our unit's (team's) conversion process in order to counter unforeseen stoppages/problems that may arise suddenly throughout the unit (team).	He/she is not (yet) competent at shifting critical resources between different components of our unit's (team's) conversion process in order to counter unforeseen stoppages/problems that may arise throughout the unit (team).	He/she is able to adequately shift critical material resources between different components of our unit's (team's) conversion process in order to counter unforeseen stoppages/problem that may arise in certain areas of the unit (team).	He/she is quite astute at shifting critical material resources between different components of our unit's (team's) conversion process in order to counter unforeseen stoppages/problem that may arise in certain areas of the unit (team).	He/she is an expert at shifting critical material resources between different components of our unit's (team's) conversion process in order to counter unforeseen stoppages/problems that may arise in certain areas of the unit (team).	<b>6</b>
<b>I3</b>	<b>Balancing human resources</b>	He/she does not even know where to start if asked to shift human resources between different components of our unit's (team's) conversion process in order to counter unforeseen stoppages/problems that may arise suddenly throughout the unit (team).	He/she is not (yet) competent at shifting human resources between different components of our unit's (team's) conversion process in order to counter unforeseen stoppages/problems that may arise throughout the unit (team).	He/she is able to adequately shift human resources between different components of the unit's (team's) conversion process in order to counter unforeseen stoppages/problem that may arise in certain areas of the unit (team).	He/she is quite astute at shifting human resources between different components of our unit's (team's) conversion process in order to counter unforeseen stoppages/problems that may arise in certain areas of the unit (team).	He/she is an expert at shifting human resources between different components of our unit's (team's) conversion process in order to counter unforeseen stoppages/problems that may arise in certain areas of the unit (team).	<b>6</b>
<b>I4</b>	<b>Quality assurance</b>	He/she does not even know where to start if asked to manage and quality assure our unit's (team's) conversion process so as to ensure the optimal delivery speed, quality and cost-efficiency of our unit's (team's) products/services.	He/she is not (yet) competent at quality assuring the unit's (team's) conversion process so as to ensure the optimal delivery speed, quality and cost-efficiency of our unit's (team's) products/services.	He/she is able to adequately manage our unit's (team's) conversion process so as to ensure the optimal delivery speed, quality and cost-efficiency of our unit's (team's) products/services.	He/she is quite astute at managing our unit's (team's) conversion process so as to ensure the optimal delivery speed, quality and cost-efficiency of our unit's products/services.	He/she is able to expertly "orchestrate" our unit's conversion process so as to ensure the optimal delivery speed, quality and cost-efficiency of our unit's (team's) products/services.	<b>6</b>

15	<b>Correcting faults</b>	If you would ask him/her to identify and correct any (surfacing) faults in the unit's (team's) conversion process, he/she would not even know where to start looking.	He/she is no (yet) fully competent at identifying and correcting any (surfacing) faults in the unit's (team's) conversion process.	He/she is capable of identifying and correcting faults in the unit's (team's) conversion process in real-time.	He/she is quite astute at identifying and correcting faults in the unit's (team's) conversion process in real-time.	He/she is an expert in identifying and correcting faults in the unit's (team's) conversion process in real-time.	6
16	<b>Managing risk</b>	If you would ask him/her to adapt in real-time and manage surfacing risk in the unit's (team's) conversion process, he/she would not know where to start.	He/she is not (yet) fully competent at adaptation and the management of surfacing risk in the unit's (team's) conversion process.	He/she is relatively competent at adaptation and the management of surfacing risk in the unit's (team's) conversion process.	He/she is astute at adaptation and the management of surfacing risk in the unit's (team's) conversion process.	He/she is highly competent at adaptation and the management of surfacing risk in the unit's (team's) conversion process.	6
17	<b>Process adaptation</b>	If you had to ask him/her to make recalibrations to the performance process of the unit (team) and implement short-term solutions to ensure the successful completion of a current performance cycle in real-time, he/she would not know where to start.	He/she is not (yet) competent at making recalibrations to the performance process of the unit (team) and implementing short-term solutions to ensure the successful completion of a current performance cycle in real-time.	He/she is relatively competent at making recalibrations to the performance process of the unit (team) and implementing short-term solutions to ensure the successful completion of a current performance cycle in real-time.	He/she is astute at making recalibrations to the performance process of the unit (team) and implementing short-term solutions to ensure the successful completion of a current performance cycle in real-time.	He/she is an expert at making recalibrations to the performance process of the unit (team) and implementing short-term solutions to ensure the successful completion of a current performance cycle in real-time.	6
18	<b>Component integration</b>	If you had to ask him/her to integrate disparate and differentiated workflow actions/component in concert with the necessary temporal pacing in order to ensure on-time product/service delivery in my unit (team), he/she would not know where to start.	He/she is not (yet) competent at integrating disparate and differentiated workflow actions/components in concert with the necessary temporal pacing in order to ensure on-time product/service delivery in the unit (team).	Under normal conditions, he/she is capable of integrating disparate and differentiated workflow actions/components in concert with the necessary temporal pacing in order to ensure on-time product/service delivery in the unit (team).	Under most conditions, he/she is astute at integrating disparate and differentiated workflow actions/components in concert with temporal pacing in order to ensure on-time product/service delivery in the unit (team).	He/she is an expert at integrating disparate and differentiated workflow actions/components in concert with the necessary temporal pacing in order to ensure on-time product/service delivery in the unit (team).	6
19	<b>Experiential learning</b>	If you had to ask him/her to verbalise and coach others on the reasons for why coordination broke down in a specific performance cycle, he/she would not know where to start.	He/she is not (yet) competent at analysing the reasons for why coordination broke down in a performance cycle and at coaching others how to avoid the same pitfalls in future.	He/she is capable of analysing the reasons for why coordination broke down in a performance cycle and coaching others how to avoid the same pitfalls in future.	He/she is astute at analysing the reasons for why coordination broke down in a performance cycle and coaching others how to avoid the same pitfalls in future.	He/she is an expert at analysing breakdowns in coordination in the unit (team) and utilising reasons for coordination breakdown as part of an <i>experiential learning experience</i> to others.	6
110	<b>Situational updates</b>	He/she does not ever provide situational updates (i.e. how effectively and efficiently the current performance cycle is operating) to other members in the unit (team).	He/she rarely provides situational updates (i.e. how effectively and efficiently the current performance cycle is operating) to other members in the unit (team).	He/she provides situational updates (i.e. how effectively and efficiently the current performance cycle is operating) to other members in the unit (team), but mostly only when things are going as planned.	He/she regularly provides situational updates (i.e. how effectively and efficiently the current performance cycle is operating) to other members in the unit (team), even when things are not going as planned.	He/she provides continuous situational updates (i.e. how effectively and efficiently the current performance cycle is operating) to other members in the unit (team) regardless of the circumstances.	6

**APPENDIX C**  
**SAGEA MEMBER ORGANISATIONS**

Absa Group Ltd  
Accenture  
Adams & Adams  
AECI  
AFGRI  
Afrox  
AIG Insurance  
Allan Gray  
Allen & Overy (South Africa) LLPP  
Anglo American  
Anglo American Thermal Coal  
Anglo Platinum  
Aurecon  
AVI Limited  
Bain & Company  
Baker & McKenzie  
Barloworld Logistics  
Barloworld Transport  
BDO  
Beiersdorf  
Bloomberg LP  
BMW  
Bowman Gilfillan Inc.  
Brandhouse Beverages (Pty) Ltd  
British American Tobacco  
Cisco  
Citi  
Clicks Group Limited  
Coronation Fund Manager  
CSIR  
Cummins  
Deloitte  
Deloitte Consulting  
Denel Dynamics  
Derivco  
Deutsche Bank  
Dimension Data  
Direct Axis  
Discovery  
Distell  
Edward Nathan Sonnenbergs  
Emerson Network Power  
EOH  
Ericsson  
Ernst & Young  
Estee Lauder Companies  
Evraz Highveld Steel and Vanadium  
Exxaro Resources Ltd  
Fasken Martineau  
Faurecia  
Financial Intelligence Centre  
First National Bank  
FirstRand

Frost & Sullivan  
Genesis Analytics  
GlencoreXstrata Plc  
Global Load Control  
Goodyear  
Grant Thornton  
HatchGobal  
Hogan Lovells (South Africa) incorporated as Routledge Modise Inc.  
HSBC Bank  
IDM Group  
Investec Asset Management  
Investec Bank  
IQ Business  
J P Morgan Chase Bank  
JSE  
Kansai Plascon  
KPMG Inc.  
Kellogg Company of SA  
LexisNexis  
Mazars  
Marsh  
Massmart Services  
Media24  
McKinsey & Co.  
Mercedes-Benz South Africa  
Merrill Lynch South Africa  
MMI Holdings  
Mr Price Group  
MTN  
Multichoice  
Murray & Roberts Limited  
Nampak Management Services  
Nedbank Limited  
Nestle  
Norton Rose South Africa  
Old Mutual  
Orica  
Pernod Ricard  
Polyoak Packaging  
PricewaterhouseCoopers Inc  
Professional Provident Society Insurance Company Limited  
Psybergate  
PSG Konsult  
Public Investment Corporation  
Puma Energy  
Rainbow Chicken Limited  
Rand Merchant Bank  
Reckitt Benckiser  
Rio Tinto  
Royal Swaziland Sugar Corporation  
Sanlam  
Saratoga Software  
Sasol  
Seeff

Senwes  
Shoprite Checkers  
South32  
South African Breweries Limited  
Tongaat Hulett  
Truworths  
South African Revenue Services  
Standard Bank Limited  
Teach South Africa  
TFG The Foschini Retail Group (Pty) Ltd  
The Boston Consulting Group  
The Innovation Hub  
Tiger Brands  
Toyota South Africa  
Unilever  
Vodacom  
Volkswagen of South Africa  
Webber Wentzel  
Weir Minerals Africa  
Werksmans Attorneys  
WSP Group

Membership list available from: <https://sagea.org.za/about/>



**APPENDIX D**  
**INSTITUTIONAL PERMISSION FORM**



UNIVERSITEIT • STELLENBOSCH • UNIVERSITY  
jou kennisvennoot • your knowledge partner

## INSTITUTIONAL PERMISSION TO PARTICIPATE IN RESEARCH

---

### **The development and psychometric evaluation of a graduate leader competency questionnaire**

To whom it may concern

#### **Letter requesting permission for a research study to be conducted within your organisation.**

The purpose of this letter is to kindly ask your organisation to partake in a research study conducted by Jacques Pienaar, a PhD student in Industrial Psychology at Stellenbosch University. The purpose of this research study is to develop and empirically validate a graduate competency questionnaire that will provide a valid answer to the research-initiating questions of what graduate (leader) performance means and how graduate (leader) performance can be validly measured in the South African context.

It is anticipated that the results of my research will not only be valuable for personal academic reasons, but also for your company and your graduate (recruitment) initiatives. This is a step towards gathering more information on complex human behaviour and especially the reasons for why graduate (leader) performance varies. Understanding this type of behaviour could contribute to identifying and developing the next generation of graduate leaders.

We hereby request permission to conduct our research within your organisation. The Pienaar Graduate Leader Competency Questionnaire (PGLCQ) will be administered for the purpose of the study, via the Stellenbosch University web-based e-Survey service (SURveys). Preceding this, will be short contact sessions with a representative (or the head) of your (Graduate) Recruitment team in order to develop the PGLCQ. For this reason, I will require the name and contact details of the person you designate as a subject-matter expert in your organisation for this purpose. If your organisation agrees to participate, I will firstly contact this person independently and he or she will still have the opportunity to decide whether he or she wants to participate in this study as well.

If your organisation would agree to participate in the research, I will secondly also require the names and contact details of all of the graduate trainees (as well as their direct supervisors or managers) that you nominate for involvement in this study. This is necessary as the study aims to collect multi-rater data (i.e. self-ratings from graduates and 'other' ratings from their managers) to more comprehensively validate the PGLCQ from different perspectives. Should your organisation agree to participate, I will also contact these designated individuals independently and ask for their consent to participate in the study as well. Participants (graduates and their direct supervisors) can therefore also choose whether to participate in this study or not. Any volunteers to this study may withdraw at any time without consequences of any kind. Participants are not waiving any legal claims, rights or remedies because of their participation in this research study.

Should your organisation be willing to participate, I will contact a representative or subject matter expert (as per your instruction at the end of this document) in your (Graduate) Recruitment team shortly and set up the first sequence of contact sessions. The purpose of these sessions is to gather information on what graduate (leader) performance means in your specific work environment. This information will also be used to develop the initial version (i.e. the items or questions) of the PGLCQ.

At a later stage and after the questionnaire is developed, I will forward all graduates (and their managers) who you have nominated and who have consented to participate in the study a link to the online version of the questionnaire. The questionnaire consists of nine sections and will take approximately 30 minutes for both the self-rater (i.e. the graduate) and the direct superior (i.e. the graduate's manager) to complete. Depending on the unique way in which you develop, rotate and place graduates within your organisation, this could mean that the same direct superior could be involved in the rating of more than one graduate under his or her supervision.

Any information that is obtained during the course of this study and that can be associated with or linked to specific participant responses will remain confidential and will be disclosed only with their permission or as required by law. Confidentiality will be maintained by means of restricting access to data to the researchers (Jacques Pienaar and Professor Callie Theron) only. The data will be stored on a password-protected computer. Only aggregate statistics of the sample will be reported and disseminated. The identity of the participants will never be revealed. The identity of the participating organisation will also not be revealed.

If you have any questions or concerns about the research, please feel free to contact Jacques Pienaar (083 236 4108 or [jacquespienaarorama@gmail.com](mailto:jacquespienaarorama@gmail.com)) or Professor Callie Theron of the Department of Industrial Psychology of Stellenbosch University (084 273 4139 or [ccth@sun.ac.za](mailto:ccth@sun.ac.za)). As a participant organisation to the study, I will also be more than happy to provide you with more detailed information regarding the study's results when it has been completed that you can use as input to your graduate recruitment and development initiatives.

We trust that you will kindly grant us the institutional permission to conduct our study in your organisation. Thank you in advance.

Kind regards,  
Jacques Pienaar & Prof Callie Theron

---

I \_\_\_\_\_ [name of organisational representative] hereby give institutional permission for Jacques Pienaar and Prof Callie Theron to conduct their PGCQ research study at \_\_\_\_\_ [name of organisation] in accordance with the research proposal that was submitted. If the research will substantially deviate from the undertaking given in the research proposal the undersigned will be informed.

Name and contact details of the representative that we designate as a subject matter expert on this topic on behalf our organisation and who can provide you with the names and contact details of the graduates (and their managers) who we will nominate for involvement in this study:

Name: \_\_\_\_\_  
Position: \_\_\_\_\_  
Tel: \_\_\_\_\_  
E-mail: \_\_\_\_\_

Signature: \_\_\_\_\_ Date: \_\_\_\_\_

**APPENDIX E**  
**(ONLINE QUALITATIVE SURVEY)**

## CONSENT TO PARTICIPATE IN RESEARCH (SHORT SURVEY)

Dear prospective research participant

### The development and psychometric evaluation of a graduate leader competency questionnaire

My name is Jacques Pienaar, a student at the Department of Industrial Psychology at the University of Stellenbosch, and I would like to invite you to take part in a study, the results of which will contribute to a research project in order for me to complete my PhD dissertation. Please take some time to read the information presented here, which will explain the details of this project. Although your organization has already given me permission to conduct the research at your company, your participation is entirely voluntary and you are free to decline to participate. If you say no, this will not affect you negatively in any way whatsoever. You are also free to withdraw from the study at any point, even if you do agree to take part in the study now.

The purpose of the study is to develop an instrument for measuring graduate (leader-in-training) performance. In order to do so, I am conducting a short survey with subject-matter experts in the field of graduate recruitment and development in order to collect/tap their expert opinions on this topic. The survey will comprise of several questions that will be posed to you as a subject matter expert. All questions pertain to your views on what graduate (leader-in-training) performance means and the competencies that you deem necessary for graduates to become high performance leaders.

Your information and responses to the online survey will be kept confidential. Except for myself, only my supervisor will have access to the survey data and my records of your answers. I will not include your personal information in these records that I store in the data file. The data file will also be kept secure on a password-protected computer. Only aggregated statistics of your responses (along with that of others) will be reported and disseminated. The identities of participants will never be revealed. The identity of participating organisations will also not be revealed.

If you have any questions or concerns about the research, please feel free to contact Jacques Pienaar (083 236 4108 or [jacquespienaarorama@gmail.com](mailto:jacquespienaarorama@gmail.com)) or Prof Callie Theron of the Department of Industrial Psychology at Stellenbosch University (084 273 4139 or [ccth@sun.ac.za](mailto:ccth@sun.ac.za)). Please save a copy of this form on your computer for future referral.

<b>I confirm that I have read and understood the information provided for the current study.</b>	YES	NO
	<input type="checkbox"/>	<input type="checkbox"/>
<b>I agree to take part in this survey.</b>	YES	NO
	<input type="checkbox"/>	<input type="checkbox"/>

## THE DEVELOPMENT AND PSYCHOMETRIC EVALUATION OF A GRADUATE COMPETENCY QUESTIONNAIRE

## SURVEY OF THE RELEVANCE/IMPORTANCE OF SPECIFIC SECOND-ORDER GRADUATE (LEADER) COMPETENCIES

Please answer the questions provided below to the best of your ability as a subject-matter expert in the area of graduate (leader) selection/development/performance.

\* 1.

On a scale from 1-5 please indicate your opinion on the degree of relevance that the competency defined below holds for the evaluation of the performance of graduates (as future leaders) in South African business. Please select your response from the drop box below:

Highly relevant

Moderately relevant

Relevant

Marginally relevant

Irrelevant

COMPETENCY 1: CREATES AN EXCITING AND ASPIRATIONAL VISION FOR THE UNIT

***The extent to which the graduate leader attracts and rallies a wide follower base towards an inspiring and exciting future vision of what can be achieved and how their lives can be fulfilled and become more meaningful by joining and investing in such a cause.***

2.

6

On a scale from 1-5 please indicate your opinion on the degree of relevance that the competency defined below holds for the evaluation of the performance of graduates (as future leaders) in South African business. Please select your response from the drop box below:

- Highly relevant
- Moderately relevant
- Relevant
- Marginally relevant
- Irrelevant

## COMPETENCY 2: STRENGTHENS AND ENABLES OTHERS

***The extent to which the graduate leader raises the confidence and performance capabilities of followers towards success and high levels of achievement.***

3. On a scale from 1-5 please indicate your opinion on the degree of relevance that the competency defined below holds for the evaluation of the performance of graduates (as future leaders) in South African business. Please select your response from the drop box below:

6

- Highly relevant
- Moderately relevant
- Relevant
- Marginally relevant
- Irrelevant

## COMPETENCY 3: ANALYSES AND UNDERSTANDS THE INTERNAL AND EXTERNAL WORK UNIT ENVIRONMENT

***The extent to which the graduate leader systematically surveys and immerses themselves in the internal and external environment of the unit to collect and interpret information about critical occurrences or conditions on behalf of the unit as input to performance planning.***

4. On a scale from 1-5 please indicate your opinion on the degree of relevance that the competency defined below holds for the evaluation of the performance of graduates (as future leaders) in South African business. Please select your response from the drop box below:

Highly relevant  
Moderately relevant  
Relevant  
Marginally relevant  
Irrelevant

#### COMPETENCY 4: DEVELOPS UNIT COMPETITIVENESS

***The extent to which the graduate leader develops and secures resources for exploiting viable, eco-friendly and sustainable opportunities necessary for the occupation of a morally superior, winning market position for the unit.***

5. On a scale from 1-5 please indicate your opinion on the degree of relevance that the competency defined below holds for the evaluation of the performance of graduates (as future leaders) in South African business. Please select your response from the drop box below:

Highly relevant  
Moderately relevant  
Relevant  
Marginally relevant  
Irrelevant

#### COMPETENCY 5: INVOLVES FOLLOWERS AND ELICITS PARTICIPATION

***The extent to which the graduate leader provides scope and opportunities for followers to spontaneously contribute their talents/capabilities to the unit's operations.***



6. On a scale from 1-5 please indicate your opinion on the degree of relevance that the competency defined below holds for the evaluation of the performance of graduates (as future leaders) in South African business. Please select your response from the drop box below:

- Highly relevant
- Moderately relevant
- Relevant
- Marginally relevant
- Irrelevant

#### COMPETENCY 6: ENTRENCHES A HIGH PERFORMANCE CULTURE IN THE UNIT

***The extent to which the graduate leader consistently behaves and makes decisions in a manner that serves the human condition by eliciting positively valenced psychological functioning in followers.***

7. On a scale from 1-5 please indicate your opinion on the degree of relevance that the competency defined below holds for the evaluation of the performance of graduates (as future leaders) in South African business. Please select your response from the drop box below:

- Highly relevant
- Moderately relevant
- Relevant
- Marginally relevant
- Irrelevant

#### COMPETENCY 7: UNITES AND CONNECTS FOLLOWERS

***The extent to which the graduate leader brings followers together and unites them in fortified, mutually supportive relationships in the work unit.***

8. On a scale from 1-5 please indicate your opinion on the degree of relevance that the competency defined below holds for the evaluation of the performance of graduates (as future leaders) in South African business. Please select your response from the drop box below:

- Highly relevant
- Moderately relevant
- Relevant
- Marginally relevant
- Irrelevant

#### COMPETENCY 8: MANAGES THE INTERNAL WORK UNIT ENVIRONMENT

***The extent to which the graduate leader maintains a hands-off procedural view and executes in-process corrections as and when required to ensure that different components of the conversion process (value chain) keeps pulling in the same direction.***

9. On a scale from 1-5 please indicate your opinion on the degree of relevance that the competency defined below holds for the evaluation of the performance of graduates (as future leaders) in South African business. Please select your response from the drop box below:

- Highly relevant
- Moderately relevant
- Relevant
- Marginally relevant
- Irrelevant

#### COMPETENCY 9: DISPLAYS PERSONAL PROFICIENCY

***The extent to which the graduate leader functions as a well-rounded, sought-after and high impact resource in the unit.***

10. Does all of the second-order competencies cited above sufficiently cover the (future) graduate leader performance domain or are there additional (umbrella) second-order competencies that are relevant and not covered here at all?

If all of the important (future) graduate leader competencies are not covered here, please list one or more additional competencies that you deem critical to (future) graduate leader performance along with their definitions/meaning in the space provided below.

**APPENDIX F**  
**INFORMED CONSENT (INTERVIEWS)**

## CONSENT TO PARTICIPATE IN RESEARCH (SHORT INTERVIEWS)

Dear research participant

### The development and psychometric evaluation of a graduate leader competency questionnaire

Please take some time to read the information presented here, which will explain the next step in this research project. Your participation here again is entirely voluntary and you are free to decline to participate. If you say no, this will not affect you negatively in any way whatsoever. You are also free to withdraw from the study at any point, even if you do agree to take part in the study now.

Following the survey you have already completed, the second step in the process involves short contact sessions with subject matter experts in the field of graduate recruitment and development in order to further collect/tap your expert opinions on this topic. The contact sessions will pose a number of different questions regarding the graduate (leader-in-training) competencies that was under scrutiny in the short survey that you have already completed. During these contact sessions (or interviews), you will be asked to provide examples of behaviors that you feel provide an expression of mastery or high level of competence in the competencies that was covered in the survey. More specifically, you will be asked to provide specific examples of graduate (leaders-in-training) behaviors that you have observed in your time in industry that makes you believe that a specific individual has mastered a specific competency. Your responses to these questions are critical in developing an item pool (i.e. questions) for a questionnaire that can be used to evaluate/assess graduate (leader-in-training) competencies. Depending on circumstances, these contact sessions (or interviews) can last up to 45 minutes.

Your information and responses to the questions in the interview will be kept confidential. Except for myself, only my supervisor will have access to the records of your answers. I will not include your personal information in these records that I will translate and store in a data file. The data file will also be kept secure on a password-protected computer. Only aggregated statistics of your responses (along with that of others) will be reported and disseminated. The identities of participants will never be revealed. The identity of participating organisations will also not be revealed.

If you have any questions or concerns about the research, please feel free to contact Jacques Pienaar (083 236 4108 or [jacquespienaarorama@gmail.com](mailto:jacquespienaarorama@gmail.com)) or Prof Callie Theron of the Department of Industrial Psychology at Stellenbosch University (084 273 4139 or [ccth@sun.ac.za](mailto:ccth@sun.ac.za)). Please save a copy of this form on your computer for future referral.

<b>I confirm that I have read and understood the information provided.</b>	YES	NO
	<input type="checkbox"/>	<input type="checkbox"/>
<b>I agree to take part in this contact (interview) session.</b>	YES	NO
	<input type="checkbox"/>	<input type="checkbox"/>

**APPENDIX G**  
**ITEM DESCRIPTIVE STATISTICS**

Item	Mean	Median	Mode	Std. Deviation	Variance	Skewness	Std. Error of Skewness	Kurtosis	Std. Error of Kurtosis	Z skewness	Z kurtosis	# Sig skewness	# Sig kurtosis	# Positive skew	# Negative skew	# Leptokurtic	# Platikurtic	# Mesokurtic
Q13	4.28000	4.00000	4.000	0.711000	0.505	-0.590	0.210	-0.342	0.417	-2.80952381	-0.820143885	1	0	0	1	0	0	1
Q14	3.79000	4.00000	4.000	1.000000	1.001	-0.625	0.210	-0.045	0.417	-2.97619048	-0.107913669	1	0	0	1	0	0	1
Q15	3.81000	4.00000	4.000	0.809000	0.654	-0.254	0.210	0.036	0.417	-1.20952381	0.086330935	0	0	0	0	0	0	1
Q16	3.22000	3.00000	3.000	1.054000	1.111	-0.291	0.210	-0.414	0.417	-1.38571429	-0.992805755	0	0	0	0	0	0	1
Q17	3.91000	4.00000	4.000	0.811000	0.658	-0.351	0.210	-0.382	0.417	-1.67142857	-0.916067146	0	0	0	0	0	0	1
Q18	3.85000	4.00000	4.000	0.965000	0.932	-0.565	0.210	0.086	0.417	-2.69047619	0.206235012	1	0	0	1	0	0	1
Q19	3.61000	4.00000	4.000	0.860000	0.740	-0.091	0.210	-0.613	0.417	-0.43333333	-1.470023981	0	0	0	0	0	0	1
Q20	3.68000	4.00000	4.000	0.856000	0.733	-0.443	0.210	0.372	0.417	-2.10952381	0.892086331	1	0	0	1	0	0	1
Q21	3.68000	4.00000	4.000	0.856000	0.733	-0.517	0.210	0.791	0.417	-2.46190476	1.896882494	1	0	0	1	0	0	1
Q22	3.82000	4.00000	4.000	0.796000	0.634	-0.304	0.210	0.189	0.417	-1.44761905	0.45323741	0	0	0	0	0	0	1
Q24	3.32000	3.00000	3.000	1.105000	1.220	-0.124	0.210	-0.362	0.417	-0.59047619	-0.868105516	0	0	0	0	0	0	1
Q25	3.39000	3.00000	3.000	0.911000	0.831	0.238	0.210	-0.431	0.417	1.13333333	-1.033573141	0	0	0	0	0	0	1
Q26	3.44000	3.00000	3.000	1.061000	1.127	-0.255	0.210	-0.542	0.417	-1.21428571	-1.299760192	0	0	0	0	0	0	1
Q27	3.61000	4.00000	3.000	0.824000	0.679	0.180	0.210	-0.644	0.417	0.857142857	-1.544364508	0	0	0	0	0	0	1
Q28	3.50000	3.00000	3.000	0.858000	0.737	0.012	0.210	0.090	0.417	0.057142857	0.215827338	0	0	0	0	0	0	1
Q29	3.80000	4.00000	4.000	0.908000	0.825	-0.278	0.210	-0.465	0.417	-1.32380952	-1.115107914	0	0	0	0	0	0	1
Q30	3.56000	4.00000	3.000	0.847000	0.717	-0.089	0.210	-0.193	0.417	-0.42380952	-0.462829736	0	0	0	0	0	0	1
Q31	3.59000	4.00000	4.000	0.897000	0.805	-0.040	0.210	-0.747	0.417	-0.19047619	-1.791366906	0	0	0	0	0	0	1
Q32	3.86000	4.00000	3.000	0.928000	0.860	-0.362	0.210	-0.251	0.417	-1.72380952	-0.601918465	0	0	0	0	0	0	1
Q33	3.70000	4.00000	4.000	0.945000	0.894	-0.236	0.210	-0.591	0.417	-1.12380952	-1.417266187	0	0	0	0	0	0	1
Q35	3.44000	4.00000	4.000	0.941000	0.885	-0.278	0.210	-0.465	0.417	-1.32380952	-1.115107914	0	0	0	0	0	0	1
Q36	3.44000	3.00000	3.000	0.865000	0.749	0.070	0.210	-0.287	0.417	0.33333333	-0.6882494	0	0	0	0	0	0	1
Q37	3.35000	3.00000	3.000	0.914000	0.836	-0.160	0.210	-0.160	0.417	-0.76190476	-0.383693046	0	0	0	0	0	0	1
Q38	3.51000	4.00000	4.000	0.867000	0.752	-0.212	0.210	-0.291	0.417	-1.00952381	-0.697841727	0	0	0	0	0	0	1
Q39	3.25000	3.00000	3.000	0.811000	0.658	-0.312	0.210	0.228	0.417	-1.48571429	0.54676259	0	0	0	0	0	0	1
Q40	3.29000	3.00000	3.000	0.858000	0.736	-0.004	0.210	-0.084	0.417	-0.01904762	-0.201438849	0	0	0	0	0	0	1
Q41	3.39000	3.00000	3.000	0.860000	0.740	-0.054	0.210	0.006	0.417	-0.25714286	0.014388489	0	0	0	0	0	0	1







Q105	3.63000	4.00000	4.000	0.830000	0.689	-0.267	0.210	-0.410	0.417	-1.27142857	-0.983213429	0	0	0	0	0	0	1
Q106	3.52000	4.00000	4.000	0.849000	0.721	-0.323	0.210	0.178	0.417	-1.53809524	0.426858513	0	0	0	0	0	0	1
Q107	3.55000	4.00000	3.000	0.821000	0.674	0.091	0.210	-0.524	0.417	0.433333333	-1.256594724	0	0	0	0	0	0	1
Q108	3.30000	3.00000	3.000	0.807000	0.651	0.363	0.210	0.228	0.417	1.728571429	0.54676259	0	0	0	0	0	0	1
Q109	3.38000	3.00000	4.000	0.831000	0.691	-0.561	0.210	0.270	0.417	-2.67142857	0.647482014	1	0	0	1	0	0	1
Q110	3.64000	4.00000	4.000	0.948000	0.899	-0.462	0.210	0.020	0.417	-2.2	0.047961631	1	0	0	1	0	0	1
SUM												13	3	0	13	2	1	87
%												14.444444	3.33333	0	14.44444	2.22222222	1.1111111	96.666666
												4	3		2	11	7	



**APPENDIX H**  
**GOODNESS OF FIT STATISTICS FOR THE PGLCQ MEASUREMENT**  
**MODELS**

## Competency A

The displays personal leader proficiency measurement model

---



---

Goodness of Fit Statistics

Degrees of Freedom = 35

Minimum Fit Function Chi-Square = 61.8822 (P = .003371)

Normal Theory Weighted Least Squares Chi-Square = 59.4827 (P = .006050)

Satorra-Bentler Scaled Chi-Square = 52.5644 (P = .02860)

Chi-Square Corrected for Non-Normality = 100.3632 (P = .0000)

Estimated Non-centrality Parameter (NCP) = 17.5644

90 Percent Confidence Interval for NCP = (1.9593 ; 41.1245)

Minimum Fit Function Value = .4688

Population Discrepancy Function Value (F0) = .1331

90 Percent Confidence Interval for F0 = (.01484 ; .3115)

Root Mean Square Error of Approximation (RMSEA) = .06166

90 Percent Confidence Interval for RMSEA = (.02059 ; .09435)

P-Value for Test of Close Fit (RMSEA < .05) = .2711

Expected Cross-Validation Index (ECVI) = .7012

90 Percent Confidence Interval for ECVI = (.5830 ; .8797)

ECVI for Saturated Model = .8333

ECVI for Independence Model = 6.4866

Chi-Square for Independence Model with 45 Degrees of Freedom = 836.2372

Independence AIC = 856.2372

Model AIC = 92.5644

Saturated AIC = 110.0000

Independence CAIC = 895.1407

Model CAIC = 170.3713

Saturated CAIC = 323.9692

Normed Fit Index (NFI) = .9371

Non-Normed Fit Index (NNFI) = .9715

Parsimony Normed Fit Index (PNFI) = .7289

Comparative Fit Index (CFI) = .9778

Incremental Fit Index (IFI) = .9781

Relative Fit Index (RFI) = .9192

Critical N (CN) = 144.9989

Root Mean Square Residual (RMR) = .03995

Standardized RMR = .05702

Goodness of Fit Index (GFI) = .9173

Adjusted Goodness of Fit Index (AGFI) = .8701

Parsimony Goodness of Fit Index (PGFI) = .5838

---

## Competency B

The analyses and understands the external and internal work unit environment measurement model

---

 Goodness of Fit Statistics
 

---

Degrees of Freedom = 35

Minimum Fit Function Chi-Square = 53.5061 (P = .02344)

Normal Theory Weighted Least Squares Chi-Square = 50.5926 (P = .04278)

Satorra-Bentler Scaled Chi-Square = 46.6558 (P = .09000)

Chi-Square Corrected for Non-Normality = 81.2389 (P = .0000)

Estimated Non-centrality Parameter (NCP) = 11.6558

90 Percent Confidence Interval for NCP = (.0 ; 33.5553)

Minimum Fit Function Value = .4053

Population Discrepancy Function Value (F0) = .08830

90 Percent Confidence Interval for F0 = (.0 ; .2542)

Root Mean Square Error of Approximation (RMSEA) = .05023

90 Percent Confidence Interval for RMSEA = (.0 ; .08522)

P-Value for Test of Close Fit (RMSEA &lt; .05) = .4665

Expected Cross-Validation Index (ECVI) = .6565

90 Percent Confidence Interval for ECVI = (.5682 ; .8224)

ECVI for Saturated Model = .8333

ECVI for Independence Model = 9.7539

Chi-Square for Independence Model with 45 Degrees of Freedom = 1267.5109

Independence AIC = 1287.5109

Model AIC = 86.6558

Saturated AIC = 110.0000

Independence CAIC = 1326.4144

Model CAIC = 164.4628

Saturated CAIC = 323.9692

Normed Fit Index (NFI) = .9632

Non-Normed Fit Index (NNFI) = .9877

Parsimony Normed Fit Index (PNFI) = .7491

Comparative Fit Index (CFI) = .9905

Incremental Fit Index (IFI) = .9905

Relative Fit Index (RFI) = .9527

Critical N (CN) = 163.2352

Root Mean Square Residual (RMR) = .04177

Standardized RMR = .04776

Goodness of Fit Index (GFI) = .9288

Adjusted Goodness of Fit Index (AGFI) = .8881

Parsimony Goodness of Fit Index (PGFI) = .5911
 

---

## Competency C

*The creates an exciting and aspirational vision for the unit measurement model*

---



---

Goodness of Fit Statistics
Degrees of Freedom = 35
Minimum Fit Function Chi-Square = 67.5749 (P = .0007754)
Normal Theory Weighted Least Squares Chi-Square = 59.2584 (P = .006382)
Satorra-Bentler Scaled Chi-Square = 41.5941 (P = .2055)
Chi-Square Corrected for Non-Normality = 63.9667 (P = .001994)
Estimated Non-centrality Parameter (NCP) = 6.5941
90 Percent Confidence Interval for NCP = (.0 ; 26.9451)
Minimum Fit Function Value = .5119
Population Discrepancy Function Value (F0) = .04996
90 Percent Confidence Interval for F0 = (.0 ; .2041)
Root Mean Square Error of Approximation (RMSEA) = .03778
90 Percent Confidence Interval for RMSEA = (.0 ; .07637)
P-Value for Test of Close Fit (RMSEA < .05) = .6558
Expected Cross-Validation Index (ECVI) = .6181
90 Percent Confidence Interval for ECVI = (.5682 ; .7723)
ECVI for Saturated Model = .8333
ECVI for Independence Model = 13.2528
Chi-Square for Independence Model with 45 Degrees of Freedom = 1729.3633
Independence AIC = 1749.3633
Model AIC = 81.5941
Saturated AIC = 110.0000
Independence CAIC = 1788.2668
Model CAIC = 159.4010
Saturated CAIC = 323.9692
Normed Fit Index (NFI) = .9759
Non-Normed Fit Index (NNFI) = .9950
Parsimony Normed Fit Index (PNFI) = .7591
Comparative Fit Index (CFI) = .9961
Incremental Fit Index (IFI) = .9961
Relative Fit Index (RFI) = .9691
Critical N (CN) = 182.9782
Root Mean Square Residual (RMR) = .03685
Standardized RMR = .04273
Goodness of Fit Index (GFI) = .9176
Adjusted Goodness of Fit Index (AGFI) = .8705
Parsimony Goodness of Fit Index (PGFI) = .5839

---

## Competency D

The *entrenches a high-performance culture in the unit* measurement model

---



---

 Goodness of Fit Statistics
 

---

Degrees of Freedom = 35

Minimum Fit Function Chi-Square = 56.4937 (P = .01214)

Normal Theory Weighted Least Squares Chi-Square = 54.6825 (P = .01818)

Satorra-Bentler Scaled Chi-Square = 45.6518 (P = .1073)

Chi-Square Corrected for Non-Normality = 84.3265 (P = .0000)

Estimated Non-centrality Parameter (NCP) = 10.6518

90 Percent Confidence Interval for NCP = (.0 ; 32.2544)

Minimum Fit Function Value = .4280

Population Discrepancy Function Value (F0) = .08070

90 Percent Confidence Interval for F0 = (.0 ; .2444)

Root Mean Square Error of Approximation (RMSEA) = .04802

90 Percent Confidence Interval for RMSEA = (.0 ; .08356)

P-Value for Test of Close Fit (RMSEA &lt; .05) = .5037

Expected Cross-Validation Index (ECVI) = .6489

90 Percent Confidence Interval for ECVI = (.5682 ; .8125)

ECVI for Saturated Model = .8333

ECVI for Independence Model = 8.8017

Chi-Square for Independence Model with 45 Degrees of Freedom = 1141.8260

Independence AIC = 1161.8260

Model AIC = 85.6518

Saturated AIC = 110.0000

Independence CAIC = 1200.7295

Model CAIC = 163.4588

Saturated CAIC = 323.9692

Normed Fit Index (NFI) = .9600

Non-Normed Fit Index (NNFI) = .9875

Parsimony Normed Fit Index (PNFI) = .7467

Comparative Fit Index (CFI) = .9903

Incremental Fit Index (IFI) = .9904

Relative Fit Index (RFI) = .9486

Critical N (CN) = 166.8030

Root Mean Square Residual (RMR) = .03220

Standardized RMR = .04766

Goodness of Fit Index (GFI) = .9235

Adjusted Goodness of Fit Index (AGFI) = .8798

Parsimony Goodness of Fit Index (PGFI) = .5877
 

---

## Competency E

The first-order *develops unit competitiveness* 1-factor measurement model

---



---

Goodness of Fit Statistics
Degrees of Freedom = 35
Minimum Fit Function Chi-Square = 112.1921 (P = .00)
Normal Theory Weighted Least Squares Chi-Square = 129.1135 (P = .00)
Satorra-Bentler Scaled Chi-Square = 77.8896 (P = .0000)
Chi-Square Corrected for Non-Normality = 65.1517 (P = .001469)
Estimated Non-centrality Parameter (NCP) = 42.8896
90 Percent Confidence Interval for NCP = (21.1010 ; 72.4080)
Minimum Fit Function Value = .8499
Population Discrepancy Function Value (F0) = .3249
90 Percent Confidence Interval for F0 = (.1599 ; .5485)
Root Mean Square Error of Approximation (RMSEA) = .09635
90 Percent Confidence Interval for RMSEA = (.06758 ; .1252)
P-Value for Test of Close Fit (RMSEA < .05) = .005907
Expected Cross-Validation Index (ECVI) = .8931
90 Percent Confidence Interval for ECVI = (.7280 ; 1.1167)
ECVI for Saturated Model = .8333
ECVI for Independence Model = 10.7414
Chi-Square for Independence Model with 45 Degrees of Freedom = 1397.8615
Independence AIC = 1417.8615
Model AIC = 117.8896
Saturated AIC = 110.0000
Independence CAIC = 1456.7650
Model CAIC = 195.6965
Saturated CAIC = 323.9692
Normed Fit Index (NFI) = .9443
Non-Normed Fit Index (NNFI) = .9592
Parsimony Normed Fit Index (PNFI) = .7344
Comparative Fit Index (CFI) = .9683
Incremental Fit Index (IFI) = .9685
Relative Fit Index (RFI) = .9284
Critical N (CN) = 98.1788
Root Mean Square Residual (RMR) = .07246
Standardized RMR = .07792
Goodness of Fit Index (GFI) = .8364
Adjusted Goodness of Fit Index (AGFI) = .7429
Parsimony Goodness of Fit Index (PGFI) = .5322

---

## Competency E

The first-order *develops unit competitiveness* 2-factor measurement model

---



---

 Goodness of Fit Statistics
 

---

Degrees of Freedom = 34  
 Minimum Fit Function Chi-Square = 60.0813 (P = .003795)  
 Normal Theory Weighted Least Squares Chi-Square = 56.0964 (P = .009918)  
 Satorra-Bentler Scaled Chi-Square = 43.4462 (P = .1286)  
 Chi-Square Corrected for Non-Normality = 65.7226 (P = .0008804)  
 Estimated Non-centrality Parameter (NCP) = 9.4462  
 90 Percent Confidence Interval for NCP = (.0 ; 30.5244)  
 Minimum Fit Function Value = .4552  
 Population Discrepancy Function Value (F0) = .07156  
 90 Percent Confidence Interval for F0 = (.0 ; .2312)  
 Root Mean Square Error of Approximation (RMSEA) = .04588  
 90 Percent Confidence Interval for RMSEA = (.0 ; .08247)  
 P-Value for Test of Close Fit (RMSEA < .05) = .5371  
 Expected Cross-Validation Index (ECVI) = .6473  
 90 Percent Confidence Interval for ECVI = (.5758 ; .8070)  
 ECVI for Saturated Model = .8333  
 ECVI for Independence Model = 10.7414  
 Chi-Square for Independence Model with 45 Degrees of Freedom = 1397.8615  
 Independence AIC = 1417.8615  
 Model AIC = 85.4462  
 Saturated AIC = 110.0000  
 Independence CAIC = 1456.7650  
 Model CAIC = 167.1436  
 Saturated CAIC = 323.9692  
 Normed Fit Index (NFI) = .9689  
 Non-Normed Fit Index (NNFI) = .9908  
 Parsimony Normed Fit Index (PNFI) = .7321  
 Comparative Fit Index (CFI) = .9930  
 Incremental Fit Index (IFI) = .9931  
 Relative Fit Index (RFI) = .9589  
 Critical N (CN) = 171.3274  
 Root Mean Square Residual (RMR) = .05122  
 Standardized RMR = .05528  
 Goodness of Fit Index (GFI) = .9217  
 Adjusted Goodness of Fit Index (AGFI) = .8733  
 Parsimony Goodness of Fit Index (PGFI) = .5698

---



## Competency E

The second-order *develops unit competitiveness* 2-factor measurement model

---



---

Goodness of Fit Statistics
Degrees of Freedom = 33
Normal Theory Weighted Least Squares Chi-Square = 55.0743 (P = .009319)
Satorra-Bentler Scaled Chi-Square = 42.5779 (P = .1227)
Chi-Square Corrected for Non-Normality = 58.7389 (P = .003810)
Estimated Non-centrality Parameter (NCP) = 9.5779
90 Percent Confidence Interval for NCP = (.0 ; 30.5338)
Minimum Fit Function Value = .1035
Population Discrepancy Function Value (F0) = .07256
90 Percent Confidence Interval for F0 = (.0 ; .2313)
Root Mean Square Error of Approximation (RMSEA) = .04689
90 Percent Confidence Interval for RMSEA = (.0 ; .08372)
P-Value for Test of Close Fit (RMSEA < .05) = .5198
Expected Cross-Validation Index (ECVI) = .6559
90 Percent Confidence Interval for ECVI = (.5833 ; .8146)
ECVI for Saturated Model = .8333
ECVI for Independence Model = 10.7414
Chi-Square for Independence Model with 45 Degrees of Freedom = 1397.8615
Independence AIC = 1417.8615
Model AIC = 86.5779
Saturated AIC = 110.0000
Independence CAIC = 1456.7650
Model CAIC = 172.1656
Saturated CAIC = 323.9692
Normed Fit Index (NFI) = .9695
Non-Normed Fit Index (NNFI) = .9903
Parsimony Normed Fit Index (PNFI) = .7110
Comparative Fit Index (CFI) = .9929
Incremental Fit Index (IFI) = .9930
Relative Fit Index (RFI) = .9585
Critical N (CN) = 170.8157
Root Mean Square Residual (RMR) = .04597
Standardized RMR = .05091
Goodness of Fit Index (GFI) = .9907
Adjusted Goodness of Fit Index (AGFI) = .9845
Parsimony Goodness of Fit Index (PGFI) = .5944

---

## Competency F

The first-order *involves others and elicits participation* measurement model

---



---

 Goodness of Fit Statistics
 

---

Degrees of Freedom = 35  
 Minimum Fit Function Chi-Square = 45.7029 (P = .1064)  
 Normal Theory Weighted Least Squares Chi-Square = 43.9877 (P = .1418)  
 Satorra-Bentler Scaled Chi-Square = 39.3510 (P = .2813)  
 Chi-Square Corrected for Non-Normality = 76.4792 (P = .0001)  
 Estimated Non-centrality Parameter (NCP) = 4.3510  
 90 Percent Confidence Interval for NCP = (.0 ; 23.9701)  
 Minimum Fit Function Value = .3462  
 Population Discrepancy Function Value (F0) = .03296  
 90 Percent Confidence Interval for F0 = (.0 ; .1816)  
 Root Mean Square Error of Approximation (RMSEA) = .03069  
 90 Percent Confidence Interval for RMSEA = (.0 ; .07203)  
 P-Value for Test of Close Fit (RMSEA < .05) = .7351  
 Expected Cross-Validation Index (ECVI) = .6011  
 90 Percent Confidence Interval for ECVI = (.5682 ; .7498)  
 ECVI for Saturated Model = .8333  
 ECVI for Independence Model = 6.2224  
 Chi-Square for Independence Model with 45 Degrees of Freedom = 801.3584  
 Independence AIC = 821.3584  
 Model AIC = 79.3510  
 Saturated AIC = 110.0000  
 Independence CAIC = 860.2619  
 Model CAIC = 157.1580  
 Saturated CAIC = 323.9692  
 Normed Fit Index (NFI) = .9509  
 Non-Normed Fit Index (NNFI) = .9926  
 Parsimony Normed Fit Index (PNFI) = .7396  
 Comparative Fit Index (CFI) = .9942  
 Incremental Fit Index (IFI) = .9943  
 Relative Fit Index (RFI) = .9369  
 Critical N (CN) = 193.3513  
 Root Mean Square Residual (RMR) = .03222  
 Standardized RMR = .04969  
 Goodness of Fit Index (GFI) = .9375  
 Adjusted Goodness of Fit Index (AGFI) = .9018  
 Parsimony Goodness of Fit Index (PGFI) = .5966

---

## Competency G

The first-order single-factor *unites and connects followers* measurement model

---



---

Goodness of Fit Statistics
Degrees of Freedom = 35
Minimum Fit Function Chi-Square = 66.7075 (P = .0009768)
Normal Theory Weighted Least Squares Chi-Square = 75.1058 (P = .0001)
Satorra-Bentler Scaled Chi-Square = 59.2884 (P = .006337)
Chi-Square Corrected for Non-Normality = 68.5640 (P = .0005941)
Estimated Non-centrality Parameter (NCP) = 24.2884
90 Percent Confidence Interval for NCP = (6.8590 ; 49.5878)
Minimum Fit Function Value = .5054
Population Discrepancy Function Value (F0) = .1840
90 Percent Confidence Interval for F0 = (.05196 ; .3757)
Root Mean Square Error of Approximation (RMSEA) = .07251
90 Percent Confidence Interval for RMSEA = (.03853 ; .1036)
P-Value for Test of Close Fit (RMSEA < .05) = .1223
Expected Cross-Validation Index (ECVI) = .7522
90 Percent Confidence Interval for ECVI = (.6201 ; .9438)
ECVI for Saturated Model = .8333
ECVI for Independence Model = 7.9514
Chi-Square for Independence Model with 45 Degrees of Freedom = 1029.5796
Independence AIC = 1049.5796
Model AIC = 99.2884
Saturated AIC = 110.0000
Independence CAIC = 1088.4831
Model CAIC = 177.0953
Saturated CAIC = 323.9692
Normed Fit Index (NFI) = .9424
Non-Normed Fit Index (NNFI) = .9683
Parsimony Normed Fit Index (PNFI) = .7330
Comparative Fit Index (CFI) = .9753
Incremental Fit Index (IFI) = .9756
Relative Fit Index (RFI) = .9260
Critical N (CN) = 128.6678
Root Mean Square Residual (RMR) = .05573
Standardized RMR = .06416
Goodness of Fit Index (GFI) = .8978
Adjusted Goodness of Fit Index (AGFI) = .8394

---

## Competency G

The first-order two-factor *unites and connects followers* measurement model

---



---

Goodness of Fit Statistics

Degrees of Freedom = 34

Minimum Fit Function Chi-Square = 33.8594 (P = .4745)

Normal Theory Weighted Least Squares Chi-Square = 32.8618 (P = .5233)

Satorra-Bentler Scaled Chi-Square = 26.3354 (P = .8232)

Chi-Square Corrected for Non-Normality = 50.0269 (P = .03754)

Estimated Non-centrality Parameter (NCP) = .0

90 Percent Confidence Interval for NCP = (.0 ; 7.0679)

Minimum Fit Function Value = .2565

Population Discrepancy Function Value (F0) = .0

90 Percent Confidence Interval for F0 = (.0 ; .05355)

Root Mean Square Error of Approximation (RMSEA) = .0

90 Percent Confidence Interval for RMSEA = (.0 ; .03968)

P-Value for Test of Close Fit (RMSEA < .05) = .9781

Expected Cross-Validation Index (ECVI) = .5758

90 Percent Confidence Interval for ECVI = (.5758 ; .6293)

ECVI for Saturated Model = .8333

ECVI for Independence Model = 7.9514

Chi-Square for Independence Model with 45 Degrees of Freedom = 1029.5796

Independence AIC = 1049.5796

Model AIC = 68.3354

Saturated AIC = 110.0000

Independence CAIC = 1088.4831

Model CAIC = 150.0327

Saturated CAIC = 323.9692

Normed Fit Index (NFI) = .9744

Non-Normed Fit Index (NNFI) = 1.0103

Parsimony Normed Fit Index (PNFI) = .7362

Comparative Fit Index (CFI) = 1.0000

Incremental Fit Index (IFI) = 1.0077

Relative Fit Index (RFI) = .9661

Critical N (CN) = 281.9942

Root Mean Square Residual (RMR) = .03545

Standardized RMR = .04250

Goodness of Fit Index (GFI) = .9526

Adjusted Goodness of Fit Index (AGFI) = .9233

Parsimony Goodness of Fit Index (PGFI) = .5889

---

## Competency G

The second-order two-factor *unites and connects followers* measurement model

---

Goodness of Fit Statistics
Degrees of Freedom = 33
Normal Theory Weighted Least Squares Chi-Square = 25.7568 (P = .8114)
Satorra-Bentler Scaled Chi-Square = 20.4620 (P = .9567)
Chi-Square Corrected for Non-Normality = 40.2873 (P = .1790)
Estimated Non-centrality Parameter (NCP) = .0
90 Percent Confidence Interval for NCP = (.0 ; .0)
Minimum Fit Function Value = .07332
Population Discrepancy Function Value (F0) = .0
90 Percent Confidence Interval for F0 = (.0 ; .0)
Root Mean Square Error of Approximation (RMSEA) = .0
90 Percent Confidence Interval for RMSEA = (.0 ; .0)
P-Value for Test of Close Fit (RMSEA < .05) = .9968
Expected Cross-Validation Index (ECVI) = .5833
90 Percent Confidence Interval for ECVI = (.5833 ; .5833)
ECVI for Saturated Model = .8333
ECVI for Independence Model = 7.9514
Chi-Square for Independence Model with 45 Degrees of Freedom = 1029.5796
Independence AIC = 1049.5796
Model AIC = 64.4620
Saturated AIC = 110.0000
Independence CAIC = 1088.4831
Model CAIC = 150.0497
Saturated CAIC = 323.9692
Normed Fit Index (NFI) = .9801
Non-Normed Fit Index (NNFI) = 1.0174
Parsimony Normed Fit Index (PNFI) = .7188
Comparative Fit Index (CFI) = 1.0000
Incremental Fit Index (IFI) = 1.0126
Relative Fit Index (RFI) = .9729
Critical N (CN) = 354.3579
Root Mean Square Residual (RMR) = .03359
Standardized RMR = .04058
Goodness of Fit Index (GFI) = .9923
Adjusted Goodness of Fit Index (AGFI) = .9872
Parsimony Goodness of Fit Index (PGFI) = .5954

---

## Competency H

The first-order single-factor *strengthens and enables followers* measurement model

---



---

 Goodness of Fit Statistics
 

---

Degrees of Freedom = 35  
 Minimum Fit Function Chi-Square = 54.7787 (P = .01780)  
 Normal Theory Weighted Least Squares Chi-Square = 53.2341 (P = .02484)  
 Satorra-Bentler Scaled Chi-Square = 44.3796 (P = .1330)  
 Chi-Square Corrected for Non-Normality = 51.5422 (P = .03532)  
 Estimated Non-centrality Parameter (NCP) = 9.3796  
 90 Percent Confidence Interval for NCP = (.0 ; 30.5991)  
 Minimum Fit Function Value = .4150  
 Population Discrepancy Function Value (F0) = .07106  
 90 Percent Confidence Interval for F0 = (.0 ; .2318)  
 Root Mean Square Error of Approximation (RMSEA) = .04506  
 90 Percent Confidence Interval for RMSEA = (.0 ; .08138)  
 P-Value for Test of Close Fit (RMSEA < .05) = .5516  
 Expected Cross-Validation Index (ECVI) = .6392  
 90 Percent Confidence Interval for ECVI = (.5682 ; .8000)  
 ECVI for Saturated Model = .8333  
 ECVI for Independence Model = 11.0420  
 Chi-Square for Independence Model with 45 Degrees of Freedom = 1437.5483  
 Independence AIC = 1457.5483  
 Model AIC = 84.3796  
 Saturated AIC = 110.0000  
 Independence CAIC = 1496.4518  
 Model CAIC = 162.1866  
 Saturated CAIC = 323.9692  
 Normed Fit Index (NFI) = .9691  
 Non-Normed Fit Index (NNFI) = .9913  
 Parsimony Normed Fit Index (PNFI) = .7538  
 Comparative Fit Index (CFI) = .9933  
 Incremental Fit Index (IFI) = .9933  
 Relative Fit Index (RFI) = .9603  
 Critical N (CN) = 171.5559  
 Root Mean Square Residual (RMR) = .03818  
 Standardized RMR = .04414  
 Goodness of Fit Index (GFI) = .9254  
 Adjusted Goodness of Fit Index (AGFI) = .8827  
 Parsimony Goodness of Fit Index (PGFI) = .5889

---

## Competency I

The first-order single-factor *manages the internal work unit environment* measurement model

---



---

 Goodness of Fit Statistics
 

---

Degrees of Freedom = 35  
 Minimum Fit Function Chi-Square = 79.9033 (P = .0000)  
 Normal Theory Weighted Least Squares Chi-Square = 82.3577 (P = .0000)  
 Satorra-Bentler Scaled Chi-Square = 71.8031 (P = .0002433)  
 Chi-Square Corrected for Non-Normality = 102.2330 (P = .0000)  
 Estimated Non-centrality Parameter (NCP) = 36.8031  
 90 Percent Confidence Interval for NCP = (16.3518 ; 65.0197)  
 Minimum Fit Function Value = .6053  
 Population Discrepancy Function Value (F0) = .2788  
 90 Percent Confidence Interval for F0 = (.1239 ; .4926)  
 Root Mean Square Error of Approximation (RMSEA) = .08925  
 90 Percent Confidence Interval for RMSEA = (.05949 ; .1186)  
 P-Value for Test of Close Fit (RMSEA < .05) = .01791  
 Expected Cross-Validation Index (ECVI) = .8470  
 90 Percent Confidence Interval for ECVI = (.6921 ; 1.0608)  
 ECVI for Saturated Model = .8333  
 ECVI for Independence Model = 12.4906  
 Chi-Square for Independence Model with 45 Degrees of Freedom = 1628.7654  
 Independence AIC = 1648.7654  
 Model AIC = 111.8031  
 Saturated AIC = 110.0000  
 Independence CAIC = 1687.6689  
 Model CAIC = 189.6101  
 Saturated CAIC = 323.9692  
 Normed Fit Index (NFI) = .9559  
 Non-Normed Fit Index (NNFI) = .9701  
 Parsimony Normed Fit Index (PNFI) = .7435  
 Comparative Fit Index (CFI) = .9768  
 Incremental Fit Index (IFI) = .9769  
 Relative Fit Index (RFI) = .9433  
 Critical N (CN) = 106.4162  
 Root Mean Square Residual (RMR) = .03843  
 Standardized RMR = .05200  
 Goodness of Fit Index (GFI) = .8891  
 Adjusted Goodness of Fit Index (AGFI) = .8257  
 Parsimony Goodness of Fit Index (PGFI) = .5658

---

## Competency I

The first-order two-factor *manages the internal work unit environment* measurement model

---



---

 Goodness of Fit Statistics
 

---

Degrees of Freedom = 34

Minimum Fit Function Chi-Square = 49.5918 (P = .04102)

Normal Theory Weighted Least Squares Chi-Square = 46.2316 (P = .07866)

Satorra-Bentler Scaled Chi-Square = 40.3939 (P = .2086)

Chi-Square Corrected for Non-Normality = 74.0124 (P = .0001)

Estimated Non-centrality Parameter (NCP) = 6.3939

90 Percent Confidence Interval for NCP = (.0 ; 26.5099)

Minimum Fit Function Value = .3757

Population Discrepancy Function Value (F0) = .04844

90 Percent Confidence Interval for F0 = (.0 ; .2008)

Root Mean Square Error of Approximation (RMSEA) = .03774

90 Percent Confidence Interval for RMSEA = (.0 ; .07686)

P-Value for Test of Close Fit (RMSEA &lt; .05) = .6533

Expected Cross-Validation Index (ECVI) = .6242

90 Percent Confidence Interval for ECVI = (.5758 ; .7766)

ECVI for Saturated Model = .8333

ECVI for Independence Model = 12.4906

Chi-Square for Independence Model with 45 Degrees of Freedom = 1628.7654

Independence AIC = 1648.7654

Model AIC = 82.3939

Saturated AIC = 110.0000

Independence CAIC = 1687.6689

Model CAIC = 164.0912

Saturated CAIC = 323.9692

Normed Fit Index (NFI) = .9752

Non-Normed Fit Index (NNFI) = .9947

Parsimony Normed Fit Index (PNFI) = .7368

Comparative Fit Index (CFI) = .9960

Incremental Fit Index (IFI) = .9960

Relative Fit Index (RFI) = .9672

Critical N (CN) = 184.1983

Root Mean Square Residual (RMR) = .02881

Standardized RMR = .03950

Goodness of Fit Index (GFI) = .9345

Adjusted Goodness of Fit Index (AGFI) = .8941

Parsimony Goodness of Fit Index (PGFI) = .577



## Competency I

The second-order two-factor *manages the internal work unit environment* measurement model

---



---

 Goodness of Fit Statistics
 

---

Degrees of Freedom = 33

Normal Theory Weighted Least Squares Chi-Square = 45.9230 (P = .06677)

Satorra-Bentler Scaled Chi-Square = 40.7159 (P = .1672)

Chi-Square Corrected for Non-Normality = 71.9597 (P = .0001021)

Estimated Non-centrality Parameter (NCP) = 7.7159

90 Percent Confidence Interval for NCP = (.0 ; 28.0866)

Minimum Fit Function Value = .06296

Population Discrepancy Function Value (F0) = .05845

90 Percent Confidence Interval for F0 = (.0 ; .2128)

Root Mean Square Error of Approximation (RMSEA) = .04209

90 Percent Confidence Interval for RMSEA = (.0 ; .08030)

P-Value for Test of Close Fit (RMSEA &lt; .05) = .5922

Expected Cross-Validation Index (ECVI) = .6418

90 Percent Confidence Interval for ECVI = (.5833 ; .7961)

ECVI for Saturated Model = .8333

ECVI for Independence Model = 12.4906

Chi-Square for Independence Model with 45 Degrees of Freedom = 1628.7654

Independence AIC = 1648.7654

Model AIC = 84.7159

Saturated AIC = 110.0000

Independence CAIC = 1687.6689

Model CAIC = 170.3035

Saturated CAIC = 323.9692

Normed Fit Index (NFI) = .9750

Non-Normed Fit Index (NNFI) = .9934

Parsimony Normed Fit Index (PNFI) = .7150

Comparative Fit Index (CFI) = .9951

Incremental Fit Index (IFI) = .9952

Relative Fit Index (RFI) = .9659

Critical N (CN) = 178.5820

Root Mean Square Residual (RMR) = .02818

Standardized RMR = .03856

Goodness of Fit Index (GFI) = .9949

Adjusted Goodness of Fit Index (AGFI) = .9914

Parsimony Goodness of Fit Index (PGFI) = .5969
 

---