

# Modelling Drug Abuse and Drug-related Crime: A Systems Approach

by  
Lezanie Coetzee



Thesis presented in partial fulfilment of the  
academic requirements for the degree of  
Master of Science  
at the University of Stellenbosch

Supervisor: Prof. Farai Nyabadza  
(University of Stellenbosch)

December 2015

## Declaration

By submitting this thesis/dissertation electronically, I declare that the entirety of the work contained therein is my own, original work, that I am the sole author thereof (save to the extent explicitly otherwise stated), that reproduction and publication thereof by Stellenbosch University will not infringe any third party rights and that I have not previously in its entirety or in part submitted it for obtaining any qualification.

December 2015

Copyright © 2011 Stellenbosch University  
All rights reserved.

## Abstract

In this study we look at the syndemic of substance abuse and drug-related crime in the Western Cape province of South Africa. The intent of this study is to provoke critical thinking about the possibilities systems thinking and system dynamics poses for social and health challenges in a diverse and complex environment like that of South Africa, especially the Western Cape. This study ventures into cross-discipline work between Epidemiology, Biomathematics and System Dynamics, with the hope of encouraging researchers from different fields to collaborate in order to curb the scourge of substance abuse and drug-related crime in South Africa. Substance abuse and the associated health and social hazards such as drug-related crime is a major problem in the Western Cape. Drug-related crime cases reported by the South African Police Services (SAPS) for the Western Cape exhibited a 311.5% growth in the past decade. This highlights how the reduction of substance abuse and drug-related crime within the Western Cape province, will be an elixir for the safety and development of the communities. The fight against substance abuse has been driven by a multi-sectorial approach involving several government departments, non-governmental organisations and communities. With systems thinking the assumption is that the world is systemic, which means that phenomena is understood to be an emergent property of the interrelated whole. Firstly, using non-linear ordinary differential equations, we formulate a deterministic mathematical model for the substance abuse and drug-related crime syndemic, evaluate the threshold number and use sensitivity analysis to analyze the model. Secondly, a dynamic system, called the Substance Abuse and Drug-related Crime in the Western Cape (SADC-WC) system is constructed using the STELLA in order to explore and classify the underlying relationships and structures within the substance abuse and drug-related crime system. Both the sensitivity analysis, and the simulations of the SADC-WC system indicate that an increase of successful convictions will have a significant influence on the syndemic, and promise to reduce drug-related crime cases.

## Opsomming

In hierdie studie ondersoek on die syndemie ('syndemic') van dwelmmisbruik en dwelm-  
verwante misdaad in die Wes-Kaap provinsie, in Suid-Afrika. Die moontlikhede wat  
sistemiese denke en dinamiese sisteme inhou vir sosiale en gesondheid kwale in 'n di-  
verse en komplekse omgewing soos Suid-Afrika, word ondersoek. Hierdie studie waag  
interdisiplinêre werk tussen Epidemiologie, Biowiskunde en Dinamiese sisteme, met  
die hoop om navorsers van verskillende velde aan te moedig om saam te werk om  
die plaag van dwelmmisbruik en dwelm-verwante misdaad in Suid-Afrika te bekamp.  
Dwelmmisbruik en die gepaardgaande gesondheid en maatskaplike gevare soos dwelm-  
verwante misdaad is 'n groot probleem in die Wes-Kaap. Die SAPD se vermelde dwelm-  
verwante misdaad het 'n groei van 311,5% ondergaan in die afgelope dekade, en is aan-  
duidend vir hoe die beheer en beperking van dwelmmisbruik en dwelm-verwante mis-  
daad in die Wes-Kaap provinsie bevordering van beide die veiligheid en ontwikkeling  
van die gemeenskap sal verseker. Dit beklemtoon hoe die vermindering van dwelmmis-  
bruik en dwelm-verwante misdaad in die Wes-Kaapland, sal 'n elikser vir die veiligheid  
en ontwikkeling van die gemeenskappe. Die stryd teen dwelmmisbruik is gedryf deur  
'n multi-sektorale benadering waarby verskeie regeringsdepartemente, nie-regerings  
organisasies en gemeenskappe. Stelsels denke en dinamiese sisteme is gebaseer op die  
aanname, dat die wêreld is sistemiese en dat verskynsels verstaan word ten opsigte  
van die ontlukende eienskap van die omvattende geheel. Eerstens stel ons 'n komparte-  
mentele model op wat deur nie-liniêre gewone differensiële vergelykings beskryf kan  
word vir die dwelmmisbruik en dwelm-verwante misdaad epidemies. Ons evalueer  
die drumpel getal en gebruik sensitiviteitsanalise om die parameters van die model te  
analiseer. Tweedens, is 'n dinamiese sisteem genaamd die Middelmisbruik en dwelm-  
verwante misdaad in die Wes-Kaap (SADC-WC) stelsel gebou met behulp van die STELLA  
platform om te verken en klassifiseer die onderliggende verhoudings en strukture binne  
die dwelmmisbruik en dwelm-verwante misdaad stelsel. Beide die sensitiviteitsanalise,  
en die simulaties van die SADC-WC stelsel dui aan dat 'n toename in suksesvolle  
vonisse 'n beduidende invloed op die epidemies sal hê; en beloop om sake van dwelm-  
verwante misdaad te verminder.

# Dedications

*For my Lord and Saviour, thank you for Your Grace. For when I am weak, I am strong.  
2 Corinthians 12:10*

# Acknowledgements

I would like to extend my sincere appreciation to my academic supervisor Prof. Farai Nyabadza. I am honoured to know you, and to work with you. Thank you for always keeping your office door open. Your wisdom will be cherished, and your kindness and capacity to care will inspire me for many years to come. My colleague and dear friend John Boscoh Hatson Njagarah, thank you for all the insightful discussions on work and life. May you keep on extending your hand to those in need.

My loving family, especially my parents Diek and Zelia Coetzee, thank you for always standing rock solid behind me. I love you so much. To my friends that is always on the frontier of life with me, thank you for always standing next to me.

Finally, I want to acknowledge and honour Our Father in heaven. By Your grace we shall not cease from exploration.

# Contents

<b>Opsomming</b>	<b>ii</b>
<b>1 Introduction</b>	<b>1</b>
1.1 Problem and motivation . . . . .	1
1.2 Aims and objectives . . . . .	7
1.3 Project outline . . . . .	8
<b>2 Literature review</b>	<b>10</b>
2.1 Substance abuse and drug-related crime in the Western Cape . . . . .	10
2.2 From a systems perspective . . . . .	14
2.2.1 Systems thinking . . . . .	14
2.2.2 System dynamics . . . . .	16
2.2.3 STELLA . . . . .	18
2.3 Models of substance abuse and drug-related crime . . . . .	19
<b>3 Deterministic model for the substance abuse and drug-related crime syndemic</b>	<b>24</b>
3.1 Introduction . . . . .	24
3.1.1 Model formulation . . . . .	25

---

3.1.2	Basic properties of the syndemic model . . . . .	27
3.2	Model analysis . . . . .	30
3.2.1	The drug-free equilibrium and the basic reproduction number . . . . .	30
3.2.2	Global stability of the drug-free steady state . . . . .	31
3.2.3	The drug persistent equilibrium . . . . .	33
3.3	Sensitivity analysis . . . . .	37
3.3.1	Parameter estimation . . . . .	38
3.3.2	Results of our analysis . . . . .	39
<b>4</b>	<b>A system dynamics model</b>	<b>43</b>
4.1	Model building . . . . .	43
4.1.1	Model boundaries . . . . .	44
4.1.2	Stocks and flows . . . . .	45
4.1.3	Sources of information for the flows . . . . .	45
4.2	Model analysis . . . . .	48
4.2.1	Casual loop diagram . . . . .	48
4.2.2	Main feedback loops . . . . .	48
4.2.3	Model diagram . . . . .	50
4.3	Simulation of the model . . . . .	52
4.3.1	Equations that determine the flows . . . . .	52
4.3.2	Initial conditions and parameter estimation . . . . .	53
4.3.3	Results . . . . .	56



Contents	vii
<b>5 Discussion and conclusion</b>	<b>66</b>
<b>Appendix</b>	<b>70</b>
<b>A STELLA equations</b>	<b>70</b>
A.1 Equations for the SADC-WC system model for 2004 – 2014 . . . . .	70
A.2 Equations for the SADC-WC system model for 2004 – 2024 . . . . .	72
A.3 Equations for the SADC-WC system model for 2004 – 2024 with inter- vention 1 . . . . .	74
A.4 Equations for the SADC-WC system model for 2004 – 2024 with inter- vention 2 . . . . .	76
A.5 Equations for the SADC-WC system model for 2004 – 2024 with inter- vention 3 . . . . .	78

# List of Figures

1.1	Drug-related crimes recorded nationally in 2014 by the South African Police Services (SAPS),the more intense the colour the higher the drug-related crime level [3, 32]. . . . .	2
1.2	Drug-related crimes and total crimes of 2014 recorded in the Western Cape by the South African Police Services (SAPS) [3] . . . . .	3
1.3	The top ten precincts of drug-related of 2014 recorded in the South Africa by the South African Police Services (SAPS) [3] . . . . .	3
1.4	The application of System Dynamics [42]. . . . .	5
1.5	An illustration of a simple conceptual model for drug abuse from a systems perspective. Where DAP = Drug associated problems, PR = Perceived risks, DSP = Drug supply and price and NB = Norms and beliefs. . . . .	7
2.1	Drug-related crime in the Western Cape [64]. . . . .	12
2.2	Crime maps of South Africa showing police precincts with drug-related crime levels, the more intense the colour the higher the crime level. The escalation of drug-related crime in the past decade is evident from the images, with the crime concentrated in the Western Cape province for the year 2005 and 2014 respectively [32] . . . . .	13
2.3	Basic modelling icons in STELLA used as building blocks for a system. . . . .	19

3.1	A compartmental representation for the model of the syndemic of substance abuse and drug-related crime. . . . .	26
3.2	PRCCs for the parameters of interest with respect to $\mathcal{R}_0$ from Table 3.2 . . . . .	40
3.3	Cases (a), (b), (c), (d) and (e) show the Monte Carlo simulations for the five parameters influencing $\mathcal{R}_0$ , namely $\sigma, \rho_1, \gamma_2, \alpha_2$ and $\rho_2$ . Case (f) is a box plot depicting the different values for $\mathcal{R}_0$ according to the varying variables. . . . .	41
4.1	Progress and finalisation of cases. The main outcomes of crimes as indicated by the point in the criminal justice system where it is pending or closed. (SAPS classification system) [10] . . . . .	47
4.2	Causal loop diagram for the SADC-WC system. . . . .	49
4.3	Map of the SADC-WC system in STELLA without any converters. . . . .	50
4.4	Map of the SADC-WC system in STELLA with converters. . . . .	51
4.5	The stocks of the SADC-WC system for 2004 – 2014. . . . .	56
4.6	The flows of the SADC-WC system for 2004 – 2014. . . . .	57
4.7	The SADC-WC system for 2004 – 2014 and comparable data for the period [20, 3]. . . . .	58
4.8	Projected stocks and flows for the SADC-WC system for 2004 – 2024. . . . .	60
4.9	Projected stocks and flows for the SADC-WC system with increased convictions, intervention 1, for 2004 – 2024. . . . .	61
4.10	Projected stocks and flows for the SADC-WC system with with incresed correc-tional service referrals to rehabilitation centres, intervention 2, for 2004 – 2024. . . . .	63
4.11	Projected stocks and flows for the SADC-WC system with reduced relapse into substance abuse, intervention 3, for 2004 – 2024. . . . .	64

# List of Tables

3.1	Description of parameters used in the model. . . . .	26
3.2	Parameter values used in sensitivity analysis. . . . .	39
4.1	Stocks and Flows of the SADC-WC system, where the cloud symbol (☁) refers to a source/pit in the system. . . . .	46
4.2	Converters and equations for the SADC-WC system, the parameters descriptions and values are given in Table 4.4 . . . . .	52
4.3	Initial values for the SADC-WC system. . . . .	53
4.4	Parameters for the SADC-WC system. . . . .	55

# Chapter 1

## Introduction

### 1.1 Problem and motivation

Substance abuse pervades globally in spite of ceaseless warnings and evidence based research highlighting the associated social and health hazards, such as morbidity, mortality and hefty budgetary constraints [23]. Substance abuse is a national menace in South Africa, especially in the Western Cape [3, 44, 64]. Measuring drug use in a population is difficult, given the illicit nature of the substances and the social stigma attached to drug use. The South African Community Epidemiology Network on Drug Use (SACENDU) has conducted studies on drug use and trends across the country since 1996, including in the Western Cape. In an update report that SACENDU published at the end of 2014 [20], they showed that 23% – 41% of individuals in rehabilitation centres in South Africa are under the age of 20. These percentages illustrate the immense influence drug abuse has on communities, families, youth and education in South Africa, and the indirect damage drug abuse holds in for the future of the country.

South Africa's geographic location, lax border controls, weak criminal justice system, modern telecommunications, banking systems and international trade links with South America, North America, Asia and Europe endanger the country to transshipment of drugs [52]. Substance abuse and its associated social challenges such as drug-related crime is a national menace in South Africa, as illustrated in Figure 1.1, showing police precincts with their respective drug-related crime levels for 2014. The Institute for Se-

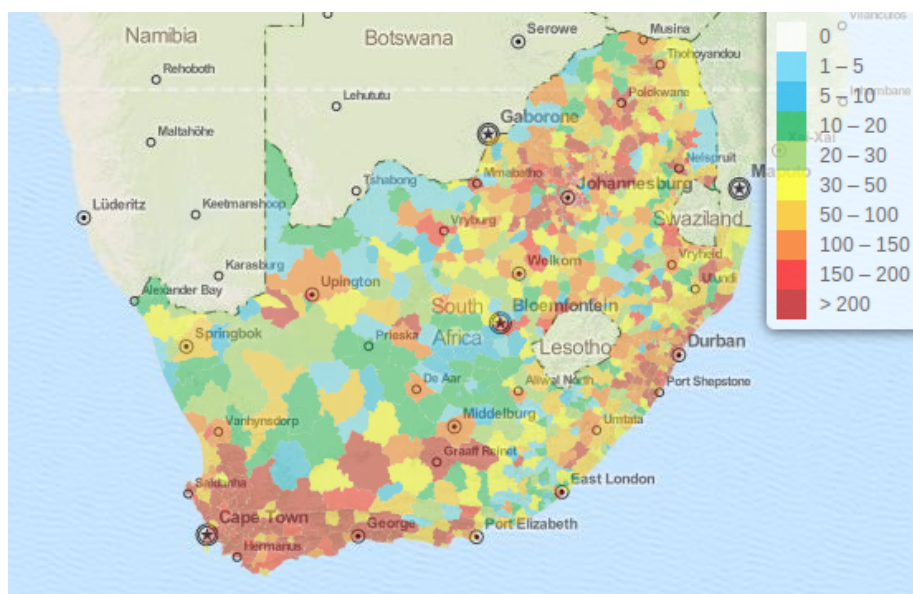

Figure 1.1. Drug-related crimes recorded nationally in 2014 by the South African Police Services (SAPS), the more intense the colour the higher the drug-related crime level [3, 32].

curity Studies' (ISS) [32] crime map, clearly illustrates the current drug-related crime epidemic in South Africa, and highlights how it is concentrated in the Western Cape [3, 44, 64]. The market for drugs in the Western Cape is diversified and large as explained by Khalil Goga [38]. The market is sustained through the supply and demand of a sizeable number of people involved at various levels of the system, from independent dealers to large-scale traffickers transporting hard drugs by the ton. Consequently, substance abuse does not only blight the health of individual lives, but also undermines the social structures of families and damages whole communities within the Western Cape with its associated health and social hazards [43, 59].

Current crime statistics for South Africa ought to evoke great concern [69], specifically with reference to drug-related crime, which have shown enormous growth in the past decade with respect to the total crime in the Western Cape, as illustrated in Figure 1.2. According to the Department of Community Safety more than a third, (35%), of the crime in the Western Cape is caused by substance abuse (drugs and alcohol), explaining the high contribution the Western Cape had in the national drug related crime in the past decade (consistently higher than 30%). The 2013/2014 report on the Western Cape policing needs and priorities (PNP Report) announced substance abuse as one of the main factors motivating people to commit crime at 22% [44]. Of the total of 258472

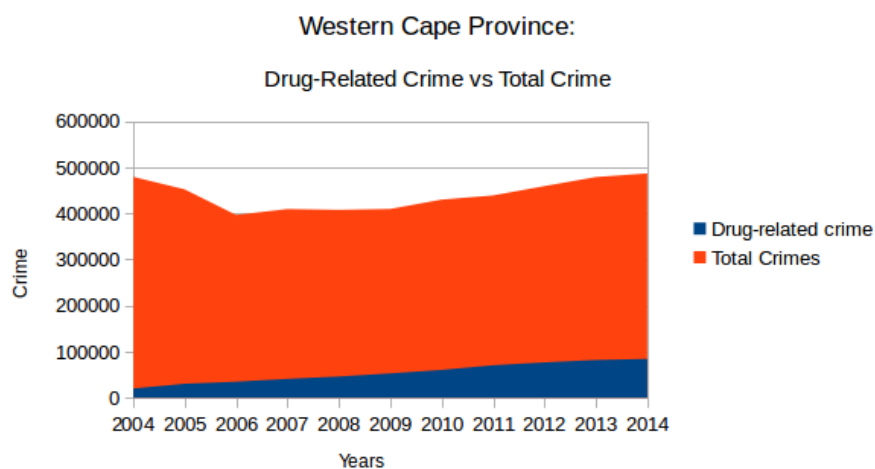

Figure 1.2. Drug-related crimes and total crimes of 2014 recorded in the Western Cape by the South African Police Services (SAPS) [3]

drug-related crime cases opened nationally in 2014, 84337 were in the Western Cape, with Mitchells Plain being the worst by a large margin, as seen in Figure 1.3 depicting the top ten precincts of drug-related crime in South Africa with six of the ten being in the Western Cape.

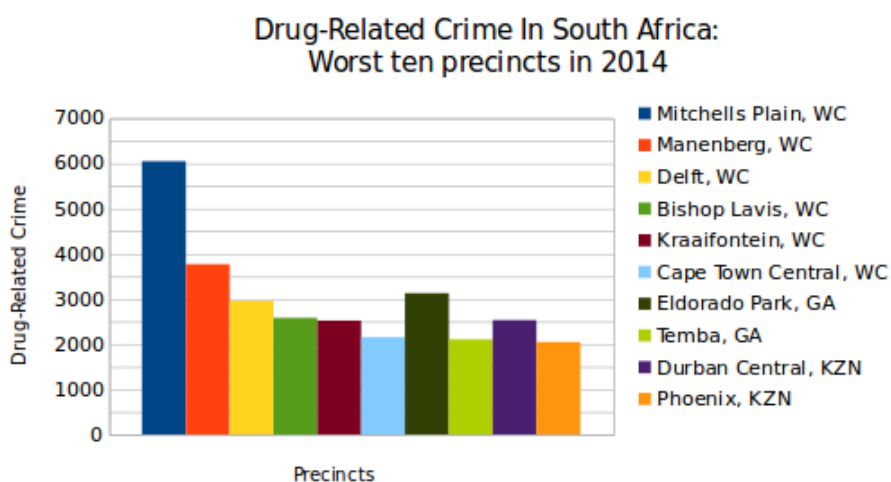

Figure 1.3. The top ten precincts of drug-related of 2014 recorded in the South Africa by the South African Police Services (SAPS) [3]

The complexity of problems that occur due to substance abuse demand researchers in the social sciences to turn to scientific fields such as biology, epidemiology, mathemat-

ics and systems dynamics to view substance abuse within the greater system where it is embedded. Substance abuse is one of the complex challenges that researchers in different fields are battling to understand and analyze, specifically with regards to the ripple effects of drug-related crime within communities and the spread of sexual transmitted infections. Systems thinking and system dynamics expand the horizon for cross-discipline research, enabling the social sciences and natural sciences to integrate descriptive and quantitative research and collaborate in order to inform communities and assist stake holders and policy makers at the same time. Systems thinking does not find its foundation in one single discipline, but it rather builds on the linkage of disciplines, it considers connections among different actors, through trans-disciplinary thinking and active engagement of those who are influenced by the outcomes to govern the change [54, 60, 61]. Systems thinking encourages collaboration, multidisciplinary, interdisciplinary and translational research [56, 61], and holds great potential for improving the efficiency and validity of research. Systems thinking addresses complex problems researchers face every day, by generating recommendation and solutions that are relevant and translatable for policy makers [56, 61].

Substance abuse and drug-related crime have causes and conditions that go far beyond the biology and behaviour of the individual human being. Whilst studying drug abuse drug-related crime, systems thinking allows one to consider the following systems at once: biological systems, organizational systems, political systems etc [60, 61]. Systems thinking and systems models equips one to define the complex interactions that substance abuse and drug-related crime cause on community and governmental levels. It provides an innovative way to approach and analyze the complex and adaptive system of drug using communities, rehabilitation centres law enforcement, correctional services and the government. The evolution of substance abuse within communities has been likened to that of infectious diseases through mathematical models [22, 23, 24, 43, 59], suggesting that the dynamics of substance abuse is similar to that of infectious diseases where initiation into drug use is based on contact of those at risk with drug users. Most causations of diseases are non-linear, dynamic and multi-factorial [61]; the same is expected for the syndemic of substance abuse and drug-related crime and even more complex. Systems allow researchers to reflect on the functional areas of the disease itself, together with the burden it has on its environment, resulting in a sum greater than the individual contributions.



The adaptive complexities we see in systems are often caused by the countervailing forces that undermine the interventions that focus on changing societal structures [61]. By examining and modelling the behaviour of actions and their consequences (intended and unintended), systems methods facilitate a constructive way of working with complex adaptive systems. Studying a community as an interacting set of systems that support or buffer the incidence of specific substance misuse outcomes such as drug-related crime, allows one to: (1) develop system models that will capture the primary community structures and relationships that support problems such as substance abuse and related outcomes, and (2) testing control strategies that can potentially moderate or reduce the problems [26]. In Figure 1.4 the these applications of System Dynamics are illustrated.

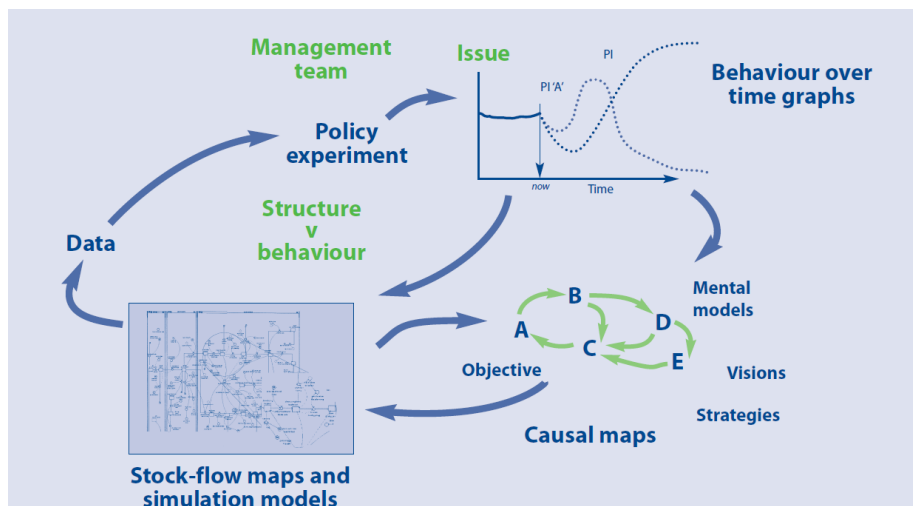

Figure 1.4. The application of System Dynamics [42].

Drug abuse is a serious public health problem in South Africa, Swanson et al [54] argue that “Public health challenges and risk factors, including chronic diseases, infectious diseases, mental health problems, obesity, imbalanced nutrition, smoking and alcohol and substance abuse, emerge from a complex system of spatial temporal interactions at the biological, socio-behavioural and economic scales”. The principles of systems thinking are relevant and purposive with respect to sustainable and effective change for public health [17, 54, 56]. From a public health perspective the National Department of Health indicated that the South African health system is hospi-centric and specialized, where service rather than population needs drives decision-making [46]. For a conscientious inquiry of population needs, a holistic view of substance abuse and drug-related

crime is required, where drug users, rehabilitation centres, communities, police enforcement and the judiciary are considered as interacting entities or systems. The dynamic nature of these systems demand thinking in systems in order to expand and challenge the current deterministic models for substance abuse, as well as the trend to look at substance abuse in isolation. Systems thinking and systems models create a platform to not only take account of the challenges substance abuse present at different societal levels, but also how these different levels interact and react as a whole. In systems science the presumption is, that the only way to fully understand why a problem occurs and persists is to understand the parts in relation to the whole [21]. With the focus on substance abuse and drug-related crime, the goal is to unravel why substance abuse and drug-related crimes persist to escalate and how this enigma stands in relation to the law enforcement, correctional services and rehabilitation centres.

Several government departments, communities and non-governmental organisations have been put in place in the Western Cape to deal with substance abuse and its related problems, these systems are interconnected and linked. Motivated by [30, 71], we propose the Drug users, Policing, Judicial, Community and Rehabilitation (DPJCR) system as an conceptual model for this study. Substance abuse and crime revolve around drug users, policing, the judicial system, communities and rehabilitation. We expect that the DPJCR system, as in the case with most other health and social systems, to exhibit the following characteristics: self-organizing, constantly changing, tightly-linked, governed by feedback, non-linear, history dependant, counter-intuitive and resistant to change [2]. A comprehensive systems perspective is suggested to guide research and policy with regards to drug abuse and drug-related crime. Collaboration across disciplines, sectors and organizations are thus paramount.

In this study we suggest that systems thinking and systems models are relevant and opportune for the challenges we are facing both globally and locally with regards to substance abuse and the immeasurable consequences it has to public health, quality of community lives, the local economy and crime. Figure 1.5 illustrates how the actors/-components in the DPJCR system are an integrated and interacting entity that evolves over time. This is a basic conceptual model that explores the networks and components involved in the fight against drug abuse and drug-related crime. The model can be improved depending on the intended objectives of the research. Such models can be fitted to data to better convey the complexity of drug abuse within our communities and to

identify points in the system where interventions are likely to yield the greatest impact.

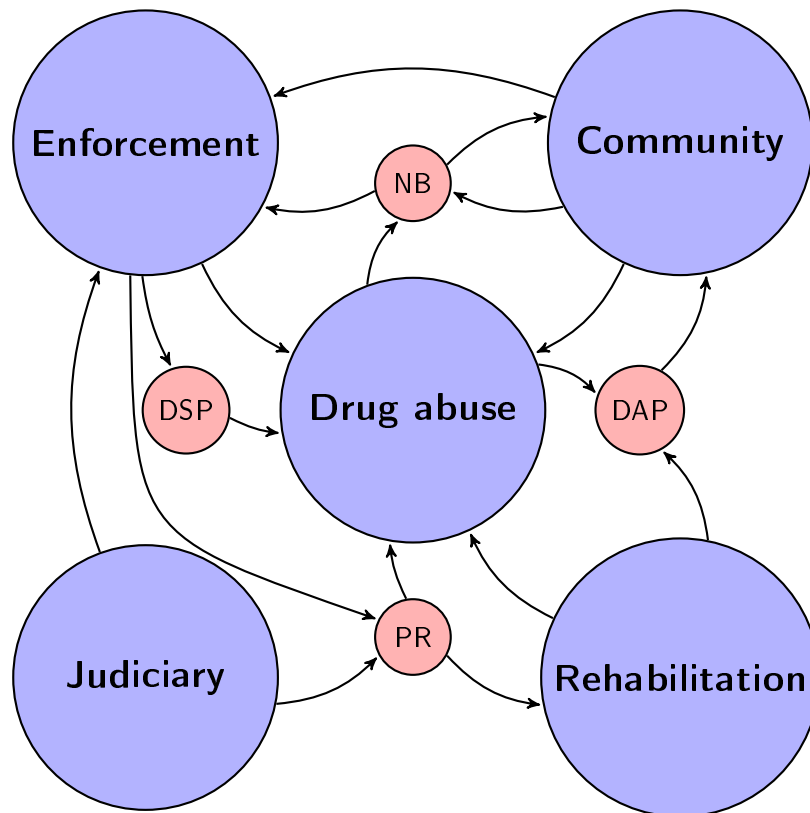

Figure 1.5. An illustration of a simple conceptual model for drug abuse from a systems perspective. Where DAP = Drug associated problems, PR = Perceived risks, DSP = Drug supply and price and NB = Norms and beliefs.

## 1.2 Aims and objectives

The aim of this study is to investigate the relationship between substance abuse and drug-related crime within the Western Cape. The study is premised on the assumption that social and health problems such as drug-related crime and substance abuse are heterogeneously distributed with respect to population and geography, and are thus fundamentally local problems.

Three specific prospects will be addressed with this study:

- An overview of the syndemic of substance abuse and drug-related crime in the

Western Cape.

- The concoction of two diverse but complimentary models that capture the primary community structures and relationships that support the syndemic of substance abuse and drug-related crime in the Western Cape.
- Rationally explore and test control strategies/interventions that have the potential to moderate or restrain the occurrence of the syndemic in the Western Cape.

To meet the above objectives we do a thorough literature review on drug abuse and drug-related crime, general and mathematical models that have been developed to devise substance abuse and/or drug-related crime and finally do a short overview of systems thinking and systems dynamics. Firstly, using non-linear ordinary differential equations, we formulate a deterministic mathematical model for the substance abuse and drug-related crime syndemic, evaluate the threshold number and use sensitivity analysis to analyze the model. Secondly, a dynamic system will be constructed with the STELLA platform in order to explore and classify the underlying relationships and structures within the substance abuse and drug-related crime system. By using data from both governmental and private projects, simulation of the system will be produced, revised and discussed. The models are linked to data from the South African Community Epidemiology Network on Drug Use (SACENDU), Crime Statistics South Africa (Crime Stats SA), Census South Africa and South Africa health (SA health) info to carry out the simulations. Data used and calculations done are found in the Appendix at the end of the study.

### 1.3 Project outline

In this study we explore the current state of drug abuse and it's relation to drug-related crime within the Western Cape province of South Africa from a systems thinking and systems dynamic approach. A thorough literature review is presented in Chapter 2 with the focus on three primary areas: Firstly an overview of the substance abuse and drug-related crime syndemic in the Western Cape, secondly considering various authors' mathematical models and general models on substance abuse. Thirdly a review of systems thinking, systems dynamics and STELLA are conferred. The conceptual model in

Figure 1.5 illustrates the composition of concepts which are used to investigate the syndemic of substance abuse and drug-related crime in the Western Cape province in this study. The syndemic is investigated from two different perspectives. Firstly, in Chapter 3 a deterministic model for the substance abuse and drug-related crime syndemic is developed to determine and investigate the reproduction number  $\mathcal{R}_0$  of the model, and to do a sensitivity analysis of the parameters used in the model that influences the threshold number. Secondly, in Chapter 4 a conceptual model is assembled based on the DPJCR theoretical model. More specifically, the local community is viewed as an interacting set of dynamic systems that support the occurrence of substance abuse and drug-related crime. The conceptual model is used as the foundation for a systems dynamic model constructed in Chapter 4 in order to expand and challenge the restrictions encountered in Chapter 3. The intention of the study is to traverse the substance abuse and drug-related crime syndemic in a deterministic model and systems dynamic model respectively. With the intention on gaining a better understanding of the underlining structure of the system that sustain drug abuse and drug-related crimes within the communities, as well as exploring the relationship between law-enforcement, correctional services and rehabilitation centres within the system. Finally the models are fitted to data to better convey the complexity of drug abuse and drug-related crime within the Western Cape communities and focus on identifying areas in the system where interventions are likely to yield the greatest impact. Chapter 5 is a reflection on the models presented in Chapter 3 and Chapter 4, discussing the challenges, short comings and advantages of the models. Finally, a few ideas are proposed for the way forward in the conclusion of the study.

# Chapter 2

## Literature review

### 2.1 Substance abuse and drug-related crime in the Western Cape

Chief specialist of the alcohol and drug abuse unit at the South African Medical Research Council (MRC), Bronwyn Meyers [1], announced that 11% (5.7 million people) of the South African population will suffer from an addiction disorder in their lifespan. In 2012, Dr David Bayever from the government drug control organisation (CDA) was quoted saying that at least 15% of South Africans have a substance abuse problem and that the number is expected to grow, adding that “While some drugs are produced directly in South Africa, it is also a major trans-shipment hub for importing and exporting them.” [1]. Ramlagan et al. [57] recorded different notions for using substances in their work: “... poverty, unemployment, lack of recreational facilities, being surrounded by substance abusers, long shifts at work, high stress as a result of a combination of unemployment and family problems, boredom and work pressures were also mentioned as factors contributing to substance abuse.”

The South African Community Epidemiology Network on Drug Use (SACENDU) project is a surveillance system supported by a network of researchers, practitioners and policy makers from various sentinel areas in South Africa. The project has been operational since 1996, collecting and analysing alcohol and other drug (AOD) use data from 64

rehabilitation centres in all 9 provinces of South Africa [20]. Alcohol and Cannabis remains the two substances that the majority of users admitted to rehabilitation centres list as their primary and secondary drugs across South Africa; with alcohol as primary drug ranging from 16% – 43% and cannabis as primary drug from 20% – 50% [63]. In an update report that SACENDU published at the end of 2014 [63], they showed that 23% – 41% of individuals in rehabilitation centres in South Africa are under the age of 20. These percentages illustrate the immense influence drug abuse has on communities, families, youth and education in South Africa, and the indirect damage drug abuse holds in for the future of the country.

The primary substance use trends vary by region, and in the Western Cape province the majority of treatment is for methamphetamine (locally referred to as 'tik') and cannabis [43, 63]. SACENDU recorded that 75% of the patients admitted to rehabilitation are male, and 71% of the patients are Coloured followed by 15% African/Black patients [18]. Available data from SACENDU indicate 70% of the patients are single and 18% of the patients are married. Just over half of the patients, specifically 55% are unemployed and 20% are students and learners while only 19% working full time. Three quarters of the patients have completed secondary education (grade 8 – 12), 14% have primary education and 8% have tertiary education. The age range of the patients are from 10 – 72 years, where 42% of patients in treatment are under the age of 25 [18]. The distribution of in patient and out patient was 33 – 39% and 61 – 67% respectively for the Western Cape in 2013 [18]. Which is significantly different in comparison to that which was observed in 2004, where 66 – 68% were in patient and 32 – 34% were out patient [62]. Ramlagan et al. found higher drop-out rates at out-patient-based facilities compared with in-patient-based facilities, since abusers ought to have a greater prospect of being influenced before their treatment is completed [57].

Seeker and Thalar [39] noted in their study on violence and socio-economic conditions in Cape Town that, South Africa exhibits controversial data, where crime has increased rather than decline since democratization in 1994. Direct poverty, living in a bad neighbourhood and substance abuse correlated more with violence against strangers than the expected culprits unemployment and poverty [39]. In the 3-Metros Study of Drugs and Crime in South Africa: Findings and Policy Implications, 45% of arrestees tested positive for at least one drug, and that drug positive arrestees were more likely to have had a

prior arrest [51]. Figure 2.1 shows a significant increase of 311.5% for drug-related crime since the 2003/2004 annual report of the SAPS [65]. The unique gang culture found on the 'Cape Flats' within the Western Cape is strongly associated with drug trade [6, 43].

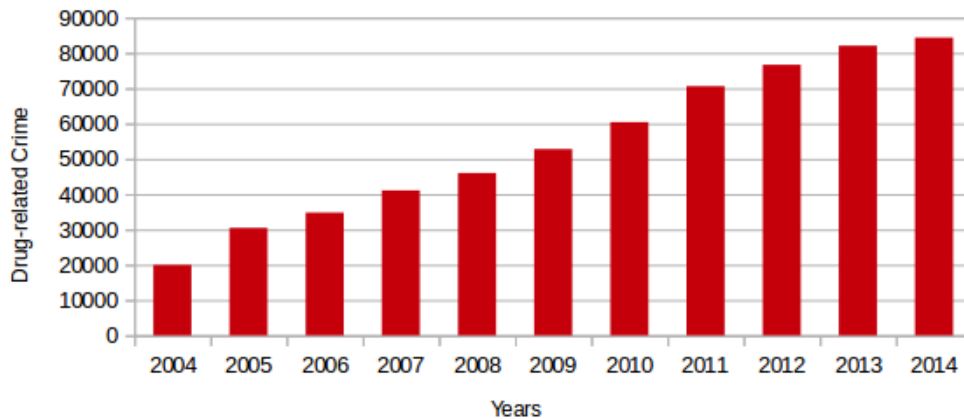

Figure 2.1. Drug-related crime in the Western Cape [64].

After South Africa's transition to democracy in 1994 and subsequent reopening of borders, an influx of and a growing burden of harm associated with illicit drug use [6]. South Africa's geographical location, lax border controls, weak criminal justice system, modern telecommunications and banking systems and international trade links with South America, North America, Asia and Europe caused the country to become a desirable zone for the transshipment of drugs [52]. In the Western Cape, substance abuse accounts for most of the criminal offences in the communities. The offences associated with alcohol and illicit drugs use include possession and sale of illicit drugs, crime to obtain money to purchase drugs and support users' addiction, driving under the influence of alcohol and drugs, child abuse and domestic violence among others [51]. The ISS Crime maps [32] in Figure 2.2, illustrate how drug-related crime has escalated in the Western Cape in the past decade [3, 44, 64].

There are 29 different crime categories used by the SAPS for reporting crime statistics, one of these categories are crimes that are heavily dependent on police action for detection, drug-related crimes are classified within this category. Over 400 drug related crimes are reported daily in South Africa, where of 47% of all drug related crime in South Africa occur in the Western Cape [3]. The worst ten precincts list of 2014 drug-related crime in South Africa highlights the high occurrence of drug-related



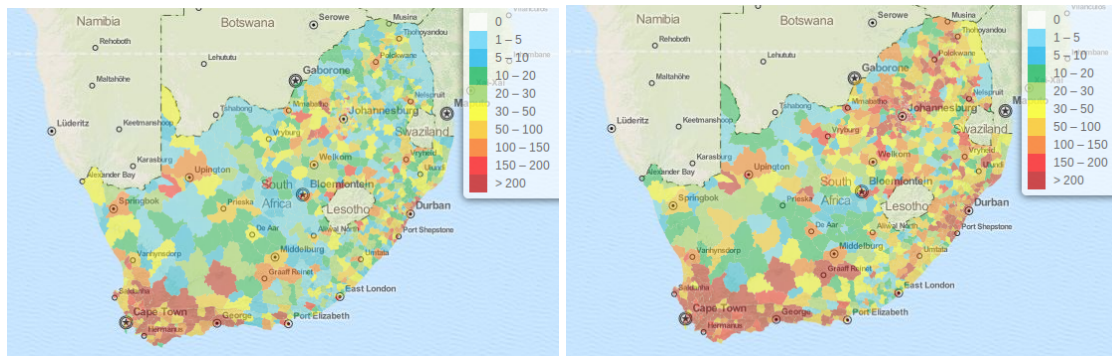

Figure 2.2. Crime maps of South Africa showing police precincts with drug-related crime levels, the more intense the colour the higher the crime level. The escalation of drug-related crime in the past decade is evident from the images, with the crime concentrated in the Western Cape province for the year 2005 and 2014 respectively [32]

crime within the Western Cape, showing six out of the top ten precincts are in the Western Cape province, and constitutes 67.12% of the drug-related crimes in the list. Drug related crimes within the Western Cape is responsible for the majority of cases under the category 'Crimes heavily dependent on police action for detection' in the SAPS annual report of 2012/13, at 82.3% equating to 82062 cases [64]. The SAPS identified relationships between drug abuse and the following crimes: possession of stolen illegal firearms, money laundering, abalone smuggling, burglary, theft of motor vehicles and possession of stolen property. These crimes both support the financial needs to sustain the addiction, conjoint to conceal the trade from authorities. The South African Institute of Race Relations indicated that there were 248 drug related crimes per 100000 of the population in the Western Cape [47]. Substance abuse is listed as the second highest factor creating opportunities for crime at 12% [44]. Addressing substance abuse within the Western Cape province will be an elixir for the safety and development of the communities.

## 2.2 From a systems perspective

### 2.2.1 Systems thinking

Systems thinking in its essence, is conjoint with the field of systems dynamics, founded by MIT professor Jay Forrester in 1956. In the McKinsey Quarterly interview of 1992 [53] Jay Forrester stated that Systems Thinking will get you “ less than 5 percent of the way towards a genuine understanding of systems. The other 95 percent lies in the rigorous System Dynamics-driven structuring of models and in the simulations based on these models”. Barry Richmond’s [7] has a different standing on the definition of systems thinking, “ Systems Thinking is the art and science of making reliable inferences about behaviour by developing an increasingly deep understanding of underlying structure.” Irrespective of the definition, it is important that the two work hand in hand, regardless which one is preferred as the leading hand.

Systems thinking has been defined as an approach to problem solving, by viewing “problems” as parts of an overall system, rather than reacting to a specific part, outcomes or events and potentially contributing to further development of unintended consequences. Systems thinking and systems models is the sum of dynamic and complex relational studies, a non reductionist approach acknowledging context, the nature of causality and non linear relationships as well as the importance of feedback loops, stocks and flows. Systems research and practice recognise and acknowledge dynamic and complex elements and relationships within and between different systems and how they affect organizations, communities, environments and the population at large [2, 54].

Systems thinking focuses on studying the whole, by employing functional and relational principles [54, 60, 61], rather than focusing on the simple elements as preferred in reductionistic mathematical models such as the SIR models. Interrelatedness and emergence are some of the fundamental ideas that systems thinking is built on [55], where an emergent property of a system is a product of the system as a whole. Systems thinking allows us to consider the product of the system and not only that of a single component in the system. Emergent properties are often overseen or misunderstood in the reductionist mathematical models of social systems, since an emergent property of a system

is a product of the system as a whole, and can not be explained by a single component of the system alone.

By building conceptual models that interpret or explain social phenomena by relating different structures that shape our lives like biological, organizational, political and governmental systems [54, 60, 61, 68, 71]. Systems thinking requires critical thinking of researchers in various fields, and holds the possibility to expose assumptions that are systemically flawed in mental and mathematical models that researchers have based their work on. Thus, within systems thinking acts of behaviour within a system are sometimes of more value than exact values produced by the system.

Leischow and Milstein [60] suggested that grounding studies in systems orientation, and approaching health as a system of structured relationships with diverse methodologies will assist us in understanding how these system are organized, sustained and discover the possible ways in which it can be improved within the democratic and dynamic environments. El-Jardi et al.[17] highlighted some of the key barriers and enablers of applying systems thinking in research and practice, among them were: building capacity and awareness, funding and sustainability as well as coordinating and managing partnerships.

Systems thinking and systems dynamics promise new opportunities for active engagement and trans-disciplinary thinking with those who have stake in the outcome to govern the course of change, in order to consider connections among different components and plan for the implications of their interaction [54, 60, 61]. A common theme within systems are their dynamic nature, whether equilibriums, cycles or chaotic behaviour occur. Dynamic change is always present within systems. Complexity of a system rises out of the multiple stake holders that often have different and/or competing goals [71]. This phenomena in systems causes agents to constantly adapt within the system, forming a self-organizing system that is sensitive to pre-existing conditions, and governed by both the actions and reactions of the system actors [17, 54, 71]. Leischow and Milstein [60] recommended health research to use systems principles and orientation, when approaching health hazards such as substance abuse as a system of structured relationships with diverse methodologies. Systems research creates the opportunity to critically

explore what hinders or accelerates adoption of evidence based strategies and promote their implementation [2]. System dynamics will assist us in understanding how these systems are organized, sustained and discover the possible ways in which they can be improved within their democratic and dynamic environments.

### 2.2.2 System dynamics

In 1992 Jay Forrester [53] stated that:

System dynamics is primarily for the design of policy. By policy I mean the rules by which decisions are made. By determining policies, that is, the rules for decision-making, system dynamics establishes how the day-to-day decisions are to be made. A system dynamics model consists of a structure of policies, and shows how the decisions resulting from those policies create corporate stability, growth, market share, and profitability.

System dynamics are concerned with constructing models of the real world in order to study the dynamics and improvising problematic system behaviour located through the models [16]. As Flood (2010) [55] states in the relationship of 'systems thinking' to action research:

*System dynamics creates diagrammatic and mathematical models of feedback processes of a system of interest. Models represent levels of resources that vary according to rates at which resources are converted between these variables. Delays in conversion resulting side-effects are included in models so that they capture in full the complexity of dynamic behaviour. Model simulations then facilitate learning about dynamic behaviour and predict results of various tactics and strategies when applied to the system of interest.*

Systems dynamics are concerned with constructing models of the real world in order to study the dynamics and improvising problematic system behaviour located through the models [16]. As Flood (2010) [55] states in the relationship of 'systems thinking' to action research:

System dynamics creates diagrammatic and mathematical models of feedback processes of a system of interest. Models represent levels of resources that vary according to rates at which resources are converted between these variables. Delays in conversion resulting side-effects are included in models so that they capture in full the complexity of dynamic behaviour. Model simulation then facilitates learning about dynamic behaviour and predicts result of various tactics and strategies when applied to the system of interest.

System dynamics with respect to public health and safety is a multidisciplinary field of study. System dynamics explore system-level properties and outcomes that is a result of the dynamic interactions within the system among the different components of the system, and how those dynamics affect organizations, communities, environments and the populations health . Systems research creates the opportunity to critically explore what hinders or accelerate adoption of evidence based strategies and promote their implementation [2].

Substance abuse, violence and HIV/AIDS often cluster in the same urban populations and such “syndemics” are resistant to narrow policy interventions [25]. The importance and potential of systems thinking with regards to these challenges has been highlighted by many researchers [2, 17, 56, 71]. Systems in general are constantly changing, self-organising, sensitive to pre-existing conditions, and governed by both the actions and reactions of the system actors [17, 54]. Improving a health system is a balancing act for health system stewards and policy makers: “They must weigh the need for disease-specific programming with those targeting the health system as a whole; national priorities with global initiatives; and policy directives with ‘street level’ realities”[2].

In summary, systems consists of a transdisciplinary integration that aims to reconcile linear and non-linear, qualitative and quantitative, reductionist and holistic thinking and methods into union to of approaches to systems thinking and systems dynamics [71]. As Leischow et al. [61] explained that most causations of diseases, as substance abuse in this case, are nonlinear, dynamic and multifactorial. Systems reflect both the functional and conceptual areas together of the substance abuse itself, as well as the burden on its environment for instance drug-related crime, resulting in a sum greater than

the individual contributions. Swanson et al [54] explained that even though systems are not a recent concept, “adaptive systems presents novel opportunities for synergy and increasing capacity in local communities and organizations”. Leischow et al. [61] explained how most causations of diseases, as substance abuse in this case, are non linear, dynamic and multi factorial. Dynamic systems consist of a trans-disciplinary integration that aims to reconcile linear and non-linear, qualitative and quantitative, reductionist and holistic thinking and methods into union [71]. Systems thinking reflect both the functional and conceptual areas of substance abuse, as well as the burden it has on its environment namely drug-related crime.

### 2.2.3 STELLA

Feedback systems with dynamic behaviour are at the core of system dynamics. Casual loop diagrams are often used in understanding the structure of a system, but are often found inadequate to explain the intricate behaviour of the system. Modelling a system with software like Structural Thinking, Experiential Learning Laboratory with Animation (STELLA) capacitate one to elucidate the behaviour of a system that is embedded within its given structure.

STELLA has stocks, flows, converters and connectors as shown in Figure 2.2.3 which the user can use to visually construct a model to represent the system. The procedure of building the model require the user to make explicit assumptions with regards to the system. Stocks and flows are the infrastructure of the system. Relationships within the system are depicted by stocks that are increased and decreased by flows, and the flows are governed by converters and connectors. Parameters and constant converters serve as input into the system. A continuous process of building the model and running simulations allows the testing of the validity of the assumptions made during the formulation of the model. This recurring trail and test method within STELLA encourages critical thinking. Whilst using systems models within platforms like STELLA one should always be critical of the parameters and what one assumes about the relationship between the parameters within the analytical methods and program practices [60].



Figure 2.3. Basic modelling icons in STELLA used as building blocks for a system.

A stock is something that accumulates over time, it cannot change instantly, but it is altered through flows (inflows and outflows). The stock can only change by a rate dictated by the flows. Thus, a stock is the representation of the net flow at a specific point in time. Stocks and flows are mathematically speaking differential and integral equations. The flow between the many interrelated parts in the system is governed by feedback loops, there are two types of feedback loop: negative feedback loops also known as balancing feedback loops and positive feedback loops also known as amplifying/reinforcing loops [55]. Balancing loops assists the system in re-establishing standard conditions, contrary to amplifying loops that lead to the growth of a trend. The interplay of these different loops lead to steady states; where the emergent whole at the end result is known as a finite one. The system as a whole will either be balancing, and reach a steady state that cause the various stocks to plateau after a certain period of time, or the system will be amplifying causing certain stocks to grow endlessly. Whilst using systems models in a platform such as STELLA, one should take cognisance of the parameters and what one assumes about the relationship between the parameters within the analytical methods and program practices [60].

## 2.3 Models of substance abuse and drug-related crime

The evolution of drug abuse within communities are similar to those of diseases [22, 23, 24, 43, 59], where initiation of the susceptible population, into drug use being similar to that of commutable diseases. Mathematical models on substance abuse have been formulated and analyzed by various authors in recent years [57, 59, 14]. Insightful findings have been established on the dynamics of substance abuse, specifically concerning the initiation drug users being dependant on interaction between the drug users and the population at risk [8, 22, 43]. Buonomo and Lacticignola [11] expanded models like these, by taking imitation as well as innovation into account when considering initiation into

substance abuse. Individuals that decide to adopt an innovation independently of other individuals in the social system are called innovators [11], whereas imitators/adopters represent the individuals whose behaviours and decisions are based on contact or interaction with others within the social system [23].

General compartmental models for disease transmission that are based on ordinary differential equations (ODEs) have a disease free equilibrium (DFE), at which the disease is absent in the population. A threshold parameter known as the basic reproduction number  $\mathcal{R}_0$  is usually associated with these models and of importance in order to understand the dynamics of the epidemic. Mathematically, the reproduction number is the rate at which an infectious individual produces new cases (assuming that the whole population is susceptible), multiplied by the average infectious period [70]. In simple terms,  $\mathcal{R}_0$  is the number of expected secondary cases produced by an infective individual, in a completely susceptible population. When  $\mathcal{R}_0 < 1$ , the DFE is locally asymptotically stable, establishing that the disease cannot invade the population. Although, if  $\mathcal{R}_0 > 1$ , then the DFE is unstable and invasion is possible [12]. The reproduction number is at the core of studying infectious diseases, and therefore substance abuse as well, in order to predict and determine parameters that enhance or reduce the growth of the epidemic. Sensitivity analysis has been proven to be useful in testing the validity of mathematical models for epidemics, by getting a finer understanding of the parameters in the model, specifically those in the reproduction number [70]. Various methods are used in literature to do sensitivity analysis such as differential sensitivity analysis, factorial design, one-at-a-time sensitivity measures, importance factors and subjective sensitivity analysis [13]. Sensitivity analysis is used to model uncertainty about the values of the inputs by treating them as random variables. McKay [40], mentioned and compared three different methods of selecting values of input variables when doing sensitivity analysis, namely: (1) Random sampling, (2) Stratified sampling and (3) Latin Hypercube Sampling (LHS). LHS has been used successfully to investigate the reproduction number within drug abuse models [23, 70].

White and Gorman [14] explained the complex relationship between drugs and crime through three models: “ (1) substance use leads to crime, (2) crime leads to substance use, and (3) the relationship is either coincidental or explained by a set of common



causes". These models explain the different reasons why crimes are being committed by drug-using offenders. Although a single model cannot explain the entire drug-crime system, the relationship between drugs and violence involve a broad spectrum of social, political and economic forces, the environment of the individuals abusing substances, and the biological processes driving human behaviour to an extent [37]. In the PNP Report of 2013/14 the Department of Community Safety reported that substance abuse in the Western Cape falls within each of the three facets of the conceptual model they constructed in order to understand crime, namely (1) causes, (2) motivation and (3) opportunities [44]. This supports the assumption that the interaction between substance abuse and drug associated crime is wide spread and complex of nature.

In the case where substance use leads to crime, Goldstein's causal model postulates that substance use lead to crime due to the psychopharmacological properties of drugs, the economic motivation to obtain drugs or the systemic violence affiliated with the illegal drug market [50]. The psychopharmacological model suggest that the effects of intoxication cause criminal behaviour [34, 35]. The economic motivation model presumes drug users are dependent on to generate illicit income to support their drug dependency, hence they engage in criminal activity to get drugs or the money to buy them. The systemic model was developed during the 1980's [49], which assumes the system of drug distribution and use is intrinsically connected with violent crime. In the case where crime leads to substance use, the presumption is that divergent individuals are more prone to adopt or imitate social situations in which substance use are accepted and even encouraged. White [31] clarified by stating that the involvement in a criminal subculture provides context, reference group and the conditions that are conducive to involvement with drugs.

The Initiative on the Study and Implementation of Systems (ISIS) in the US is an exemplar of showing the potential of addressing chronic diseases by means of systems thinking in order to inform strategic decision making about the most effective ways of reducing tobacco use and tobacco-related disease [54, 61]. Systems have also aided in the progression in a variety of health care processes [41], and training of health service providers [33]. The connected domains across alcohol, tobacco and illicit drugs are: (1) social availability (2) promotion (3) community norms and (4) individual level factors [30]. These different domains and how they interact can be studied through a systems

model. The complex nature of health practices on the other hand are formed by the following actors: Governmental entities at the international, national, regional and local levels, non-governmental organisations and citizens of the public at large [71].

A large portion of the research available on drug abuse, specifically for South Africa is descriptive in nature, often not providing translatable findings or implications for public health practices or assisting in constructing sustainable policies with regards to public health. Systems research introduces a way to integrate both non-mathematical and mathematical research. Swanson et al. [54] explained that even though systems approach is not a new concept, “adaptive systems present novel opportunities for synergy and increasing capacity in local communities and organizations.” Through systems thinking, researchers are equipped to identify and understand factors that hinder or accelerate adoption of quantitative evidence-based strategies and promote their use [68]. System dynamics allow one to consider the accumulating effects we see within communities of people, information, material and financial assets, biological and psychological states. It sheds light on how the complex behaviours of both the social and organisational systems are balanced and reinforces feedback loops [25].

The increased prevalence of crime associated with substance abuse underscores the importance of examining the system of interacting processes and feedback loops that are associated with substance abuse and drug related crimes. It is imperative to first take into account what the local culture, context and politics are when considering a system’s solution [28]. To have a better understanding of the context of substance abuse and drug-related crime in the Western Cape, we explore how a Systems Thinking and Systems Dynamics perspective can address the current problematic system within the Western Cape communities. As the WHO advised the public health sector : “... a system’s failure requires a system’s solution - not a temporary remedy.”[48]. Addressing substance abuse within the province will be a elixir for the safety and development of the communities.

The complexity of the drug abuse and drug-related crime system in South Africa is rising from its’ interconnected parts and its adaptivity, adjusting and changing in unpredictable and uncontrollable ways. The connected domains across alcohol, tobacco and illicit drugs are: (1) social availability (2) promotion (3) community norms and (4) in-

dividual level factors [30]. These different domains and how they interact can be studied through a systems model. The complex nature of health practices on the other hand are formed by the following actors: Governmental entities at the international, national, regional and local levels, non-governmental organisations and citizens of the public at large [71].

Our work will now focus on the syndemic substance abuse and drug-related crime in Western Cape during the time period 2004 – 2014. The majority of research on substance abuse in South Africa are descriptive studies, often lacking translatable findings or implication for the police enforcement and judiciary system fighting the drug-related crimes that have been constantly rising of the past 10 years. The Western Cape has an estimated population of 5.82 million people according to Statistics South Africa [67], displaying an increase in the population since 2004 that could be attributed to work migration, since people in South Africa tend to leave their provinces or usual residences in search for work in industrialised provinces like the Western Cape. In 2004, 4563 patients were treated for rehabilitation in Cape Town (from 1998 – 2006 SACENDU reported only on Cape Town in the Western Cape), and in 2013 7195 patients were treated across the Western Cape, indicating a 63.4% in admissions [19]. Since the 2003/2004 annual report of the SAPS, a significant increase of 311.5% have been recorded for drug-related crime. Both the growing population of drug users as well as the lucrative drug market that supports and feeds the increase in supply and demand mechanisms for the drug system is responsible for this increase of annual cases from 19940 in 2003/2004 to 82062 in 2012/2013 [64]. Focusing on treatment of drug-involved offenders offers the opportunity to reduce substance abuse and drug-related criminal behaviour respectively [9]. This was the motivation for including Police Enforcement and Correctional Services, as well as the Judiciary into the SIR epidemic model of substance abuse, and therefore consider the syndemic of substance abuse and drug-related crime.

## Chapter 3

# Deterministic model for the substance abuse and drug-related crime syndemic

### 3.1 Introduction

The deterministic model of the syndemic of substance abuse and drug-related crime in the Western Cape is based on the conceptual model illustrated in Figure 1.5 and discussed in Chapter 1. In this Chapter, we use a mathematical model which is an extension of the classical SIR model by investigating the dynamics of a syndemic of substance abuse and drug-related crime. Initiation into drug use and drug-related crime is dependent on both imitation and innovation [11]. Imitation is due to contact of those at risk (the susceptible population) with drug users or drug-related criminals. Innovators are assumed to be individuals that start using drugs out of curiosity or those who enter drug-related crime circles out of the challenges faced, which can be poverty or gang related. We evaluate the drug threshold ratio and use it to analyse the model. The conditions under which the drug problem can be contained are highlighted. Sensitivity analysis of the model parameters to the model output is done by using the Latin Hypercube Sampling (LHS) method.

### 3.1.1 Model formulation

The model analyses the dynamics of substance abuse and drug-related crime in a heterogeneous population. The population is classified into four compartments: those at risk of using drugs or taking part in drug-related crime (susceptible) denoted by  $C$ , those using drugs and taking part in drug-related crime  $D$ , individuals undergoing rehabilitation as  $R$  and offenders that are successfully sentenced are in correctional services  $S$ . The total variable population size at any time  $t$  is given by

$$N(t) = C(t) + D(t) + S(t) + R(t). \quad (3.1)$$

We assume that the individuals in each compartment are indistinguishable and that there is homogeneous mixing. The model assumes that individuals join the susceptible population at a rate  $\Pi$  through births and immigration. Susceptible individuals are initiated into drug use and drug-related crime following interaction with individuals using drugs or taking part in drug-related crime. Thus, we assume an initiation function that is analogous to the force of infection for epidemic models [22, 23, 24, 43, 59]. For initiation to occur, the per capita contact rate  $\beta$  is a product of the effective number of contacts between the population at risk  $C$  and the drug users and individuals in drug-related crime  $D$ . The result of innovation, represented by  $\eta$  in (3.2), is also taken into consideration in the initiation function similar to the one proposed in [11]. Innovators are individuals adopt an innovation such as drug use independent of the decisions of other individuals in the social system. The standard incidence of  $C$  and  $D$  is dependant on the fraction of  $C$  in the general population. Therefore, the total number of relevant contacts give rise to the initiation function,

$$\lambda = \beta D \left( \frac{1 + \eta D}{N} \right). \quad (3.2)$$

Upon initiation into drugs, a susceptible individual moves into the compartment of drug use and drug-related crime. Those in  $D$  can either stop (based on self efficacy) and go back to  $C$ , join a rehabilitation program and move to  $R$ , go to a correctional service  $S$  or be removed due to death caused by drug use or crime. Individuals serving time in a correctional service can be referred to a rehabilitation centre and move to  $R$ ,

successfully complete sentences and go back to  $C$  or be removed due to death. Once in rehabilitation, individuals can either relapse back into  $D$ , are successfully rehabilitated and go to  $C$  or they die. The possible transitions for individuals in the substance abuse and drug-related crime system are represented by the schematic diagram in Figure 3.1. The descriptions of the parameters that describe the flow rates between compartments are given in Table 3.1

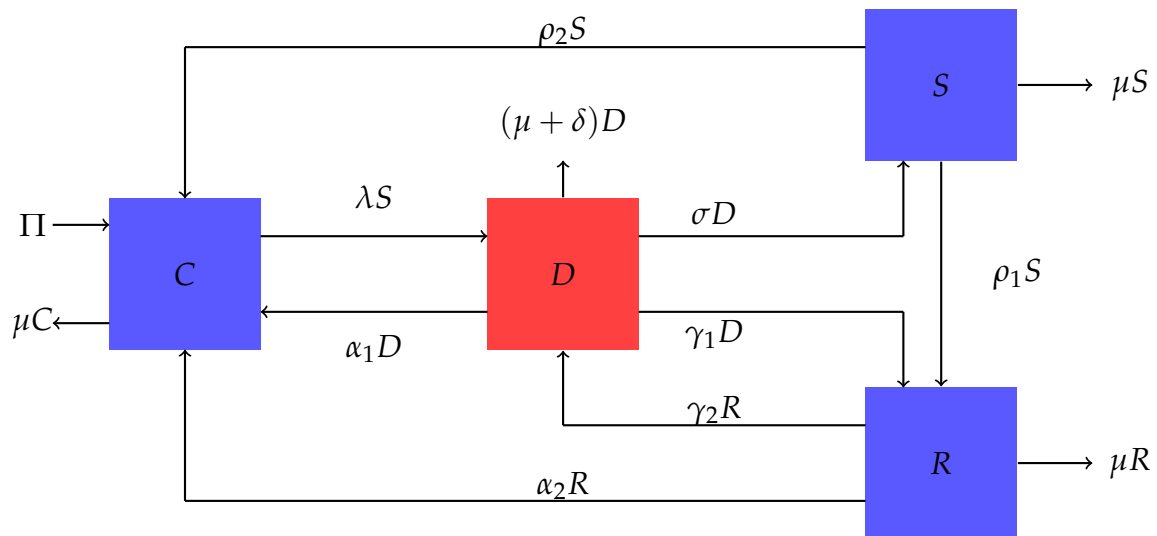

Figure 3.1. A compartmental representation for the model of the syndemic of substance abuse and drug-related crime.

Table 3.1. Description of parameters used in the model.

Symbol	Description
$\Pi$	Recruitment rate into the susceptible population
$\mu$	Natural mortality rate of the population
$\beta$	The effective contact rate between the susceptible population and drug users
$\eta$	Innovation parameter
$\alpha_1$	The mean rate at which users quit and become susceptible again
$\alpha_2$	The mean rate at which those in rehabilitation are rehabilitated
$\gamma_1$	The mean rate users are recruited into rehabilitation
$\gamma_2$	The mean rate at which those in rehabilitation relapse into drug use
$\sigma$	The mean rate at which those in drug-related crime are sentenced to correctional services
$\rho_1$	The mean rate at which offenders are referred to rehabilitation
$\rho_2$	The mean rate at which offenders complete sentences and become susceptible again
$\delta$	Rate of removal due to drug use and crime

The system of ordinary differential equations that represent the compartmental model

is

$$\begin{aligned}
 \frac{dC}{dt} &= \Pi + \rho_2 S + \alpha_2 R + \alpha_1 D - \lambda C - \mu C, \\
 \frac{dD}{dt} &= \lambda C + \gamma_2 R - Q_1 D, \\
 \frac{dS}{dt} &= \sigma D - Q_2 S, \\
 \frac{dR}{dt} &= \gamma_1 D + \rho_1 S - Q_3 R,
 \end{aligned} \tag{3.3}$$

where

$$\begin{aligned}
 Q_1 &= \mu + \alpha_1 + \gamma_1 + \sigma + \delta, \\
 Q_2 &= \mu + \rho_1 + \rho_2, \\
 Q_3 &= \mu + \gamma_2 + \alpha_2.
 \end{aligned}$$

We assume that all the model parameters are positive and the initial conditions of the model system (3.3) are given by

$$C(0) = C_0 > 0, D(0) = D_0 \geq 0, S(0) = S_0 \geq 0 \text{ and } R(0) = R_0 \geq 0.$$

### 3.1.2 Basic properties of the syndemic model

#### Positivity of solutions of the model

We now consider the positivity of solutions of the system of equations (3.3). We prove that all the state variable remain non-negative and the solutions of the system (3.3) with positive initial conditions will remain positive for all  $t > 0$ . We thus state the following theorem.

**Theorem 3.1.1.** *Given that the initial conditions of system (3.3) are  $C_0 > 0, D_0 > 0, S_0 > 0$  and  $R_0 > 0$ , the solutions of  $C(t), D(t), S(t)$  and  $R(t)$  are non-negative for all  $t > 0$ .*

*Proof.* Assume that

$$\hat{t} = \sup\{t > 0 : C > 0, D > 0, S > 0, R > 0\} \in [0, t].$$

Thus,  $\hat{t} > 0$ , and it follows directly from the first equation of the system (3.3) that

$$\frac{dC}{dt} \geq \Pi - (\lambda + \mu)C. \quad (3.4)$$

We use the integrating factor method to solve the inequality (3.4). The resulting inequality can be written as,

$$\frac{dC}{dt} + (\lambda + \mu)C \geq \Pi.$$

Using the integrating factor,

$$IF = e^{\int_0^z (\lambda(z) + \mu) dz} = e^{\mu t + \int_0^t \lambda(z) dz},$$

we have

$$\frac{d}{dt} \left[ C(t) e^{\mu t + \int_0^t \lambda(z) dz} \right] \geq e^{\mu t + \int_0^t \lambda(z) dz}$$

Integrating both sides we obtain

$$\begin{aligned} C(\hat{t}) e^{\mu \hat{t} + \int_0^{\hat{t}} \lambda(z) dz} - C(0) &\geq \int_0^{\hat{t}} \Pi e^{\mu t + \int_0^t \lambda(\omega) d\omega} d\hat{t}, \\ C(\hat{t}) &\geq C(0) e^{-\left(\mu \hat{t} + \int_0^{\hat{t}} \lambda(z) dz\right)} + e^{-\omega \hat{t} + \int_0^{\hat{t}} \lambda(z) dz} \left[ \int_0^{\hat{t}} \Pi e^{\left(\mu \hat{t} + \int_0^{\hat{t}} \lambda(\omega) d\omega\right)} d\hat{t} \right], \\ &> 0, \quad \forall \hat{t} > 0. \end{aligned}$$

From the second equation in (3.3) we have

$$\begin{aligned} \frac{dD}{dt} &= \lambda(C) + \gamma_2 R - Q_1 D \\ &\geq -Q_1 D. \end{aligned}$$

We separate variables and integrate both sides with respect to the corresponding variables as follow,

$$\begin{aligned} \int \frac{dD}{D} &\geq \int -Q_1 dt \\ \ln(D) &\geq -Q_1 t + k. \end{aligned}$$



when  $t = 0, k = \ln(D(0))$ . Then we have

$$\begin{aligned}\ln(D) &= -Q_1 t + \ln(D_0), \\ D &\geq D_0 e^{-Q_1 t} > 0.\end{aligned}$$

Similarly, it can be shown that  $S(t) \geq S_0 e^{-Q_2 t} > 0$  and  $R(t) \geq R_0 e^{-Q_3 t} > 0$  for all  $t > 0$ , and this completes the proof.  $\square$

### Boundedness of the state space variable

Since the model monitors changes in the human population, the variables and the parameters are assumed to be positive for all  $t \geq 0$ . The analysis of system (3.3) will therefore be performed in a region  $\mathcal{D}$  of biological interest. We have the following lemma on the region that system (3.3) is restricted to.

**Theorem 3.1.2.** *The feasible region  $\mathcal{D}$  defined by*

$$\mathcal{D} = \left\{ (C(t), D(t), S(t), R(t)) \in \mathbb{R}_+^4 \mid 0 \leq N \leq \frac{\Pi}{\mu} \right\},$$

*with initial conditions  $C_0 \geq 0, D_0 \geq 0, S_0 \geq 0$  and  $R_0 \geq 0$ , is positively invariant and attracting with respect to system (3.3) for all  $t > 0$ .*

*Proof.* The total population in this model is clearly not constant. Therefore, the evolution equation for the change in the population is given by

$$\begin{aligned}\frac{dN}{dt} &= \Pi - \mu N - \delta D, \\ &\leq \Pi - \mu N.\end{aligned}$$

It can easily be shown that

$$N \leq \frac{\Pi}{\mu} + \left( N_0 - \frac{\Pi}{\mu} \right) e^{-\mu t} \text{ where } N(0) = N_0.$$

We observe that as  $t \rightarrow \infty, N(t) \rightarrow \frac{\Pi}{\mu}$  implying that  $\lim_{t \rightarrow \infty} N(t) = \frac{\Pi}{\mu}$ . Clearly,  $\frac{\Pi}{\mu}$  is the upper bound of  $N$ . On the other hand, if  $N_0 > \frac{\Pi}{\mu}$ , then  $N$  will decrease to  $\frac{\Pi}{\mu}$  as

$t \rightarrow \infty$ . This means that if  $N_0 > \frac{\Pi}{\mu}$ , then the solution  $(C(t), D(t), S(t), R(t))$  enters  $D$  or approaches it asymptotically. Therefore,  $\mathcal{D}$  is positively invariant under the flow induced by system (3.3). Thus, in  $\mathcal{D}$  the model (3.3) is well-posed. Hence, it is sufficient to study the dynamics of the model in  $\mathcal{D}$ .  $\square$

## 3.2 Model analysis

### 3.2.1 The drug-free equilibrium and the basic reproduction number

The drug-free equilibrium (DFE) for the system (3.3) is given by,

$$\mathcal{E}_0(C^*, D^*, S^*, R^*) = \left( \frac{\Pi}{\mu}, 0, 0, 0 \right).$$

The basic reproduction number in this model, namely  $\mathcal{R}_0$ , represents the number of expected secondary cases (substance abusers) produced by one individual that is abusing a substance in a completely susceptible population.  $\mathcal{R}_0$  is determined by the next generation matrix method [12]. A reproduction number obtained this way determines the local stability of the drug-free equilibrium point. Using the approach in [12] and adopting the matrix definitions, the matrices for new infection terms and the transfer terms between compartments are respectively given by,

$$f = \begin{pmatrix} \lambda(C) \\ 0 \\ 0 \end{pmatrix} = \begin{pmatrix} \frac{BCD(1+\eta D)}{C+D+S+R} \\ 0 \\ 0 \end{pmatrix} \text{ and } v = \begin{pmatrix} -\gamma_2 R + Q_1 D \\ -\sigma D + Q_1 \\ -\gamma_1 D - \rho_1 S + Q_3 R \end{pmatrix}.$$

Differentiating the matrices  $f$  and  $v$  with respect to  $D, S$  and  $R$  and evaluating the result at the DFE, we have the final matrices for new infection terms and the transfer between compartments at the drug-free equilibrium given respectively by,

$$\mathcal{F} = \begin{pmatrix} \beta & 0 & 0 \\ 0 & 0 & 0 \\ 0 & 0 & 0 \end{pmatrix}, \text{ and } \mathcal{V} = \begin{pmatrix} Q_1 & 0 & -\gamma_2 \\ -\sigma & Q_2 & 0 \\ -\gamma_1 & -\rho_1 & Q_3 \end{pmatrix},$$

where

$$Q_1 = \mu + \alpha_1 + \gamma_1 + \sigma + \delta, \quad Q_2 = \mu + \rho_1 + \rho_2 \quad \text{and} \quad Q_3 = \mu + \gamma_2 + \alpha_2.$$

The inverse of  $\mathcal{V}$  is given as,

$$\mathcal{V}^{-1} = \begin{bmatrix} \frac{1}{Q_1(1-\Phi)} & \frac{\gamma_2\rho_1}{Q_1Q_2Q_3(1-\Phi)} & \frac{\gamma_2}{Q_1Q_3(1-\Phi)} \\ \frac{\sigma}{Q_1Q_2(1-\Phi)} & \frac{(1-\Phi_1)}{Q_2(1-\Phi)} & \frac{\sigma\gamma_2}{Q_1Q_2Q_3(1-\Phi)} \\ \frac{Q_2\gamma_1+\sigma\rho_1}{Q_1Q_2Q_3(1-\Phi)} & \frac{\rho_1}{Q_2Q_3(1-\Phi)} & \frac{1}{Q_3(1-\Phi)} \end{bmatrix},$$

where  $\Phi = \Phi_1 + \Phi_2$ ,  $\Phi_1 = \frac{\gamma_1}{Q_1} \cdot \frac{\gamma_2}{Q_3}$  and  $\Phi_2 = \frac{\sigma}{Q_1} \cdot \frac{\rho_1}{Q_2} \cdot \frac{\gamma_2}{Q_3}$ .

The basic reproduction number is given as the spectral radius of the matrix  $\mathcal{F}\mathcal{V}^{-1}$ , thus

$$\mathcal{R}_0 = \rho(\mathcal{F}\mathcal{V}^{-1}) = \frac{\beta}{Q_1(1-\Phi)}.$$

The term  $\Phi_1$  represents the individuals that move back and forth between the compartments  $D$  and  $R$ . The term  $\Phi_2$  represents the proportion of individuals who cycle through compartments  $D$ ,  $S$  and  $R$ . Where,  $\frac{\gamma_2}{Q_3}$  is the proportion of individuals who relapse,  $\frac{\gamma_1}{Q_1}$  is the proportion of individuals who are taken up into rehabilitation,  $\frac{\sigma}{Q_1}$  is the proportion of individuals that move from  $D$  to  $S$  and  $\frac{\rho_1}{Q_2}$  is the proportion of individuals that are referred to  $R$  from  $S$ . Hence, we see that  $\Phi_2$  indicates the cycle  $D \rightarrow S \rightarrow R \rightarrow D$ .

Following [23], we have the following result;

**Theorem 3.2.1.** *The drug-free equilibrium  $\mathcal{E}_0$  of system (3.3) is locally asymptotically stable whenever  $\mathcal{R}_0 < 1$  and unstable otherwise.*

### 3.2.2 Global stability of the drug-free steady state

In this section we prove the global stability of the drug-free equilibrium  $\mathcal{E}_0$  when  $\mathcal{R}_0 < 1$ , using a suitable Lyapunov function.

**Theorem 3.2.2.** *The drug-free equilibrium  $\mathcal{E}_0$  is globally stable when  $\mathcal{R}_0 < 1$  and unstable*

otherwise.

*Proof.* Let  $V = \zeta D + \vartheta S + \chi R$  be a candidate Lyapunov function for some non-negative constants  $\zeta, \vartheta$ , and  $\chi$ . The derivative of the Lyapunov function with respect to time is given by

$$\begin{aligned} \frac{dV}{dt} &= \zeta \frac{dD}{dt} + \vartheta \frac{dS}{dt} + \chi \frac{dR}{dt}, \\ &= \zeta \left[ \frac{\beta CD(1 + \eta D)}{N} + \gamma_2 R - Q_1 D \right] + \vartheta [\sigma D - Q_2 S] + \chi [\gamma_1 D - Q_3 R]. \end{aligned}$$

We note that  $C \leq \frac{\Pi}{\mu}$  and  $N \leq \frac{\Pi}{\mu}$  then  $\frac{C}{N} \leq 1$ . The time derivative of the Lyapunov function becomes

$$\begin{aligned} \frac{dV}{dt} &\leq \zeta [\beta D(1 + \eta D) + \gamma_2 R - Q_1 D] + \vartheta [\sigma D - Q_2 S] + \chi [\gamma_1 D - Q_3 R], \\ &\leq (\zeta \beta - Q_1 \zeta + \vartheta \sigma + \chi \gamma_1) D - \vartheta Q_2 S + (\zeta \gamma_2 - \chi Q_3) R. \end{aligned}$$

We now equate the coefficients of  $D$  and  $R$  to zero so that

$$0 = \zeta \beta - Q_1 \zeta + \vartheta \sigma + \chi \gamma_1, \quad (3.5)$$

$$0 = \zeta \gamma_2 - \chi Q_3. \quad (3.6)$$

From (3.6) we have  $\chi = \frac{\gamma_2}{Q_3}$ . If we let  $\chi = \gamma_2$ , then  $\zeta = Q_3$  so that

$$\vartheta = \frac{Q_1 Q_3 (1 - \Phi)(1 - R_0)}{\sigma}.$$

Substituting the coefficients  $\zeta, \vartheta$  and  $\chi$  into the Lyapunov function, we find

$$\frac{dV}{dt} \leq \frac{-Q_1 Q_2 Q_3 (1 - \Phi)}{\sigma} (1 - R_0) S.$$

We note that when  $\mathcal{R}_0 < 1$ ,  $\frac{dV}{dt} < 0$ . Hence by the LaSalle invariance principle [36],  $\mathcal{E}_0$  is globally stable.  $\square$

### 3.2.3 The drug persistent equilibrium

Let the drug-persistent equilibrium be  $\mathcal{E}^* = (C^*, D^*, S^*, R^*)$ . In this section we determine the drug-persistent steady state by setting the left hand side of system (3.3) to zero, so that

$$0 = \Pi + \rho_2 S^* + \alpha D^* - \lambda^* C^* - \mu C^*, \quad (3.7)$$

$$0 = \lambda^* C^* + \gamma_2 R^* - Q_1 D^*, \quad (3.8)$$

$$0 = \sigma D^* - Q_2 S^*, \quad (3.9)$$

$$0 = \gamma_1 D^* + \rho_1 S^* - Q_3 R^*. \quad (3.10)$$

From equation (3.9), we have

$$S^* = \Psi_1 D^*, \quad (3.11)$$

where

$$\Psi_1 = \frac{\sigma}{Q_2}.$$

Substituting (3.11) into (3.10), we obtain

$$R^* = \Psi_2 D^*, \quad (3.12)$$

where

$$\Psi_2 = \frac{\gamma_1 + \rho_1 \Psi_1}{Q_3}.$$

We now substitute (3.11) and (3.12) in (3.8), we obtain

$$D^* \left( -Q_1 + \gamma_2 \Psi_2 + \frac{C^* \beta (1 + D^* \eta)}{C^* + D^* + D^* (\Psi_1 + \Psi_2)} \right) = 0.$$

From where we obtain  $D^* = 0$  and from the remaining expression we have (with  $\Psi_3 = \Psi_1 + \Psi_2$ ),

$$C^* = \frac{D^* Q_1 (1 - \phi) (1 + \Psi_3)}{D^* \beta \eta + Q_1 (1 - \phi) (\mathcal{R}_0 - 1)}. \quad (3.13)$$

$D^* = 0$  corresponds to the drug free equilibrium, whose stability analysis has already been established.

We now combine (3.7) and (3.8), and substitute for  $S^*$ ,  $R^*$  and  $C^*$  in order to obtain the

polynomial,

$$\begin{aligned}
0 = & D^{*2}\beta^2\eta^2(\Pi + D^*\alpha_1 + D^*\rho_2\Psi_1)(1 + \Psi_1 + \Psi_2) - (-1 + \phi)^2Q_1^2(D^*(-1 + \mathcal{R}_0)\beta \\
& (1 + D^*\eta) + D^*\mathcal{R}_0\mu - (-1 + \mathcal{R}_0)\mathcal{R}_0\Pi + (-1 + \mathcal{R}_0)(\Psi_1(D^*\mu + \Pi - \mathcal{R}_0\Pi - D^*\rho_2 \\
& (\mathcal{R}_0 + (-1 + \mathcal{R}_0)\Psi_1)) + (D^*\mu + \Pi - \mathcal{R}_0\Pi - D^*(-1 + \mathcal{R}_0)\rho_2\Psi_1)\Psi_2) + (D^*(-1 + \mathcal{R}_0)\beta \\
& (1 + D^*\eta) + D^*(1 + \mathcal{R}_0)\mu + \Pi - \mathcal{R}_0\Pi + D^*(-1 + \mathcal{R}_0)((\mu - \rho_2)\Psi_1 + \mu\Psi_2))\Psi_3 + D^*\mu\Psi_3^2 \\
& - D^*(-1 + \mathcal{R}_0)\alpha_1(\mathcal{R}_0 + (-1 + \mathcal{R}_0)\Psi_1 + (-1 + \mathcal{R}_0)\Psi_2 + \Psi_3)) + D^*\beta\eta(-1 + \phi) \\
& Q_1(D^*(\beta + D^*\beta\eta + \mu) + \Pi - 2\mathcal{R}_0\Pi - 2D^*(-1 + \mathcal{R}_0)\rho_2\Psi_1^2 + (D^*\mu - 2(-1 + \mathcal{R}_0)\Pi)\Psi_2 \\
& + (D^*(\beta + D^*\beta\eta + \mu) - \Pi + D^*\mu\Psi_2)\Psi_3 - D^*\alpha_1(-1 + 2\mathcal{R}_0 + 2(-1 + \mathcal{R}_0)\Psi_1 \\
& + 2(-1 + \mathcal{R}_0)\Psi_2 + \Psi_3) + \Psi_1(D^*\mu + 2\Pi - 2\mathcal{R}_0\Pi + D^*\mu\Psi_3 - D^*\rho_2(-1 \\
& + 2\mathcal{R}_0 + 2(-1 + \mathcal{R}_0)\Psi_2 + \Psi_3))). \tag{3.14}
\end{aligned}$$

The polynomial (3.14) can be simplified into a cubic equation given by

$$\mathcal{H}(D^*) = \mathcal{G}_3D^3 + \mathcal{G}_2D^2 + \mathcal{G}_1D + \mathcal{G}_0 = 0, \tag{3.15}$$

where

$$\begin{aligned}
\mathcal{G}_3 = & -\frac{1}{\mu + \alpha_2 + \gamma_2} \left( (\mu + \alpha_2)(\delta + \mu + \gamma_1) + (\delta + \mu)\gamma_2 + \frac{\sigma\alpha_2(\mu + \rho_1) + \mu\sigma(\mu + \gamma_2 + \rho_1)}{\mu + \rho_1 + \rho_2} \right), \\
\mathcal{G}_2 = & \beta\eta(\beta\eta\Pi(1 + \Psi_1 + \Psi_2) - (-1 + \mathcal{R}_0)(-1 + \phi)^2Q_1^2(1 + \Psi_3) + (-1 + \phi)Q_1(\beta + \mu \\
& + \mu\Psi_1 + \mu\Psi_2 - (\alpha_1 + \rho_2\Psi_1)(-1 + 2\mathcal{R}_0 + 2(-1 + \mathcal{R}_0)\Psi_1 + 2(-1 + \mathcal{R}_0)\Psi_2) + (\beta + \mu)\Psi_3 \\
& + (-\alpha_1 + (\mu - \rho_2)\Psi_1 + \mu\Psi_2)\Psi_3)), \\
\mathcal{G}_1 = & -(-1 + \phi)Q_1(\beta\eta\Pi(-1 + 2\mathcal{R}_0 + 2(-1 + \mathcal{R}_0)\Psi_1 + 2(-1 + \mathcal{R}_0)\Psi_2 + \Psi_3) \\
& + (-\mathcal{R}_0 + \phi)Q_1(-(-1 + \mathcal{R}_0)^2\rho_2\Psi_1^2 - (-1 + \mathcal{R}_0)\alpha_1(\mathcal{R}_0 + (-1 + \mathcal{R}_0)\Psi_1 \\
& + (-1 + \mathcal{R}_0)\Psi_2 + \Psi_3) + (1 + \Psi_3)((-1 + \mathcal{R}_0)\beta + \mathcal{R}_0\mu + \mu((-1 + \mathcal{R}_0)\Psi_2 + \Psi_3)) \\
& + (-1 + \mathcal{R}_0)\Psi_1(\mu(1 + \Psi_3) - \rho_2(\mathcal{R}_0 + (-1 + \mathcal{R}_0)\Psi_2 + \Psi_3))), \\
\mathcal{G}_0 = & (\mathcal{R}_0 - 1)\Pi(1 - \phi)^2Q_1^2(\mathcal{R}_0(1 + \Psi_3)) \tag{3.16}
\end{aligned}$$

The constant term in the cubic polynomial (3.15) is  $\mathcal{G}_0$ , which is expressed in terms of  $\mathcal{R}_0$  is given in (3.16). The existence, and number of endemic equilibria for the model system (3.3) is determined by the existence of, and number of positive roots of the cubic equation (3.15). We investigate and characterise the solutions (roots) of the cubic poly-

nomial (3.15) by using the signs of its coefficients  $\mathcal{G}_3, \mathcal{G}_2, \mathcal{G}_1$ , and  $\mathcal{G}_0$ . Clearly  $\mathcal{G}_3 < 0$ . If  $\mathcal{R}_0 < 1$ , then  $\mathcal{G}_0 < 0$ . Also, if  $\mathcal{R}_0 > 1$ , then  $\mathcal{G}_0 > 0$ .

In order to determine whether the model (3.3) has a unique endemic equilibrium or multiple endemic equilibria when  $\mathcal{R}_0 > 1$ , we determine the turning points of the cubic equation (3.15). We do this by evaluating the first order derivative of  $\mathcal{H}(D^*)$  and equate it to zero. This gives

$$\mathcal{H}'(D^*) = 3\mathcal{G}_3(D^*)^2 + 2\mathcal{G}_2(D^*) + \mathcal{G}_1 = 0. \quad (3.17)$$

The turning points of equation (3.15) (using the quadratic formula to evaluate the roots of (3.17)) are given by

$$(D^*)_{1,2} = \frac{-\mathcal{G}_2 \pm \sqrt{\mathcal{G}_2^2 - 3\mathcal{G}_1\mathcal{G}_3}}{3\mathcal{G}_3}. \quad (3.18)$$

The discriminant of solutions (3.18) is  $\Delta = \mathcal{G}_2^2 - 3\mathcal{G}_1\mathcal{G}_3$ . We investigate the nature of the roots (3.18) by analysing possible signs of the discriminant  $\Delta$ . If  $\Delta < 0$ , then  $\mathcal{H}(D^*)$  has no real turning points, which implies that  $\mathcal{H}(D^*)$  is a strictly monotonic function. We investigate the monotonicity of  $\mathcal{H}(D^*)$  by examining the sign of  $\mathcal{H}'(D^*)$  into the sum of a square and a constant term. We obtain

$$\mathcal{H}'(D^*) = 3\mathcal{G}_3 \left[ \left( D^* + \frac{\mathcal{G}_2}{3\mathcal{G}_3} \right)^2 + \frac{1}{9\mathcal{G}_3^2} (3\mathcal{G}_1\mathcal{G}_3 - \mathcal{G}_2^2) \right]. \quad (3.19)$$

If  $\Delta < 0$ , then  $3\mathcal{G}_1\mathcal{G}_3 - \mathcal{G}_2^2 > 0$ . Since  $\mathcal{G}_3 < 0$ , then  $\mathcal{H}'(D^*) < 0$ . This implies that the polynomial function  $\mathcal{H}(D^*)$  in (3.15) is strictly monotone decreasing. Note that  $\mathcal{H}(0) = \mathcal{G}_0 > 0$  if  $\mathcal{R}_0 > 1$ . Hence,  $\mathcal{H}(D^*)$  has only one positive real root, and consequently only one endemic equilibrium.

If  $\Delta = 0$ , then  $\mathcal{H}'(D^*)$  has only one real root with multiplicity two. This implies that  $(D^*)_1 = (D^*)_2 = -\frac{\mathcal{G}_2}{3\mathcal{G}_3}$ .  $\Delta = 0$  implies that  $3\mathcal{G}_1\mathcal{G}_3 - \mathcal{G}_2^2 = 0$ , which also implies that  $\mathcal{H}'(D^*) < 0$ . This indicates that  $\mathcal{H}(D^*)$  is a decreasing function.  $\mathcal{H}'(D^*)$  has only one root which is  $-\frac{\mathcal{G}_2}{3\mathcal{G}_3}$ , and it has a multiplicity two. Given that,  $\mathcal{H}''(D^*) = 6\mathcal{G}_3D^* + 2\mathcal{G}_2$ , we observe that  $\mathcal{H}''(-\frac{\mathcal{G}_2}{3\mathcal{G}_3}) = 0$ . This means that the turning point  $(D^*)_1 = (D^*)_2 = -\frac{\mathcal{G}_2}{3\mathcal{G}_3}$  is a point of inflexion for  $\mathcal{H}(D^*)$ . Since the only stationary point of  $\mathcal{H}(D^*)$  in this case is a point of inflexion,  $\mathcal{H}(0) = \mathcal{G}_0 > 0$  for  $\mathcal{R}_0 > 1$ , and  $\mathcal{H}(D^*)$  is a decreasing function, then,  $\mathcal{H}(D^*)$  has only one positive real root, and consequently only one endemic

equilibrium.

For  $\Delta > 0$ , we consider two cases;  $\mathcal{G}_1 < 0$  and  $\mathcal{G}_1 > 0$ . If  $\mathcal{G}_1 < 0$ , then  $\mathcal{G}_1\mathcal{G}_3 > 0$ . This means that  $\sqrt{\Delta} < \mathcal{G}_2$ . Irrespective of the sign of  $\mathcal{G}_2$ ,  $\mathcal{H}'(D^*)$  has two real positive and distinct roots. This implies that  $\mathcal{H}(D^*)$  has two positive turning points. Since  $\mathcal{H}(0) = \mathcal{G}_0 > 0$  for  $\mathcal{R}_0$ , then,  $\mathcal{H}(D^*)$  has at least one positive real root, and consequently at least one endemic equilibrium.

If  $\mathcal{G}_1 > 0$ , then  $\mathcal{G}_1\mathcal{G}_3 < 0$ , which implies that  $\sqrt{\Delta} < \mathcal{G}_2$ . For  $\mathcal{G}_2 > 0$ ,  $\mathcal{H}'(D^*)$  has two real roots of opposite signs. Since  $\mathcal{H}(0) = \mathcal{G}_0 > 0$  for  $\mathcal{R}_0 > 1$ , then,  $\mathcal{H}(D^*)$  has one positive root. For  $\mathcal{G}_2 < 0$ ,  $\mathcal{H}'(D^*)$  has two negative real roots. Since  $\mathcal{H}(0) = \mathcal{G}_0 > 0$  for  $\mathcal{R}_0 > 1$ , then  $\mathcal{H}(D^*)$  has only one positive real root, and consequently only one endemic equilibrium.

Furthermore, we use the *Descartes' Rule of Signs* [15] to explore the existence of endemic equilibrium (or equilibria) for  $\mathcal{R}_0 < 1$ . When  $\mathcal{R}_0 < 1$ , we have  $\mathcal{G}_3 < 0$  and  $\mathcal{G}_0 > 0$ . If  $\mathcal{G}_2 > 0$  and  $\mathcal{G}_1 < 0$ ,

$$\mathcal{H}(D^*) = -\mathcal{G}_3D^3 + \mathcal{G}_2D^2 - \mathcal{G}_1D - \mathcal{G}_0 = 0. \quad (3.20)$$

There are only two sign change in equation (3.20), which implies that (3.20) can only have two positive roots. This means that equation (3.15) has two endemic equilibria.

If  $\mathcal{G}_2 > 0$  and  $\mathcal{G}_1 > 0$ , then, equation (3.15) can be expressed as

$$\mathcal{H}(D^*) = -\mathcal{G}_3D^3 + \mathcal{G}_2D^2 + \mathcal{G}_1D - \mathcal{G}_0 = 0. \quad (3.21)$$

There are only two sign changes in equation (3.21), which implies that (3.21) has two positive roots. This means that equation (3.15) has two endemic equilibria.

If  $\mathcal{G}_2 < 0$  and  $\mathcal{G}_1 < 0$ , then, equation (3.15) can be expressed as

$$\mathcal{H}(D^*) = -\mathcal{G}_3D^3 - \mathcal{G}_2D^2 - \mathcal{G}_1D - \mathcal{G}_0 = 0. \quad (3.22)$$

There are no sign changes in (3.22), which implies that (3.22) will have no positive root.



If  $\mathcal{G}_2 < 0$  and  $\mathcal{G}_1 > 0$ , then, equation (3.15) can be expressed as

$$\mathcal{H}(D^*) = -\mathcal{G}_3 D^3 - \mathcal{G}_2 D^2 + \mathcal{G}_1 D - \mathcal{G}_0 = 0. \quad (3.23)$$

There are two sign changes in (3.23), which implies that (3.23) has two positive roots. This means that equation (3.15) has two endemic equilibria.

The theorem below summarises the existence of endemic equilibria of the model system (3.3).

**Theorem 3.2.3.** *The model system (3.3)*

- (i) *has a unique endemic steady state when  $\mathcal{R}_0 > 1$ .*
- (ii) *has two endemic equilibria for  $\mathcal{R}_0 < 1$ , but in the range  $\mathcal{R}_0^c < \mathcal{R}_0 < 1$ .*
- (iii) *has no other equilibria.*

**Remark 3.2.1.** *The existence of two endemic equilibria suggests the existence of a backward bifurcation. So the existence of the threshold  $\mathcal{R}_0^c$  is assumed as a result.*

### 3.3 Sensitivity analysis

Mckay [40] described sensitivity analysis as the study of how the uncertainty in the output of a model can be allocated to different sources of uncertainty in the model output. By systematically changing parameters in the model to determine the effects of changes, results of sensitivity analysis facilitate model development, verification and validation [70]. We use the Latin Hypercube Sampling (LHS) scheme to perform the sensitivity analysis of model parameters to the model output. An advantage of the LHS method appears when the output is dominated by only a few of the components of parameter space. This method guarantees that each of those components is presented in a fully stratified manner, independent of which components turn out to be important [40]. LHS ameliorate the random sampling when certain monotonicity conditions hold. It is also a desired method to use for selecting values of input variables [70]. Statistical independence is assumed, and a 1000 simulations are done per run. First, we compute the Partial Rank Correlation Coefficients (PRCC) for each parameter value, sampled by the

LHS scheme, and the outcome values of the reproduction number  $\mathcal{R}_0$  are derived from uncertainty analysis [27]. The LHS technique is used with the hope of building confidence in the model by investigating the uncertainty associated with the parameters in the model. We examine the sensitivity of the reproduction number  $\mathcal{R}_0$  to variation in parameters:  $\sigma, \rho_1, \gamma_2, \alpha_2$  and  $\rho_2$ .

### 3.3.1 Parameter estimation

In this subsection, we estimate the parameters used in the sensitivity analysis for the syndemic model. Most of the parameters are obtained from SACENDU, Crime Stats SA, Census South Africa and SA health that collected their data from the Western Province of South Africa [3, 58, 63, 67]. South Africa's life expectancy has been changing over the years. For example in 2005 it was 53.5 years, and in 2013 it was 62 years [58]. On average, the life expectancy in South Africa for the past 5 years has been approximately 56.01 years. Thus, if we assume that drug use starts at an estimated age of 16, the natural mortality rate for the individuals in the system will be  $\mu = 0.025$ . The population of the Western Cape has been remarkable, and the increasing population trend can be attributed to labour migration. It is a custom in South Africa for people to leave their provinces or usual residences in search of work in the more industrialised provinces like the Western Cape [44]. Therefore, the recruitment rate for the model accounts for both the average birth rate and immigration into the Western Cape, where  $\Pi = 0.03$  [70]. The effective contact rate between the susceptible population and drug users and drug-related criminals is estimated at  $\beta = 0.45$ , and the innovation parameter is assumed to be  $\eta = 0.25$ . The mean rate at which users quit and become susceptible again is assumed to be  $\alpha_1 = 0.28$ . The uptake into rehabilitation, relapse and successful rehabilitation rates are based on the average percentages of first time admissions in SACENDU's reports for 2004 – 2014 and are respectively,  $\gamma_1 = 0.04$ ,  $\gamma_2 = 0.257$  and  $\alpha_2 = 0.7$  [18, 62, 63]. The successful conviction rate  $\sigma$  is estimated according to the research on conviction rates of all crime categories by Leggett [69], which are based on the Law Commission report on conviction rates and other outcomes of crimes reported in eight South African police areas [10]. It is indicated in the report that 25% of cases that make it to the court, only a quarter produce convictions within the period of investigation [10, 69]. Hence, the mean rate at which those in drug-related crime are successfully sentenced to correctional services is set at  $\sigma = 0.125$ . The rate of correctional service

referral to rehabilitation is estimated at  $\rho_1 = 0.125$  [18, 62, 63]. Finally, the deaths occurring within the  $D$  are assumed to be higher than those of the susceptible population in  $C$ . Therefore, term  $\delta$  term is added to the removal of individuals due to drugs and crime, where  $\delta = 0.04$ .

Table 3.2. Parameter values used in sensitivity analysis.

Parameter	Range	Nominal value	Reference
$\Pi$	-	0.03	[70]
$\mu$	-	0.05	[58]
$\beta$	-	0.45	Estimated
$\eta$	-	0.25	Estimated
$\alpha_1$	-	0.28	Estimated
$\alpha_2$	0.2 – 0.8	0.7	[18, 62, 63] <sup>1</sup>
$\gamma_1$	-	0.04	[18, 62, 63] <sup>2</sup>
$\gamma_2$	0.15 – 0.3	0.257	[18, 62, 63] <sup>3</sup>
$\sigma$	0.01 – 0.2	0.125	[69] <sup>4</sup>
$\rho_1$	0.02 – 0.08	0.125	[18, 62, 63] <sup>5</sup>
$\rho_2$	0.15 – 0.22	0.179	[45] <sup>6</sup>
$\delta$		0.04	Estimated

### 3.3.2 Results of our analysis

The tornado plot, Figure 3.2 show the PRCC of the parameters  $\sigma, \rho_1, \gamma_2, \alpha_2$  and  $\rho_2$  respective to  $\mathcal{R}_0$ . Successful conviction rate  $\sigma$  has a notably greater potential to reduce the epidemic when it is increased.

Figure 3.3 illustrates the Monte Carlo simulations for the five parameters whose PRCC magnitudes are shown in Figure 3.2. We observe from Figure 3.3 that  $\gamma_2$  has weak positive correlation with the  $\mathcal{R}_0$ , indicating the potential of increasing in substance abuse and drug-related crime compartment ( $D$ ). We notice that  $\sigma$  shows strong negative correlation, and thus has a significant potential of decreasing the epidemic when it is increased. It is observed that successful conviction rate  $\sigma$ , has a much stronger influence

<sup>1</sup>Estimated on average of 2004 – 2014 first time admissions

<sup>2</sup>Estimated on the average growth of uptake into rehabilitation for 2004 – 2014

<sup>3</sup>Estimated on average of 2004 – 2014 first time admissions

<sup>4</sup>Estimated rate based on all crime categories

<sup>5</sup>Estimated on average of 2004 – 2014

<sup>6</sup>Estimated on average duration of offenders in correctional service

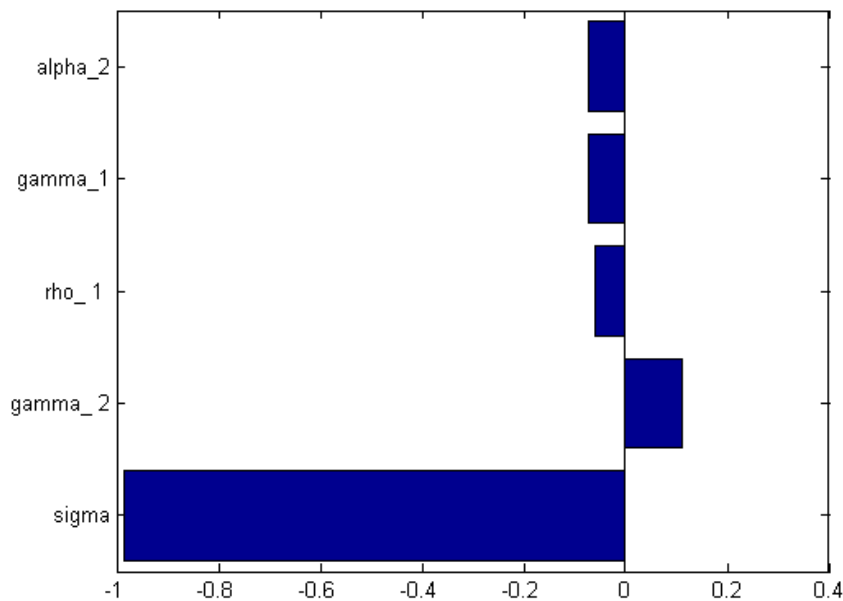

Figure 3.2. PRCCs for the parameters of interest with respect to  $\mathcal{R}_0$  from Table 3.2

in the model than correctional service referral to rehabilitation, successful rehabilitation or successful corrections. In Figure 3.3, graph (f) the box-plot show the range of  $\mathcal{R}_0$  for the selected set of parameters. We note that the median is slightly greater than one, indication that the endemic exists.

## Conclusion

In this Chapter, a deterministic model demonstrating the dynamics of the substance abuse and drug-related crime syndemic in the Western Cape is presented. When one uses non-linear ordinary differential equations, there is always a trade off between how many elements one can include in the model to represent the 'real life' reasons, and having a model too complex to analyze. In the hope to bypass this trade off, we include a systemic approach to this study. By using systems thinking and system dynamics, we can expand the deterministic model, and still be able to analyse it by using a platform like STELLA. In Chapter 4 we endeavour to construct a system dynamics model. Finally in Chapter 5 a discussion on the comparison of the model presented in

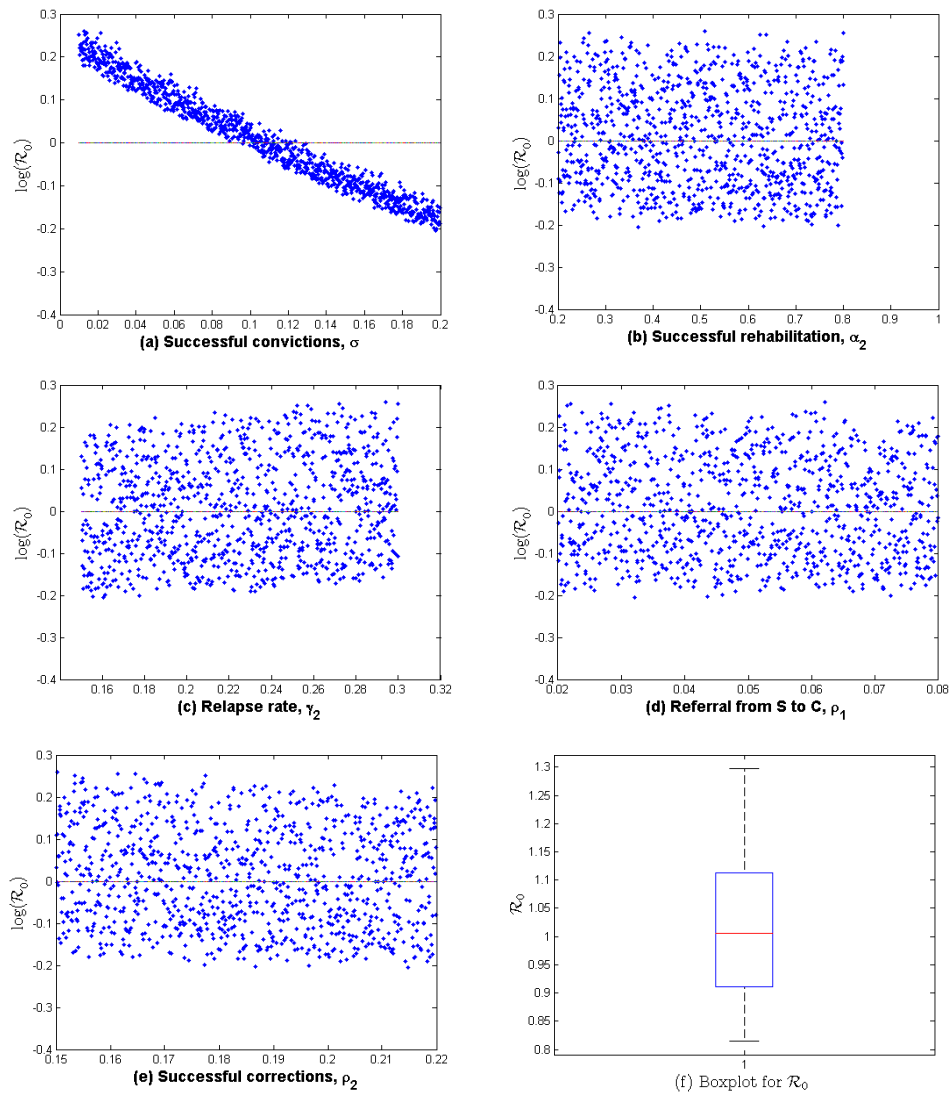

Figure 3.3. Cases (a), (b), (c), (d) and (e) show the Monte Carlo simulations for the five parameters influencing  $\mathcal{R}_0$ , namely  $\sigma$ ,  $\rho_1$ ,  $\gamma_2$ ,  $\alpha_2$  and  $\rho_2$ . Case (f) is a box plot depicting the different values for  $\mathcal{R}_0$  according to the varying variables.

---

this Chapter and the model following in Chapter 4 is given, recalling observations of the simulations, mentioning model limitations, finally concluding with suggestions for model extensions and suggestions for future work.

# Chapter 4

## A system dynamics model

### 4.1 Model building

Systems thinking and System Dynamics enable us to develop models to promote our understanding about how entities, regarded as systems, interact and influence each other as a structured functional unit. Systems are thus characterized by dynamic relationships between the inter-dependent components. In this study we look at systems thinking in the context of substance abuse and drug-related crime in South Africa. Substance abuse is a major problem in South Africa and is often associated with increased crime and the spread of sexually transmitted diseases. The fight against substance abuse has been driven by a multi-sectorial approach involving several government departments, communities and non-governmental organisations. We view these as elements whose interconnections are driven by the flow of information and individuals. These flows hold the elements/systems together and play a critical role in how the systems operate to achieve the common goal of containing substance abuse and related social ills. The intent of this study is to provoke critical thinking about the possibilities systems thinking holds as a research tool, exploring new areas and connecting ones that are already well known and established, with the hope to encourage collective thinking and integration of various elements that collectively work to curb the scourge of substance abuse.

### 4.1.1 Model boundaries

This model is based on the premised idea that a community is an interacting set of systems that support or buffer the occurrence of certain dynamics, such as substance abuse and drug-related crime. The systemic approach to the model firstly enables us to create a system model that can capture the primary community structures and relationships (stocks and flows) that sustain the substance-abuse and drug-related crime within the community, and secondly allow us to critically test plausible strategies to reduce or counteract these problems.

The model is derived from empirical evidence from the literature since the research available concerning key stocks and flows in this model is limited and there are few published studies on the topic available, especially with regards to the area of the Western Cape. We also make some informed assumptions based on what is currently known. In this study the system constructed is not a single organizational entity, but rather an integrated and interacting community response to substance abuse and drug-related crime, through considering the rehabilitation processes of both cases. As Chandler et al [9] explained, focusing on treatment of drug-involved offenders offers the opportunity to decrease and reduce substance abuse and drug-related criminal behaviour respectively.

A systems dynamics based computer simulation model is constructed, and is named the Substance abuse and drug-related crime in the Western Cape (SADC-WC) model, for the estimation and prediction of connections between substance abuse and drug-related crime within communities in the Western Cape. The boundary of this model is the total area of the Western Cape province which constitutes of one metropolitan municipality, namely the City of Cape Town, and five district municipalities, namely Cape Winelands, Central Karoo, Eden, Overberg and West Coast. The five district municipalities beset 24 local municipalities. Within the geographical boundaries there are 150 police precincts, 60 precincts are classified as urban because they fall within the Cape Metropolitan area and 90 police precincts are classified as rural as they fall outside the city of Cape Town [44]. The model boundaries include 32 specialist treatment centres/programs that participate in the SACENDU project in the Western Cape [18, 19].

We expect that the SADC-WC system, as in the case with most other health systems, exhibits the following characteristics: Self-organizing, constantly changing, tightly-linked,



governed by feedback, non-linear, history dependant, counter-intuitive and resistant to change [2].

### 4.1.2 Stocks and flows

The SADC-WC system is constituted of the stocks and flows listed in Table 4.1.2. The broader susceptible community (individuals at risk) of the WC represents the  $C$  stock. The individuals that are abusing any form of substance or take part in any form of drug-related crime (possession, trading, use or motivation for crime) are in  $U$ . Even though the responsibility of safety is webbed within the community between different stake holders, the South African Police Services (SAPS) are held responsible through the South African constitution as stated in Section 20 (3) to prevent, combat and investigate crime. Therefore the police enforcement is a stakeholder within our system, which is represented by drug-related crime cases made by the SAPS as  $L$ . In this paper the levels of functionality of SAPS is measured by the changes = the number of cases recorded annually. All the cases that are successfully convicted are represented by the Correctional Service stock  $S$ . The specialist treatment and rehabilitation centres are depicted as  $R$ , the stock for individuals that are undergoing rehabilitation, whether by own accord or through the recommendation of correctional services.

### 4.1.3 Sources of information for the flows

The community is governed by an inflow that is dependent on births and nett migration and a outflow dependent on deaths. Initiation of individuals within the community at risk into drug use and drug-related crime is caused when individuals from  $C$  and  $D$  interact, self conviction for early substance users or drug-related crime are allowed and governed by the self-efficacy of the individual. The White and Gorman [14] models of the complex relationship of drugs and crime is the motivation behind the flows that increase and decrease the substance abuse and drug-related crime stock  $U$ , as well as keeping the two in one stock. Since this study is focused on the syndemic between substance abuse and drug-related crime, White and Gorman's models where substance use leads to crime, and secondly crime leads to substance use are included. The third model where the relationship is either coincidental or explained by a set of common

Table 4.1. Stocks and Flows of the SADC-WC system, where the cloud symbol ( $\textcircled{\infty}$ ) refers to a source/pit in the system.

Flows	Movement	Variable	Stock
Initiation	$C \rightarrow D$	$C$	Community
Personal Conviction	$D \rightarrow C$	$D$	Drug-related Crime and Substance Abuse
Inflow	$\textcircled{\infty} \rightarrow C$	$R$	Rehabilitation
Outflow	$C \rightarrow \textcircled{\infty}$	$S$	Correctional Services
Uptake	$D \rightarrow R$	$L$	Law Enforcement
Relapse	$R \rightarrow D$		
Cases	$\textcircled{\infty} \rightarrow L$		
Convictions	$L \rightarrow S$		
Successful Convictions	$L \rightarrow S$		
Failed Convictions	$L \rightarrow U$		
Correctional Rehabilitation	$S \rightarrow R$		
Completed Sentences	$S \rightarrow C$		
Successful Rehabilitation	$R \rightarrow C$		
Drug and Crime-related Deaths	$D \rightarrow \textcircled{\infty}$		
Rehabilitation Deaths	$R \rightarrow \textcircled{\infty}$		
Correctional Service Deaths	$S \rightarrow \textcircled{\infty}$		

causes were not taken into account in this model, since it doesn't fall within the boundaries of this system. Most crimes reported by the SAPS do not make it to the court, and are represented within the failed convictions flow. The following reasons can be the cause for withdrawal of cases: Undetected, withdrawn by complainant, unfounded, ongoing investigation, ongoing investigation and warrant issued [10]. The flows influencing  $L$  are based on the progress and finalisation of cases as illustrated in Figure 4.1.3. The conviction flow feeding  $S$  is thus based on the successful conviction flow out of  $L$ . Individuals within  $S$  can be referred to  $R$  for rehabilitation, or complete their sentence time and move back into the community  $C$ .

Connectors exhibit how one variable causes another variable to change, indicating cause and effect within the system. The connectors (parameters) of the SADC-WC system are listed in Table 4.4. Data that is relevant to internal linkages within the system are gathered from the multiple data sources available as mentioned above to support the flows and conditions within and among the stocks in this system. The connectors that implicate the uptake of individuals into  $R$  were based on the data collected from SACENDU [18, 20]. The birth and death rate values are supported by the census data of 2004 and 2011 [66, 67]. Relapse and successful rehabilitation rates are supported by the propor-

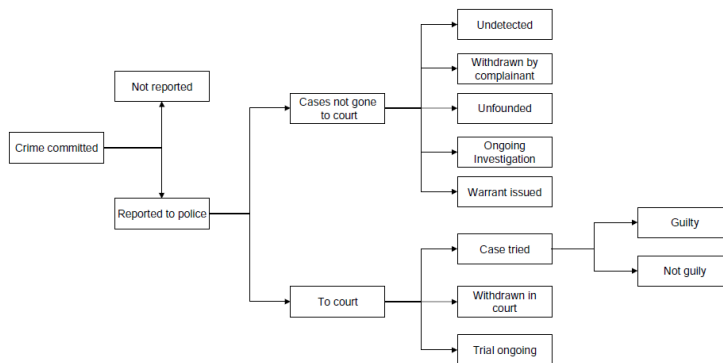

Figure 4.1. Progress and finalisation of cases. The main outcomes of crimes as indicated by the point in the criminal justice system where it is pending or closed. (SAPS classification system) [10]

tion of first time patients admitted to rehabilitations in the latest reports of SACENDU for the Western Cape rehabilitation centres [18, 20]. The arrest and conviction rates are based on information obtained from the SAPS and Crime Stats SA [3, 64]. If the police are able to gather sufficient evidence linking suspect to a crime, they will arrest and charge this individual which is referred to as the arrest ratio. All other connector values were assumed based on the model by iteratively simulating the model.

The national offender population profile for 2007 was published in the 2007 annual report of the Department of Correctional Services. The total number of sentenced offenders was 113213 with 97,82% males and 2,18% females. In terms of crime categories offenders incarcerated for economical crimes were 24362, for aggressive crimes were 64459, for sexual crimes were 17776, for drug-related crimes were 2418 and for other crimes were 6521. In terms of the length of sentences, 42% of offenders are serving sentences of more than 5 to 15 years followed by sentences of more than a month to five years at 31%, more than 15 to 20 years at 10% and 20 years and longer at 9%. Offenders serving life sentences constituted 7% [45]. The Western Cape accounted for 47% of the national drug related crime in 2010/11, 44% in 2011/12 and 40% in 2012/13 [44].

## 4.2 Model analysis

### 4.2.1 Casual loop diagram

A causal loop diagram is an illustration of how the stocks are linked with flows, indicating the sources of information within a system. Figure 4.2 illustrates the causal loop diagram for the theoretical model of the SADC-WC system, indicating the amplifying and balancing loops. Both positive and negative feedback loops are present and govern the SADC-WC system as seen the casual loop diagram in Figure 4.2, indicating that exponential growth and exponential approach can be expected within the simulations for the loops respectively. In this illustration a positive casual link indicates a change in the same direction within the stocks and a negative casual link indicates a change in opposite directions for the stocks. Both amplifying and balancing loops are found within this diagram as indicated with the “A” and “B” nodes.

### 4.2.2 Main feedback loops

A positive feedback loop is a self-reinforcing process that causes exponential growth. Feedback loops can be visualised and explained through causal loop diagrams. In a causal loop diagram the “+” sign next to an arrow indicate that as the one stock changes, the other stock changes in the same direction. The “+” sign within the circular arc in the feedback loop indicate positive feedback. It has to be noted that a “+” sign does not necessarily mean that the one stock causes the other stock to increase, but rather that it causes the other stock to change in the same direction. Positive feedback loops or reinforcing loops cause exponential growth within a system.

A “-” sign next to an arrow in a causal loop diagram indicates that the two stocks will change in different directions. For example an increase in one stock will cause that the other stock to decrease. Negative feedback is a process that adjusts a variable to a goal. In the causal loop diagram, this is described by a circular arc with a “-” sign in it. In various disciplines, this can be referred to as a homeostatic self-governing or goal-seeking process. Thus, there is a desired goal that the system gradually approaches. The

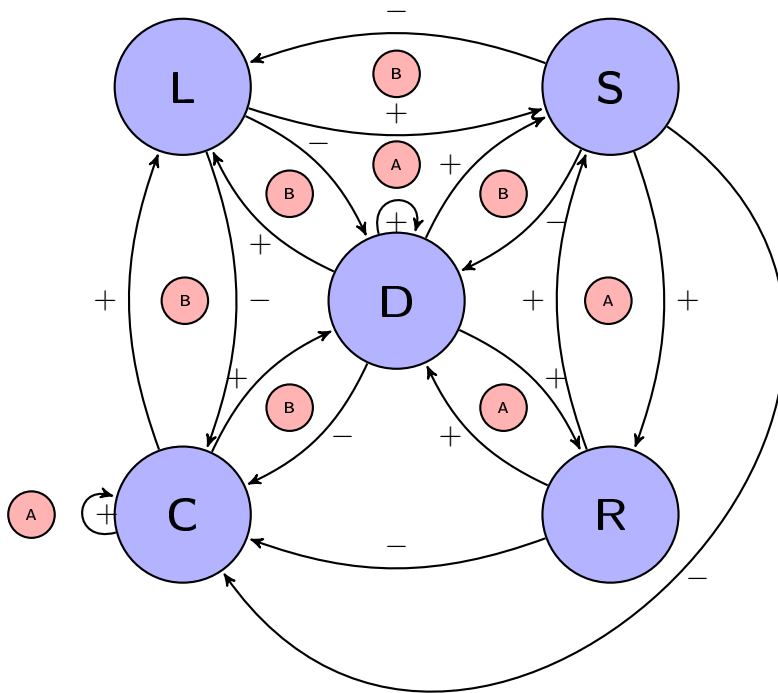

Figure 4.2. Causal loop diagram for the SADC-WC system.

system will change most when it is far from the goal, and least when it is close to the goal. This is referred to as exponential approach or a balancing loop.

### 4.2.3 Model diagram

Figure 4.3 depicts the stocks and flows used to construct the SADC-WC system, which are the basic infrastructure for the system. In Figure 4.4, the complete map of the SADC-WC system is illustrated, including all the converters and connectors that govern the flows in the system.

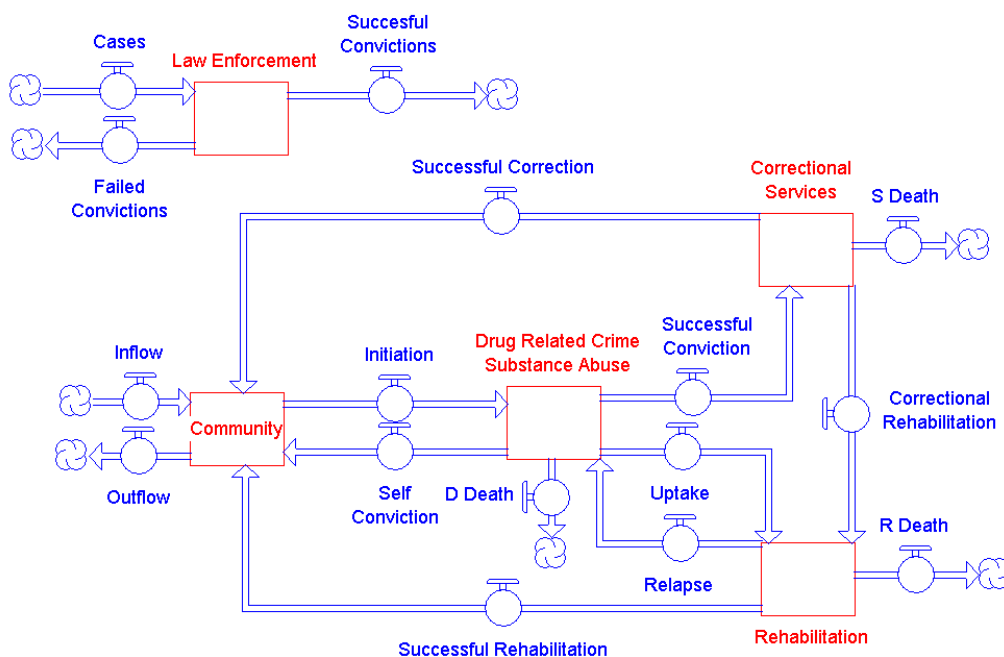

Figure 4.3. Map of the SADC-WC system in STELLA without any converters.

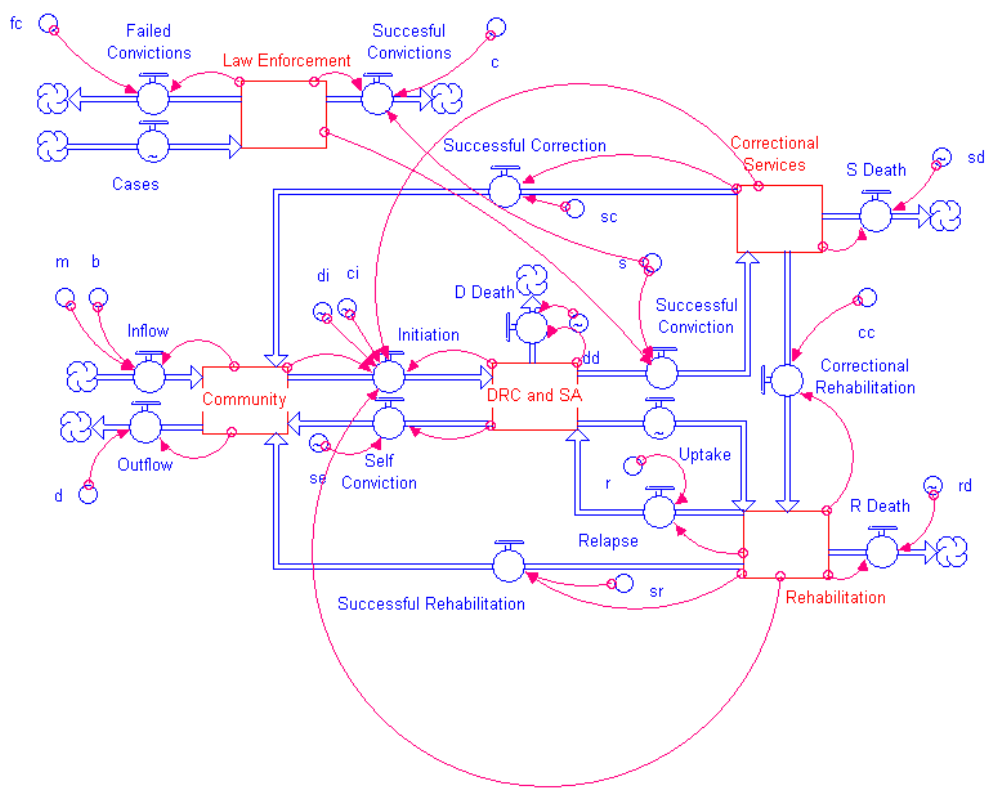

Figure 4.4. Map of the SADC-WC system in STELLA with converters.

## 4.3 Simulation of the model

### 4.3.1 Equations that determine the flows

Converters are used to either hold a constant value, or to apply an equation and convert a set of inputs into an output. Thus converters are the flows which if not constant are mathematical equations that link the stocks to each other. All the converters in the SADC-WC model are listed in Table 4.2, and all the information on the STELLA model is available in Appendix A.1.

Converter	Equation
Initiation	$C * D * di + C * D * ci$
Self conviction	$D * se$
Inflow	$C * b + m$
Outflow	$C * d$
Uptake	Fixed data set
Relapse	$R * r$
Cases	Fixed data set
Convictions	$L * c$
Successful convictions	$L * c$
Failed convictions	$L * fc$
Correctional rehabilitation	$R * cc$
Sentences completed	$C * sc$
Successful rehabilitation	$R * sr$
Drug and drug-related crime death	$D * dd$
Correctional service death	$S * sd$
Rehabilitation death	$R * rd$

Table 4.2. Converters and equations for the SADC-WC system, the parameters descriptions and values are given in Table 4.4



The SADC-WC stocks are governed by the following differential equations,

$$\frac{dC}{dt} = \text{Inflow} + \text{Successful rehabilitation} + \text{Successful corrections} + \text{Self conviction} \\ - \text{Outflow} - \text{Initiation}$$

$$\frac{dD}{dt} = \text{Initiation} + \text{Relapse} - \text{Uptake} - \text{Successful conviction} - \text{Self conviction} \\ - \text{Drug and crime related death}$$

$$\frac{dS}{dt} = \text{Successful conviction} - \text{Correctional rehabilitation} - \text{Successful correction} \\ - \text{Correctional service related death}$$

$$\frac{dR}{dt} = \text{Uptake} + \text{Correctional rehabilitation} - \text{Successful rehabilitation} - \text{Relapse} \\ - \text{Rehabilitaion related death}$$

$$\frac{dL}{dt} = \text{Cases} - \text{Failed convictions} - \text{Successful convictions}$$

### 4.3.2 Initial conditions and parameter estimation

The initial values for the Community, Drug-related crime and Rehabilitation stocks were derived from the data sources in [3, 19, 66, 67]. The drug-related crime for the WC were recorded as 30432 cases [65], thus the initial number of drug-related crime cases  $L(0) = 30432$  in 2004. According to the SACENDU's report [19], 4563 patients were treated in 2004 in rehabilitation centres in the WC, so we take  $R(0) = 4563$ . The total estimated population for the WC in 2004 was 4645600 [5]. According to Health 24 the substance abusing population can be estimated at 15% of the total population [1], thus we take  $U_0 = 696840$ . The initial value of  $S(0)$  was estimated based on the conviction rate and the initial value for  $L$  [65, 69].

STATE VARIABLE	INITIAL VALUE	REFERENCE	CALCULATIONS
$L_0$	30432	[65]	-
$R_0$	4563	[19]	-
$C_0$	4645600	[5]	-
$D_0$	696840	[1]	Estimated as 15% of $D$
$S_0$	1902	[65, 69]	Estimated as $S(0) = D * 0.25 * .25$

Table 4.3. Initial values for the SADC-WC system.

STELLA model parameters as constant values in converters. The parameters used within the SADC-WC system are given in Table 4.4. The values are either gathered from data sources as cited, or in the instances where data was not available assumptions were made according to the known dynamics of the model. Assumed parameters were modified iteratively till resulting changes in the behaviour of the system are aligned with expectations of the model simulations which were guided by data available. This form of hit and miss is necessary in areas where extensive research on a particular dynamic process has not been done.

The birth and death rates for the system are based on the average values for South Africa during the 2004 – 2014 period [4]. The increasing population trends can be attributed to labour migration, it is custom in South Africa for people to leave their provinces or usual residences in search of work in the more industrialised provinces like the Western Cape [44]. The movement of people in South Africa due to labour migration motivated the addition of migration into the model. The estimated WC migration streams for 2004 – 2014 averaged on a net migration of 152230 people, we therefore assume an average inflow of 152230 individuals (assumed at risk) into the SADC-WC system annually. The relapse ratio and successful rehabilitation values are based on the average percentages of first time admissions in SACENDU's reports for the ten year period [18, 62, 63]. Correctional service referral to  $R$ , namely  $cc$  is estimated as an average for the 2004 – 2014 period [18, 62, 63]. The cases making it to court, cases not making court and successful conviction rates  $c$ ,  $fc$  and  $s$  respectively are estimated according to the research on conviction rates of all crime categories by Leggett [69], which are based on the Law Commission report on conviction rates and other outcomes of crimes reported in eight South African police areas [10]. It is indicated in the report that of the 25% of cases that make it to the court, only a quarter produce convictions within the period of investigation [10, 69]. The uptake rate  $u$ , of individuals into  $R$  is based on the percentage of growth of  $R$  for the 2004 – 2014 period [20]. Successful corrections are estimated as a function  $\tau$ , which is dependant on the average duration of offenders in  $S$  that are sentenced as mentioned in the Subsection 4.1.3. According to the Department of Correctional Services 31% of offenders are sentenced for 1 month to 5 years, 42% for 5 to 15 years, 10% for 15 to 20 years and 16% for 20 years and longer [45]. According to these findings the median of the respective times spent in  $S$  were used to determine the flow

of successful corrections, where

$$sc = \frac{1}{2.5} * 0.31 + \frac{1}{10} * 0.42 + \frac{1}{12.5} * 0.1 + \frac{1}{30} * 0.16 = 0.179.$$

The drug and crime initiation and self conviction values are estimated to be in the range of 0.01 – 0.05. Finally, the deaths occurring within the  $D, R$  and  $S$  stocks are assumed to be higher than those of the susceptible population in  $R$ , therefore in the range of 0.015 – 0.02.

PARAMETER DESCRIPTION	SYMBOL	VALUE	REFERENCE
Birth rate	$b$	0.023	[4] <sup>1</sup>
Death rate	$d$	0.013	[4] <sup>1</sup>
Relapse rate	$r$	0.257	[18, 62, 63] <sup>2</sup>
Correctional rehabilitation	$cc$	0.057	[18, 62, 63] <sup>3</sup>
Successful conviction rate	$s$	0.250	[69] <sup>4</sup>
Cases making court	$c$	0.250	[69] <sup>4</sup>
Cases not making court	$fc$	0.750	[69] <sup>4</sup>
Successful rehabilitation	$sr$	0.7	[18, 62, 63] <sup>5</sup>
Nett migration	$m$	152230	[4] <sup>6</sup>
Drug initiation rate	$di$	0.05 – 0.1	Estimated
Crime initiation rate	$ci$	0.05 – 0.1	Estimated
Self conviction rate	$se$	0.05 – 0.1	Estimated
Successful corrections	$sc$	0.179	[45] <sup>7</sup>
Drug and crime related death	$dd$	0.015 – 0.02	Estimated
Rehabilitation related death	$rd$	0.015 – 0.02	Estimated
Correctional service related death	$sd$	0.015 – 0.02	Estimated

Table 4.4. Parameters for the SADC-WC system.

<sup>1</sup>Estimated on average of 2004 – 2014 for SA

<sup>2</sup>Estimated on average of 2004 – 2014 first time admissions

<sup>3</sup>Estimated on average of 2004 – 2014

<sup>4</sup>Estimated percentage based on all crime categories

<sup>5</sup>Estimated on average of 2004 – 2014 first time admissions

<sup>6</sup>Estimated on average nett annual migration of the Western Cape for 2004 – 2014

<sup>7</sup>Estimated on average duration of offenders in correctional service

### 4.3.3 Results

#### SADC-WC system simulations

The simulations of the SADC-WC system's stocks and flows for 2004 – 2014 are illustrated in Figure 4.5 and Figure 4.6, respectively. All the information on the STELLA model is available in Appendix A.1. An important feature of the SADC-WC system, is the inclusion of law enforcement as a stock. This enabled us to use the known data from the SAPS of drug-related cases made per year in the Western Cape. Therefore, we expect the successful conviction flow to depict the similar flows to those that are currently occurring in the Western Cape. Since the model is fitted to the data, we assume that the inflows and outflows of the law enforcement and correctional service are an adequate depiction of what is currently happening within the criminal justice system of the Western Cape as illustrated in Figure 4.1.3. The simulations of the inflows and outflows of the law enforcement stock are cumbersome, as seen in Figure 4.6, indicating how disproportional the successful convictions are with regards to the failed convictions. The law enforcement stock in Figure 4.5 indicates that the cases of drug-related crime are ten times more than the successful convicted cases. This highlights the failure of the criminal justice system to convert cases made into successful convictions, due to cases not making it to court, and the high numbers of failed convictions.

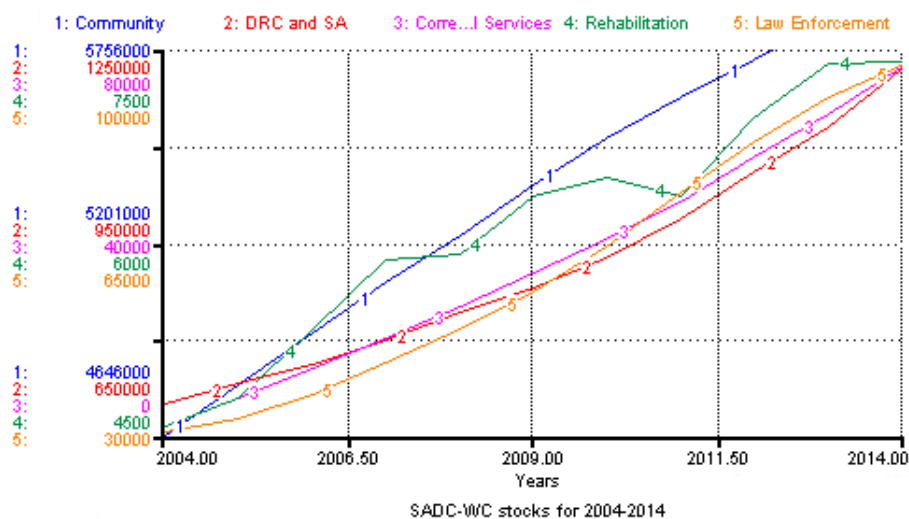

Figure 4.5. The stocks of the SADC-WC system for 2004 – 2014.

In Figure 4.5 we notice that the law enforcement, correctional service and drug abuse

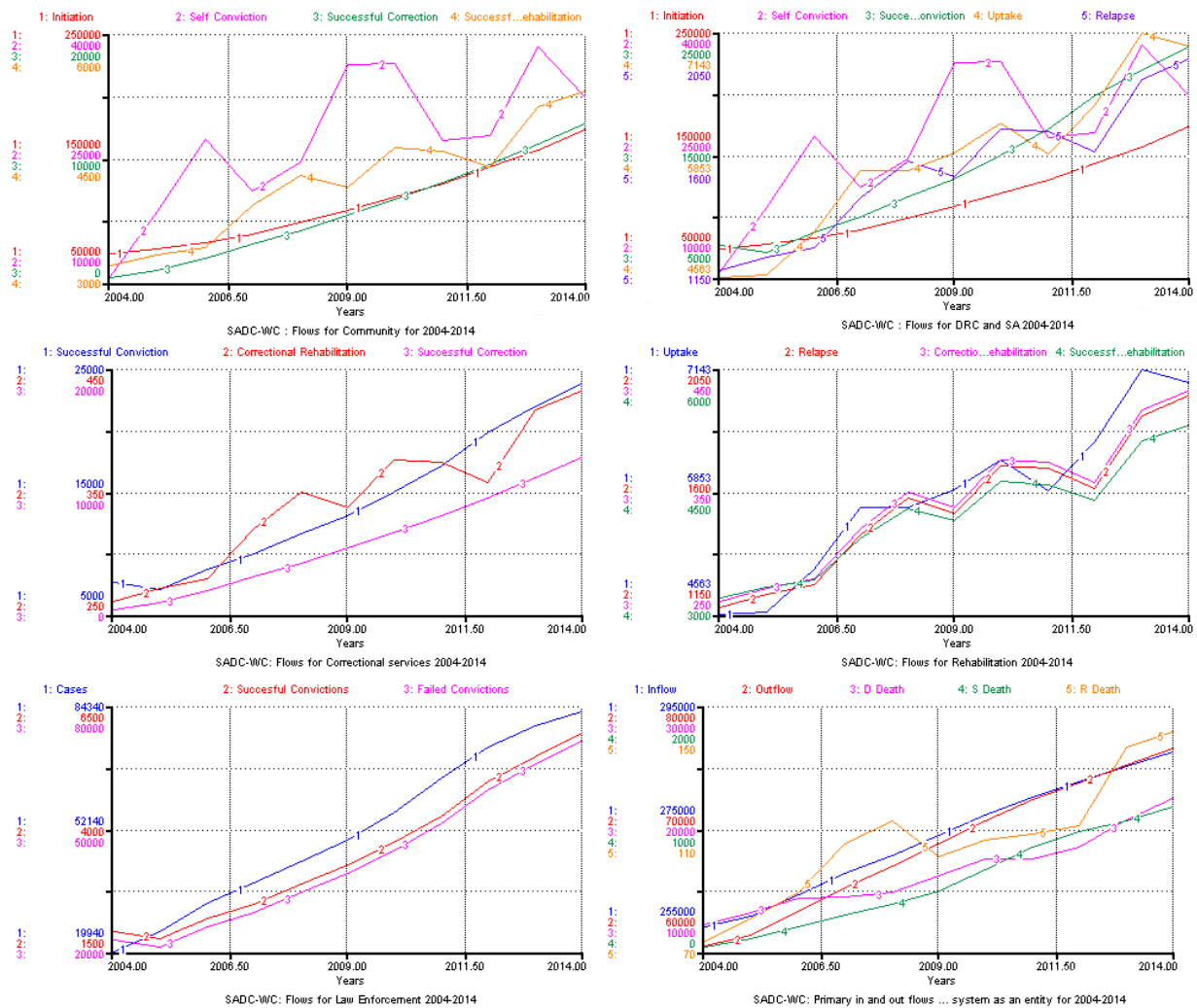

Figure 4.6. The flows of the SADC-WC system for 2004 – 2014.

and drug-related crime increased exponentially over the past decade. This correlates with the literature, as mentioned in Chapter 2. From Figure 4.5 we deduce that the substance abuse and drug-related crime are close to ten times more than the current cases that are reported by the law enforcement. This highlights the extent of the substance abuse and drug-related crime in the Western Cape.

Figure 4.6 illustrates the inflows and outflows for each stock in the SADC-WC system for the 2004 – 2014 period. The STELLA simulations enable us to compare the flows, which we are not able to do by just looking at the data we have from literature and sources as referenced in Chapter 1. We notice that the successful corrections inflow into

the community is significantly higher than the successful rehabilitations. Even though this could have been expected, since the correctional service stock is much larger than the rehabilitation stock, it also highlights the fact that a limited capacity of rehabilitation centres are a limit to the substance abuse → rehabilitation → community loop. We also notice that the successful convictions flow is significantly higher than the uptake flow into rehabilitation, again mirroring the restraint of limited space in rehabilitation centres in the Western Cape area. An unexpected observation in Figure 4.6, is how little the contribution of correctional service referrals to rehabilitation is. Finally, Figure 4.6 allows us to compare the deaths occurring in the Western Cape. We notice that the deaths due to drug abuse and drug-related crime is significantly high, this indicates the burden the syndemic has on communities.

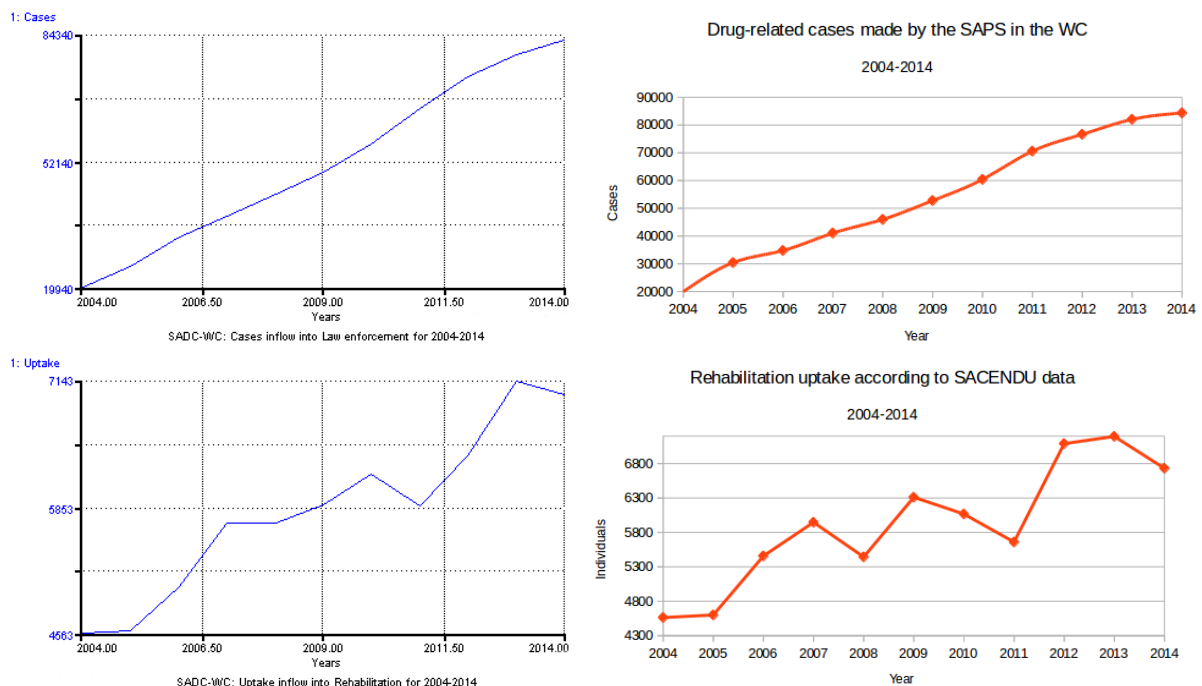

Figure 4.7. The SADC-WC system for 2004 – 2014 and comparable data for the period [20, 3].

As seen in Figure 4.7, the SADC-WC system model is well fitted to data from Crime statistics South Africa [3] and SACENDU [20], and should therefore represent an adequate representation of the successful convictions, failed convictions and relapse flows for the criminal justice system in the Western Cape, as seen in Figure 4.1.3.

### SADC-WC system projected simulations

The SADC-WC system is used to simulate what might be expected in the next ten years of the syndemic currently taking place in the Western Cape, if it persists as it currently is. All the information on the STELLA model is available in Appendix A.2. Thus, projected simulations are done for the period 2004 – 2024. It is assumed that the increase in uptake into rehabilitation will be similar to the average growth in uptake over the period of 2004 – 2014 [20]. It is assumed that drug-related crime cases will show similar growth as in the previous ten years according to data from the SAPS [65]. In Figure 4.8 the simulations for the different stocks and flows are shown.

From the projected simulations in Figure 4.8, we see that drug abuse and drug-related crime will double in the next ten years, if action is not taken to contain or reduce the syndemic. Similarly, it can be expected that the drug-related cases will double as well. Although, the rehabilitation stock only grew from  $\pm 7500$  to  $\pm 8500$ , highlighting the limited capacity of rehabilitation centres in the Western Cape. It is interesting that the projections indicate that the substance abuse and drug-related crime stock, as well as the correctional service stock, will grow exponentially in the next ten years. On the other hand, the law enforcement stock seem to show linear growth. The correctional service referrals to rehabilitation is still expected to be very low in the next ten years, according to the projections.

### Intervention 1: Effect of increased convictions

The effects of increasing cases going to court and successful convictions as an intervention are investigated. All the information on the STELLA model is available in Appendix A.3. The SADC-WC system is studied assuming that the cases making it to court and successful convictions will double over the next ten years. Both  $c$  and  $s$  are increased linearly over a period of ten years (2014-2024) from 0.25 to 0.5 to investigate how this will affect the system as a whole, and how it compares with the other interventions. In Figure 4.9 the simulations for the different stocks and flows are shown.

We notice that increase of cases going to court and successful conviction rate, has a significant impact on the syndemic. We see that drug-related crime cases made by the law enforcement flatten more towards 2024, whereas in Figure 4.8 we observe continuous

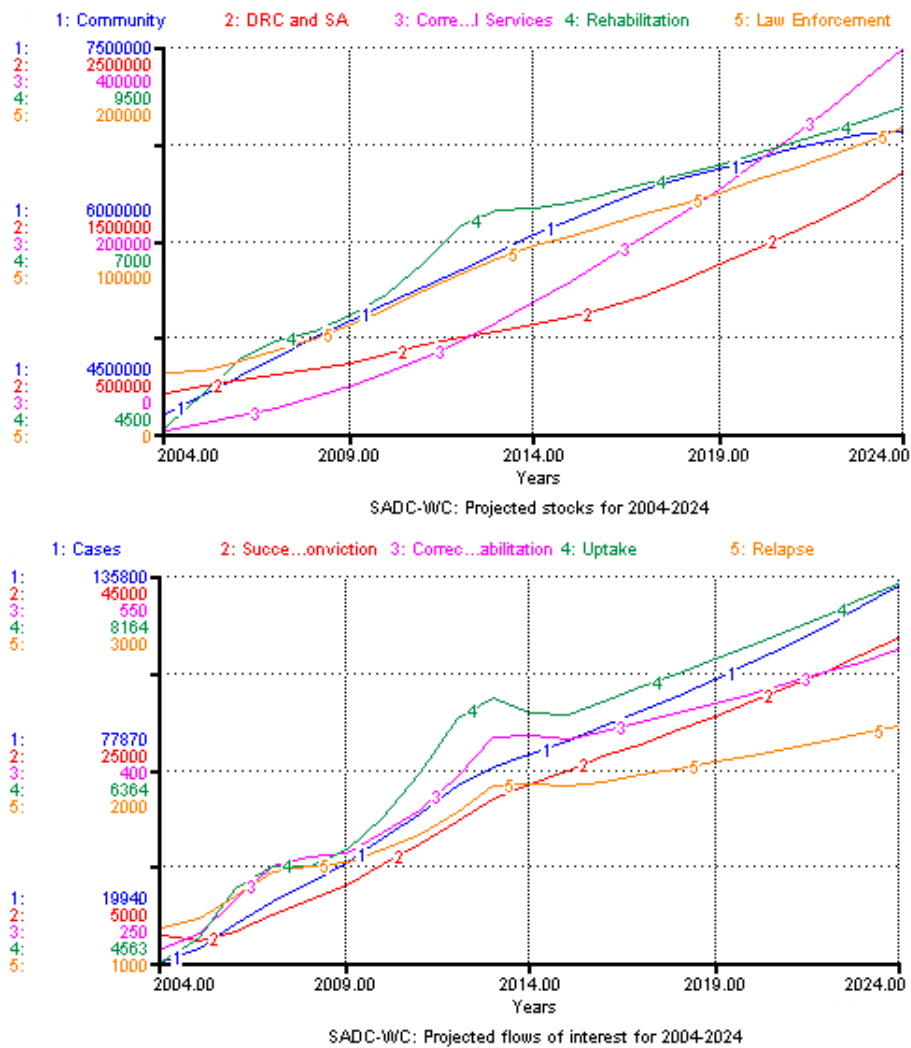

Figure 4.8. Projected stocks and flows for the SADC-WC system for 2004 – 2024.



linear growth of the law enforcement stock. This is due to the successful convictions inflow into correctional service, indicated to be over 6000 in 2024, as seen in Figure 4.9. In Figure 4.8, the system without any intervention, successful convictions inflows were closer to 4000. The complexity of the system is evident in the projected interventions. As we notice in Figure 4.9, even though successful convictions are increased, and cases of drug-related crimes level out in the future, it doesn't insure a lower stock of substance abuse in the future.

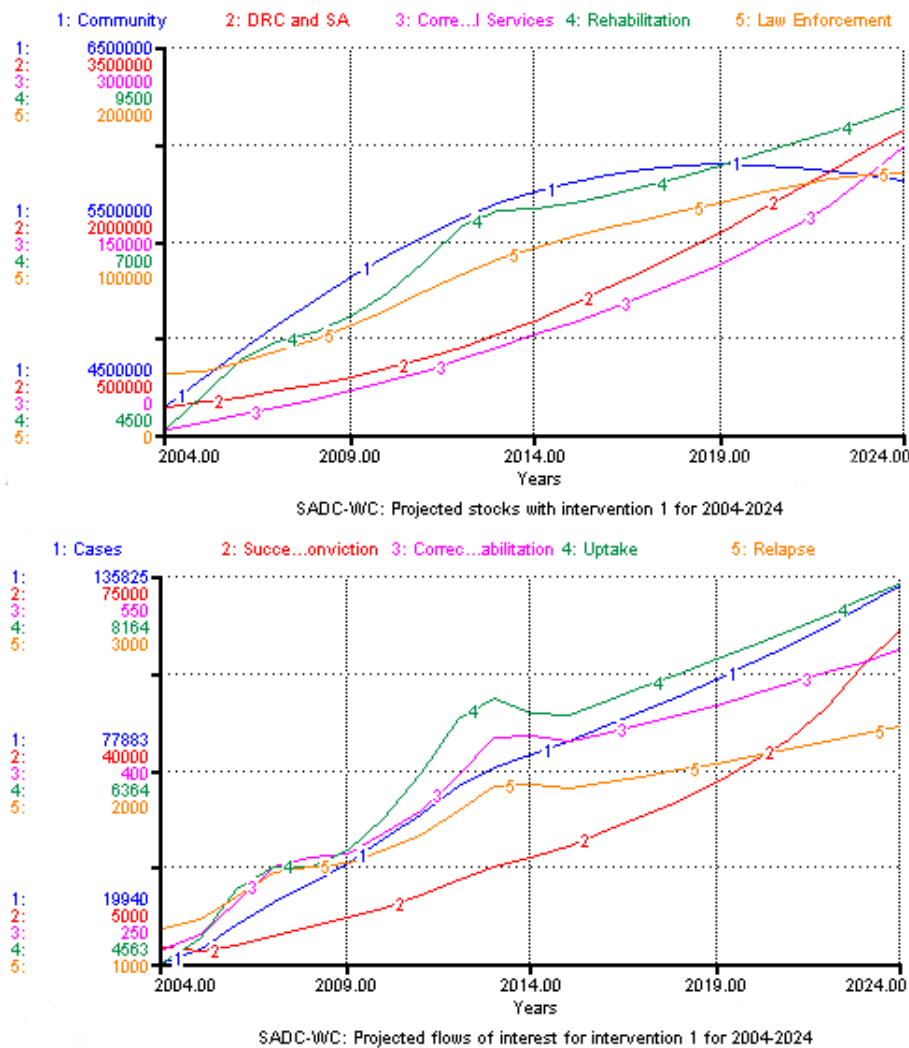

Figure 4.9. Projected stocks and flows for the SADC-WC system with increased convictions, intervention 1, for 2004 – 2024.

### **Intervention 2: Effect of increased correctional service referrals to rehabilitation centres**

The effect of increasing the rate at which correctional services refer individuals to rehabilitation centres as an intervention are investigated. All the information on the STELLA model is available in Appendix A.4. The SADC-WC system is studied assuming that the rate at which correctional services refer individuals to rehabilitation centres over the next ten years is doubled. Thus,  $cc$  is increased linearly over a period of ten years (2014-2024) from 0.05 to 0.10, to investigate how this will affect the system as a whole in comparison with the other interventions. In Figure 4.10 the simulations for the different stocks and flows are shown.

As indicated earlier the flow of referrals from correctional services to rehabilitation centres are very low currently in the Western Cape. We notice from the simulations in Figure 4.10, that even if the rate at which convicted criminals with a substance abuse addiction are referred to rehabilitation are doubled, it will not have a significant impact on the SADC-WC system as a whole. We note that the rehabilitation stock does not increase significantly in Figure 4.10, in comparison to Figure 4.8 where no intervention is exercised.

### **Intervention 3: The effect of reducing relapsing**

The effects of decreasing the percentage of individuals that relapse back into substance abuse and drug-related crime as an intervention are investigated. All the information on the STELLA model is available in Appendix A.5. The SADC-WC system is studied assuming that there will be a decrease in the percentage of individuals that relapse back into substance abuse and drug-related crime ( $D$ ) over the next ten years. This can be done for example by increasing the efficiency of rehabilitation programs or increasing the duration of rehabilitation programs. Thus,  $R$  is decreased linearly over a period of ten years (2014-2024) from 0.257 to 0.127 to investigate how this will affect the system as a whole, and how it compares with the other interventions. In Figures 4.11 the simulations for the different stocks and flows are shown.

As seen in Figure 4.11, the relapse inflow into drug abuse and drug-related crime fall drastically, but still the drug abuse and drug-related crime stock are very similar to those

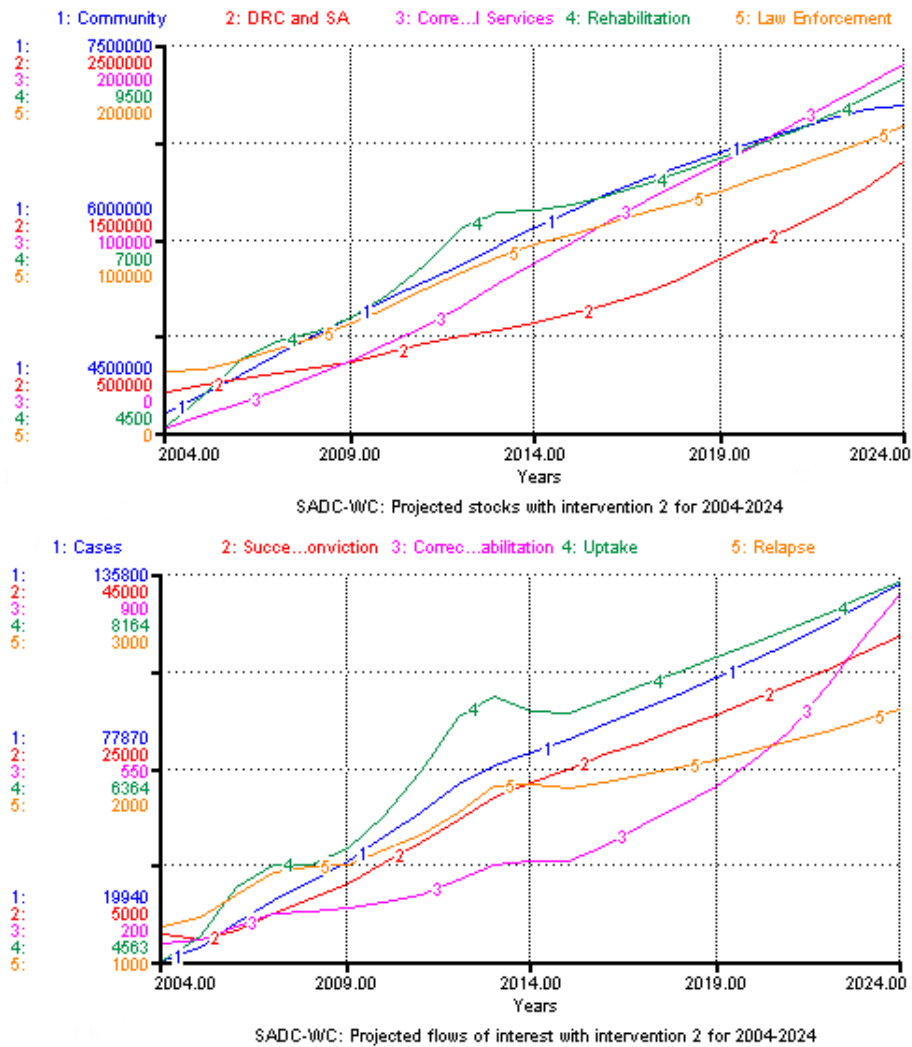

Figure 4.10. Projected stocks and flows for the SADC-WC system with with increased correc-tional service referrals to rehabilitation centres, intervention 2, for 2004 – 2024.

in Figure 4.8, which show the system without any interventions. This again highlights the limited impact that rehabilitation centres can have on the syndemic in the Western Cape, because of their limited capacity. It might be assumed that if the capacity of rehabilitation centres are significantly increased over the next ten years, this intervention might show more promising results.

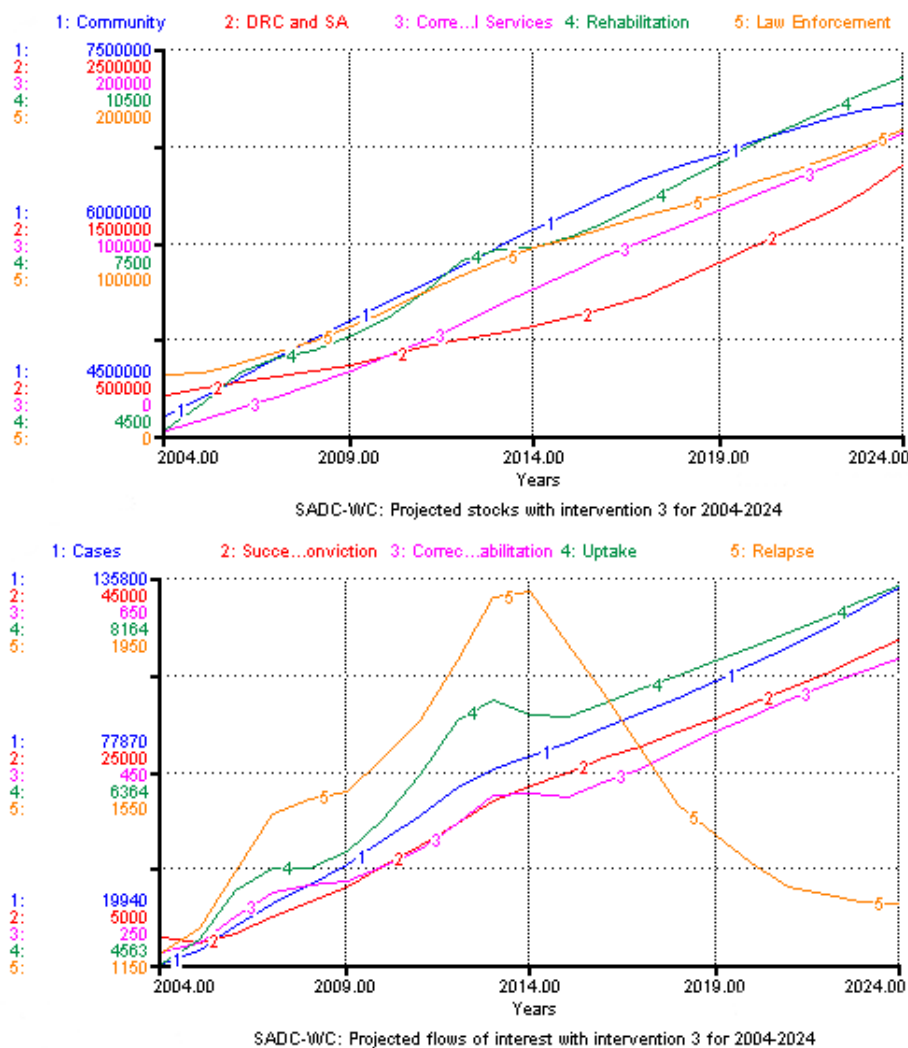

Figure 4.11. Projected stocks and flows for the SADC-WC system with reduced relapse into substance abuse, intervention 3, for 2004 – 2024.

## Conclusion

The model in this chapter is useful since it aids our understanding of the dynamics of substance abuse and drug-related crime in the Western Cape. The model proposes that substance abuse and drug-related crime spread like a disease, and comparatively demonstrates leverage points for interventions. In Chapter 5 a discussion on the comparison of the model presented in Chapter 3 and the model in the SADC-WC system model follows, recalling observations of the simulations, mentioning model limitations, finally concluding with suggestions for model extensions and suggestions for future work.

## Chapter 5

### Discussion and conclusion

This chapter discusses the conclusions that can be drawn from our research results. In Chapter 3, we used non-linear ordinary differential equations (ODEs), in order to formulate a deterministic mathematical model for the substance abuse and drug-related crime syndemic in the Western Cape. We determined the threshold number of the syndemic namely, the reproduction number  $\mathcal{R}_0$ . The impact of innovation of susceptible individuals into substance use and drug-related crime, was included into the model as initiation independent of contact with drug users or drug-related criminals.

The existence of the drug-free equilibrium were proven, indicating that when  $\mathcal{R}_0 < 1$ , the subsequent generation of drug users will be less that their predecessors. The drug persistent equilibrium/equilibria were proven to exist under specific conditions, when  $\mathcal{R}_0 < 1$ , as well as for the condition where  $\mathcal{R}_0 < 1$ . Because of the complexity of the model, the analysis of the drug persistent equilibria proved to be very difficult. Because of the complexity encountered in the model, only limited assumptions could be made about the behaviour of the syndemic when  $\mathcal{R}_0 < 1$ . This is one of the main reasons why the model is explored later from a systems perspective, where complexity of such a model can be overcome.

Sensitivity analysis was used to determine how various parameters influence the threshold number,  $\mathcal{R}_0$ , of the syndemic. The impact that successful convictions have on the reproduction number were significant. The results suggest therefore, that actions that are taken to contain or reduce the syndemic of substance abuse and drug-related crime

in the Western Cape, should be aiming at increasing successful convictions. This can be done by either increasing the drug-related crime cases that make it to court, or by increasing the rate of successful conviction that already made it to court.

Several challenges were encountered during the construction, and analysis, of the deterministic model. Firstly, we were not able to utilize the data we have for drug-related crime cases. Neither, were we able to use the data we have for individuals in rehabilitation for the period 2004 – 2014. When a deterministic model is constructed, every compartment and parameter increase the complexity of the model, which is a constraint for non linear systems. As explained earlier, this can cause challenges in the analysis of the model. The rigidity of ODE models prohibit varying parameters over time, which is difficult when one is studying heterogeneous populations, as the case is in the Western Cape. Similarly, the rigidity of compartmental models can not take “feedback loops” into account, implying that the flow into a compartment can not be governed by its own dynamics “within” the compartment.

Future work for the deterministic model should include additional efforts to locate empirical support for model parameters, and model structure, to develop the model further. Bifurcation behaviour can be investigated for the drug persistent equilibrium, in order to extend the work that was already done in Chapter 3.

In Chapter 4 the syndemic of substance abuse and drug-related crime in the Western Cape was imported into a system dynamics model on a STELLA platform, namely the SADC-WC system. The SADC-WC model was calibrated against historical data, suggesting that results and findings of the model merit exploration. The SADC-WC system was an extension of the deterministic model in Chapter 3, by including the Law enforcement stock. This enabled us to use known data from the SAPS of drug-related cases made per year in the Western Cape. Therefore, we expect that the successful conviction flow depicted by the simulations are closely related to the current successful conviction rates in the Western Cape. Another advantage of STELLA is the possibility of varying specific parameters such as death rates or initiation rates, which will normally be restricted within deterministic models that demand fixed values for the parameters.

From the simulations for the 2004 – 2024 system we were able to predict that the drug-related crime will grow unceasingly if no change within the system occur very soon. Three different changes within the system were investigated as interventions: (1) As-

suming the cases making court and successful convictions will double over the next ten years. (2) Assuming that the rate at which correctional services refer individuals to rehabilitation centres over the next ten years is doubled and, (3) assuming that there will be a decrease in the percentage of individuals that relapse back into substance abuse and drug-related crime ( $D$ ) over the next ten years. The only intervention that seemed to have a significant impact on the system, was increasing the number of successful convictions over the next ten years. This was done, by doubling the cases that make it to court and doubling the successful conviction rate. This showed notable lower stock counts for law enforcement, in comparison with the other two suggested interventions. It was noted that focussing interventions on flows, that are governed by small stocks (in comparison to other stocks in the system), limits the impact the intervention can have on the SADC-WC system as a whole. The system dynamics model highlighted this phenomena in intervention (2) and (3), where both flows that the interventions were focused on (correctional service referrals and relapse), are governed by the dynamics of the rehabilitation stock which is notably the smallest stock in the system.

The shortfall of systems in STELLA is that all the input data for the operation of the systems dynamic model is dependent on external generation. The lack of quality and complete data for the specific focus of the model, limits the credibility and accuracy of all the flows in the model. Hence the credibility and accuracy for predictions of the interventions is questionable as well. We suggest an expanding the SADC-WC model by creating three separate stocks to represent the syndemic, namely one for substance users, another for drug-related criminal activity and thirdly a stock for the individuals involved in both. Also, it is recommended to include the Judiciary as a stock, and to further investigate how the flow of cases making it to court from the law enforcement influence successful convictions. The last mentioned recommendation is especially of interest with regards to the observation in the model that successful convictions a key factor is in the encampment of drug-related crime.

The results and finding of both these model are only general foresights that can be used as a tool to improve the understanding of the dynamics of the substance abuse and drug-related crime syndemic over time. Although, the fact that both models highlighted the possibility that successful convictions hold with respect to encamping drug-related crime, and concurrently containing substance use is relevant and merit consideration.

The complex dynamics of substance abuse and drug-related crime exposed in this study



indicate that all the different key players (political actors, funders, program implementers, researchers and the public) need to stand together to counter force this syndemic in the Western Cape. One of the challenges of complex system, like the one at hand, is that often different key players have competing goals. For instance, where some communities are dependent on drug trafficking for financial income and their goal is to expand the drug network which escalate the use of substances and drug-related crime. The goal of law enforcement is to dispose all drug-related criminal activity. Rehabilitation centres also aim to decrease and eliminate substance abuse, by helping addicts to permanently quit the use of drugs. This research offers valuable insights for countries facing similar problems with substance abuse and drug-related crime such as South Africa.

# Appendix A

## STELLA equations

### A.1 Equations for the SADC-WC system model for 2004 – 2014



```







Community(t) = Community(t - dt) + (Successful_Rehabilitation + Self_Conviction +
Successful_Correction + Inflow - Initiation - Outflow) * dt
INIT Community = 4645600
INFLOWS:
  Successful_Rehabilitation = Rehabilitation*sr
  Self_Conviction = DRC_and_SA*se
  Successful_Correction = Correctional_Services*sc
  Inflow = Community*b+m
OUTFLOWS:
  Initiation =
  ((Community*DRC_and_SA*di)+(Community*DRC_and_SA*ci))/(Community+DRC_and_SA+
  Rehabilitation+Correctional_Services)
  Outflow = Community*d
Correctional_Services(t) = Correctional_Services(t - dt) + (Successful_Conviction -
Correctional_Rehabilitation - S_Death - Successful_Correction) * dt
INIT Correctional_Services = 1902
INFLOWS:
  Successful_Conviction = Law_Enforcement*s
OUTFLOWS:
  Correctional_Rehabilitation = Rehabilitation*cc
  S_Death = Correctional_Services*sd
  Successful_Correction = Correctional_Services*sc
DRC_and_SA(t) = DRC_and_SA(t - dt) + (Initiation + Relapse - Uptake - Successful_Conviction -
D_Death - Self_Conviction) * dt
INIT DRC_and_SA = 696840
INFLOWS:
  Initiation =
  ((Community*DRC_and_SA*di)+(Community*DRC_and_SA*ci))/(Community+DRC_and_SA+
  Rehabilitation+Correctional_Services)
  Relapse = Rehabilitation*r
OUTFLOWS:
  Uptake = GRAPH(TIME)
  (2004, 4563), (2006, 5458), (2008, 5444), (2010, 6067), (2012, 7090), (2014, 6808), (2016,
  7060), (2018, 7321), (2020, 7592), (2022, 7873), (2024, 8164)
  Successful_Conviction = Law_Enforcement*s
  D_Death = DRC_and_SA*dd
  Self_Conviction = DRC_and_SA*se
Law_Enforcement(t) = Law_Enforcement(t - dt) + (Cases - Failed_Convictions -
Successful_Convictions) * dt
INIT Law_Enforcement = 30432
INFLOWS:
  Cases = GRAPH(TIME)
  (2004, 19940), (2006, 34788), (2008, 45985), (2010, 60409), (2012, 76650), (2014, 84337),
  (2016, 92771), (2018, 102048), (2020, 112253), (2022, 123478), (2024, 135825)
OUTFLOWS:
  Failed_Convictions = Law_Enforcement*fc
  Successful_Convictions = Law_Enforcement*s*c

```

- $\text{Rehabilitation}(t) = \text{Rehabilitation}(t - dt) + (\text{Uptake} + \text{Correctional\_Rehabilitation} - \text{Successful\_Rehabilitation} - \text{R\_Death} - \text{Relapse}) * dt$   
 INIT Rehabilitation = 4563
- INFLOWS:
- Uptake = GRAPH(TIME)  
 (2004, 4563), (2005, 4600), (2006, 5458), (2007, 5920), (2008, 5444), (2009, 6309), (2010, 6067), (2011, 5660), (2012, 7090), (2013, 7195), (2014, 6808)
  - Correctional\_Rehabilitation = Rehabilitation\*cc
- OUTFLOWS:
- Successful\_Rehabilitation = Rehabilitation\*sr
  - R\_Death = Rehabilitation\*rd
  - Relapse = Rehabilitation\*r
- b = 0.023
  - c = 0.25
  - cc = 0.057
  - ci = GRAPH(TIME )  
 (2004, 0.0598), (2005, 0.0614), (2006, 0.0625), (2007, 0.0657), (2008, 0.0708), (2009, 0.076), (2010, 0.079), (2011, 0.0811), (2012, 0.0835), (2013, 0.0868), (2014, 0.0908)
  - d = 0.013
  - dd = GRAPH(TIME)  
 (2004, 0.0175), (2005, 0.0192), (2006, 0.0194), (2007, 0.018), (2008, 0.018), (2009, 0.0195), (2010, 0.0194), (2011, 0.0176), (2012, 0.0185), (2013, 0.0195), (2014, 0.0192)
  - di = GRAPH(TIME)  
 (2004, 0.0613), (2005, 0.0638), (2006, 0.0667), (2007, 0.0694), (2008, 0.0724), (2009, 0.0749), (2010, 0.0789), (2011, 0.0824), (2012, 0.0849), (2013, 0.0879), (2014, 0.0946)
  - fc = 0.75
  - m = 152230
  - r = 0.257
  - rd = GRAPH(TIME)  
 (2004, 0.016), (2005, 0.0178), (2006, 0.0187), (2007, 0.0188), (2008, 0.018), (2009, 0.0161), (2010, 0.0161), (2011, 0.0169), (2012, 0.0186), (2013, 0.0188), (2014, 0.0186)
  - s = 0.25
  - sc = ((1/2.5) \* 0.31 + (1/10) \* 0.42 + (1/12.5) \* 0.10 + (1/30) \* 0.16)
  - sd = GRAPH(TIME)  
 (2004, 0.019), (2005, 0.0191), (2006, 0.0188), (2007, 0.0169), (2008, 0.0163), (2009, 0.0164), (2010, 0.0192), (2011, 0.019), (2012, 0.0179), (2013, 0.0165), (2014, 0.0166)
  - se = GRAPH(TIME)  
 (2004, 0.0152), (2005, 0.0358), (2006, 0.0376), (2007, 0.0171), (2008, 0.0416), (2009, 0.043), (2010, 0.0382), (2011, 0.0194), (2012, 0.0341), (2013, 0.0363), (2014, 0.0198)
  - sr = 0.7

## A.2 Equations for the SADC-WC system model for 2004 – 2024









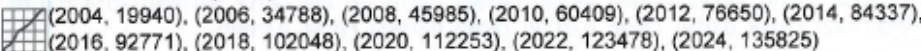

- Community(t) = Community(t - dt) + (Successful\_Rehabilitation + Self\_Conviction + Successful\_Correction + Inflow - Initiation - Outflow) \* dt  
INIT Community = 4645600  
INFLOWS:  
 Successful\_Rehabilitation = Rehabilitation\*sr  
 Self\_Conviction = DRC\_and\_SA\*se  
 Successful\_Correction = Correctional\_Services\*sc  
 Inflow = Community\*b+m  
 OUTFLOWS:  
 Initiation =  $((Community * DRC\_and\_SA * di) + (Community * DRC\_and\_SA * ci)) / (Community + DRC\_and\_SA + Rehabilitation + Correctional\_Services)$   
 Outflow = Community\*d
- Correctional\_Services(t) = Correctional\_Services(t - dt) + (Successful\_Conviction - Correctional\_Rehabilitation - S\_Death - Successful\_Correction) \* dt  
INIT Correctional\_Services = 1902  
INFLOWS:  
 Successful\_Conviction = Law\_Enforcement\*s  
 OUTFLOWS:  
 Correctional\_Rehabilitation = Rehabilitation\*cc  
 S\_Death = Correctional\_Services\*sd  
 Successful\_Correction = Correctional\_Services\*sc
- DRC\_and\_SA(t) = DRC\_and\_SA(t - dt) + (Initiation + Relapse - Uptake - Successful\_Conviction - D\_Death - Self\_Conviction) \* dt  
INIT DRC\_and\_SA = 696840  
INFLOWS:  
 Initiation =  $((Community * DRC\_and\_SA * di) + (Community * DRC\_and\_SA * ci)) / (Community + DRC\_and\_SA + Rehabilitation + Correctional\_Services)$   
 Relapse = Rehabilitation\*r  
 OUTFLOWS:  
 Uptake = GRAPH(TIME)  
  
 Successful\_Conviction = Law\_Enforcement\*s  
 D\_Death = DRC\_and\_SA\*dd  
 Self\_Conviction = DRC\_and\_SA\*se
- Law\_Enforcement(t) = Law\_Enforcement(t - dt) + (Cases - Failed\_Convictions - Successful\_Convictions) \* dt  
INIT Law\_Enforcement = 30432  
INFLOWS:  
 Cases = GRAPH(TIME)  
  
 OUTFLOWS:  
 Failed\_Convictions = Law\_Enforcement\*fc  
 Successful\_Convictions = Law\_Enforcement\*s\*c

- Rehabilitation(t) = Rehabilitation(t - dt) + (Uptake + Correctional\_Rehabilitation - Successful\_Rehabilitation - R\_Death - Relapse) \* dt  
INIT Rehabilitation = 4563
- INFLOWS:
- Uptake = GRAPH(TIME)  
 (2004, 4563), (2006, 5458), (2008, 5444), (2010, 6067), (2012, 7090), (2014, 6808), (2016, 7060), (2018, 7321), (2020, 7592), (2022, 7873), (2024, 8164)
  - Correctional\_Rehabilitation = Rehabilitation\*cc
- OUTFLOWS:
- Successful\_Rehabilitation = Rehabilitation\*sr
  - R\_Death = Rehabilitation\*rd
  - Relapse = Rehabilitation\*r
- b = .023
  - c = 0.25
  - cc = 0.057
  - ci = GRAPH(TIME)  
 (2004, 0.0598), (2006, 0.0614), (2008, 0.0625), (2010, 0.0657), (2012, 0.0708), (2014, 0.076), (2016, 0.079), (2018, 0.0811), (2020, 0.0835), (2022, 0.0868), (2024, 0.0908)
  - d = 0.013
  - dd = GRAPH(TIME)  
 (2004, 0.0175), (2006, 0.0192), (2008, 0.0194), (2010, 0.018), (2012, 0.018), (2014, 0.0195), (2016, 0.0194), (2018, 0.0176), (2020, 0.0185), (2022, 0.0195), (2024, 0.0192)
  - di = GRAPH(TIME)  
 (2004, 0.0613), (2006, 0.0638), (2008, 0.0667), (2010, 0.0694), (2012, 0.0724), (2014, 0.0749), (2016, 0.0789), (2018, 0.0824), (2020, 0.0849), (2022, 0.0879), (2024, 0.0946)
  - fc = 0.75
  - m = 152230
  - r = 0.257
  - rd = GRAPH(TIME)  
 (2004, 0.016), (2006, 0.0178), (2008, 0.0187), (2010, 0.0188), (2012, 0.018), (2014, 0.0161), (2016, 0.0161), (2018, 0.0169), (2020, 0.0186), (2022, 0.0188), (2024, 0.0186)
  - s = 0.25
  - sc = (1/2.5\*0.31+1-10+0.42+1/12.5\*0.10+1/30\*0.16)
  - sd = GRAPH(TIME)  
 (2004, 0.019), (2006, 0.0191), (2008, 0.0188), (2010, 0.0169), (2012, 0.0163), (2014, 0.0164), (2016, 0.0192), (2018, 0.019), (2020, 0.0179), (2022, 0.0165), (2024, 0.0166)
  - se = GRAPH(TIME)  
 (2004, 0.0152), (2006, 0.0358), (2008, 0.0376), (2010, 0.0171), (2012, 0.0416), (2014, 0.043), (2016, 0.0382), (2018, 0.0194), (2020, 0.0341), (2022, 0.0363), (2024, 0.0198)
  - sr = 0.7

### A.3 Equations for the SADC-WC system model for 2004 – 2024 with intervention 1

- Community(t) = Community(t - dt) + (Successful\_Rehabilitation + Self\_Conviction + Successful\_Correction + Inflow - Initiation - Outflow) \* dt  
INIT Community = 4645600
- INFLOWS:
- ☞ Successful\_Rehabilitation = Rehabilitation\*sr
  - ☞ Self\_Conviction = DRC\_and\_SA\*se
  - ☞ Successful\_Correction = Correctional\_Services\*((1/2.5) \* 0.31 + (1/10) \* 0.42 + (1/12.5) \* 0.10 + (1/30) \* 0.16)
  - ☞ Inflow = Community\*b+m
- OUTFLOWS:
- ☞ Initiation = ((Community\*DRC\_and\_SA\*di)+(Community\*DRC\_and\_SA\*ci))/(Community+DRC\_and\_SA+Rehabilitation+Correctional\_Services)
  - ☞ Outflow = Community\*d
- Correctional\_Services(t) = Correctional\_Services(t - dt) + (Successful\_Conviction - Correctional\_Rehabilitation - S\_Death - Successful\_Correction) \* dt  
INIT Correctional\_Services = 1902
- INFLOWS:
- ☞ Successful\_Conviction = Law\_Enforcement\*s
- OUTFLOWS:
- ☞ Correctional\_Rehabilitation = Rehabilitation\*cc
  - ☞ S\_Death = Correctional\_Services\*sd
  - ☞ Successful\_Correction = Correctional\_Services\*((1/2.5) \* 0.31 + (1/10) \* 0.42 + (1/12.5) \* 0.10 + (1/30) \* 0.16)
- DRC\_and\_SA(t) = DRC\_and\_SA(t - dt) + (Initiation + Relapse - Uptake - Successful\_Conviction - D\_Death - Self\_Conviction) \* dt  
INIT DRC\_and\_SA = 696840
- INFLOWS:
- ☞ Initiation = ((Community\*DRC\_and\_SA\*di)+(Community\*DRC\_and\_SA\*ci))/(Community+DRC\_and\_SA+Rehabilitation+Correctional\_Services)
  - ☞ Relapse = Rehabilitation\*r
- OUTFLOWS:
- ☞ Uptake = GRAPH(TIME)  

  - ☞ Successful\_Conviction = Law\_Enforcement\*s
  - ☞ D\_Death = DRC\_and\_SA\*dd
  - ☞ Self\_Conviction = DRC\_and\_SA\*se
- Law\_Enforcement(t) = Law\_Enforcement(t - dt) + (Cases - Failed\_Convictions - Successful\_Convictions) \* dt  
INIT Law\_Enforcement = 30432
- INFLOWS:
- ☞ Cases = GRAPH(TIME)  

- OUTFLOWS:
- ☞ Failed\_Convictions = Law\_Enforcement\*fc
  - ☞ Successful\_Convictions = Law\_Enforcement\*s\*c

- $\text{Rehabilitation}(t) = \text{Rehabilitation}(t - dt) + (\text{Uptake} + \text{Correctional\_Rehabilitation} - \text{Successful\_Rehabilitation} - \text{R\_Death} - \text{Relapse}) * dt$   
 INIT Rehabilitation = 4563
- INFLOWS:
- Uptake = GRAPH(TIME)  
 (2004, 4563), (2006, 5458), (2008, 5444), (2010, 6067), (2012, 7090), (2014, 6808), (2016, 7060), (2018, 7321), (2020, 7592), (2022, 7873), (2024, 8164)
  - Correctional\_Rehabilitation = Rehabilitation\*cc
- OUTFLOWS:
- Successful\_Rehabilitation = Rehabilitation\*sr
  - R\_Death = Rehabilitation\*rd
  - Relapse = Rehabilitation\*r
- b = .023
- c = GRAPH(TIME)  
 (2004, 0.251), (2005, 0.252), (2006, 0.254), (2007, 0.254), (2008, 0.254), (2009, 0.254), (2010, 0.254), (2011, 0.254), (2012, 0.254), (2013, 0.256), (2014, 0.259), (2015, 0.267), (2016, 0.279), (2017, 0.3), (2018, 0.319), (2019, 0.337), (2020, 0.357), (2021, 0.371), (2022, 0.387), (2023, 0.429), (2024, 0.5)
- cc = 0.057
- ci = GRAPH(TIME )  
 (2004, 0.0598), (2006, 0.0614), (2008, 0.0625), (2010, 0.0657), (2012, 0.0708), (2014, 0.076), (2016, 0.079), (2018, 0.0811), (2020, 0.0835), (2022, 0.0868), (2024, 0.0908)
- d = 0.013
- dd = GRAPH(TIME)  
 (2004, 0.0175), (2006, 0.0192), (2008, 0.0194), (2010, 0.018), (2012, 0.018), (2014, 0.0195), (2016, 0.0194), (2018, 0.0176), (2020, 0.0185), (2022, 0.0195), (2024, 0.0192)
- di = GRAPH(TIME)  
 (2004, 0.0613), (2006, 0.0638), (2008, 0.0667), (2010, 0.0694), (2012, 0.0724), (2014, 0.0749), (2016, 0.0789), (2018, 0.0824), (2020, 0.0849), (2022, 0.0879), (2024, 0.0946)
- fc = 0.75
- m = 152230
- r = 0.257
- rd = GRAPH(TIME)  
 (2004, 0.016), (2006, 0.0178), (2008, 0.0187), (2010, 0.0188), (2012, 0.018), (2014, 0.0161), (2016, 0.0161), (2018, 0.0169), (2020, 0.0186), (2022, 0.0188), (2024, 0.0186)
- s = GRAPH(TIME)  
 (2004, 0.249), (2005, 0.249), (2006, 0.249), (2007, 0.251), (2008, 0.251), (2009, 0.249), (2010, 0.248), (2011, 0.252), (2012, 0.254), (2013, 0.252), (2014, 0.256), (2015, 0.265), (2016, 0.283), (2017, 0.295), (2018, 0.31), (2019, 0.33), (2020, 0.348), (2021, 0.373), (2022, 0.416), (2023, 0.463), (2024, 0.5)
- sc = GRAPH(TIME)  
 (2004, 0.194), (2005, 0.38), (2006, 0.45), (2007, 0.413), (2008, 0.259), (2009, 0.212), (2010, 0.163), (2011, 0.141), (2012, 0.119), (2013, 0.107), (2014, 0.111)
- sd = GRAPH(TIME)  
 (2004, 0.019), (2006, 0.0191), (2008, 0.0188), (2010, 0.0169), (2012, 0.0163), (2014, 0.0164), (2016, 0.0192), (2018, 0.019), (2020, 0.0179), (2022, 0.0165), (2024, 0.0166)
- se = GRAPH(TIME)  
 (0.00, 0.0152), (202, 0.0358), (405, 0.0376), (607, 0.0171), (810, 0.0416), (1012, 0.043), (1214, 0.0382), (1417, 0.0194), (1619, 0.0341), (1822, 0.0363), (2024, 0.0198)

## A.4 Equations for the SADC-WC system model for 2004 – 2024 with intervention 2







- Community(t) = Community(t - dt) + (Successful\_Rehabilitation + Self\_Conviction + Successful\_Correction + Inflow - Initiation - Outflow) \* dt  
INIT Community = 4645600  
INFLOWS:  
 Successful\_Rehabilitation = Rehabilitation\*sr  
 Self\_Conviction = DRC\_and\_SA\*se  
 Successful\_Correction = Correctional\_Services\*sc  
 Inflow = Community\*b+m  
 OUTFLOWS:  
 Initiation =  

$$\frac{((Community * DRC\_and\_SA * di) + (Community * DRC\_and\_SA * ci))}{(Community + DRC\_and\_SA + Rehabilitation + Correctional\_Services)}$$
 Outflow = Community\*d
- Correctional\_Services(t) = Correctional\_Services(t - dt) + (Successful\_Conviction - Correctional\_Rehabilitation - S\_Death - Successful\_Correction) \* dt  
INIT Correctional\_Services = 1902  
INFLOWS:  
 Successful\_Conviction = Law\_Enforcement\*s  
 OUTFLOWS:  
 Correctional\_Rehabilitation = Rehabilitation\*cc  
 S\_Death = Correctional\_Services\*sd  
 Successful\_Correction = Correctional\_Services\*sc
- DRC\_and\_SA(t) = DRC\_and\_SA(t - dt) + (Initiation + Relapse - Uptake - Successful\_Conviction - D\_Death - Self\_Conviction) \* dt  
INIT DRC\_and\_SA = 696840  
INFLOWS:  
 Initiation =  

$$\frac{((Community * DRC\_and\_SA * di) + (Community * DRC\_and\_SA * ci))}{(Community + DRC\_and\_SA + Rehabilitation + Correctional\_Services)}$$
 Relapse = Rehabilitation\*r  
 OUTFLOWS:  
 Uptake = GRAPH(TIME)  

 Successful\_Conviction = Law\_Enforcement\*s  
 D\_Death = DRC\_and\_SA\*dd  
 Self\_Conviction = DRC\_and\_SA\*se
- Law\_Enforcement(t) = Law\_Enforcement(t - dt) + (Cases - Failed\_Convictions - Successful\_Convictions) \* dt  
INIT Law\_Enforcement = 30432  
INFLOWS:  
 Cases = GRAPH(TIME)  
  
 OUTFLOWS:  
 Failed\_Convictions = Law\_Enforcement\*fc  
 Successful\_Convictions = Law\_Enforcement\*s\*c



- Rehabilitation(t) = Rehabilitation(t - dt) + (Uptake + Correctional\_Rehabilitation - Successful\_Rehabilitation - R\_Death - Relapse) \* dt  
INIT Rehabilitation = 4563
- INFLOWS:
- Uptake = GRAPH(TIME)  
 (2004, 4563), (2006, 5458), (2008, 5444), (2010, 6067), (2012, 7090), (2014, 6808), (2016, 7060), (2018, 7321), (2020, 7592), (2022, 7873), (2024, 8164)
  - Correctional\_Rehabilitation = Rehabilitation\*cc
- OUTFLOWS:
- Successful\_Rehabilitation = Rehabilitation\*sr
  - R\_Death = Rehabilitation\*rd
  - Relapse = Rehabilitation\*r
- b = .023
  - c = 0.25
  - cc = GRAPH(TIME)  
 (2004, 0.0498), (2005, 0.0498), (2006, 0.0502), (2007, 0.05), (2008, 0.05), (2009, 0.0505), (2010, 0.0498), (2011, 0.0498), (2012, 0.0502), (2013, 0.0508), (2014, 0.0508), (2015, 0.0521), (2016, 0.0562), (2017, 0.06), (2018, 0.0629), (2019, 0.067), (2020, 0.0705), (2021, 0.0775), (2022, 0.086), (2023, 0.093), (2024, 0.1)
  - ci = GRAPH(TIME)  
 (2004, 0.0598), (2006, 0.0614), (2008, 0.0625), (2010, 0.0657), (2012, 0.0708), (2014, 0.076), (2016, 0.079), (2018, 0.0811), (2020, 0.0835), (2022, 0.0868), (2024, 0.0908)
  - d = 0.013
  - dd = GRAPH(TIME)  
 (2004, 0.0175), (2006, 0.0192), (2008, 0.0194), (2010, 0.018), (2012, 0.018), (2014, 0.0195), (2016, 0.0194), (2018, 0.0176), (2020, 0.0185), (2022, 0.0195), (2024, 0.0192)
  - di = GRAPH(TIME)  
 (2004, 0.0613), (2006, 0.0638), (2008, 0.0667), (2010, 0.0694), (2012, 0.0724), (2014, 0.0749), (2016, 0.0789), (2018, 0.0824), (2020, 0.0849), (2022, 0.0879), (2024, 0.0946)
  - fc = 0.75
  - m = 152230
  - r = 0.257
  - rd = GRAPH(TIME)  
 (2004, 0.016), (2006, 0.0178), (2008, 0.0187), (2010, 0.0188), (2012, 0.018), (2014, 0.0161), (2016, 0.0161), (2018, 0.0169), (2020, 0.0186), (2022, 0.0188), (2024, 0.0186)
  - s = 0.25
  - sc = (1/2.5\*0.31+1/10\*0.42\*1/12.5\*0.10+1/30\*0.16)
  - sd = GRAPH(TIME)  
 (2004, 0.019), (2006, 0.0191), (2008, 0.0188), (2010, 0.0169), (2012, 0.0163), (2014, 0.0164), (2016, 0.0192), (2018, 0.019), (2020, 0.0179), (2022, 0.0165), (2024, 0.0166)
  - se = GRAPH(TIME)  
 (2004, 0.0152), (2006, 0.0358), (2008, 0.0376), (2010, 0.0171), (2012, 0.0416), (2014, 0.043), (2016, 0.0382), (2018, 0.0194), (2020, 0.0341), (2022, 0.0363), (2024, 0.0198)
  - sr = 0.7

## A.5 Equations for the SADC-WC system model for 2004 – 2024 with intervention 3

- $\text{Community}(t) = \text{Community}(t - dt) + (\text{Successful\_Rehabilitation} + \text{Self\_Conviction} + \text{Successful\_Correction} + \text{Inflow} - \text{Initiation} - \text{Outflow}) * dt$   
 INIT Community = 4645600  
 INFLOWS:  
 ↳ Successful\_Rehabilitation = Rehabilitation\*sr  
 ↳ Self\_Conviction = DRC\_and\_SA\*se  
 ↳ Successful\_Correction = Correctional\_Services\*sc  
 ↳ Inflow = Community\*b+m  
 OUTFLOWS:  
 ↳ Initiation =  
 ((Community\*DRC\_and\_SA\*di)+(Community\*DRC\_and\_SA\*ci))/(Community+DRC\_and\_SA+Rehabilitation+Correctional\_Services)  
 ↳ Outflow = Community\*d
- $\text{Correctional\_Services}(t) = \text{Correctional\_Services}(t - dt) + (\text{Successful\_Conviction} - \text{Correctional\_Rehabilitation} - \text{S\_Death} - \text{Successful\_Correction}) * dt$   
 INIT Correctional\_Services = 1902  
 INFLOWS:  
 ↳ Successful\_Conviction = Law\_Enforcement\*s  
 OUTFLOWS:  
 ↳ Correctional\_Rehabilitation = Rehabilitation\*cc  
 ↳ S\_Death = Correctional\_Services\*sd  
 ↳ Successful\_Correction = Correctional\_Services\*sc
- $\text{DRC\_and\_SA}(t) = \text{DRC\_and\_SA}(t - dt) + (\text{Initiation} + \text{Relapse} - \text{Uptake} - \text{Successful\_Conviction} - \text{D\_Death} - \text{Self\_Conviction}) * dt$   
 INIT DRC\_and\_SA = 696840  
 INFLOWS:  
 ↳ Initiation =  
 ((Community\*DRC\_and\_SA\*di)+(Community\*DRC\_and\_SA\*ci))/(Community+DRC\_and\_SA+Rehabilitation+Correctional\_Services)  
 ↳ Relapse = Rehabilitation\*r  
 OUTFLOWS:  
 ↳ Uptake = GRAPH(TIME)  
 (2004, 4563), (2005, 4600), (2006, 5458), (2007, 5920), (2008, 5444), (2009, 6309), (2010, 6067), (2011, 5660), (2012, 7090), (2013, 7195), (2014, 6808)  
 ↳ Successful\_Conviction = Law\_Enforcement\*s  
 ↳ D\_Death = DRC\_and\_SA\*dd  
 ↳ Self\_Conviction = DRC\_and\_SA\*se
- $\text{Law\_Enforcement}(t) = \text{Law\_Enforcement}(t - dt) + (\text{Cases} - \text{Failed\_Convictions} - \text{Successful\_Convictions}) * dt$   
 INIT Law\_Enforcement = 30432  
 INFLOWS:  
 ↳ Cases = GRAPH(TIME)  
 (2004, 19940), (2005, 30432), (2006, 34788), (2007, 41067), (2008, 45985), (2009, 52781), (2010, 60409), (2011, 70588), (2012, 76650), (2013, 82062), (2014, 84337)  
 OUTFLOWS:  
 ↳ Failed\_Convictions = Law\_Enforcement\*fc  
 ↳ Successful\_Convictions = Law\_Enforcement\*s\*c

- $\text{Rehabilitation}(t) = \text{Rehabilitation}(t - dt) + (\text{Uptake} + \text{Correctional\_Rehabilitation} - \text{Successful\_Rehabilitation} - \text{R\_Death} - \text{Relapse}) * dt$   
 INIT Rehabilitation = 4563
- INFLOWS:
- Uptake = GRAPH(TIME)  
 (2004, 4563), (2006, 5458), (2008, 5444), (2010, 6067), (2012, 7090), (2014, 6808), (2016, 7060), (2018, 7321), (2020, 7592), (2022, 7873), (2024, 8164)
  - Correctional\_Rehabilitation = Rehabilitation\*cc
- OUTFLOWS:
- Successful\_Rehabilitation = Rehabilitation\*sr
  - R\_Death = Rehabilitation\*rd
  - Relapse = Rehabilitation\*r
- b = .023
  - c = 0.25
  - cc = 0.057
  - ci = GRAPH(TIME)  
 (2004, 0.0598), (2006, 0.0614), (2008, 0.0625), (2010, 0.0657), (2012, 0.0708), (2014, 0.076), (2016, 0.079), (2018, 0.0811), (2020, 0.0835), (2022, 0.0868), (2024, 0.0908)
  - d = 0.013
  - dd = GRAPH(TIME)  
 (2004, 0.0175), (2006, 0.0192), (2008, 0.0194), (2010, 0.018), (2012, 0.018), (2014, 0.0195), (2016, 0.0194), (2018, 0.0176), (2020, 0.0185), (2022, 0.0195), (2024, 0.0192)
  - di = GRAPH(TIME)  
 (2004, 0.0613), (2006, 0.0638), (2008, 0.0667), (2010, 0.0694), (2012, 0.0724), (2014, 0.0749), (2016, 0.0789), (2018, 0.0824), (2020, 0.0849), (2022, 0.0879), (2024, 0.0946)
  - fc = 0.75
  - m = 152230
  - r = GRAPH(TIME)  
 (2004, 0.257), (2005, 0.257), (2006, 0.257), (2007, 0.257), (2008, 0.257), (2009, 0.257), (2010, 0.257), (2011, 0.257), (2012, 0.257), (2013, 0.257), (2014, 0.257), (2015, 0.232), (2016, 0.215), (2017, 0.188), (2018, 0.171), (2019, 0.159), (2020, 0.147), (2021, 0.139), (2022, 0.135), (2023, 0.129), (2024, 0.127)
  - rd = GRAPH(TIME)  
 (2004, 0.016), (2006, 0.0178), (2008, 0.0187), (2010, 0.0188), (2012, 0.018), (2014, 0.0161), (2016, 0.0161), (2018, 0.0169), (2020, 0.0186), (2022, 0.0188), (2024, 0.0186)
  - s = 0.25
  - sc =  $((1/2.5) * 0.31 + (1/10) * 0.42 + (1/12.5) * 0.10 + (1/30) * 0.16)$
  - sd = GRAPH(TIME)  
 (2004, 0.019), (2006, 0.0191), (2008, 0.0188), (2010, 0.0169), (2012, 0.0163), (2014, 0.0164), (2016, 0.0192), (2018, 0.019), (2020, 0.0179), (2022, 0.0165), (2024, 0.0166)
  - se = GRAPH(TIME)  
 (2004, 0.0152), (2006, 0.0358), (2008, 0.0376), (2010, 0.0171), (2012, 0.0416), (2014, 0.043), (2016, 0.0382), (2018, 0.0194), (2020, 0.0341), (2022, 0.0363), (2024, 0.0198)
  - sr = 0.7

# Bibliography

- [1] Health 24. One in ten in South Africa has addiction problem. More than 11% of South Africans have addiction problems: and their top drugs of choice are dagga and alcohol. <http://www.health24.com/Lifestyle/Street-drugs/News/Dagga-alcohol-top-SA-drug-choices-20130618>, Online; accessed on 12 August 2015.
- [2] Thomas C.W. Corso L. & Monroe J .A. The value of the “system” in public health services and systems research. *American Journal of Public Health*, 2015.
- [3] Crime Stats South Africa. Crime Stats Simplified. <http://www.crimestatssa.com/index.php>, Online; accessed on 26 May 2015.
- [4] Statistics South Africa. Statistical release P0302 Mid-year population estimates,2014. <http://www.statssa.gov.za/publications/P0302/P03022014.pdf>, Online; accessed on 1 august 2015.
- [5] Statistics South Africa. South African Statistics, 2004/05. <http://www.statssa.gov.za/publications/SASStatistics/SASStatistics2004.pdf>, Online; accessed on 31 july 2015.
- [6] Pasche S. & Myers B. Substance misuse trends in South Africa. *Human Psychopharmacology: Clinical and Experimental*, 2012.
- [7] Richmond B. Systems Dynamics/Systems Thinking: Let’s just get on with it. <http://www.iseesystems.com/resources/Articles/SDSTletsjustgetonwithit.pdf>, Online; accessed on 8 June 2015.
- [8] White E. & Comiskey C. Heroin epidemics, treatment and ODE modelling. *Mathematical biosciences*, 2007.

- [9] Fletcher B.W. Chandler R.K. and Volkow N.D. Treating drug abuse and addiction in the criminal justice system: improving public health and safety. *JAMA*, 2009.
- [10] South African Law Commission. Research paper 18: Conviction rates and other outcomes of crimes reported in eight south african police areas. <http://www.justice.gov.za/salrc/rpapers/rp18.pdf>, Online; accessed on 1 august 2015.
- [11] Buonomo B. & Lacitignola D. Modeling peer influence effects on the spread of high-risk alcohol consumption behavior. *Ricerche di Matematica*, 2014.
- [12] Van den Driessche P. & Watmough J. Reproduction numbers and sub-threshold endemic equilibria for compartmental models of disease transmission. *Mathematical biosciences*, 2002.
- [13] Hamby D.M. A review of techniques for parameter sensitivity analysis of environmental models. *Environmental monitoring and assessment*, 1994.
- [14] White H.R. Gorman D.M. Dynamics of the drug-crime relationship. *Criminal Justice*, 2000.
- [15] Stapel E. Descartes rule of signs. <http://http://www.purplemath.com/modules/drofsign.htm>, Online; accessed on 02 August 2015.
- [16] Wolstenholme E.F. *System enquiry: a system dynamics approach*. John Wiley & Sons, Inc., 1990.
- [17] El-Jardali F. Adam T. et al. Constraints to applying systems thinking concepts in health systems: A regional perspective from surveying stakeholders in eastern mediterranean countries. *International journal of health policy and management*, 2014.
- [18] Johnson K. et al. SACENDU Monitoring alcohol, tobacco and drug abuse treatment admissions in South Africa August 2014 phase 35. <http://www.mrc.ac.za/adarg/sacendu/Sacenduphase35.pdf>, Online; accessed on 28 May 2015.
- [19] Johnson K. et al. SACENDU monitoring alcohol, tobacco and drug abuse treatment admissions in South Africa October 2008 phase 24. <http://www.mrc.ac.za/adarg/sacendu/sacendureport13.pdf>, Online; accessed on 28 May 2015.
- [20] Johnson K. et al. SACENDU research brief, vol 17 (1), 2014. <http://www.mrc.ac.za/adarg/sacendu/sacenduBriefJune2014.pdf>, Online; accessed on 28 May 2015.

- [21] Capra F. *The web of life: A new scientific understanding of living systems*. Anchor, 1996.
- [22] Kalula A.S. & Nyabadza F. A theoretical model for substance abuse in the presence of treatment. *South African Journal of Science*, 2012.
- [23] Njagarah J.B.H. & Nyabadza F. Modeling the impact of rehabilitation, amelioration and relapse on the prevalence of drug epidemics. *Journal of Biological Systems*, 2013.
- [24] Njagarah J.B.H. & Nyabadza F. Modelling the role of drug barons on the prevalence of drug epidemics. *Math Biosci Eng*, 2013.
- [25] Homer J.B. & Hirsch G.B. System dynamics modeling for public health: background and opportunities. *American journal of public health*, 2006.
- [26] Gorman D.M. Gruenewald P.J. et. al. Implications of systems dynamic models and control theory for environmental approaches to the prevention of alcohol-and other drug use-related problems. *Substance use & misuse*, 2004.
- [27] Blower S.M. & Dowlatabadi H. Sensitivity and uncertainty analysis fo complex-models of disease transmission an HIV model, as an example. *International Statistical Review*, 1994.
- [28] Holder H. Substance abuse treatment as part of a total system of community response. *Nordic Studies on Alcohol and Drugs*, 2010.
- [29] Wilson P.D. Hoare A. & Rega D.G. Sampling and sensitivity analyses tools (SaSAT) for computational modelling. *Theoretical Biology and Medical Modelling*, 2008.
- [30] Birckmayer J.D. Holder H.D et al. A general causal model to guide alcohol, tobacco, and illicit drug prevention: Assessing the research evidence. *Journal of Drug Education*, 2004.
- [31] White H.R. The drug use-delinquency connection in adolescence. *Drugs, crime and criminal justice*, 1990.
- [32] ISS Crime Hub. SA crime map: Crime statistics for each police precinct. <https://www.issafrica.org/crimehub/map>, Online; accessed on 5 August 2015.
- [33] Philibert I. Systems-based practice: to learn about and to improve the system. ACGME Bulletin. November, 2004. <https://www.acgme.org/acgmeweb/tabid/265/Publications/ArchivedE-Bulletin.aspx>, Online; accessed on 28 May 2014.

- [34] Fagan J. & Kolin C. Violence as regulation and social control in the distribution of crack. *Drugs and violence: Causes, correlates and consequences*, 1990.
- [35] Collins J.J. The relationship of problem drinking to individual offending sequences. *Drinking and crime*, 1981.
- [36] LaSalle J.P. The stability of dynamical systems. *Society for Industrial and Applied Mathematics*, 1976.
- [37] Boles S.M. & Miotto K. Substance abuse and violence: A review of the literature. *Aggression and Violent Behavior*, 2003.
- [38] Goga K. The drug trade and governance in Cape Town. *Institute for Security Studies Papers*, 2014.
- [39] Seekings J. & Thaler K. Violence and socioeconomic conditions in Cape Town. *The Economics of Peace and Security Journal*, 2014.
- [40] Beckman R.J. & Conocer W.J. McKay M.D. A comparison of three method for selecting values of input variables in the analysis of output from a computer code. *Technometrics*, 2000.
- [41] Katsaliaki K. & Mustafee N. Applications of simulation within the healthcare context. *Journal of the Operational Research Society*, 2011.
- [42] Confederation N.H.S. The potential of system dynamics: a new era of strategic planning. *Leading edge*, 2005.
- [43] Njagarah J.B.H. & Smith R.J. Nyabadza F. Modelling the dynamics of crystal meth ('tik') abuse in the presence of drug-supply chains in South Africa. *Bulletin of Mathematical Biology*, 2013.
- [44] Department of Community Safety. Report on the Western Cape policing needs and priorities, 2013/2014 PNP Report. [https://www.westerncape.gov.za/sites/www.westerncape.gov.za/files/w\\_cape\\_provincial\\_pnp\\_report\\_2013\\_14.pdf](https://www.westerncape.gov.za/sites/www.westerncape.gov.za/files/w_cape_provincial_pnp_report_2013_14.pdf), Online; accessed on 8 June 2015.
- [45] Department of Correctional Services. Annual report 2007. <http://www.dcs.gov.za/Publications/Annual%20Reports/DCS%20Annual%20Report%202007.pdf>, Online; accessed on 31 July 2015.

- [46] National Department of Health National Health Insurance in South Africa. A policy paper. Pretoria: National department of health. 2011. [http://www.gov.za/sites/www.gov.za/files/nationalhealthinsurance\\_2.pdf](http://www.gov.za/sites/www.gov.za/files/nationalhealthinsurance_2.pdf), Online; accessed on 28 May 2014.
- [47] South African Institute of Race Relations. Fast facts, South African Institute of Race Relations. [http://irr.org.za/reports-and-publications/fast-facts/fast-facts-2013/files/Fast\\_Facts\\_December\\_2013.pdf/at\\_download/file](http://irr.org.za/reports-and-publications/fast-facts/fast-facts-2013/files/Fast_Facts_December_2013.pdf/at_download/file), Online; accessed on 8 June 2015.
- [48] World Health Organization et al. The World Health Report 2008: Primary health care (now more than ever). *World Health Organization*, 2014.
- [49] Goldstein P. The Federal Government's response to illicit drugs. *The facts about drugs*, 1980.
- [50] Goldstein P. The drugs/violence nexus: A tripartite conceptual framework. *Journal of Drug Issues*, 1985.
- [51] Louw A. & Leggett T. Parry C.D.H., Plüddemann A. The 3-metros study of drugs and crime in South Africa: Findings and policy implications. *The American Journal of Drug and Alcohol Abuse*, 2004.
- [52] Myers B.J. & Parry C.D.H. Plüddemann A. Surge in treatment admissions related to methamphetamine use in Cape Town, South Africa: Implications for public health. *Drug and Alcohol Review*, 2008.
- [53] McKinsey Quarterly. Interview with Jay W. Forrester on System Dynamics. [http://flow.ph/1/links/files/D-4276-2.McKinsey.Interview-The\\_CEO\\_as\\_Organization\\_Designer.pdf](http://flow.ph/1/links/files/D-4276-2.McKinsey.Interview-The_CEO_as_Organization_Designer.pdf), Online; accessed on 28 March 2015.
- [54] Swanson R.C. and Cattaneo A. et al. Rethinking health systems strengthening: key systems thinking tools and strategies for transformational change. *Health Policy and Planning*, 2012.
- [55] Flood R.L. The relationship of systems thinking to action research. *Systemic Practice and Action Research*, 2010.



- [56] Campbell S. Systems thinking for health systems strengthening. WHO World Health Report. 2008. [http://www.who.int/alliance-hpsr/alliancehpsr\\_overview\\_fr\\_eng.pdf?ua\unhbox\voidb@x\bgroupl\et\unhbox\voidb@x\setbox\@tempboxa\hbox{1\global\mathchardef\accent@spacefactor\spacefactor}\accent91\egroupl\spacefactor\accent@spacefactor](http://www.who.int/alliance-hpsr/alliancehpsr_overview_fr_eng.pdf?ua\unhbox\voidb@x\bgroupl\et\unhbox\voidb@x\setbox\@tempboxa\hbox{1\global\mathchardef\accent@spacefactor\spacefactor}\accent91\egroupl\spacefactor\accent@spacefactor), Online; accessed on 28 May 2014.
- [57] Ramlagan S. and Peltzer K. & Matseke G. Epidemiology of drug abuse treatment in South Africa. *South African journal of psychiatry*, 2010.
- [58] South African Medical Research Council (SAMRC). Average life expectancy in South Africa continues to increase. [www.mrc.ac.za/Media/2015/1press2015.htm](http://www.mrc.ac.za/Media/2015/1press2015.htm), Online; accessed on 8 June 2015.
- [59] Nyabadza F. & Hove-Musekwa S.D. From heroin epidemics to methamphetamine epidemics: Modelling substance abuse in a South African province. *Mathematical Biosciences*, 2010.
- [60] Leischow S.J. and Milstein B. Systems thinking and modeling for public health practice. *American Journal of Public Health*, 2006.
- [61] Leischow S.J. and Best A. et al. Systems thinking to improve the public's health. *American journal of preventive medicine*, 2008.
- [62] SACENDU South African Community Epidemiology Network on Drug Use. Cape town feedback meeting, phase 25. <http://www.mrc.ac.za/adarg/sacendu/sacendureport14.pdf>, Online; accessed on 12 August 2015.
- [63] SACENDU South African Community Epidemiology Network on Drug Use. Cape Town feedback meeting, phase 36. <http://www.mrc.ac.za/adarg/SACENDUpresentations/WesternCapeJodileeErasmus.pdf>, Online; accessed on 12 August 2015.
- [64] SAPS South African Police Service. South African Police Service / Western Cape, Annual Report. [https://www.wcpp.gov.za/sites/default/files/SAP\protect\T1\textsection\\_Ann\\_Rep\\_2012\\_2013%5B1%5D.pdf](https://www.wcpp.gov.za/sites/default/files/SAP\protect\T1\textsection_Ann_Rep_2012_2013%5B1%5D.pdf), Online; accessed on 8 June 2015.

- [65] Department of Police South African Police Service (SAPS). Police station figures per province 2004 to 2014. [http://www.saps.gov.za/resource\\_centre/publications/statistics/crimestats/2014/download/police\\_station\\_figures\\_per\\_province\\_wc1.xls](http://www.saps.gov.za/resource_centre/publications/statistics/crimestats/2014/download/police_station_figures_per_province_wc1.xls), Online; accessed on 31 July 2015.
- [66] Statistics South Africa (Stas-SA). Community Survey Census (2004). <https://www.statssa.gov.za/publications/P0302/P03022004.pdf>, Online; accessed on 31 July 2015.
- [67] Statistics South Africa (Stas-SA). Community survey census (2011). <http://www.statssa.gov.za/publications/P03014/P030142011.pdf>, Online; accessed on 31 July 2015.
- [68] De Savigny D. & Adam T. *Systems thinking for health systems strengthening*. World Health Organization, 2009.
- [69] Leggett T. The sieve effect: South Africa's conviction rates in perspective. <https://www.issafrica.org/uploads/3SA.PDF>, Online; accessed on 1 August 2015.
- [70] Orwa T. Modelling the dynamics of alcohol and methamphetamine co-abuse in the Western Cape Province of South Africa. *Stellenbosch University*, 2014.
- [71] Cabrera D.A. et al. Trochim W.M. Practical challenges of systems thinking and modeling in public health. *American Journal of Public Health*, 2006.