



THE DEVELOPMENT OF EXPERIMENTAL MACHINES IN ORDER TO UNDERSTAND THE DEMANDS OF INCREMENTAL SHEET FORMING OF TITANIUM

G.A. Oosthuizen¹, H. Nortjé^{2, 6}, E.J. Herselman^{3, 6}, G. Akdogan⁴ and N. Sacks^{5, 6}

¹Departement of Industrial Engineering
University of Stellenbosch, South Africa
tiaan@sun.ac.za

²Departement of Industrial Engineering
University of Stellenbosch, South Africa
hnortje@sun.ac.za

³Departement of Industrial Engineering
University of Stellenbosch, South Africa
ejhersleman@sun.ac.za

⁴Departement of Process Engineering
University of Stellenbosch, South Africa
gakdogan@sun.ac.za

⁵School of Chemical & Metallurgical Engineering
University of the Witwatersrand, South Africa

⁶DST/NRF Centre of Excellence in Strong Materials, South Africa
natasha.sacks@wits.ac.za

ABSTRACT

Titanium sheet-metal is extensively used for aerospace and biomedical applications. The diversified customer's demands have created a recent trend towards the small batch production. In this context incremental forming has attained great attention. Therefore, experimental machines are designed and manufactured to simulate the harsh forming conditions. In the fretting machine the combination of a normal force and small vibrations may constitute a wear phenomenon known as fretting wear. The friction and wear properties of the tool, lubrication and work piece materials are tested using the sliding test machine. The steps to evaluate and develop these machines as research tools are illustrated and discussed. The fretting- and sliding machines help to investigate suitable forming tools, forming parameters and lubricant strategies for incremental forming of titanium. It is concluded that these simulation tools provide more efficient and cost effective ways to understand the effects of changing the forming conditions.

1. INTRODUCTION

There is an increase in demand, for the development of agile manufacturing techniques that can easily be adapted to a constant introduction of new products in the market. Incremental sheet forming (ISF) is an innovative and feasible solution for the rapid prototyping and the manufacturing of small batch sheet parts. The process requires a CNC machining centre, a spherical tip tool and a simple support to fix the sheet being formed. Metal spinning, stretch forming and press forming are the common processes in practice to form Ti6Al4V sheet components. Most of the existing forming processes are feasible for large batches. Alternatively, the diversified customer's demands have created a recent trend towards the small-batch production. Therefore, the need for a process to form parts in small-batches should be met innovatively. In this context, incremental sheet forming (ISF) has attained a great attention.

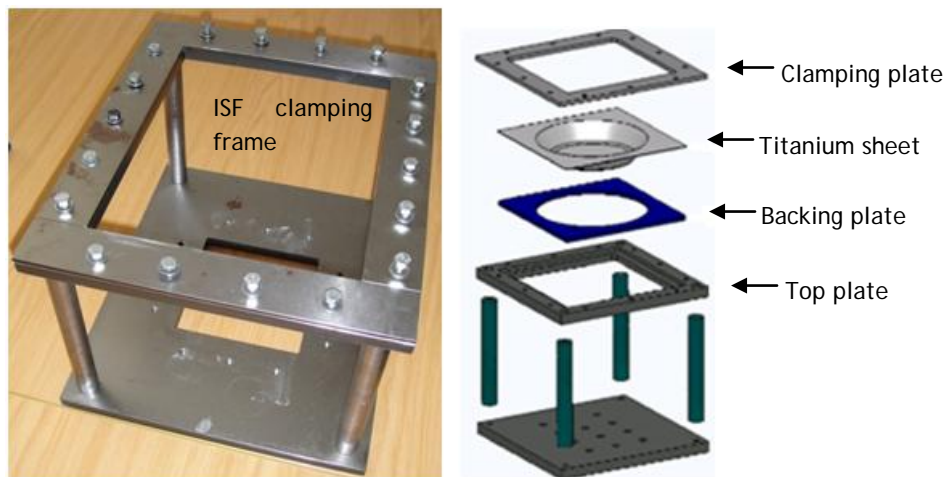

Figure 1: The clamping frame that are used to incrementally form titanium sheet metals

During the process of incremental sheet-metal forming, the contact interface between the sheet-metal and the tool may be subjected to small relative vibratory movements [1]. During this process the sheet-metal is also subjected to a normal force exerted by the tool. This combination of a normal force and small vibrations may constitute a surface degradation phenomenon known as fretting [2].

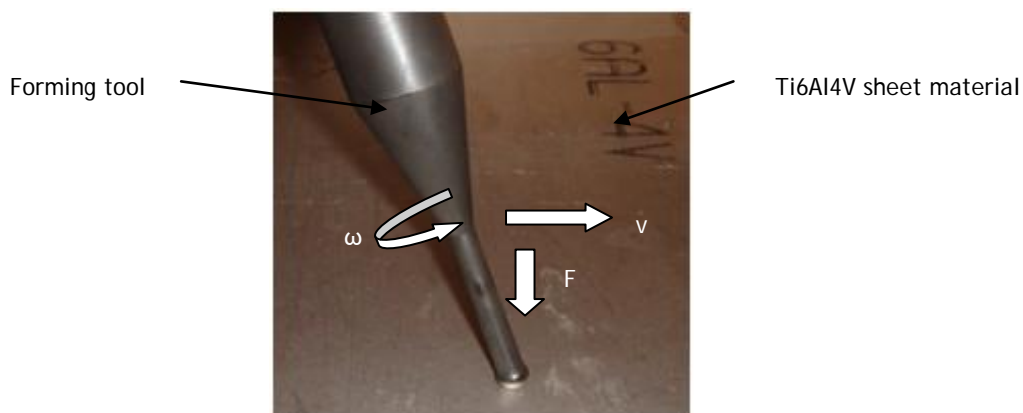

Figure 2: The basic forming parameters for the incremental sheet forming process that can be converted into sliding- and fretting parameters

According to Collins [3] fretting is the mechanical and chemical actions in which the contacting surfaces of two solid bodies are pressed together by a normal force and are caused to execute oscillatory relative sliding motion. In most cases, the oscillatory relative sliding motion is in the tangential direction, perpendicular to the direction of the applied normal force. The fretting process is a synergistic competition among wear, corrosive and fatigue phenomenon [4]. Therefore one of the machines developed and discussed in this paper is a fretting test machine. The aim of this tool is to investigate the conditions at the fretting interface. These conditions include the normal fretting force, the tangential force, the friction coefficient as well as the amplitude and frequency of vibration. Sliding wear takes place if two materials slide over each other that are forced together. This is the most complex form of wear because different materials react differently to the sliding conditions [5]. The paper aims to use a sliding machine to simulate certain conditions at the forming tool tip and sheet metal contact interface to ascertain if certain metal couples are appropriate for ISF.

2. RESEARCH APPROACH

There has been significant development in relation to the technical capabilities of forming processes. At the core of all forming processes is the understanding of the mechanisms of the process. Recent work [6,7] on the tool edge engineering has shown that significant benefits can be obtained by very careful analysis of the precise engagement conditions and of the precise mechanisms underlying its operation. Such an understanding allows us to assess the effectiveness of the energy conversion from the electrical power utilization at the source to its conversion into useful work for the process. It is evident that an understanding of the Ti6Al4V incremental forming operation is a fundamental requirement as input to future models.

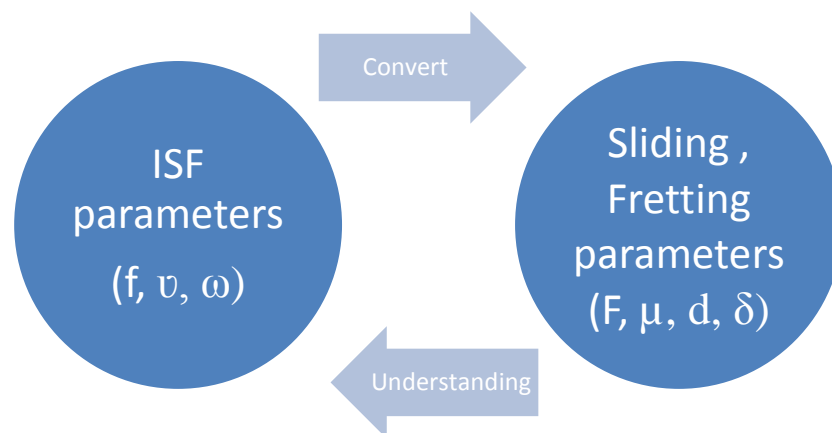

Figure 3: The approach to use sliding- and fretting machine' to test ISF process parameters more rapidly and economically

The incremental sheet forming parameters give certain force measurements, for certain feeds (v), incremental steps (Δz) and tool diameters. These outputs can be used as inputs for the fretting and sliding machine' in order to understand the effects of changing the tool material, tool coating, forming parameters or lubrication strategy. Thereby, costly and time-consuming ISF experiments can be eliminated, while obtaining comparable results from the sliding- and fretting machine'. In the future we can consider non-productive energy and design our systems to reduce or eliminate it. To date there has been little consideration given to evaluating the forming volume/kW of power required. This is a direction that needs a central location on the future roadmap of cutting technologies [8].

3. INCREMENTAL SHEET FORMING PROCESS PARAMETERS

The difference between the different incremental sheet forming processes [9,10,11] is the way the tool moves while deforming the sheet. The spindle could be moved with or without rotating at different spindle speeds. The spindle can also rotate so that the forming tool rolls over the sheet surface. If the tool is stopped, it will slide along the surface of the sheet metal. Heating occurs due to this sliding friction. In contrast, if the tool is rotated at a high speed, the tool surface will slide over the work piece and there will be excessive heating. The relative motion of the surface of the tool, to the surface of the work piece, is directly proportional to the heat generated by sliding friction. These sliding- and rolling friction phenomena can be studied using the sliding and fretting machines. If the relative motion between the tool surface and work piece is small during forming (i.e. all friction is rolling friction, and not sliding friction) the heating is minimized. Most forming tools have a hemispherical shape, which is pressed into the sheet metal to incrementally form the material. Using hemispherical tools there will be an angle, θ , where a point in the sheet is tangent to the hemisphere. This is the location of the maximum diameter of contact (d_{max}). Starting from this point, the sheet will be in contact with the tool down to the very bottom of the sphere, at which point the diameter of contact is zero. Therefore, the average contact diameter is $d_{max} / 2$.

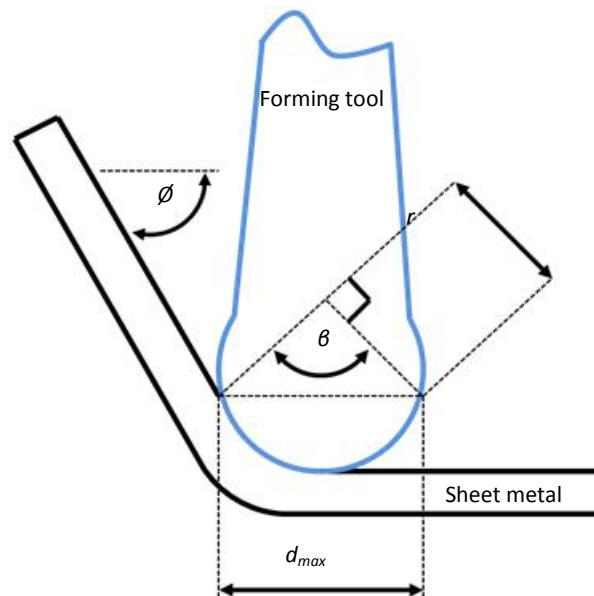

Figure 4: Spindle speed (ω) in terms of feed rate (v), tool radius (r) and wall angle (ϕ)

To keep friction heat minimal the tool must roll over the surface of the work piece as it is formed. This result requires that the distance travelled along the work piece be equal to the average edge of the tool in contact with the material multiplied by the spindle speed. The following equation describes this mathematically. Spindle speed and feed rate are represented by ω and f respectively and the hemispherical tool radius is r as shown in Equation 1.

$$\omega = \frac{v}{\pi \cdot r \cdot \sqrt{\frac{1}{2} \cdot (1 - \cos 2\phi)}} \quad \dots 1$$

The formability increase is due to both a local heating of the sheet and, what is more, a positive reduction of friction effects at the tool-sheet interface. This allows the friction at the tool/work piece to cause the tool to rotate at a speed that automatically matches the

spindle surface rotation speed. Machines specially built for incremental forming use this method [12,13]. Potential users of incremental sheet forming processes are often concerned about the forces that are generated, especially if a CNC milling machine is being used. Research groups have designed special sensors specifically for this purpose, with the results being published recently [14]. In one case, when measuring forces in ISF, a force sensor design was based upon friction measurement work done with cantilever beams [15]. The sensor illustrated in Figure 5 is a spindle mounted cantilever beam with strain gauged Wheatstone bridges. Each bridge is designed to measure one of three orthogonal forces. There are two forces (F_r & F_t) in the bending directions and one (F_a) in the axial direction. Additionally, this sensor can be used for friction measurement studies.

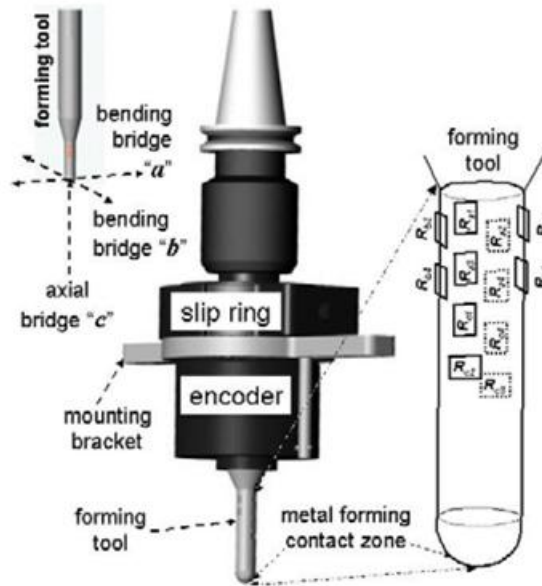

Figure 5: Details of the ISF cantilever sensor design [14]

The force measurement results are shown in Figure 6. Most of the forming energy goes into pushing down shown by the axial force (F_a) and that the resultant (F_b) of F_t and F_r is much lower than F_a .

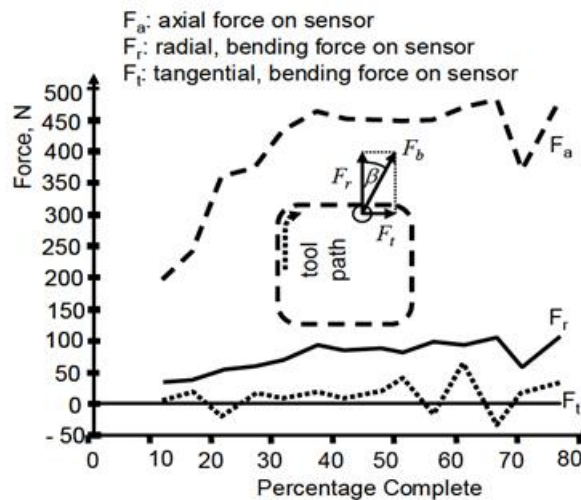

Figure 6: Forces measured in ISF of a pyramid (1.21 mm thick AA 3003-0) [14]

It was concluded [16] that if the vertical step size Δz , tool diameter or wall angle φ , are increased, the total forces on the forming tool, and thus the machine tool, also increase. For these three parameters, the vertical step size has the least significant impact and can therefore be increased without penalty, to reduce part production times. An increase in the tool diameter has a substantial impact on the magnitude of force required to form a given part. Although it can improve surface finish and reduce production time by allowing larger vertical step sizes without affecting surface quality, large increases in tool diameter result in much higher forces and could become a limiting factor. Useful design and simulation information is:

- peak forces can be observed in the area where failure occurs at maximum draw angles, θ_{max} ,
- increasing the vertical step size Δz increases forces
- larger tool diameters increases forming forces

Surface roughness is a major concern in a final product. In ISF the major factor in determining surface roughness is the incremental step size, Δz [17]. In one in-depth study of the effect of pitch, Δz , on surface roughness [17] the objective was to observe which surface roughness indicator was more useful. Figure 7 shows the 3D-figures for different pitch sizes [17].

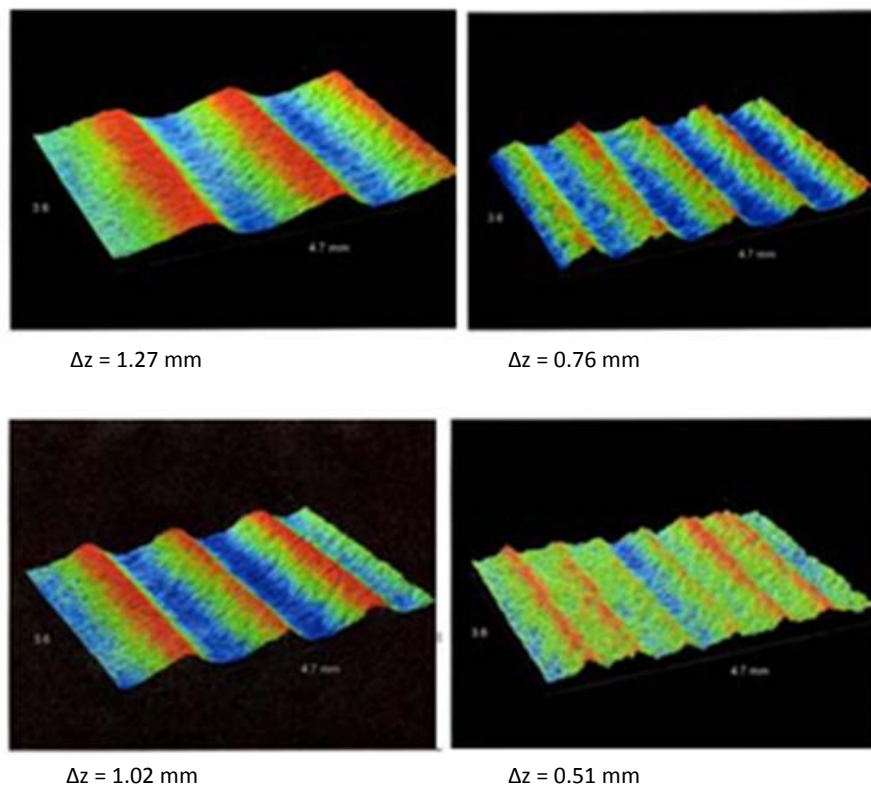

Figure 7: 3D Surface roughness for four pitch (Δz) sizes. Profiles were obtained by white light inter-ferometry and are 3.6 mm x 4.6 mm [17]

There is an unwanted effect of which the designer should be aware. At high draw angles φ there is an orange peel effect [18]. The size of the effect is influenced by the incremental step size, Δx and Δy , and the draw angle, φ . This effect occurs on free surfaces with very large plastic strains and is the result of texture and microstructure effects [19].

4. DESIGN AND DEVELOPMENT OF THE FRETTING MACHINE

The main aim of the Fretting Test Machine is to simulate the fretting phenomenon as closely as possible. According to Dobromirski [2] there are 50 factors that influence the fretting process. These factors include the normal force, slip amplitude, fretting frequency, contact configuration, number of fretting cycles and coefficient of friction at the fretting interface. The developed specifications of the Fretting Test Machine are provided in Table 1.

Specification	Variable	Value
Maximum Slip Amplitude (peak to peak) [μm]	δ	100
Maximum Fretting Frequency [Hz]	f	1000
Minimum Normal Fretting Force [N]	N	10
Fretting Configuration		Ball-on-flat
Number Fretting Cycles		Fully adjustable

Table 1: Design specifications

During operation, the test machine is able to monitor and record the normal force, fretting frequency, slip amplitude and tangential force at the fretting interface.

4.1 Fretting Test Machine

During the conceptual development of the machine, three main driving forces were considered. These driving forces were mechanical-, electrodynamic- and piezoelectric actuation. After careful consideration, piezoelectric actuation was chosen. The Fretting Test Machine was designed with a systems engineering approach in mind. The Fretting Test Machine as a whole is shown in Figure 8.

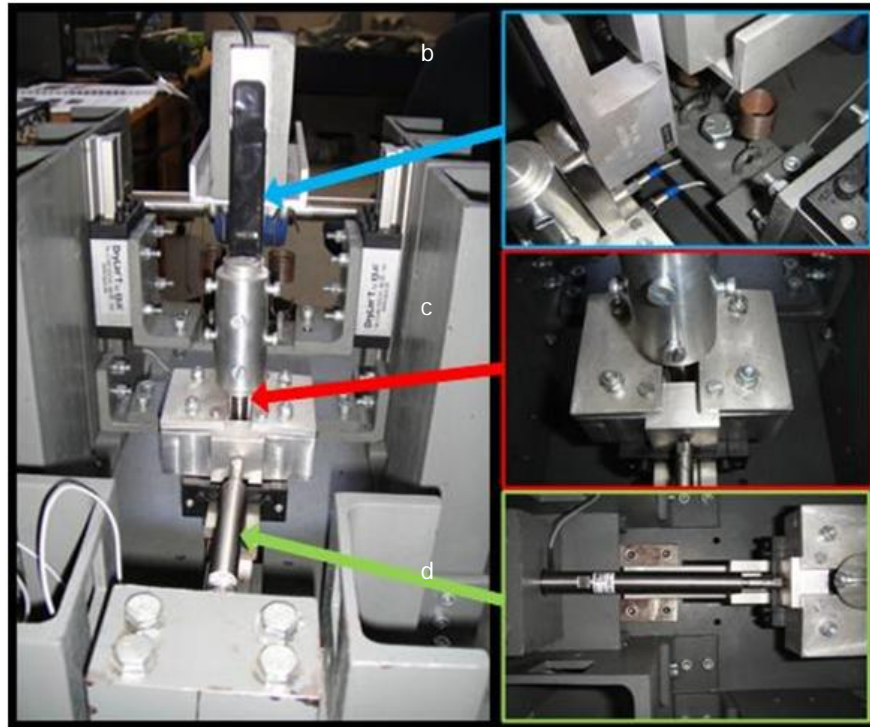

Figure 8: a) Fretting Test Machine; b) Force Application Subsystem; c) Specimen Holder Subsystem; d) Actuating Subsystem

The Force Application Subsystem is responsible for the application and control of the normal force experienced at the fretting interface and houses one of the two test specimens. The subsystem is equipped with two extension springs and an adjustment bolt, for force adjustment and control, as shown in Figure 8 (b). The Specimen Holder Subsystem is responsible for housing the second test specimen. This subsystem combines with the Force Application Subsystem in order to complete the fretting interface as shown in Figure 8 (c). The Actuation Subsystem is responsible for creating the vibratory fretting motion. The heart of this subsystem is a piezoelectric actuator and the subsystem mechanically connects the Specimen Holder subsystem to the rigid structure of the Fretting Test Machine as shown in Figure 8 (d).

Figure 11 is a detailed schematic of the sliding interface. A geared motor is positioned below the machine at an angle of 90° to the tabletop (No. 7 Figure 10). This in turn drives a shaft that connects to a crankshaft at 90° (No. 6 Figure 10). The shaft is linked to the first of two tables that slide on linear bearings. The first table is a simple linkage to the second. The second table holds the flat material (Specimen 1) that is to be tested.

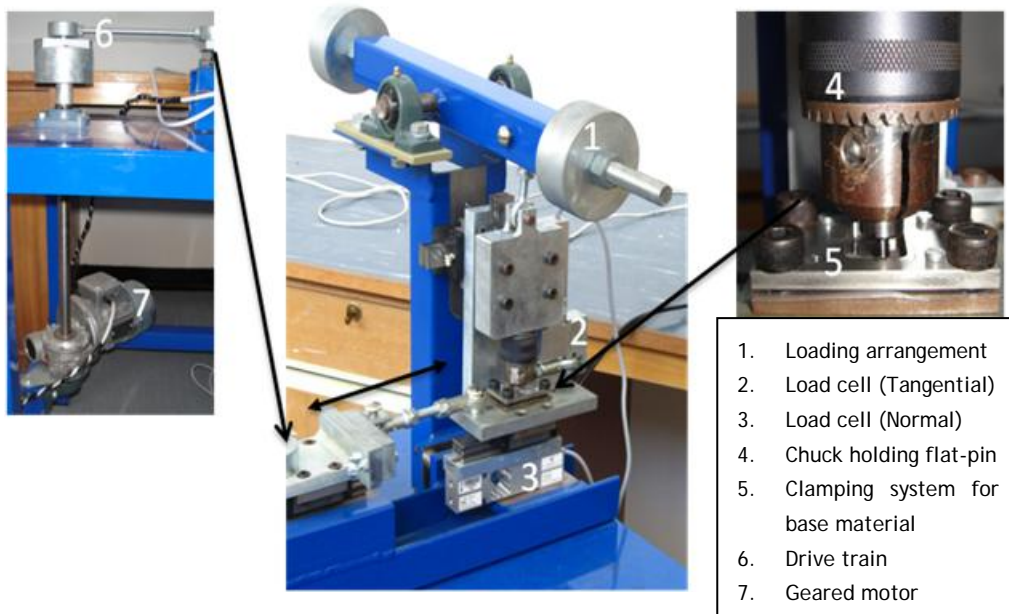

Figure 10: Image sliding test machine to show different parts

Figure 10 (No. 5) and Figure 11 depict the specimen and its holder. Above this table lies a system consisting of a chuck that holds the pin material (Specimen 2), a weight and counter-weight to create a specific normal force. To the side of this system lies a load cell that continuously measures the tangential force (No. 2 Figure 10). Below the second table described lies a second load cell that is used to continuously measure the applied normal load (No. 3 Figure 10).

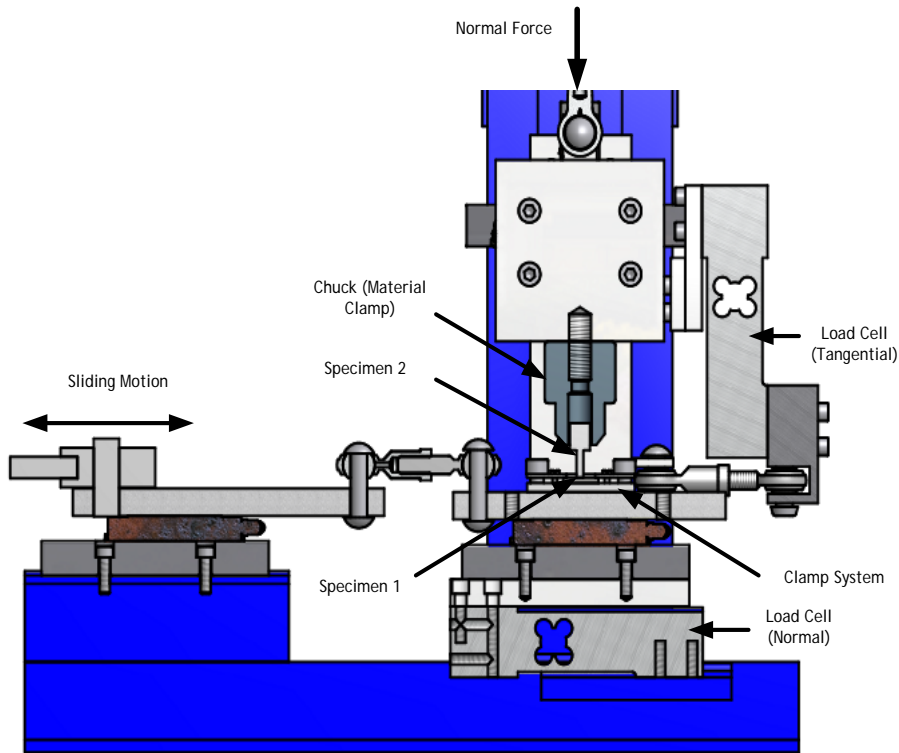

Figure 11: Cross-section view of sliding machine to illustrate the interface

A data acquisition unit is used to read the values of the load cells into the pc. A Quantum MX410 was chosen for this purpose. Different sampling frequencies can be used for the data measurement. Table 2 lists the electronics used on the machine. The load cells are capable of handling a maximum load of 196 N and the speed controller has a maximum of 50 rpm. The speed (rpm) of the motor can be converted to m/s, but the value differs for different sliding amplitudes. The machine is capable of handling various contact configurations.

Type	Manufacturer	Specification	Amount
Motor	Bonifiglioli	EML 220 V, 1370 rpm	1
AC drive	Bonifiglioli	Vectron Synthesis	1
Load cell	HBM	SP4C3 (20kg)	2
Data Acquisition Unit (DAQ)	HBM	Quantum MX410	1

Table 2: Electronic components

Table 3 describes the different parameters on the machine and their minimum and maximum values. The motor speed specified in Table 3 is converted to average sliding velocity (m/s) and this value depends on the peak-to-peak amplitude that is used.

Specification	Variable	Variation
Amplitude (peak-to-peak) [mm]	δ	0 - 35
Normal load [N]	N	0 - 196
Motor Speed [rpm]	ω	0 - 50
Sliding distance	d	Fully adjustable
Sliding configuration		Various

Table 3: Parameter variations

6. EXPERIMENTAL RESULTS AND DISCUSSION

The materials tested during the experimental validation of the Fretting Test Machine and Sliding Wear Test Machine is the titanium alloy Ti-6Al-4V and high speed steel S600. The material properties of Ti-6Al-4V HSS (S600) are provided in Table 4.

Material property	Ti6Al4V	HSS (S600)
Hardness [GPa]	3.21	8.7
Density [g/cm ³]	4.43	8.1
Young's Modulus [GPa]	119	217

Table 4: Material Properties of Ti6Al4V and HSS (S600)

Titanium has a combination of low density and structural strength. It also exhibits excellent mechanical and chemical properties. Despite these properties titanium exhibits poor wear resistance owing to two main factors. The first is its low resistance to plastic shearing and low work hardening. These lead to the material being susceptible to adhesion, abrasion, and delamination wear phenomena. The second factor is the low protection exerted by the surface oxide [20].

6.1 Fretting wear tests

During the experimental validation of the Fretting Test Machine, a Ti6Al4V pin with a hemispherical tip (10mm diameter) was coupled with a 1 mm thick Ti6Al4V plate. Table 5 provides the fretting test parameters used during the experimental validation of the developed Fretting Test Machine.

Experimental Parameter	Variable	Value
Normal Fretting Force [N]	N	40
Fretting Frequency [Hz]	f	40
Slip Amplitude (peak-to-peak) [mm]	δ	100
Number of Cycles		200000

Table 5: Fretting Test Parameters

During the experiment the normal force as well as the tangential force was continuously measured. These measured values provide important information regarding the material couple involved in the fretting process.

Figure 12 provides a graph of the coefficient of static friction of the experiment. Initially the coefficient of static friction increased rapidly from 0.287 and then reached steady state value of approximately 0.35 after 20000 cycles. After 20000 cycles the coefficient of

static friction remained fairly stable. This phenomenon is indicative of fretting wear. The steady reached after 20000 cycles can be explained by the third body wear phenomenon. Accordingly, after 20000 cycles there were wear debris captured within the contact interface, acting as solid lubricant between the two specimen of the original contact interface [21].

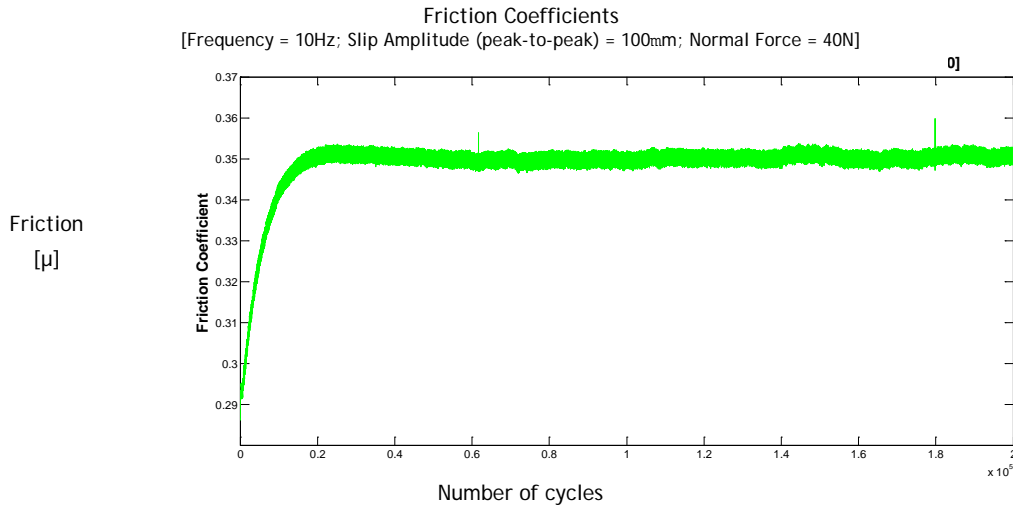

Figure 12: Coefficient of Static Friction

Figure 13 provides two microscope images of the wear scar located on the flat specimen. From the wear scar images it can be deduced that fretting wear has taken place at the contact interface. The dark patches around the outside of the wear scar also provide evidence that a certain degree of oxidation has taken place.

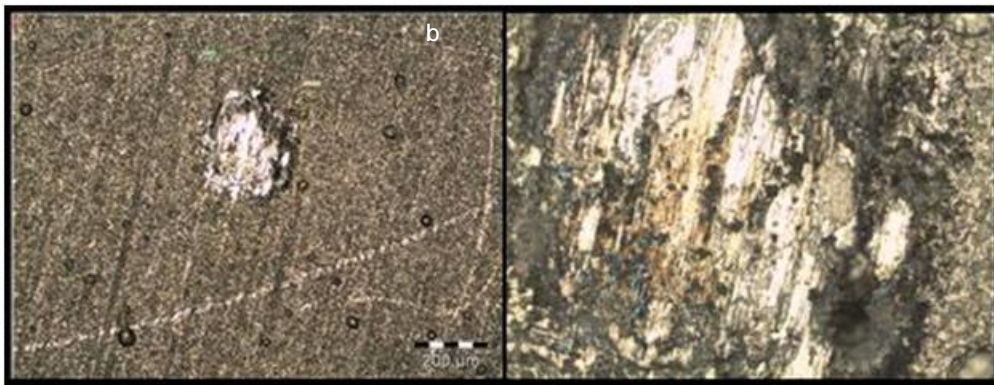

Figure 13: Wear Scar Images at; a) 100 times magnification; b) 500 time magnification

From the validation experiment it can be concluded that the developed test machine is indeed capable of investigating fretting wear conditions, as it relates to incremental forming. The conducted experiment provides useful information regarding the ball-flat-contact typically utilized in incremental forming applications. The coefficient of friction information provided in

Figure 12 also provides a useful measure for decisions relating to the materials couples for incremental forming applications.

6.2 Sliding Wear Tests

Sliding experiments were done to validate the use of the machine. A procedure is followed to be able to see the wear scars on the surface of the material after the sliding wear experiments. For the initial experiments, two materials were chosen. The flat specimen that was chosen was a 1mm Ti6Al4V sheet. The round ended pins were made from two different materials, the first being made from Ti6Al4V and the second from High Speed Steel (S600). The properties of these two materials are listed in Table 4. The experimental parameters are listed in Table 6 and are the same for each contact couple. Equation 2 is used to calculate the Coefficient of Friction (μ). F_T is the tangential force and F_N is the normal force.

$$\mu = \frac{F_T}{F_N} \quad \dots 2$$

Parameter	Variable	Value
Base Material (Specimen 1)		Ti6Al4V (Sheet 1mm)
Pin Material (Specimen 2)		Ti6Al4V/HSS(S600) (5mm Diameter)
Average Velocity [m/s]	v	0.042
Normal Force [N]	N	50
Amplitude (Peak-to-Peak) [mm]	δ	50
Sliding Distance [m]	d	100
Sampling Rate [Hz]	f	600

Table 6: Experimental Parameters

As stated previously two load cells continuously measure the normal- and tangential forces and from this the friction force is calculated using Equation 2. The results are shown in

Figure 14. It can be seen from this graph that that the HSS/Ti6Al4V couple has a lower starting friction and becomes larger. The Ti6Al4V/Ti6Al4V couple starts off higher and then takes a dip and then reaches a state where it is very close to the same values of the previously mentioned couple. In both instances, three-body wear has taken place.

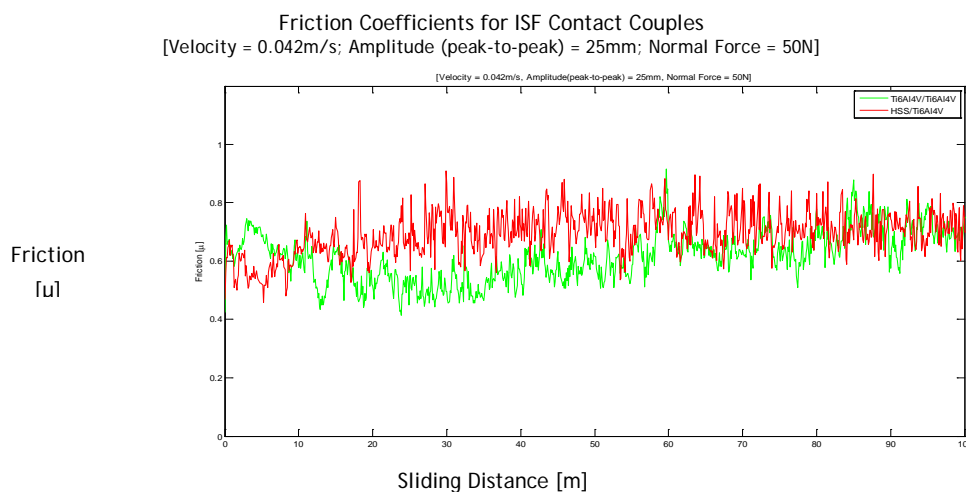

Figure 14: Friction graph for Ti6Al4V and HSS (S600) pin and Ti6Al4V sheet contact couples

Figure 15 depicts the microscope images of the pins and Ti6Al4V sheet metal contact couples after 100m sliding distance. In the instance of the Ti6Al4V / Ti6Al4V couple, the pin wear volume loss was 0.53mm^3 and in the case of the HSS/Ti6Al4V couple, the HSS pin's wear volume loss was equal to 1.62mm^3 . The later pin's wear loss was more than three times greater. The wear can be attributed mainly to abrasive wear, and to adhesive wear to a lesser extent. This can be seen on the microscope images that show gauging on the pins and to a lesser extent on the Ti6Al4V sheet metal.

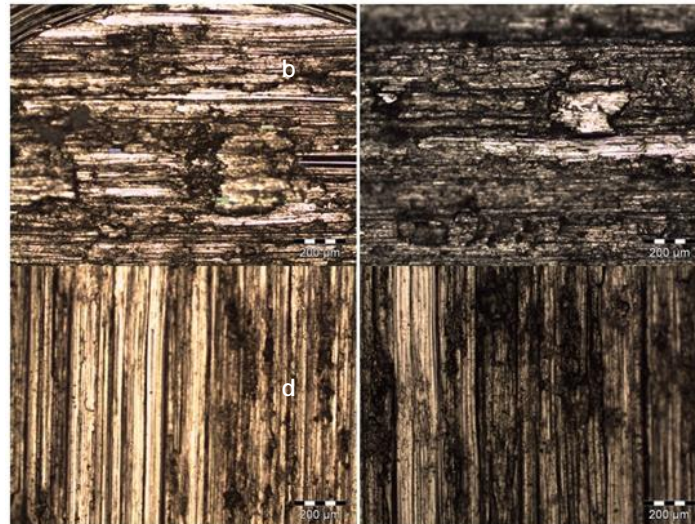

Figure 15: Microscope images of a) Ti6Al4V pin, b) HSS (S600) pin, c) Ti6Al4V sheet coupled with Ti6Al4V pin, and d) Ti6Al4V sheet coupled with HSS (S600) pin after 100m sliding distance (magnification 100X)

Taking all the data into account it can be seen that using a Ti6Al4V/Ti6Al4V couple would be a better option to that of a HSS/Ti6Al4V. This validates the machines performance as sliding machine that can be used in the process to determine materials to be used for incremental sheet metal forming.

7. CONCLUSION

Experimental machines are designed and manufactured to simulate the harsh forming conditions. In the fretting machine the combination of a normal force and small vibrations may constitute a wear phenomenon known as fretting wear. The friction and wear properties of the tool, lubrication and work piece materials are tested using the sliding test machine. The steps to evaluate and develop these machines as research tools are illustrated and discussed. The fretting- and sliding machines help to investigate suitable forming tools, forming parameters and lubricant strategies for incremental forming of titanium. It is concluded that these simulation tools provide more efficient and cost effective ways to understand the effects of changing the forming conditions.

8. REFERENCES

- [1] Jackson, K.P, Allwood, J.M, and Landert, M. 2008. Incremental forming of sandwich panels, *Journal of Materials Processing Technology*, 204, pp 290-303.
- [2] Dobromirski, J.M. 1992. *Variables of Fretting Process: are there 50 of them?*, *Standardization of Fretting Fatigue Test Methods and Equipment*, R B Waterhouse and H Attia, Eds. Philadelphia, USA: ASTM STP 1159.
- [3] Collins, J.A, 1993. *Failure of Materials in Mechanical Design: Analysis, Prediction*,

- Prevention*, 1st ed. New York: John Wiley and Sons, Inc.
- [4] Szolwinski, M.P, and Farris, T.N. 1996. Mechanics of fretting fatigue crack formation, *Wear*, 198, pp 93-107.
 - [5] Pirso, J, Letunovičs, S, and Viljus, M. 2004. Friction and wear behavior of cemented carbides, *Wear*, 257, pp 257-265.
 - [6] Hauschild, M, Jesweit, J, and Alting, I. 2005. From Life Cycle to Sustainable Production: Status and perspectives, *Annals of the CIRP. CIRP Keynote Paper*.
 - [7] Weinert, K. 2004. Dry or near Dry Cutting, *Annals of the CIRP. CIRP keynote paper STCC*.
 - [8] Byrne, G. 2008. High Performance Cutting. An Environmental Perspective, *Proceedings of the 3rd International CIRP High Performance Cutting Conference*, pp 317-327.
 - [9] Leach, D, Green, A.J, and Bramley, A.N. 2001. A new incremental sheet forming process for small batch and prototype parts, *9th International Conference on Sheet Metal*, pp 211-218.
 - [10] Jeswiet, J, and Hagan, E. 2001. Rapid Proto-typing of a Headlight with Sheet Metal, *Proceedings of Shemet*, pp 165-170.
 - [11] Jeswiet, J, and Hagan, E. 2003. A review of conventional and modern single point sheet metal forming methods, *IMECHE part B Engineering Manufacture*, 217(B2), pp 213-225.
 - [12] Amino, H, Lu, Y, Maki, T, Osawa, S, and Fukuda, K. 2002. Dieless NC Forming, Prototype of Automotive Service Parts, *2nd International Conference on Rapid Prototyping and Manufacturing (ICRPM)*.
 - [13] Allwood, J.M, Houghton, N.E, and Jackson, K.P. 2005. The design of an Incremental Forming machine, *11th Conference on Sheet Metal*, pp 471-478.
 - [14] J Jeswiet, J Duflou, and A Szekeres, "Forces in single point and two point incremental forming," *Advanced Materials Research*, vol. 6-8, pp. 449 - 456, May 2005.
 - [15] Nyahumwa, C, and Jeswiet, J. 1991. A Friction Sensor for Sheet Metal Rolling, *Annals of CIRP*, 40, pp 231-234.
 - [16] Duflou, J, Szekeres, A, and Van Herck. 2005. Force Measurements for Single Point Incremental Forming and experimental study, *Journal of Advanced Materials Research*, pp 6-8.
 - [17] Hagan, E, and Jeswiet, J. 2004. Analysis of surface roughness for parts formed by CNC incremental forming, *IMECHE part B, Journal of Engineering Manufacture*, 218(B10), pp 1307 - 1312.
 - [18] Hirt, G, Junk, S, Bambach, M, and Chouvalova, I. 2003. Process Limits and Material Behaviour in incremental sheet forming with CNC-tools, *THERMEC International Conference on Processing & Manufacturing of Advanced Materials Processing, Fabrication, Properties, Applications*, Leganés, Madrid, Spain.
 - [19] Hecker, S.S, and Stout, M.G. 1982. Strain hardening of Heavily Cold Worked Metals, *ASM Materials Science Seminar*, ASM Metals Park Ohio.
 - [20] Molinari, A, Straffelini, G, Tesi, B, and Bacci, T. 1997. Dry Sliding Wear Mechanisms of the Ti6Al4V Alloy, *Wear*, 208, pp 105-112.
 - [21] Trezona, R.I, and Hutchings, I.M. 1999. Three-body abrasive wear testing of soft materials, *Wear*, 235, pp 209-221.
 - [22] Paulin, C, Fouvry, S, and Deyber, S. 2005. Wear kinematics of Ti-6Al-4V under constant and variable fretting conditions, *Wear*, 259, pp 292-299.