

NB-IoT (LTE Cat-NB1 / Narrow-band IoT) Performance  
Evaluation of Variability in Multiple LTE  
Vendors, UE devices and MNOs

by  
Daniel Robinson



Thesis presented in partial fulfillment of the requirements for the degree of  
Masters of Engineering (Research) in the Department of Electrical and  
Electronic Engineering at Stellenbosch University

Supervisor: Prof. M.J. Booysen

March 2020

## Declaration

By submitting this report electronically, I declare that the entirety of the work contained therein is my own, original work, that I am the sole author thereof (save to the extent explicitly otherwise stated), that reproduction and publication thereof by Stellenbosch University will not infringe any third party rights and that I have not previously in its entirety or in part submitted it for obtaining any qualification.

Date: ..... March 2020 .....

Copyright © 2020 Stellenbosch University

All rights reserved.

## Abstract

Cellular 2G/GPRS is a sun-setting technology worldwide leaving behind a void for wireless low-power wide-area-networks (LPWANs) such as LoRaWAN, SigFox and NB-IoT to fill. With NB-IoT on the roadmap towards 5G New Radio (NR), it is a promising contender due to its bidirectionality, power-saving mechanisms and ease of integration with existing equipment, yet there still exists a general uncertainty with regard to adoption. Research shows that most literature on NB-IoT is based on precise mathematical models, analysis or simulations, except for a few empirical performance evaluations which find variability in devices connected to a single network. The study theorizes that networks are responsible for the variation found in metrics and estimations, due to the high underlying complexity of Long-Term Evolution (LTE) architecture on which NB-IoT is based. Thus, the study proposes an empirical investigation using mobile-network operators (MNOs) in South Africa by comparing multiple top LTE vendors including Ericsson and ZTE on MTN's network, and on Vodacom's network Huawei and Nokia. Furthermore, similar user equipment (UE) devices such as Ublox and Quectel are used as a control to observe network changes via RF attenuation. A set of telemetry tests are developed to capture various metrics and estimations into datasets for comparison, which include differently sized UDP packet datagrams, cellular operator selection (COPS), extended discontinuous reception (eDRX) and periodic tracking-area-updates (PTAU). Data is measured using an external energy capture device or reported by the UE device for post-processing and analysis in plots, mean distribution tables and boxplots. Metrics such as latency, power efficiency, signal strength, enhanced coverage level (ECL) classes, throughput and data overhead are included, as well as estimates for telemetry interval periodicity and battery longevity. K-means clustering is applied to the datasets to reduce the skewness induced by the increased number of low-latency values during captures to normalize the number of unique features for comparison.

Most clearly visible in the tests is how MTN leads Vodacom in NB-IoT performance due to Nokia's subpar results. Power efficiency and latency metrics show that when connected to Vodacom-Nokia, results can factor up 20 and 10 times worse, respectively. Otherwise, ZTE, Ericsson and Huawei show satisfactory latency under the 10 second 3GPP standard. Although LTE vendors meet the 164 dBm MCL requirement, Vodacom-Nokia has 10 dB less receive sensitivity, with the rest at -130 dBm. Transmit power increases at 10 dBm per RSRP decade until its maximum at 23 dBm, except for Nokia which remains at full power. ECL classes overlap with respect to RSRP, yet partially correlate, which suggests an unknown network factor or hysteresis of a few seconds in the test captures. Nevertheless, Nokia is mostly in ECL class 1, while others are a mix of ECL class 0 and 1. This has an impact on the number of dynamic repetitions of messages between UE devices and cell-tower eNodeBs. Throughput is under 10 kbps, which is half or less than UE device claims by manufacturers. A quarter of datagrams in the telemetry test set show protocol overhead extending over 512 bytes in uplink and 200 bytes in downlink, except for Nokia extending up to 10,000 bytes. Telemetry interval and battery longevity estimates on a 9.36 Wh AA battery suggest that ZTE, Ericsson and Huawei can transmit 16-512 bytes between every 5 to 30 minutes to last at least a year, or hourly to last up to 10 years, however, a device that transmits hourly on the Vodacom-Nokia network will only last 2 months. The study provides recommendations based on these results.

Finally, South Africa is ready for mobile network operators to deploy national NB-IoT coverage using ZTE, Ericsson and Huawei, but not using Nokia. With a satisfactory inter-cell tower distance, UE devices avoid having to use dynamic repetitions in higher ECL classes, thus keeping the variability that affects many of the metrics and estimates in the study to a minimum.

## Uittreksel

Sellulêre 2G/GPRS is 'n einde-van-leeftyd tegnologie wat wêreldwyd 'n leemte agterlaat, wat deur draadlose lae-krag-wye-netwerke (LPWAN's) soos LoRaWAN, SigFox en NB-IoT gevul sal word. NB-IoT se prominensie op die padkaart na 5G New Radio (NR), maak dit 'n belowende aanspraakmaker vanweë die tweerigtingkommunikasie, kragbesparingsmeganismes en die gemak van integrasie met bestaande toerusting, maar daar bestaan steeds 'n algemene onsekerheid oor die aanvaarbaarheid daarvan. Navorsing toon dat die meeste literatuur oor NB-IoT gebaseer is op presiese wiskundige modelle, analise of simulaties, behalwe vir 'n paar empiriese prestasiebeoordelings wat wisselvalligheid vind in toestelle wat aan 'n enkele netwerk gekoppel is. Hierdie studie stel voor dat netwerke verantwoordelik is vir die variasie in statistieke en beramings as gevolg van die hoë onderliggende kompleksiteit van die Long-Term Evolution (LTE) argitektuur waarop NB-IoT gebaseer is. Die studie stel dus 'n empiriese ondersoek in Suid-Afrika voor, wat gebruik maak van mobiele netwerkkoperateurs (MNO's) en deur verskeie top-LTE-verkopers, waaronder Ericsson en ZTE, op MTN se netwerk en op Vodacom se netwerk Huawei en Nokia te vergelyk. Verder word soortgelyke toestelle vir gebruiker-toerusting (UE) soos Ublox en Quectel gebruik om 'n netwerkverandering via RF-demping te waarneem. 'n Stel telemetrie-toetse word ontwikkel om verskillende statistieke en beramings op te stel in datastelle vir vergelyking, wat verskillende grootte UDP-pakke datagramme, seleksie van sellulêre operateurs (COPS), uitgebreide diskontinue ontvangs (eDRX) en periodieke opdaterings vir opsporing van gebiede (PTAU) insluit. Data word gemeet met behulp van 'n eksterne energie metingstoestel of deur die UE-apparaat gerapporteer vir na-verwerking en ontleding en analises. Maatstawwe soos latensie, drywingseffektiwiteit, seinsterkte, verbeterde dekkingvlakklasse (ECL), deurset data en oorhoofse data is gebruik, sowel as skattings van telemetrie-intervalperiode en batteryleeftyd. K-gemiddelde-groepering word op die datastelle toegepas om die skeefheid wat veroorsaak word deur die verhoogde aantal lae-latenstydwaardes tydens opnames te verminder, om die aantal unieke eienskappe te vergelyk.

Die toetse dui duidelik aan aan hoe MTN se NB-IoT beter vaar as Vodacom s, as gevolg van Nokia se ondergeskikte resultate. Kragdoeltreffendheids- en latenstatistieke toon dat die resultate, as dit met Vodacom-Nokia gekoppel is, onderskeidelik 20 en 10 keer erger kan wees. Andersins vertoon ZTE, Ericsson en Huawei bevredigende vertraging onder die 10 sekonde 3GPP-standaard. Alhoewel LTE-verkopers aan die MCL-vereiste van 164 dBm voldoen, het Vodacom-Nokia 10 dB minder sensitiwiteit, met die ander op -130 dBm. Transmissiedrwing neem toe met 10 dBm per RSRP dekade tot die maksimum op 23 dBm, behalwe vir Nokia wat op volle krag bly. ECL-klasse oorvleuel ten opsigte van RSRP, maar korreleer tog gedeeltelik, wat dui op 'n onbekende netwerk eienskap of histerese van enkele sekondes in die toetsopnames. Nietemin, is Nokia meestal in ECL-klas 1, terwyl die ander 'n mengsel van ECL-klasse 0 en 1 is. Dit het 'n invloed op die aantal dinamiese herhalings van boodskappe tussen UE-toestelle en eNodeBs. Die deurset is minder as 10 kbps, wat die helfte of minder is as wat UE-toestelle se vervaardigers beweer. 'n Kwart van die diagramme in die telemetrie-toetsstel toon die oorhoofse protokol wat strek oor 512 bytes in oplaaikanaal en 200 bytes in aflaaikanaal, behalwe vir Nokia wat tot 10.000 grepe strek. Telemetrie-interval- en batteryleeftydberamings dui daarop dat ZTE, Ericsson en Huawei 16-512 byte tussen elke 5 tot 30 minute kan oordra met 'n 9.36 Wh AA-battery wat minstens 'n jaar sal hou, of uurlikse transmissie wat tot tien jaar sal duur. Toestel wat uurliks op die Vodacom-Nokia-netwerk uitstuur, sal slegs 2 maande duur. Die studie bied aanbevelings gebaseer op hierdie resultate.

Ten slotte, is Suid-Afrika gereed vir mobiele netwerkkoperateurs om die nasionale NB-IoT-dekking te gebruik met behulp van ZTE, Ericsson en Huawei, maar nie Nokia nie. Met 'n bevredigende afstand tussen die toring van die sel, vermy UE-toestelle om dinamiese herhalings in hoër ECL-klasse te gebruik, en sodoende word die veranderlikheid wat baie van die statistieke en ramings in die studie beïnvloed tot 'n minimum beperk.

## Acknowledgements

- **Prof Thinus Booysen** - for unrelenting care, innovative passion, inspiring belief in people and charming charisma.
- **Family** - for love and dedication.
- **Friends** - for wisdoms, experiencing the journey together and sharing moments in highs and lows.
- **MTN Mobile Intelligence Lab** - for providing funding, expertise and laboratory working environment.
- **Ryan van den Bergh** - for driving innovative ideas at MTN.
- **Michael Beetge** - for his expertise in the MTN Phase 3: Test Plant and extensive knowledge of LTE
- **Collin Mamdoo** - for his knowledge on IoT and helpful assistance at Vodacom
- **Helene Lambrechts** - for her aid in coherence and cohesion.
- **RF Design** - for providing samples and development kits.
- **You, the reader** - for reading this thesis. Hopefully it may be of benefit to you, the research community, science, technology, society and beyond!

# Contents

<b>Declaration</b>	<b>i</b>
<b>Abstract</b>	<b>ii</b>
<b>Uittreksel</b>	<b>iii</b>
<b>Acknowledgements</b>	<b>iv</b>
<b>Contents</b>	<b>v</b>
<b>List of Tables</b>	<b>vii</b>
<b>List of Figures</b>	<b>viii</b>
<b>Nomenclature</b>	<b>xii</b>
SI Units	xiii
<b>1 Introduction</b>	<b>1</b>
1.1 Background	1
1.1.1 Why NB-IoT?	1
1.1.2 History and Development	1
1.1.3 Terminology	2
1.2 Project Description	3
1.2.1 Problem Statement	3
1.2.2 Research Objectives	3
1.2.3 Scope of Work	4
1.3 Project Overview	4
1.3.1 MNOs: MTN and Vodacom	4
1.3.2 LTE Vendors: ZTE, Nokia, Ericsson, Huawei	5
1.3.3 UE Device Manufacturers: Ublox, Quectel, Nordic, SimCom	6
1.3.4 Metrics and Estimations: Power, Latency, Secondary and Interval, Longevity	6
1.3.5 Telemetry Tests: UDP, Echo, COPS, eDRX, PTAU	7
1.4 Network Coverage Worldwide	7
1.4.1 Connectivity in South Africa	7
1.5 Thesis structure	8
<b>2 Literature Study</b>	<b>9</b>
2.1 Related Literature	9
2.2 Internet of Things	9
2.2.1 Requirements and Advancement	9
2.2.2 Push-Pull Model and Edge/Fog Computing	11
2.2.3 Satellite IoT	12
2.3 Low-Powered Wide-Area Networks	12
2.3.1 Unidirectional: LoRaWAN and SigFox	13
2.3.2 Bidirectional: NB-IoT and Dash7	14
2.3.3 LPWAN Comparison	14
2.4 Use Cases	16
2.4.1 Smart Metering	16
2.4.2 Actuator Control	16
2.4.3 Asset tracking	17
2.5 A Deeper Look into NB-IoT	17
2.5.1 Development and Present Standing	17
2.5.2 LTE Architecture and SIBs	19
2.5.3 UE Device Hardware	20
2.5.4 Network Registration, RRC Connection and Inactivity Timer	21

2.5.5	Power-Saving Mechanisms: T3324 Active, T3412 PTAU, eDRX,PTW, Release-A . . .	22
2.5.6	Repetitions and Enhanced Coverage Levels . . . . .	23
2.5.7	RF Characteristics, MCL and monitoring network behavior . . . . .	24
2.5.8	AT Commands and Application Architecture . . . . .	25
2.6	Summary . . . . .	27
<b>3</b>	<b>Design and Methodology</b>	<b>28</b>
3.1	Preliminary Tests . . . . .	28
3.1.1	Network Info and Behavior . . . . .	28
3.1.2	Range Field Test . . . . .	31
3.1.3	RF Spectrum Tests . . . . .	35
3.1.4	Power Saving Mechanisms . . . . .	36
3.1.5	Ultra-low Current Sleep Measurements . . . . .	38
3.1.6	Mobility Tests . . . . .	38
3.1.7	Throughput . . . . .	38
3.2	Example Application . . . . .	39
3.3	Setup Procedure . . . . .	40
3.3.1	Hardware . . . . .	40
3.3.2	Network Registration . . . . .	43
3.3.3	PyTest Framework . . . . .	43
3.3.4	Telemetry Tests . . . . .	46
3.4	Primary Metrics . . . . .	51
3.4.1	Power Efficiency . . . . .	51
3.4.2	Latency and Timing . . . . .	54
3.5	Secondary Metrics . . . . .	54
3.5.1	Signal Strength . . . . .	54
3.5.2	Throughput . . . . .	58
3.5.3	Data Overhead . . . . .	58
3.6	Estimations . . . . .	58
3.6.1	Telemetry Interval . . . . .	58
3.6.2	Battery longevity . . . . .	58
3.7	Field Test Captures . . . . .	58
3.7.1	Dataset . . . . .	59
3.7.2	Post-processing . . . . .	60
<b>4</b>	<b>Results</b>	<b>63</b>
4.1	Primary Metrics . . . . .	63
4.1.1	Latency and Delay . . . . .	63
4.1.2	Power Efficiency . . . . .	65
4.2	Secondary Metrics . . . . .	66
4.2.1	Signal Strength Metrics . . . . .	66
4.2.2	Throughput . . . . .	68
4.2.3	Data Overhead . . . . .	69
4.3	Estimations . . . . .	70
4.3.1	Telemetry Interval . . . . .	70
4.3.2	Battery longevity . . . . .	70
4.4	Summary . . . . .	71
<b>5</b>	<b>Conclusion and Recommendations</b>	<b>72</b>
	<b>References</b>	<b>74</b>
	<b>Appendices</b>	<b>77</b>
<b>A</b>	<b>Measured Metric and Estimation Tables</b>	<b>77</b>
A.1	Latency . . . . .	77
A.2	Average Power . . . . .	78

A.3	Telemetry Interval	79
A.4	Battery Longevity	80
<b>B</b>	<b>UE Reported Metric and Estimation Tables</b>	<b>81</b>
B.1	RF Transmit Time	81
B.2	RF Receive Time	82
B.3	Average Power Estimate	83
B.4	Telemetry Interval	84
B.5	Battery Longevity	85
B.6	Signal to Noise Ratio	86
<b>C</b>	<b>Metric and Estimation Plots</b>	<b>87</b>
C.1	Latency	87
C.1.1	Measured latency	87
C.1.2	UE Reported Transmit Latency	89
C.1.3	UE Reported Receive Latency	91
C.2	Power Efficiency	93
C.2.1	Measured Energy Consumption	93
C.2.2	Energy vs Latency	95
C.3	Secondary Metrics	97
C.3.1	Signal Strength	97
C.3.2	Throughput	100
C.3.3	Data Overhead	102
<b>D</b>	<b>Example Application Board and Schematic</b>	<b>107</b>
<b>E</b>	<b>System Information Block (SIB) Examples</b>	<b>110</b>
<b>F</b>	<b>Sierra Wireless WP7702 Test Anomaly</b>	<b>116</b>
<b>G</b>	<b>PyTest Setup Fixtures</b>	<b>117</b>
<b>H</b>	<b>Ericsson eNodeB Managed Objects Snippet</b>	<b>119</b>

## List of Tables

1	Metrics and Estimations	4
2	Telemetry Types, UE devices and LTE vendors	4
3	MNOs and their LTE base station (BTS) vendors in South Africa	5
4	NB-IoT connectivity in South Africa with regard to MNO, LTE vendor and location.	8
5	Unidirectional and bidirectional LPWANs	11
6	Brief comparison of NB-IoT against wireless LPWANs	14
7	Brief comparison of NB-IoT against cellular technologies [29]	15
8	LPWAN strengths with $\checkmark$ , $\times$ denoting best and worst case respectively.	15
9	List of Use Cases	16
10	Configuring the T3412 PTAU Timer. Bits 5 to 1 represent the binary coded timer value. Bits 6 to 8 define the timer value unit for the PTAU timer as follows. See more in 3GPP TS 24.008 [4], figure 10.5.147a and table 10.5.163a.	22
11	Configuring the T3324 Active Timer. Bits 5 to 1 represent the binary coded timer value. Bits 6 to 8 define the timer value unit for the Active timer as follows. See more in 3GPP TS 24.008 [4], figure 10.5.147a and table 10.5.163a.	23
12	Useful AT commands for Ublox, Quectel	25
13	Useful URCs for Ublox, Quectel	25
14	Suggested application power saving modes [2]. It should be noted that the network default for the Inactivity timer remains when registering and on downlink messages.	26
15	System Information Blocks description [44]	28



16	PCI, Cell ID and EARFCN count as a result of registrations with LTE networks. Tuples are in (Ublox, Quectel) format. . . . .	29
17	Table showing a summary of C-DRX values . . . . .	30
18	NB-IoT and LTE Cat-M handover. . . . .	38
19	Table showing preliminary throughput tests for GPRS, NB-IoT and LTE-M . . . . .	39
20	PyTest setup commands to be run in terminal . . . . .	45
21	PyTest telemetry test commands to be run in terminal . . . . .	46
22	Custom libraries imported by Jupyter and a description of their purpose . . . . .	62
23	MCL between LTE vendor-MNO pairs and UE using process defined in §3.5.1.1. . . . .	66
24	Minimum RSRP values for LTE vendors and UE. . . . .	66
25	The table shows the highest RSRP level at which ECL classes transition for LTE vendors, as well as when assuming a base RSRP of -70 dBm for a typical device, the indoor penetration is measured before ECL 2 is reached, which results in deep penetration until disconnection. . . . .	68
26	The table shows the mean latency measurements . . . . .	77
27	The table shows the mean average power measurements ( $\mu Wh$ ) . . . . .	78
28	The table shows the mean telemetry interval estimate (hours) using measured energy values for 9.36Wh AA battery (Lithium Thionyl Chloride) to last 1 year. . . . .	79
29	The table shows the mean longevity estimate (years) for 9.36Wh AA battery (Lithium Thionyl Chloride) with hourly uses. . . . .	80
30	The table shows the mean UE reported transmit time (s) . . . . .	81
31	The table shows the mean UE reported receive time (s) . . . . .	82
32	The table shows the mean average power estimate ( $\mu Wh$ ) . . . . .	83
33	The table shows the mean interval estimate in minutes using reported transmit and receive time in average power estimations for 9.36Wh AA battery (Lithium Thionyl Chloride) to last 1 year. . . . .	84
34	The table shows the mean longevity estimate in years using reported transmit and receive time for 9.36Wh AA battery (Lithium Thionyl Chloride) with hourly uses. . . . .	85
35	The table shows the mean UE reported SINR (dB) . . . . .	86

## List of Figures

1.1	A simplified representation of the transition from 2G to LTE . . . . .	2
1.2	Top LTE vendors in the world showing the worldwide revenue share of VoIP and IMS equipment in 2017. ©Statista, IHS Markit . . . . .	5
1.3	Countries around the world with NB-IoT and LTE-M networks deployed ©GSA, 2019 ©GeoNames, HERE, MSFT, Microsoft, NavInfo, Thinkware Extract . . . . .	7
1.4	NB-IoT coverage in South Africa . . . . .	8
1.5	Vodacom and MTN NB-IoT SIM cards . . . . .	8
2.1	Gartner's 2018 Hype Cycle for ICT in Africa. NB-IoT is high on the list of expectations. . . . .	10
2.2	Gartner's Hype Cycle for Emerging Technologies, 2019. IoT is inextricably linked to at least a third of emerging technologies and also has uses in NB-IoT. . . . .	10
2.3	Exponential growth of IoT is estimated [15]. . . . .	11
2.4	Sigfox RSSI triangulation . . . . .	13
2.5	IoT Wireless Technology Representation [2] . . . . .	18
2.6	LTE classic architecture . . . . .	19
2.7	Examples of different NB-IoT UE modems with A) Ublox Sara N200, B) Quectel BC95, C) Nordic nRF9160, D) SimCom 7020E . . . . .	20
2.8	This diagram shows how current usage decreases depending on eDRX power saving configuration. (Based on SimCom 7020E modem datasheet values.) . . . . .	20
2.9	This diagram shows how current usage across different LTE bands changes depending on output power. . . . .	21
2.10	This diagram shows how current versus transmit power for NB-IoT modems remains stable under 0 dBm and increases exponentially until 23 dBm. . . . .	21
2.11	This diagram shows power saving mechanisms for NB-IoT, including paging windows, eDRX cycles, active timer and PSM mode. . . . .	22

2.12 Typical application example ©Ublox	26
3.1 ECL vs RSRP.	29
3.2 C-DRX timing measurement	30
3.3 Rooftop outside the HF RF lab test	31
3.4 ICMP ping response jitter	31
3.5 Short-range ping tests	32
3.6 Long-range tests map	33
3.7 Long-range ping tests	33
3.8 Long-range ping tests	34
3.9 Long-range ping tests	34
3.10 NB-IoT transmissions on RF spectrum	35
3.11 SigFox and LoRa transmissions on RF spectrum	35
3.12 eDRX tests	36
3.13 Irregular eDRX events	37
3.14 Typical eDRX current profile	37
3.15 This is a PCB application developed as an example.	39
3.16 Dashboard showing communication between NB-IoT PCB and Thingsboard cloud via MQTT with temperature, humidity, push button and downlink buzzer control	40
3.17 The Hewlett Packard attenuators used in this study to change the RF conditions for UE devices against multiple LTE vendors	40
3.18 Block diagram of current consumption setup for SARA-N2 ??	41
3.19 ZXCT1008 high-side current monitor	41
3.20 Hologram worldwide e-SIM	43
3.21 Python PyTest framework written in Microsoft VS Code and test output can be seen in bottom-left window. PlatformIO compiles microcontroller code and uploads via avrdude as can be seen in bottom-right window.	43
3.22 AT+COPS=0 network registration on MTN-ZTE network with lengthy inactivity timer setting of 270s.	48
3.23 An oscilloscope measurement of the Echo test in progress. Notice the four DRX cycles before the second Echo response. Echoes worked successfully every time, and did not take another 2.56 seconds DRX cycle longer than the 10 second delay that the echo server induced.	49
3.24 Ublox (blue) and Quectel (red) energy (J) per datagram as a function of the SINR (dB) as reported by the UE on the MTN-ZTE network limited to 1500 mJ. With the fading colour scheme and range just as in Martinez [2], Fig. 3.24 shows the impact of SNR on energy consumption. As observed in the figure, there is a trend of increasing energy with respect to lower SNR levels and high variability. Unfortunately, the effect of different ECLs is unclear.	51
3.25 Ublox (blue) and Quectel (red) energy (mJ) per datagram as a function of the SINR (dB) as reported by the UE on the MTN-ZTE network. Increasing the range fully and using logarithms in Fig. 3.25, one can see that there is significant overshoot on the MTN-ZTE network. The trend mentioned in Fig. 3.24 continues.	52
3.26 UDP Datagram energy-sizes	52
3.27 Histogram showing peak current corresponding to datagram packets	52
3.28 eDRX Energy histogram	53
3.29 PTAU Energy	53
3.30 Latency per datagram as a function of the SINR (dB) as reported by the UE on the (D) MTN-ZTE and (E) Vodacom-Nokia network respectively. In Fig. 3.30, there is a poor distinction between attenuation zones as the SINR varies throughout the reported RSRP range. Grouping the data according to attenuation decade is important to see the effect of network conditions clearly.	54
3.31 LTE RSRQ and SINR RF Conditions. Tests were completed in good, mid cell and cell edge RF conditions as these would be the most common values in the field showing the typical network characteristics and variation.	55
3.32 RSRP distribution using Ublox and Quectel UE on ZTE-MTN and Nokia-Vodacom infrastructure as well as attenuation and telemetry test set. RSRP and telemetry tests have a relatively even distribution, although RSRP still has about 20 dBm variability per attenuation decade. ZTE signals have higher MCL than Nokia.	55

3.33	RSSI against RSRP for Ublox and Quectel devices (similar, thus combined) on MTN-ZTE (left) and Vodacom-Nokia (right). RSSI has a shorter ‘range’ than RSRP due to transmit power being included, and thus more information can be observed when comparing metrics against RSRP. . . . .	56
3.34	SINR against RSRP for Ublox and Quectel devices (relatively similar for now, thus combined) on MTN-ZTE (left) and Vodacom-Nokia (right). Each attenuation zone shows similar ranges of SINR, thus not as useful as RSRP when comparing other metrics against it. Ideally it should show a more linear relationship, and it is possible that these SINR readings are not accurate and contributing to variations in measured metrics. . . . .	56
3.35	LTE RSRQ reporting range defined from -3. . . -19.5dB . . . . .	57
3.36	RSRQ against RSRP for Ublox and Quectel devices (similar, thus combined) on MTN-ZTE (left) and Vodacom-Nokia (right). . . . .	57
3.37	Visual representation of dataset. Five telemetry tests performed to at least five attenuation zone decades on two UE devices, four LTE vendors and two MNOs in Cape Town and Johannesburg. . . . .	59
3.38	Each telemetry test takes in readings from the external energy capture device and UE reported values and through attenuation zone decades, UEs, LTE vendors and MNOs we extract power efficiency, latency, secondary metrics and estimations. . . . .	59
3.39	Probability estimation on latency histogram sample . . . . .	60
3.40	K-means clustering . . . . .	61
4.1	UE reported and measured latency dataset distribution . . . . .	63
4.2	UE reported and measured latency dataset distribution in ECL class 1 . . . . .	64
4.3	Measured and estimated average power dataset distribution . . . . .	65
4.4	Measured and estimated average power dataset distribution in ECL class 1 . . . . .	65
4.5	UE reported RSRP and SINR for LTE vendors, UE and MNOs. . . . .	67
4.6	UE reported ECL . . . . .	67
4.7	The figure shows RLC and MAC layer throughput for LTE vendors, UE and MNOs. . . . .	68
4.8	Byte size distribution of telemetry test set across different MNOs, LTE Vendors and UE devices . . . . .	69
4.9	Telemetry interval estimation sending 16-512 byte packet payloads in ECL class 1 network conditions. . . . .	70
4.10	Battery longevity estimation sending 16-512 byte packet payloads in ECL class 1 network conditions. . . . .	70
C.1	Measured Latency points (484/1619) against RSRP for ZTE, Nokia. . . . .	87
C.2	Measured Latency points (1082/2169) against RSRP for Huawei, Ericsson. . . . .	88
C.3	TX time points (353/503) against RSRP for ZTE, Nokia. . . . .	89
C.4	TX time points (455/1276) against RSRP for Ericsson, Huawei. . . . .	90
C.5	RX time packets (388/1116) against RSRP for ZTE, Nokia. . . . .	91
C.6	RX time packets (588/1677) against RSRP for Ericsson, Huawei. . . . .	92
C.7	Energy packets (487/1619) against RSRP for ZTE, Nokia. . . . .	93
C.8	Energy packets (1216/2169) against RSRP for Ericsson, Huawei. . . . .	94
C.9	Energy versus latency packets (503/1811) for ZTE, Nokia. . . . .	95
C.10	Energy versus latency packets (661/2201) for Ericsson, Huawei. . . . .	96
C.11	Histogram distribution of SINR. . . . .	96
C.12	SINR versus RSRP packets (389/1619) in comparison (AB) of UE, (C) MNOs, (DE) attenuation zones, (F) UE-MNO boxplots, (GH) test types, (I) and ECLs. . . . .	97
C.13	Transmit powers of packets (204/1597) up to 23dBm against RSRP for ZTE, Nokia. . . . .	98
C.14	Transmit powers of packets (340/2148) up to 23dBm against RSRP for Ericsson, Huawei. . . . .	99
C.15	RLC DL throughput of packets (155/602) against RSRP for ZTE, Nokia. . . . .	100
C.16	Snippet of RLC UL throughput . . . . .	101
C.17	Snippet of MAC DL throughput . . . . .	101
C.18	Snippet of MAC UL throughput . . . . .	101
C.19	TX packet sizes (174/457) up to 1kB against RSRP. . . . .	102
C.20	TX packet sizes (390/1282) up to 1kB against RSRP. . . . .	103
C.21	RX packet sizes (166/504) up to 1kB against RSRP. . . . .	104
C.22	RX packet sizes (305/1177) up to 200 bytes on average against RSRP. . . . .	105
C.23	ACK/NACK packet count (83/385) up to 30, outlier at 80 . . . . .	106
D.1	Quectel BG96 modem schematic . . . . .	107

D.2	SIM card, USB and miscellaneous circuitry schematic . . . . .	107
D.3	Power circuitry, antenna and logic level conversion . . . . .	108
D.4	Murata CMWX1ZZABZ-078 module schematic . . . . .	108
D.5	Atmel ATSAM21G18a microcontroller schematic . . . . .	109
D.6	Top and bottom layout of example PCB . . . . .	109
F.1	Retry transmit signals for the WP7702 when extremely close to the edge of signal strength and outside the 180kHz bandwidth channel. . . . .	116

## Nomenclature

---

<b>3GPP</b>	Third Generation Partnership Project
<b>AMQP</b>	Advanced Message Queue Protocol
<b>AMOS</b>	Advanced Managed Object Script
<b>AT</b>	Attention
<b>BPSK</b>	Binary Phase-Shift Keying
<b>BTS</b>	Base Transceiver Station
<b>CDP</b>	Connected Device Platform
<b>COPS</b>	Cellular Operator Selection
<b>CoAP</b>	Constrained Application Protocol
<b>D2D</b>	Device to Device
<b>DCE</b>	Data Communications Equipment
<b>DL</b>	Downlink
<b>DTE</b>	Data Terminal Equipment
<b>E-UTRAN</b>	Evolved-UMTS Terrestrial Radio Access Network)
<b>EARFCN</b>	E-UTRA Absolute Radio Frequency Channel Number
<b>EARFCN</b>	Extended Absolute Radio-Frequency Channel Number
<b>ECL</b>	Enhanced Coverage Level
<b>eDRX</b>	Extended Discontinuous Receive
<b>eNB - eNodeB</b>	E-UTRAN Node B
<b>GPRS</b>	General Packet Radio Service
<b>ICT</b>	Information and Communications Technology
<b>IoT</b>	Internet of Things
<b>ITS</b>	Intelligent Transportation Systems
<b>IMEI</b>	International Mobile Equipment Identity
<b>IMSI</b>	International Mobile Station Identity
<b>IP</b>	Internet Protocol
<b>LBT</b>	Listen Before Talk
<b>LPWAN</b>	Low-Power Wide-Area-Network
<b>LTE</b>	Long Term Evolution
<b>LTE Cat-NB1/2</b>	Long Term Evolution Narrow-Band Category 1/2
<b>MCL</b>	Maximum Coupling Link
<b>MCS</b>	Message Coding Scheme
<b>MME</b>	Mobile Management Entity
<b>MNO</b>	Mobile Network Operator
<b>MO</b>	Mobile Originated
<b>MO</b>	Managed Object
<b>MQTT</b>	Message Queuing Telemetry Transport
<b>MT</b>	Mobile Terminated
<b>MTC</b>	Machine Type Communications
<b>MTN</b>	Mobile Telephone Network
<b>NLOS</b>	Non-Line-of-Sight
<b>NW</b>	Network
<b>OTDOA</b>	Observed Time Difference Of Arrival
<b>PCI</b>	Physical Channel ID
<b>PDR</b>	Packet Delivery Ratio
<b>PS</b>	Packet Switched
<b>PTAU</b>	Periodic Tracking Area Update
<b>PTAU</b>	Periodic Tracking Area Update
<b>QXDM</b>	QUALCOMM eXtensible Diagnostic Monitor
<b>RAN</b>	Radio Access Network
<b>RRC</b>	Radio Resource Control
<b>SF</b>	Spreading Factor
<b>SIM</b>	Subscriber Identity Module

---

<b>SMS</b>	Short Message Service
<b>SNR</b>	Signal to Noise Ratio
<b>TCP</b>	Transmission Control Protocol
<b>TE</b>	Terminal Equipment
<b>UDP</b>	User Datagram Protocol
<b>UE</b>	User Equipment
<b>UL</b>	Uplink
<b>UMTS</b>	Universal Mobile Telecommunications System
<b>URC</b>	Unsolicited Result Code
<b>USSD</b>	Unstructured Supplementary Service Data
<b>UUID</b>	Unique User Identification
<b>WAP</b>	Wireless Application Protocol

---

## SI Units

- **kB, MB** - kilobyte, megabyte
- **kbps** - kilobits per second
- **mJ or J** - millijoules or joules
- **s, ms, us** - second, millisecond, microsecond
- **uWh, mWh** - average power in micro/milliwatt-hours
- **dB** - decibel
- **dBm** - decibel milliwatt
- **MHz, GHz** - megahertz, gigahertz

# 1 INTRODUCTION

---

## 1 Introduction

Narrowing the spectrum bandwidth for cellular Long Term Evolution (LTE) used in everyday life results in a low data-throughput and low energy technology which matches the requirements for wireless Internet of Things (IoT), hence the name “Narrow-band IoT” (NB-IoT).

This chapter introduces various concepts relating to NB-IoT and the performance characteristics thereof. It begins with the question “Why NB-IoT?” before developing the research question, objectives, scope, terminology, background and other various related concepts to fully orientate the reader with regards to NB-IoT.

### 1.1 Background

In recent years, the 3rd Generation Partnership Project (3GPP) developed new low-powered wide-area networks (LPWANs) for the cellular industry on the roadmap towards 5G, namely LTE Cat-M, EC-GSM-IoT and NB-IoT to supersede the sun-setting 2G/GSM/GPRS networks.

#### 1.1.1 Why NB-IoT?

As aforementioned, NB-IoT fills the role 2G/GPRS leaves behind as countries around the world schedule its departure. The LTE-based technology shows performance benefits over alternative LPWANs in terms of up and downlink throughput, range and longevity, yet current research shows that variation in energy consumption leaves battery longevity in question. Nevertheless, according to 3GPP specifications and manufacturer claims, highlights include:

- ~ 10 year battery-lifetime.
- Under 10 second transmission acknowledgement for latency-tolerant applications
- + 20 dB improvement over 2G/GPRS via enhanced coverage levels (ECL).

Despite these highlights, it would nevertheless be significant to further investigate variation in energy consumption, latency, signal strength and battery longevity of the technology to solidify the robustness of these claims both on the sides of user equipment (UE) and network vendors. Other metrics such as throughput, data overhead and estimated telemetry interval would show the effect of network characteristics on the technology.

#### 1.1.2 History and Development

The beginnings of these new cellular LPWANs started when GSM was first deployed in 1991 and offered calls and SMS as circuit switched data. In 2000, 2G/GPRS added internet at speeds comparable to dialup as packet switched data. Circuit switched data is ideal for real-time connections and means that links have bandwidth pre-allocated. This also increases the QoS guarantee of information transferred timeously. Packet switched data is connectionless on the other hand, with higher bandwidths possible in shared channels. In Fig. 1.1, we see how technologies using 2G/GSM/GPRS transitioned to LTE. With regard to using the ‘internet’ for communication, emails, WAP and other ‘web-based’ forms of messaging were used to keep in touch. Over time, we moved to a plethora of IMS platforms such as WhatsApp, Telegram and WeChat to name a few. Machine-to-machine (M2M) is the direct exchange of information without human intervention, both wired and wirelessly. Whilst the world has come a long way from its analog roots such as the telephone, cellular M2M emerged in 1995 with Siemens creating a GSM module for machines to use wireless networks. Even to this day, SMS, USSD and 2G/GPRS is still used, but with the advent of LPWANs we have even more to choose from including LoRaWAN, SigFox and cellular-based forms such as NB-IoT.

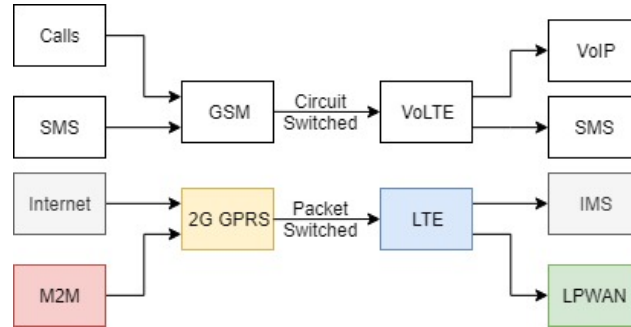


Figure 1.1: A simplified representation of the transition from 2G to LTE with regard to technologies that keep people and ‘things’ in contact. Red-orange-blue-green indicates the path that M2M took through the cellular industry linking it to LPWANs. Grey for internet-based communications and white for circuit-switched.

In South Africa, there is a push by cellular service providers to adopt a cellular LPWAN to fill the void that 2G/GPRS leaves behind now and in the future. NB-IoT is being investigated by MTN South Africa, and since they are also funding this research, have also provided network coverage for testing to Stellenbosch University. Ideally, the technology can be rolled out to existing base stations as a software upgrade for national coverage, but it is limited by factors such as use case demand, expensive licensing and general uncertainty about the technology.

2G/GPRS has served as the gateway for smart devices and sensors in the M2M sphere for many years, but due to its high-powered usage it is not sustainable for applications which require battery longevity of up to 10 years or more. In lieu of its absence, although the spectrum it held can be re-farmed for cellular LPWANs, it also opens up opportunities for market entrants of unlicensed frequencies such as LoRaWAN and SigFox. Each LPWAN technology has its own unique flaws and benefits and there is yet to be a clear winner when it comes to connecting ‘things’ to the internet [1].

When considering rolling out more coverage, since NB-IoT is based on LTE, it makes integration and upgrading of existing infrastructure more seamless than an entirely separate technology. Although NB-IoT still retains the drawbacks and complexities of legacy LTE such as the vast array of sub-protocols and communication overhead, this still includes the low power, low bandwidth benefits and others which match the requirements for smart devices and IoT. It should be mentioned that much of the RF spectrum which can be used for digital communications is still used by analogue television broadcast in South Africa by the SABC. ICASA, who controls the spectrum, can solve this issue but over the years they have been a strong limiting factor in the slow release of new spectrum to large mobile-network-operators (MNOs). This has been the case for approximately 14 years to date, and ICASA has instead released spectrum to smaller players such as Rain Ltd, Liquid Telecom and Telkom. To increase demand for application developers in IoT, because they will be interested in a hands-on approach with the technology they will use, more network coverage is necessary to scale up production such that volumes of 1000 devices or more can be connected.

### 1.1.3 Terminology

Because the nature of this thesis provides many broad concepts and complex terms, this section briefly introduces to the reader various IoT, LPWAN and LTE related topics expanded upon in the rest of the thesis. The background of NB-IoT is discussed in §1.1.

The Internet of Things (IoT in §2.2) is a blanket term for smart devices that connect to the internet. These devices are typically found in remote or urban areas where it would be more efficient for a device to control and monitor the status of the surrounding environment than human intervention.

Smart devices or ‘things’ can connect to the internet by wire or wirelessly. Wired devices usually connect using ethernet, although it is not uncommon to use industry grade protocols such as RS232, CAN, ModBus, Proffibus, and so on before data reaches a network hub and the internet. Wireless connections, on the other hand, have the benefit of easy installation and really shine in inaccessible areas. It is quite effective to connect Bluetooth and WiFi for short range applications, or using Low Powered Wide Area Networks (LPWANs in



§2.3) such as LoRaWAN, SigFox and NB-IoT for ranges exceeding a few kilometers and especially for limited sources of power.

Considering how LPWANs usually fill niche applications and just looking in terms of modulation differences, Long-Range Radio (LoRa or LoRaWAN in §2.3.1) uses chirp-spread-spectrum (CSS) modulation to make it quite immune to doppler effect motion and SigFox (§2.3.1) uses binary phase-shift keying (BPSK) in an ultra-narrow band, which increases noise immunity, but devices cannot move more than 6 km/h. LPWANs enable many use cases (§2.4) such as remote sensing, actuator control and asset/location tracking.

GSM and GPRS fall under 2G and 2.5G which started development in the early 90s. Data transmission (such as USSD, SMS, WAP, IP) is circuit-switched over GSM, and packet-switched over GPRS. Circuit switched data is billed per time interval such as seconds or minutes, and packet-switched is charged per number of bytes (kB, MB, etc.). It evolved into 3G in Release 99 at the turn of the millenium and 4G/LTE in Release 8 (Q4 2008).

Long Term Evolution (LTE) is a cellular broadband technology that is a subset of an even more complex 3GPP governing body that guides its development. In LTE, the narrowband category is known as LTE Cat-NB or NB-IoT. LTE Cat-M is designated for M2M applications, and although it is quite similar to NB-IoT, it features VoIP, faster throughput and is more similar to the LTE protocol. Unfortunately it is not considered in South Africa. There are two different versions of NB-IoT, with LTE Cat-NB1 being release 13 and LTE Cat-NB2 being release 14. Their specifications have been frozen in Q1 2016 and mid-2017, respectively, with LTE Cat-NB1 in South Africa.

## 1.2 Project Description

### 1.2.1 Problem Statement

NB-IoT has unique features that hold a competitive advantage over alternatives such as LoRaWAN, SigFox and other LPWANs, however it does not have a strong uptake in South Africa yet. Most notably, NB-IoT offers energy efficient bidirectionality (as opposed to the uplink-centric norm) using extended discrete periodic reception (eDRX), yet variation in transmission energy and latency can affect battery lifetime drastically. Application developers require network coverage before they are interested in developing business cases, and cellular service providers require consumer and enterprise demand or business cases before rolling out national network coverage. This creates a paradoxical situation where neither party gives in unless they are both willing to come to a compromise. Such efforts can be limited by a lack of understanding in the technology, and this is not helped by the fact that although there is a great deal of theoretical analysis and simulations in research, the lack of empirical evidence may be contributing to a general uncertainty in the standing of the technology with respect to alternatives and thus a slower adoption. This thesis aims to bridge that divide in South Africa by evaluating NB-IoT's performance empirically using a set of metrics and estimate optimal use.

### 1.2.2 Research Objectives

This study has the following aims:

- Latency, power efficiency and other metrics of NB-IoT are to be evaluated using a set of telemetry tests.
- User equipment (UE) devices will be compared against multiple LTE vendors used by mobile network operators (MNOs) exposing the change in variability due to proprietary LTE complexities.
- Battery longevity and recommended telemetry intervals are estimated, and other secondary metrics such as signal strength, throughput and data overhead are investigated.

In turn, the above objectives evaluate the robustness, stability, capabilities, sources of variability and claimed versus actual core features of NB-IoT.

This thesis aims to highlight the advantages, disadvantages and challenges of NB-IoT. By doing endpoint tests between UE devices and multiple LTE base station vendors, one can paint an accurate picture of the capabilities of the technology as rolled out in South Africa.

### 1.2.3 Scope of Work

Although there exists a multitude of UE devices, LTE vendors, estimations and metrics, the study will be limited to the following as seen in Table 1 and 2.

While theoretical models provide value in showing how factors affect an approximation, the boundless underlying complexities of LTE architecture make it hard to predict the variability induced by unpredictable network conditions. Thus, an empirical approach is proposed. Since the energy efficiency of a single network is already in question by the results generated by Durand [1], Martinez [2] and affected by latency, these will form the main metrics investigated in this study.

Table 1: Metrics and Estimations

Main Metrics	Secondary Metrics	Estimations
Power Efficiency	Signal Strength	Battery Longevity
Latency	Throughput	Telemetry Intervals
	Data Overhead	
	Coverage Levels (ECLs)	

Table 2: Telemetry Types, UE devices and LTE vendors

Telemetry Types	LTE Vendors	UE Manufacturers
UDP Packets	ZTE	Ublox
eDRX and PTAU	Nokia	Quectel
COPS	Ericsson	(Nordic)
Data Echo	Huawei	(SimCom)

The capture method should be easily repeatable and expandable for new UE devices. On the basis that the AT command API is familiar to all UE devices, a framework will be built to extract data via this method. Although all UE devices are usually accessible through AT commands, there are alternative diagnostic methods such as Qualcomm QXDM, UEMonitor and an opensource decoder by LanternD which monitors the debug stream provided over UART at 921600 baud. QXDM is a proprietary diagnostic program built for UE devices with Qualcomm chipsets, yet it costs in excess of a few thousand USD. UEMonitor is free and can capture debug traces from both Ublox and Quectel. LanternD's decoder is still in beta and thus unstable. Since both Ublox and Quectel's debug messages can be accessed by UEMonitor and LanternD, these UE devices will be used to compare LTE Vendors. There is no support or alternative for Nordic or SimCom devices, however.

## 1.3 Project Overview

This section looks at how user equipment (UE devices in §1.3.3) is compared against multiple LTE vendors (§1.3.2) operated by mobile network operators (MNOs in §1.3.1) which expose the change in variability due to proprietary LTE complexities. These comparisons are made according to a set of metrics, estimations (§1.3.4) and telemetry tests (§1.3.5).

### 1.3.1 Mobile Network Operators

The following MNOs have NB-IoT coverage in South Africa which will be expanded upon in §1.4, namely MTN and Vodacom. NB-IoT uses their LTE infrastructure, and this will be expanded upon in §1.3.2.

MTN Group Limited and Vodacom Group Limited are both mobile telecommunication companies trialing the use of NB-IoT in South Africa. While they are both based in South Africa with headquarters in Johannesburg,

MTN operates in many African countries and the Middle East, and Vodacom is part of the International Vodafone Group with over 55 million customers.

### 1.3.2 Long Term Evolution (LTE) Vendors

Table 2 gives the following LTE vendors which are among the top 5 in the world: Huawei, Ericsson, Nokia and ZTE. Since there are over a hundred MNOs across the world which also use these LTE vendors, performing this study on the main LTE vendors will also benefit the MNOs. With regard to NB-IoT connectivity on MNOs in South Africa, MTN will be used for ZTE and Ericsson, and Vodacom will be used for Nokia and Huawei.

In South Africa, there are two mobile network operators trialing NB-IoT and combined they use four of these top LTE vendors. Samsung has started using NB-IoT only as recently as May 2019, announcing a partnership with KT to create a Public Safety (PS-LTE) network. They're also implementing device-to-device (D2D) communications to increase connectivity in unfavourable conditions.

Table 3: MNOs and their LTE base station (BTS) vendors in South Africa

BTS Vendors	Cellular operator (MNO)
Nokia	Vodacom
ZTE	MTN
Huawei	Vodacom
Ericsson	MTN

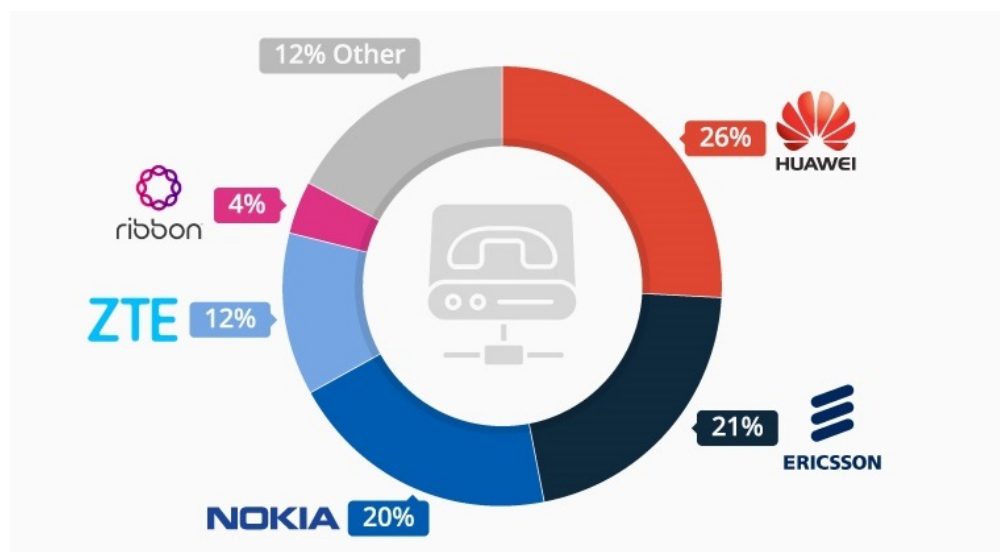


Figure 1.2: Top LTE vendors in the world showing the worldwide revenue share of VoIP and IMS equipment in 2017. ©Statista, IHS Markit

ZTE, Nokia, Ericsson and Huawei are all multinational telecommunication, equipment, systems and consumer electronics companies, with:

- ZTE Corporation and Huawei Technologies Co. Ltd. were founded in 1985 and 1987 respectively, and are both headquartered in Shenzhen, Guangdong province, China.
- Nokia Corporation, founded in 1865, is headquartered in Espoo, Helsinki, Finland.
- Telefonaktiebolaget LM Ericsson, founded in 1876, is headquartered in Stockholm, Sweden.

Theoretically, one can assume that these manufacturers meet 3GPP's specifications. With a more rigorous

testing framework, one can evaluate these capabilities in a transparent manner for both developers and cellular operators alike and work towards improving the quality thereof.

Other vendors include: Cisco Systems, Sierra Wireless, Intel Corporation, Samsung Electronics, Telit Communications, Saudi Telecom Company, Oberthur Technologies, Broadcom Corporation KDDI Corporation, LG Electronics, Gemalto NV, VimpelCom, MediaTek, Ooredoo, and Orange.

### 1.3.3 UE Device Manufacturers

Finally, with regard to the UE devices in 2, application developers are likely to use more popular NB-IoT module manufacturers such as Ublox, Quectel, Nordic and SimCom, besides lesser known ones such as Telit, Sierra Wireless, Gemalto, and akorIoT.

UE devices specifically used:

- Ublox Sara N200
- Quectel BC95

and the following recommended in future:

- Nordic nRF9160
- SimCom SIM7020E
- Mediatek MT2625
- Sierra Wireless 7702

Although LTE vendors are open to all UE manufacturers, mobile network operators (MNOs) are still in control of LTE vendor equipment and some aspects of UE devices via RF signalling. Thus it is important for MNOs to recognize the effect they have on the technologies they use, especially when it differs from theory. UEs devices typically use AT commands as the API to control their capabilities.

These UE device manufacturers are considered:

- Ublox, founded in Switzerland, 1997, is a fabless semiconductor company that creates user equipment for telecommunications in consumer, automotive and industrial markets, and leads in GNSS.
- Quectel, founded in China, 2010, is a comprehensive supplier of user equipment for the cellular industry, with a wide range of modems covering 5G, LTE, NB-IoT/LTE-M, UMTS/HSPA+, GSM/GPRS and GNSS; it leads in production of UE modems, but not GNSS.
- Nordic Semiconductor, founded in Norway, 1983, is a fabless semiconductor company specializing in ultra-low power Bluetooth low energy (BLE) and 2.4 GHz devices, as well as the low-powered cellular industry (NB-IoT/LTE-M).
- SIMCom Wireless Solutions, founded in China, 2002, is a wireless M2M company offering a variety of wireless modems based on GSM/GPRS, WCDMA/HSDPA, TD-SCDMA and NB-IoT/LTE-M.

### 1.3.4 Metrics and Estimations

Considering metrics and estimations in Table 1 above, a more comprehensive study has been performed on throughput, packet delivery ratio (PDR), maximum coupling link (MCL) and scalability by Durand [1]. Martinez has investigated the performance boundaries of NB-IoT for a Vodafone network in Barcelona, Spain [2] including metrics such as energy consumption, transmission delay, enhanced coverage levels (ECLs) and different data sizes. Because power efficiency and latency is significantly affected by variability, important considerations have to be made in application development and thus it is of the main metrics this study is focused on. Between UE devices and LTE base stations (BTS) both signal strength (RSRP) and coverage enhancement levels (ECL) can be causes of variability.

In terms of estimations, variability affects battery lifetime and telemetry interval amongst others. Battery lifetime is defined as the length of time a device will last on an AA battery in years. Telemetry interval is defined as the periodicity time between different types of messages to last a year on an AA battery. These two estimations are necessary for developers to consider in battery-powered applications and form an important basis for this study.

### 1.3.5 Telemetry Tests

The different types of telemetry messages in Table 2 include UDP datagram transmission, cellular operator selection (COPS), UDP Echo, extended discontinuous reception (eDRX) and periodic tracking area updates (PTAU). UE devices usually give the option of using the following main data transmission protocols: UDP, TCP, CoAP and MQTT. UDP is a connectionless protocol used for low latency applications and TCP is used to stream data orderly, reliably, but at a cost to data overhead. CoAP and MQTT are lightweight message transfer protocols based off of UDP and TCP respectively. To measure the data overhead secondary metric caused by network repetitions and other mechanisms, it would be preferable to avoid overhead from other protocols and thus the simplest option is chosen, namely UDP.

## 1.4 Network Coverage Worldwide

Although NB-IoT joined LPWANs circa 2016-2017, world-wide coverage is still growing. This can be seen in Fig. 1.3. AT&T announced nation-wide coverage of NB-IoT in the USA, alongside its existing LTE Cat-M coverage. Deutsche Telekom and Vodafone cover Europe and China enables millions more IoT devices [3].

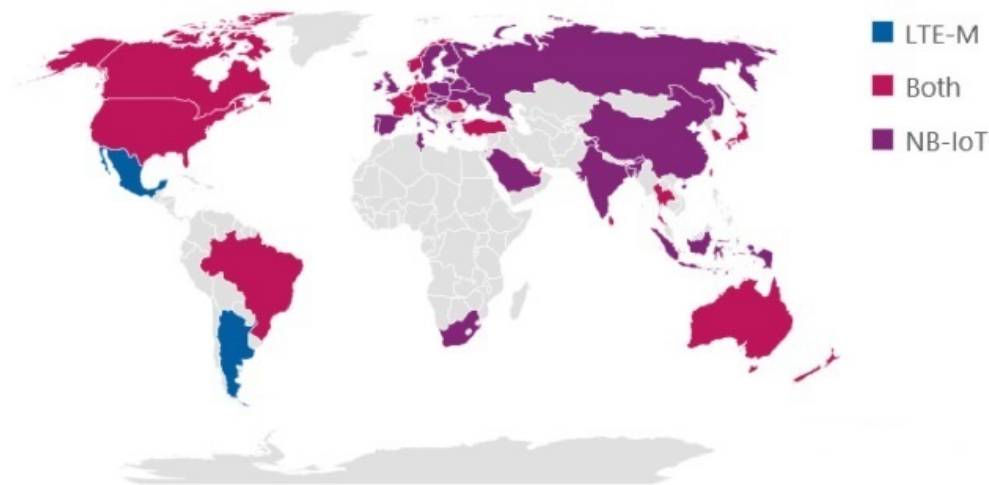


Figure 1.3: Countries around the world with NB-IoT and LTE-M networks deployed ©GSA, 2019 ©GeoNames, HERE, MSFT, Microsoft, NavInfo, Thinkware Extract

### 1.4.1 Connectivity in South Africa

In South Africa, NB-IoT has most of its coverage in the Gauteng province as well as a few sites in other towns and cities. Although Gauteng only covers 1.49% of the landmass in South Africa, it holds ~22% of its ~57 million people so understandably it is great as a live trial run before pushing for national coverage.

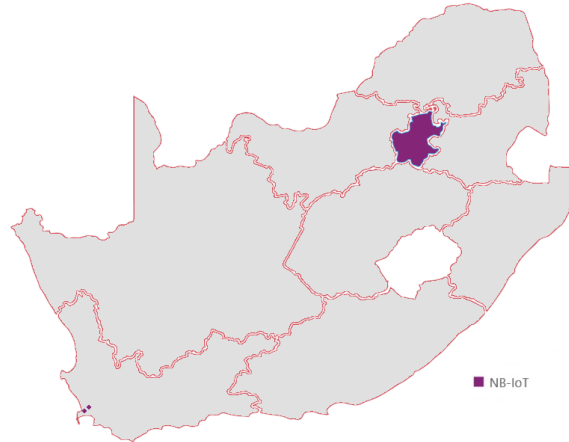


Figure 1.4: NB-IoT coverage in South Africa

Table 4: NB-IoT connectivity in South Africa with regard to MNO, LTE vendor and location.

MNO	LTE Vendor	Location
MTN	ZTE	Stellenbosch
Vodacom	Nokia	Vodacom Head Office, Cape Town
MTN	Ericsson	MTN Phase 3: Test Plant
Vodacom	Huawei	Gauteng Province

To connect via NB-IoT on the Vodacom network, sim cards must be purchased with an M2M contract over 24 months at 5.00 ZAR/month. At the time of registering in this study, data bundles range from 5 Mb for 7.50 ZAR to 30 Mb for 29.00 ZAR.

MTN NB-IoT sim cards can currently be obtained only for testing purposes, and it would be best to speak directly to MTN.



Figure 1.5: Vodacom and MTN NB-IoT SIM cards

## 1.5 Thesis structure

NB-IoT is introduced to the reader in Chapter 1. A literature study reviews the current empirical research in Chapter 2. Design and methodology shows the steps taken to capture different metrics and process the resulting dataset in Chapter 3. Results are analyzed and discussed in Chapter 4. Lastly, a conclusion is made in Chapter 5 with recommendations.

## 2 Literature Study

This chapter will look at NB-IoT performance-related literature, IoT, LPWANs, use cases, and a deeper look into NB-IoT itself.

### 2.1 Related Literature

Considering the current literature in NB-IoT, several studies investigate mathematical models and theoretical analysis in terms of energy consumption[4], latency [5], impact of ECL classes [6], coverage performance [7], battery lifetimes [8],[9], theoretically optimized configurations [10] and general performance in particular applications [11],[12].

Only Martinez [2] focuses efforts on the application developer and presents an empirical evaluation of the technology when it is deployed on a single network (Vodafone in the Metropolitan area of Barcelona). Durand [1] compares different LPWANs empirically including NB-IoT. Although theoretical models help to understand the inner workings of a technology with an attempt to predict the behavior, an empirical approach shows hands-on how a technology behaves in real conditions, and ultimately the variability in UE devices. Thus, this work complements Martinez and related works by investigating variability with respect to various LTE vendors and providing empirical measurements and estimates, always while taking the perspective of an adopter in the technology.

Whilst this research is funded by MTN and being aware of internal documentation, this is an independent study which should aid any potential adopters of the technology.

### 2.2 Internet of Things

The Internet of Things (IoT), as briefly outlined in §1.1.3, is an ecosystem of smart devices that connect to the internet/cloud in various ways. Although IoT's requirements (§2.2.1) are loosely defined due to the large variety of use cases (§2.4), it is still important to see how well NB-IoT performs and facilitates these connections for IoT (discussion in §5). This section looks at these requirements and other facets of IoT relevant to NB-IoT.

Since IoT is advancing in popularity (§2.2.1), stakeholders in NB-IoT can be rest assured that the technology will be useful for years to come.

Although the simplest type of use case is smart metering (§2.4.1), useful for LPWANs which send data unidirectionally, NB-IoT shows its bidirectional strength in Push-Pull models (§2.2.2). In fact, this makes NB-IoT well suited for edge computing (§2.2.2) too.

Finally, although satellite IoT has the benefit of worldwide coverage, by rolling out national NB-IoT coverage in South Africa, for example, it defeats the purpose of satellite IoT by being affordable and energy efficient (see §2.2.3).

#### 2.2.1 Requirements and Advancement

IoT requires scalable smart devices to collect data and interact with the physical world using wireless connectivity. Thus, wireless communication must be energy efficient, have low latency, low data overhead and long range for optimal cloud processing. To be sure that LPWANs can be well scaled, they require a cloud platform well suited to the large number of connections such as Cisco-Jasper and ThingsBoard [13].

---

IoT has surged in popularity over recent years as an interconnected system of devices that transfer data over a network without requiring human interaction.

Looking at Gartner's analysis of technology expectations with regards to NB-IoT and related technologies, in 2014 Gartner estimated that Internet of Things (IoT) had reached the height of inflated expectations, and the

hype it generated lives on in a rich ecosystem of emerging technologies. As of July 2018, NB-IoT and IoT has falling interest (and hype) in Fig. 2.1, yet it will reach productivity in 2-10 years time. Since new coverage has not been rolled out for almost two years to date, we believe there is a strong chance for renewed NB-IoT interest in Africa. Although predictions vary, Gartner estimates there will be over 21 billion smart devices connected to the internet by 2020, whereas the worldwide number of devices was under 7 billion in 2016 [14].

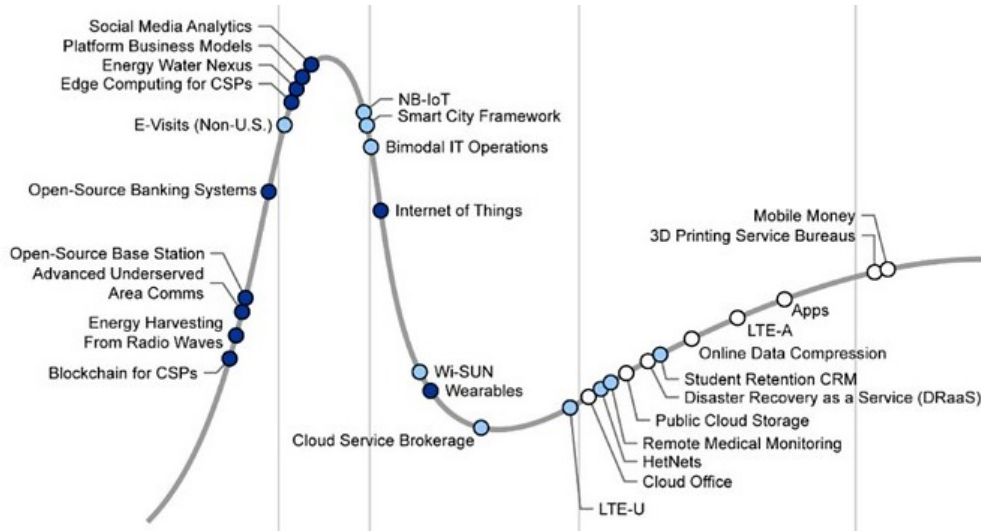


Figure 2.1: Gartner’s 2018 Hype Cycle for ICT in Africa. NB-IoT is high on the list of expectations.

As of August 2019, Gartner has high expectations for 5G and other emerging technologies which can make use of what IoT has to offer. This can be seen in Fig. 2.2.

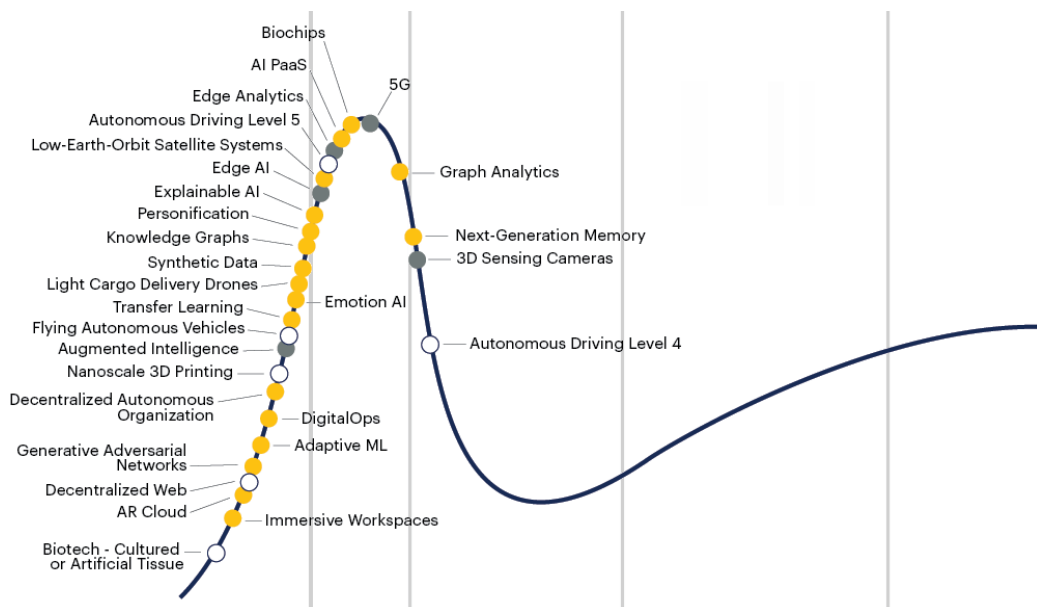


Figure 2.2: Gartner’s Hype Cycle for Emerging Technologies, 2019. IoT is inextricably linked to at least a third of emerging technologies and also has uses in NB-IoT.

On the other hand, this does not slow the growth in the number of devices connected as in Fig. 2.3. IoT merely manifests itself in other uses and forms such as we have already seen in Fig. 2.2. NB-IoT can be integral to aid this growth.



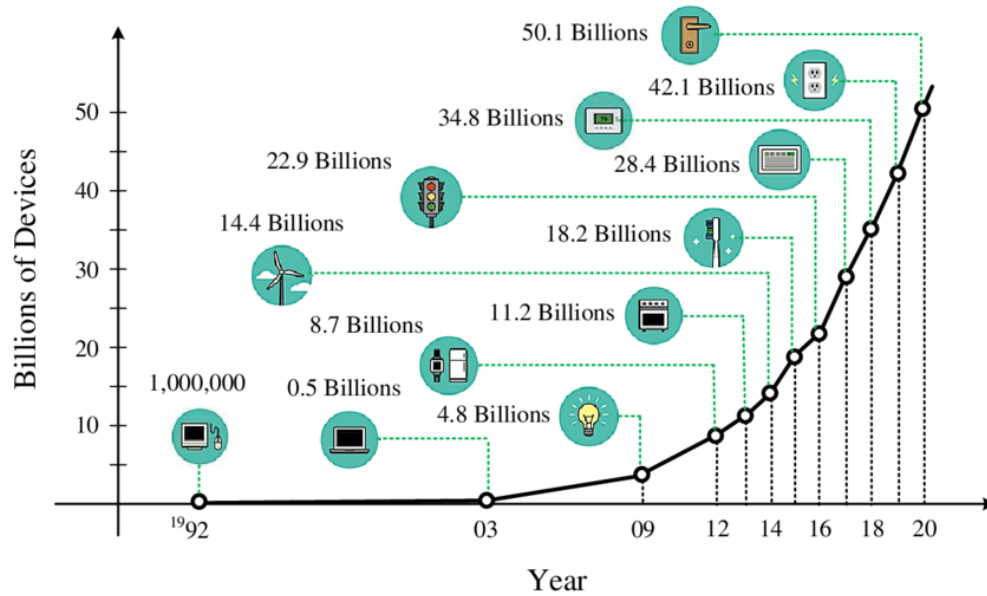


Figure 2.3: Exponential growth of IoT is estimated [15].

New and emerging applications in IoT are challenged by the number of existing technologies to choose from, and vice versa for existing applications when new wireless technologies appear. Massive IoT is the deployment of an immense number of low-powered devices with infrequent reporting and both NB-IoT and LTE Cat-M fulfill the requirements of 5G massive MTC/IoT.

### 2.2.2 Push-Pull Model and Edge/Fog Computing

Traditionally, IoT devices push data to the internet at regular intervals. This push model can be considered quite energy inefficient, especially when the data is only occasionally actionable. For example, in asset tracking or remote monitoring.

A pull model is ideal for dynamic rule engines, pulling data only when necessary and ultimately edge computing, where building an application around this idea can greatly enhance battery life.

Most LPWANs are unidirectional, meaning they transmit data in one direction only. This is especially true in the case of LoRaWAN and SigFox and means they use a push model. A push model is bad for the battery when periodically sending data. It does help to make the data transmission event-based, however. NB-IoT and Dash7 for example, are bidirectional which means they can stay quiet for longer and only send data on-demand ~ when it is needed. This would make it a pull model and is useful for critical use cases as well [16].

Table 5: Unidirectional and bidirectional LPWANs

Unidirectional	Bidirectional
SigFox	NB-IoT
LoRaWAN	EC-GSM-IoT
NB-Fi	RPMA
	Weightless SIG
	Dash7
	WiFi HaLow

Most importantly when looking at bidirectionality vs unidirectionality is that transmit current is usually much more than the receive current required. By limiting TX transmissions such that the user only requests

data on-demand when it is required, battery savings ensue. There are many LPWANs out there, but we can split them up into two groups as in Table 5. Later, we look at a few of these directional LPWANs in §2.3.1-2.3.2 and draw comparisons in §2.3.3.

### 2.2.2.1 Edge/Fog Computing

Edge/Fog computing is the practice of offloading cloud processes to the endpoint. It saves on data overhead, especially when there are data charges involved and battery longevity is desired.

Since NB-IoT is optimized for downlink communications, it can be the ideal candidate. Downlink communications use much less energy than uplink, and at higher throughput too. Usually data has to be periodically sent to the cloud in unidirectional networks and processing done thereafter, but with the push-pull model, one can send a specialized request to devices on the edge of the cloud and devices can send back processed data, saving energy and lowering data costs, hence edge/fog computing [17].

### 2.2.3 Satellite IoT

Compared to LPWANs, Satellite IoT has global coverage and is of growing interest for connecting ‘things’ to the internet due to its ease of connectivity [18]. In terms of packet payload size, a typical system such as the Iridium 9602/9603 will transmit up to 270 bytes or receive 340 bytes via AT commands. A supercapacitor is necessary for the initial 7.5W burst for 10ms which opens a session, and with an open sky messages can be sent every 10 seconds. It even features a ‘Ring Alert’ feature, similar to eDRX in NB-IoT in that modems listen for when incoming messages are available, for satellites to page a modem when a mobile terminated (MT) message is available from an internet-facing endpoint. Although Ring Alerts are sent to the position of the last known transmission, an Iridium satellite spot beam is about 400km in diameter meaning devices would have to travel quite far before requiring a simple re-registration transmission. The greatest drawback is the upfront, rental and per byte costs looking at £159, £12/month and £0.14 per 50 byte credit respectively on Rock Seven Mobile Services Ltd, and the high power draw compared to NB-IoT. Furthermore, NB-IoT is not the only network that can replace satellite IoT or 2G/GPRS with coverage in broad areas (ideally nationally), and this will be explored further in 2.3.

## 2.3 Low-Powered Wide-Area Networks

A low-power wide-area network (LPWAN) allows long range communications at low bit rates for sensors and other devices operating on battery power. This section will compare a few prominent cellular and unlicensed frequency LPWANs against NB-IoT besides the following alternatives:

- EC-GSM-IoT is a form of eGPRS optimized for the IoT. It is still in the trial stages of development, however [19].
- RPMA by Ingenu is a 2.4GHz technology for M2M communications. It is primarily used in North America for the oil & gas industry, amongst others [20]. It is equivalent to cellular standard but expensive.
- Weightless SIG reuses TV whitespace, and NB-IoT is actually formed off this protocol [21], [22].
- NB-Fi Protocol is an open standard, operating in unlicensed ISM frequencies. The NB-Fi Protocol ensures up to 10 km range of data transmission in urban areas, 30 km in rural areas and up to 10 years battery lifetime [23].
- HaLow is a long range and low power version of the IEEE 802.11 Wi-Fi standard, specified by Wi-Fi Alliance 802.11ah. Although it has great potential in IoT, at this stage it has low market traction.

### 2.3.1 Unidirectional LPWANs

#### 2.3.1.1 LoRaWAN

LoRa is a low-power wide-area network technology. It is based on spread spectrum modulation techniques derived from chirp spread spectrum technology.

LoRa is an LPWAN based on chirp spread spectrum modulation techniques developed in France by Cycleo, founded in 2009, and acquired by Semtech which founded the LoRa Alliance. Although it is a contender for NB-IoT, it lacks bidirectionality and data rate.

- Although LoRaWAN performs better for brief messages, it incurs high energy usage when multiple messages are required.
- Secondly, LoRaWAN messages are not guaranteed, and ensuring reliability on a higher level consumes even more energy in the use of user-defined acknowledgements.
- LoRaWAN is only scalable to under 500 devices per gateway compared to NB-IoT and GPRS which can handle 100 times more. This is due the lack of scheduling between devices, duty-cycle limits and few channels. A suggestion is to increase the number of base stations in an area.

LoRaWAN uses chirp-spread-spectrum (CSS) and is publicly accessible from networks such as The Things Network (TTN). Unfortunately, although that has the best coverage, it only uses class A which means it cannot listen for asynchronous downlink messages except after an uplink (which defeats the purpose of avoid unnecessary uplink transmissions which draw large current) [24].

#### 2.3.1.2 SigFox

Sigfox, headquartered in France and founded in 2009, is a global network operator that has over 375 employees. In South Africa, its subsidiary is known as SquidNet. Briefly, SigFox is an ultra-narrow-band wireless technology that one can send 140 12-byte messages per day due to the duty cycle limitation of unlicensed frequencies. One can also receive 4 downlink ack messages, but this is not good enough when looking to optimize the sending of GPS/GNSS updates [25]. SigFox is a contender for NB-IoT, but it lacks bidirectionality and data rate.

Simulations show that with the random transmissions of 55k devices, a base station can still receive and process 270 simultaneous messages while still ensuring a 99.9% PDR [1].

Localization can be useful for asset tracking as discussed in §2.4.3. Of the prominent LPWANs, SigFox is the only one that offers a simple localization service. NB-IoT will offer one when upgraded to 3GPP Release 14. Unfortunately SigFox has poor accuracy as can be seen in Fig. 2.4.



Figure 2.4: With a 17.783km radius in this example, SigFox is poor when it comes to being considered as a source of localization using RSSI triangulation, and it may be better to use TOF techniques such as in OTDOA in NB-IoT

### 2.3.2 Bidirectional LPWANs

#### 2.3.2.1 NB-IoT

Narrowband Internet of Things is an LPWAN radio technology standard developed by the 3GPP to enable a wide range of low-power devices and user applications in the cellular industry. The specification of LTE Cat-NB1 was frozen in June 2016 with 3GPP Release 13. Other IoT technologies developed by the 3GPP include LTE-M/eMTC and EC-GSM-IoT.

NB-IoT is LTE's replacement for the power hungry GSM that some IoT devices still use. GSM is an aging technology which is being turned off in some parts of the world. It has 7 times better range and coverage, and power saving which can let a device last 10+ years on a single charge [26].

#### 2.3.2.2 Dash7

DASH7 Alliance Protocol (D7AP) is a patented, bidirectional, full-stack and open source protocol which operates in unlicensed frequencies. It was developed from a military RFID standard into a medium range LPWAN [27],[28] useful in the indoor and outdoor realm. D7AP communication is modelled after "BLAST" (Burst, Light, Asynchronous, Stealth, and Transitional) systems which enables it to be a LPWAN competitor. D7AP uses the 2-GFSK modulation schemes, yet it can also reuse the PHY layer (radio frontend) of other LPWANs such as LoRa. Also, according to Cortus it should be possible to reuse the RF PHY layer (MSK downlink, OFDM uplink) of NB-IoT for Dash7's OSI stack, and in asset tracking, for example, it results in a compressed tracking solution that works well both indoors and outdoors. Dash7 claims 1m indoor accuracy by using vertex data from reference nodes for RSSI & RF fingerprinting.

Wizzilab is one of three main developers of Dash7. It offers the only full-kit open to development (at least in the form of an application processor). Haystack is another Dash7 developer with <https://github.com/jpnorair/OpenTag>, and have developed a Dash7-over-LoRa implementation that expects ranges of over a few kilometers and can be considered in future research. Finally, the developer community with <https://github.com/MOSAIC-LoPoW/dash7-ap-open-source-stack>.

### 2.3.3 LPWAN Comparison

There are many wireless technologies out there, with some standardized, including but not limited to SigFox, LoRaWAN, Dash7, Bluetooth, 6LowPan, RPMA, Weightless, and IETF 6TiSCH. A brief comparison is drawn on NB-IoT against prominent unlicensed frequency LPWANs in Table 6, and cellular LPWANs in Table 7.

Table 6: Brief comparison of NB-IoT against wireless LPWANs

	NB-IoT	LoRaWAN	SigFox	Dash7
Frequency	450-2200 MHz	433, 868, 915 MHz	868 MHz	433, 868, 915 MHz
Bandwidth	200 kHz	125-500 kHz	200 kHz	25, 200 kHz
Throughput	250 kbps	27 kbps	0.1 kbps	167 kbps
Duty cycle limitation	0%	90-99%	99%	LBT ~ 0-99%
Messages per day (12 B)	14 million	10-243	140	86400+
Bytes per message	512	255	12	256
Uplink Latency	0.1 - 10 s	< 3 s	~ 6 s	< 0.015 s
Battery Lifetime	10 years	10 years	16 years	3-5 years
MCL	164 dBm	157 dBm	160 dBm	-
Scalability	55,000	~500	> 50,000	-
Outage	1%	> 2%	1%	-
Average Power	550 uWh	15-66 uWh	144 uWh	-
Range	2.5 - 5 km	5km (85% PDR)	3-10 km	2 km

Table 7: Brief comparison of NB-IoT against cellular technologies [29]

	NB-IoT	2G/GSM/GPRS	EC-GSM-IoT <sup>1</sup>	LTE Cat-M
Frequencies	450-2200 MHz	850-1900 MHz	850 - 1900 MHz	450-2600 MHz
Bandwidth	180 kHz	200 kHz	200 kHz	1.4MHz
Throughput	250 kbps	56–114 kbps	70-240 kbps	375 kbps
Packet size	512	~ 1400	-	~ 1024
Uplink Latency	0.1 - 10 s	0.3 - 1 s	0.7 - 2 s	0.1 - 10 s
Battery Lifetime	10 years	3 months	10 years	10 years
MCL	164 dBm	148 dBm	154 - 164 dBm	164 dBm
Scalability	55,000	52,000	50,000	55,000
Range (urban)	2.5 - 5 km	1 - 2 km	-	2.5 - 5 km

To meet application specific requirements, the uniqueness of each technology gives each its advantages and disadvantages. Matching custom applications with a wireless technology is non-trivial as there is no silver bullet that matches all use-cases. In terms of a few metric capabilities, a best-and-worst case matrix is shown in Table 8. NB-IoT is shown to be closest to being an all-round winner, with battery life the exception. This is another reason why battery life is investigated in this study.

Table 8: LPWAN strengths with ✓, × denoting best and worst case respectively.

Technology	MCL	Scalability	Battery life	Throughput
NB-IoT	✓	✓		✓
GPRS	×	✓	×	✓
LoRaWAN SF7			✓	
LoRaWAN SF12	✓	×		×
SigFox	✓	✓		

The competitive nature of LPWANs, IoT demand, various use cases and expansion into other territories will ensure that various wireless technologies will continue to grow and increase network coverage. Selected uptake of LPWANs is expected in specific use cases due to the uniqueness of each technology. Despite this, NB-IoT outperforms SigFox and LoRaWAN in UL/DL throughput, scalability, MCL range and FoTA updates and is only superseded by LoRaWAN in battery life for SF7. Durand suggests that if the RRC-idle phase could be reduced, it could develop a minimal power consumption comparable to SigFox and LoRaWAN [1], and this is possibly true using Release Assistance in §??. By finding ways to increase battery life, it may just be the ‘silver bullet’ for all IoT use cases.

In places requiring deep indoor penetration with 30 dBm path loss, NB-IoT performs well with 8% outage, while SigFox, LoRaWAN, GPRS are unable to cover 13%, 20% and 60% of locations, respectively, in a 7800 km<sup>2</sup> area simulated by Lauridsen [30]. NB-IoT’s mean energy values are similar to LoRaWAN devices transmitting in SF12 configuration. However, best case results (in 5th percentile) are comparable to LoRaWAN in SF8. NB-IoT has peak transmission at 220 mA, whilst LoRaWAN at 40 mA [2]. Although LoRaWAN has the predictable chirp spread spectrum (CSS) modulated signal, NB-IoT only uses this peak power in its initial physical random access channel (PRACH) [1]. This shows that with further investigation into the variation, NB-IoT can certainly be on par with LoRaWAN in terms of energy consumption. Nevertheless, NB-IoT does guarantee packet delivery if within range while LoRaWAN has a variable packet delivery ratio (PDR). The mean achievable lifespan for NB-IoT is on the order of 2.5 years, depending on datagram size. Nevertheless, the transmission of larger datagram payloads (up to 512 bytes) had almost no impact on NB-IoT [2]. Finally, simple periodic-reporting applications can model the average power approximately by Eq. 1:

$$P = \frac{E_{msg}}{T_{msg}} \quad (1)$$

<sup>1</sup>eGPRS/EDGE-based EC-GSM-IoT is not available anywhere in the world yet.

If downlink latency is a critical component without battery life constraints, GPRS would be better suited as it requires constant signaling between BTS and UE device. Otherwise, applications requiring bidirectional communications of more than 120 bytes per day should use GPRS or NB-IoT, as LoRaWAN and SigFox are limited by duty-cycle since they use unlicensed frequencies. In deep coverage situations, SigFox and NB-IoT is recommended as it offers an MCL of more than 158 dBm [1]. In South Africa, GPRS and SigFox have similar levels of coverage, and the choice in wireless technology depends on data throughput. Low bandwidth wireless technologies typically have more range than their high data throughput counterparts. That's why SigFox requires few sites to cover vast areas, compared to GPRS or LTE networks. NB-IoT should be similar to SigFox in this regard, as they share similar MCLs.

In South Africa, IoT devices in deep coverage situations are recommended to use either SigFox or NB-IoT as they offer a maximum MCL more than 158 dB. For general use, GPRS provides wide area coverage due to its matured infrastructure. In terms of throughput, it's important to note that unlicensed spectrum LPWANs such as SigFox and LoRaWAN are heavily duty cycled, unlike cellular technologies such as NB-IoT or GPRS.

## 2.4 Use Cases

IoT has use case requirements in uplink and downlink transmission, throughput, battery longevity and scalability. Two types of use cases are looked at here for their unidirectional and bidirectional behaviors, namely smart metering and actuator control, and a novel way of using downlink control in asset tracking is presented before a list of use cases.

### 2.4.1 Smart Metering

One of the simplest and most popular use cases in IoT is smart metering. Periodically sending uplink data at regular intervals from a static location has the advantage of remote monitoring and reducing the need for physical readings. It also opened up new features for users (such as dynamic pricing and usage pattern analysis) and operators (such as load balancing a large number of clients). The clear value proposition and success is partially due to the belief that IoT should be low powered and low data transmissions which still exists today and has made it the traditional IoT model.

Smart metering can be easily applied to most LPWANs, but only a few have synchronous downlink capabilities, and NB-IoT can be considered well suited for bidirectional uses cases such as actuator control.

### 2.4.2 Actuator Control

An actuator is a machine component that controls a mechanism or element, such as a valve. In this use case, actuator control requires bidirectionality for its downlink controllability. Surprisingly, this bidirectionality can be applied to many fields as in Table 9.

Table 9: List of Use Cases

Public Safety & Security	Smart bicycles
Agriculture	Parking
Smart Metering	Garbage bins
Actuator Control	Intelligent buildings
Real-time Monitoring	Pet tracking, Smart Lost and Found
Asset Tracking	Point-of-sale terminals
ITS, Automotive & Logistics	predictive maintenance
Health Care	Mobile Advertising
Industrial Production	Environmental Control Systems
Energy, Utilities	Industrial Automation Systems
Retail	Wearables

### 2.4.3 Asset tracking

Many use cases in IoT benefit from the location whereabouts of a device, making positioning a vital aspect. 3GPP has dedicated a significant effort during its Release 14 to enhance location support for LPWAN technologies, such as NB-IoT and LTE-M. Although there are still design challenges that need to be taken into consideration, the 3GPP is working on enhancing location support such as the downlink-based OTDOA positioning method. OTDOA positioning reference signals can also be simulated to illustrate positioning performance [31],[32].

TDoA, ToF, Aoa, RSSI, are all land-based techniques for pinpointing the location of an endpoint. They require real-time clocks accurate to the millionth of a second as well as expensive gateway hardware. Depending on the frequencies, wireless network and modulation, one can get different ranges. This is useful for the indoors. Unfortunately, range is sacrificed for accuracy.

Satellites, on the other hand are in stable LEO or geostationary orbits and a constellation of satellites can keep in constant synchronization using atom clocks . One retains accuracy, even over long distances due to the ultra high precision of the clocks. This is useful for the outdoors.

Besides having the ability to measure RSSI which seems quite standard in wireless networks, NB-IoT is also lucky to have the benefits of re-using the Timing-Advance (TDoA) hardware when upgrading cellphone towers with the capability. This means that one can reasonably approximate the position of an endpoint to within a 1000m.

Consider a unidirectional wireless network that, although it has many kilometers of range, has limited capability in receiving downlink messages from gateways. Adding a GPS/GNSS module is increasingly trivial and inexpensive these days [33], although one still has to deal with the occasional cold start and periodic receive windows to determine the whereabouts of the device in question [34]. To avoid using the receive windows unless necessary, one can easily know when a device is static by observing movement via an accelerometer or similar [35], but purposefully locomotive devices require more computationally expensive means such as dead reckoning to determine if the endpoint has moved significantly to require another GPS/GNSS location update [36].

One of the benefits of bidirectional LPWANs over satellite localization is the fact that towers have the capability of beaconing a positioning reference signal [31]. A more effective alternative to determining location besides satellite localization can be periodically observing the receive signal strength indicator (RSSI) for changes which directly translate to movement in meters which warrant a GPS/GNSS location update. RSSI has been used in fingerprinting localization for GSM-based devices [37]. Listening for a terrestrial tower certainly doesn't require a lower receive sensitivity than for a satellite a few hundred kilometers in the sky, and with a much higher throughput than the typical 50 bit/s of GPS/GNSS. GPS/GNSS signals can also be relayed indoors using an outdoor and indoor antenna [38].

Durand [1] suggests NB-IoT is poor for asset tracking and utility metering due to its high energy transmissions. By using the push-pull model as in 2.2.2 and only pulling data when a device's data/location is desired or pushing data when out of a geofence, one can save energy so much so that it can be considered better than LoRaWAN or SigFox, even though they may use less energy per transmission.

## 2.5 A Deeper Look into NB-IoT

This section describes NB-IoT in more detail and the setup procedures involved.

### 2.5.1 Development and Present Standing

Formed by the 3GPP from LTE, NB-IoT was developed within that framework and its capabilities are particularly well suited to smart metering.

Compared to LTE, NB-IoT devices are usually stationary with intermittent burst transmissions, low data bandwidth, delay-tolerant applications, support for a huge number of devices, dealing with poor coverage (indoor penetration) and having a battery lifetime of at least a few years.

Taking it one step further, the 3GPP defined two device categories, namely Cat NB1 and NB2, with the latter adding support for:

- Device positioning/location using OTDOA
- Seamless intra-and-inter-cellular cell-reselection for improved mobility.
- Push-to-talk voice messaging
- Multicast transmission to multiple devices simultaneously.

NB-IoT devices are seen as static, delay tolerant with periodic reporting of small chunks of data. The technology is designed such that it can be used in areas which extend beyond the reach of standard cellular networks and last up to 10 years on a battery. Devices will generally send small amounts of data infrequently; with a typical usage scenario sending 100 to 200 bytes twice per day for battery powered devices. For mains powered devices the limit is not based on battery size, but cost and network bandwidth/resources.

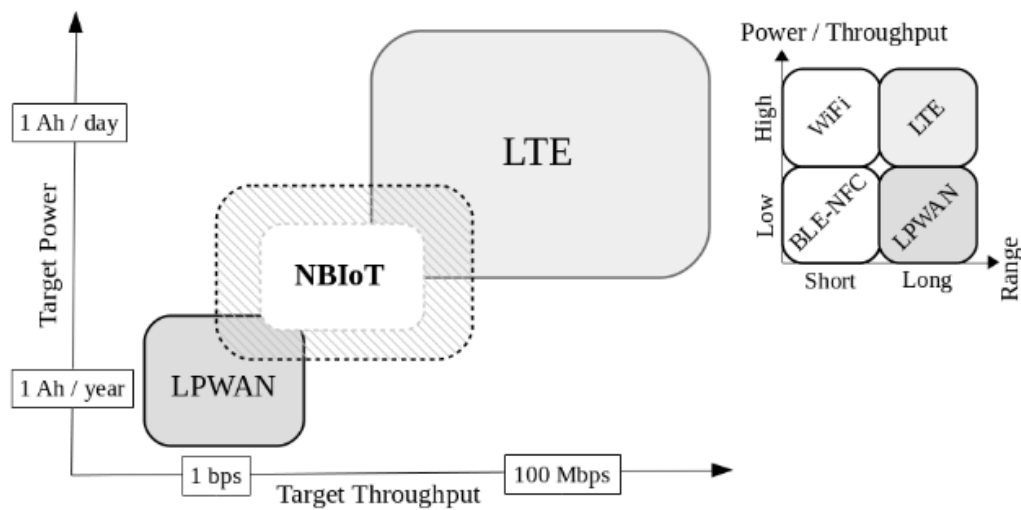


Figure 2.5: IoT Wireless Technology Representation [2]

The system operation is analogous to SMS in that it is a datagram-oriented, stored-and-forward system, rather than a GPRS-like IP pipe. This is because NB-IoT devices spend most of their time asleep, making possible the required long battery life. The system implements extended DRX cycles for paging, but as this window will be limited to save battery life, the delivery of downlink messages occurs mainly when the system detects that uplink messages have been received from a device (indicating that it is awake). Here a store-and-forward system, an “IoT Platform”, is useful.

NB-IoT has a certain standing in IoT and LPWANs, and this can be seen in Fig. 2.5. It would be on a par with LPWANs except for variable energy consumption.

Low Power Wide Area Networks (LPWANs) include SigFox, LoRaWAN, NB-IoT, Dash7, Weightless, N-Wave, NB-Fi, Thread and others. Some of these, like SigFox and LoRaWAN are unidirectional, which make them unsuitable for critical applications which require downlink acknowledgement or more. These have ranges from 2 - 20 km and can be considered outdoor technologies along with cellular IoT [23].

Low Power Local Area Networks (LPLANs) include BLE, 6LoPAN, Thread, ZigBee, WiFi and others. Unfortunately, due to country regulations the output power is limited especially for unlicensed frequencies. They may not even be suited for long range on the PHY layer, but they can essentially be considered indoor technologies with ranges of 10-100m [39].

Cellular-IoT includes LTE Cat-M, LTE Cat-NB or NB-IoT and EC-GSM-IoT. GSM has high battery usage due to constant synchronization in active mode, and un-optimized transmission of data. It is generally not considered in this thesis because it is a sunseting technology. LTE-M is also considered a high-power



technology and is not as suited for IoT as NB-IoT is [40], although there is evidence that it is quite similar [41]. Maximum coupling loss (MCL), discussed more in §2.5.7.1, is defined in different scenarios (3GPP 36.888, RP-150492 and 45.820 7A) giving NB-IoT a significant 8 dBm edge over LTE Cat-M, at 164 dBm. By using the same assumptions, LTE Cat-M actually performs slightly better. In terms of power, LTE Cat-M uses 50% less power, except for deep penetration cases where NB-IoT's uplink fares better (LTE Cat-M will match this in Release 14). Finally, in terms of cost, NB-IoT is only marginally cheaper than LTE Cat-M by < 2% [41].

Martinez [2] has explored NB-IoT from the perspective of the application developer. When evaluating performance, it would do well to find the limits of the technology as well as find the optimum 'sweet spot' or range for efficient operation. This decent study on the operational trade-offs of NB-IoT over LTE proves NB-IoT to be competitive in terms of energy consumption amongst other LPWANs. Although there are many complexities such as signalling, dynamic adjustments triggered by network conditions and timings, its competitive energy consumption is due to 3GPP efforts to match LPWANs. By using proprietary spectrum over unlicensed ISM bands, NB-IoT avoids external interference and mandatory duty cycling. Even though employing increased repeatability due to the ECL mechanism increases unpredictability in device behavior, it ensures reliability by guaranteeing delivery unless outside the maximum range or signal strength bounds that a device can communicate with a tower. This variability in delivery time can be a deal-breaker for some critical applications, but on the whole it is suitable for delay-tolerant applications, and under 10 seconds will cater for most use cases. The ownership model is a connectivity service or contract, and is charged per byte. Coverage depends on deployed infrastructure.

A user would consider critical characteristics such as energy consumption, coverage, cost, network latency and behavior. Martinez looks at these except for cost, which is better looked at by Ali [15]. A set of tests were devised and results showed that in some cases its energy consumption performed better than an LPWAN referenced technology such as LoRa, with the added benefit of guaranteeing delivery. However, the high variability in energy consumption and network latency call into question its reliability especially for mission-critical applications.

In future NB-IoT will have the capability of D2D communications as outlined in 3GPP future release specifications.

### 2.5.2 LTE Architecture

Although most users interact only with the UE device which runs its own proprietary firmware stack, NB-IoT also has a complex backend architecture.

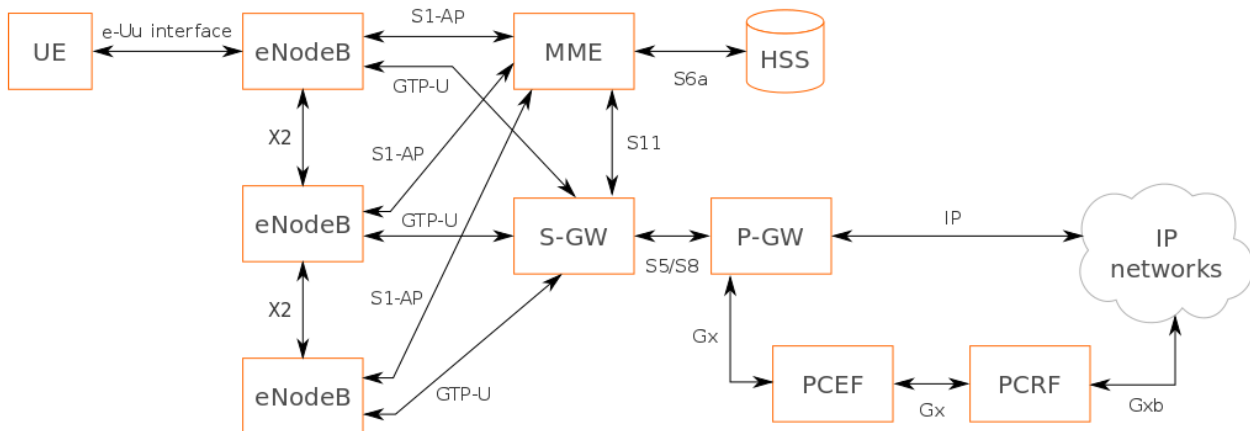


Figure 2.6: LTE classic architecture

The complexities of LTE architecture further increases the chance of performance degradation with respect to 3GPP specifications due to the vast array of setup parameters. It would be beneficial to analyze the performance of multiple UE devices against various MNO vendors. It is important to note that MNOs may

use various vendors in their architecture, and thus this study is mainly focused on the eNodeB vendor which is also UE device facing and has the greatest chance of performance degradation due network quality, RF interference and so forth.

### 2.5.2.1 System Information Blocks (SIBs)

System Information Blocks define configurations for UE device to follow, such as the method of attachment and number of transmission repetitions. Once an RRC connection is made, the eNodeB uses the perceived SNR to allocate uplink throughput the UE device can use to transmit messages. Because of dynamic allocation, predicting power consumption of a single message in the field is difficult. Example SIBs can be found in Appendix E. The most important one is known as the Master Information Block (MIB).

Since UE devices must follow NW settings broadcast inside the SIB, the UE device is to a large extent controlled by the network/eNodeB.

### 2.5.3 UE Device Hardware

This subsection looks at hardware specific to the UE device.

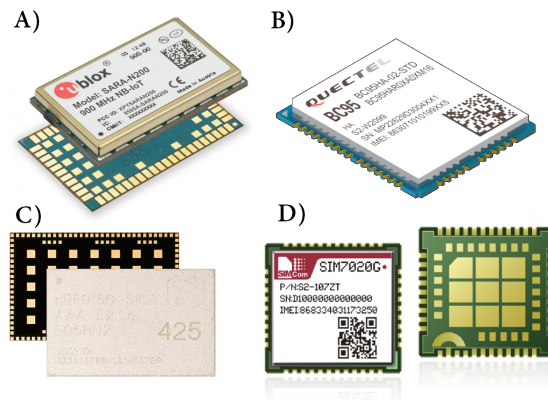


Figure 2.7: Examples of different NB-IoT UE modems with A) Ublox Sara N200, B) Quectel BC95, C) Nordic nRF9160, D) SimCom 7020E

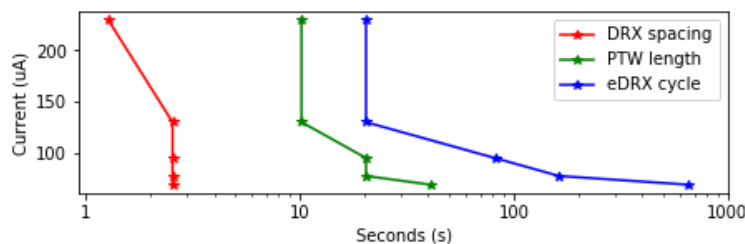


Figure 2.8: This diagram shows how current usage decreases depending on eDRX power saving configuration. (Based on SimCom 7020E modem datasheet values.)

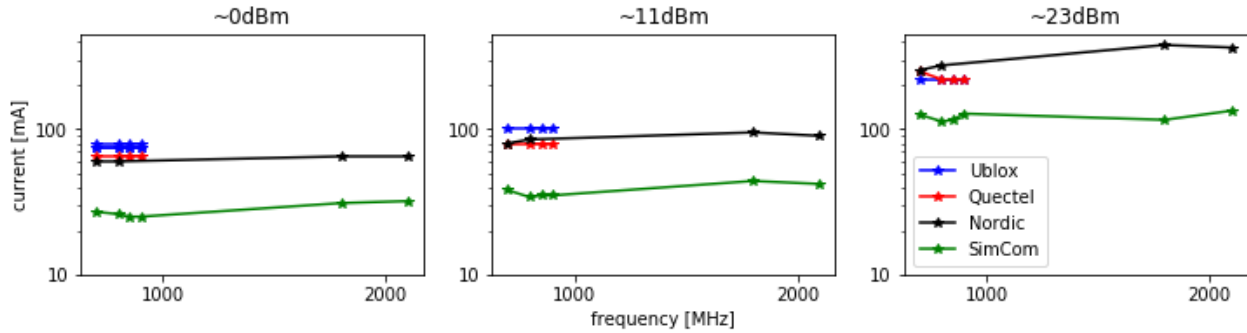


Figure 2.9: This diagram shows how current usage across different LTE bands changes depending on output power.

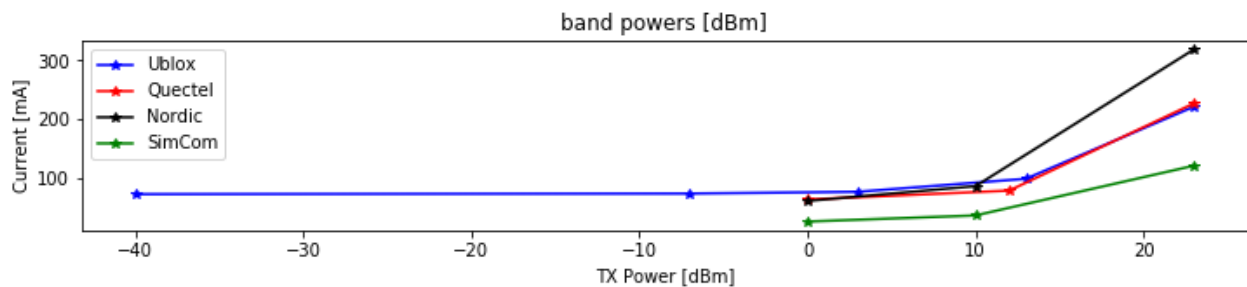


Figure 2.10: This diagram shows how current versus transmit power for NB-IoT modems remains stable under 0 dBm and increases exponentially until 23 dBm.

As seen in Figure 2.9, 2.10, Ublox and Quectel share similar traits, unlike Nordic and SimCom. Since Ublox and Quectel share similar traits, it is suitable for a comparison of LTE vendors.

#### 2.5.4 Network Registration, RRC Connection and Inactivity Timer

By default, NB-IoT modules usually try to register with the network defined by the current SIM card in the UE device at the time, and use the default APN from the network. During the registration process, an RRC connection is made to the base station. If the IMEI and IMSI of the module is not allowed on the network, the module will disconnect. This can be seen after the “1” then “0” response of the +CSCON AT command URC (provides signalling connection status) without +CEREG (network registration status) showing a “1” (registered) or “5” (registered and roaming), which means the module was not able to register on the network. It will also contain an EMM reject cause value, with more information in 3GPP TS 24.301. See [42] for a connection status compatibility matrix.

At the first registration or when the module wakes from the power save mode (PSM), it performs a Random Access CHannel (RACH) procedure to attach to the base station. This establishes a Radio Resource Control (RRC) connection to the base station. Once established only the base station can release this connection. The module cannot drop the RRC connection other than turning off the radio using the AT+CFUN=0 command.

After network registration or transmission of a data packet, the device usually enters RRC connected (C-DRX) for a network-specified `inactivity timeout` and receives all the base station (BTS) signalling. Sending and receiving messages in this mode is immediate, otherwise with no activity average power is typically ~50mA. If the RRC connection is left for 20 s of inactivity before the RRC is released, then this will consume about 1 mWh @ 3.6V. At the end of this period, if no messages are being transmitted from the module, the +CSCON response will be “0” to show the RRC connection has been released by the eNodeB.

### 2.5.5 Power-Saving Mechanisms

NB-IoT allows for various power saving mechanisms design to prolong the lifetime of battery-powered devices. Except for release assistance, the module automatically enters the different states depending on defined configuration. Release assistance, as explained in §??, terminates the network defined `inactivity timer` such that it enters into the states shown in Fig. 2.11.

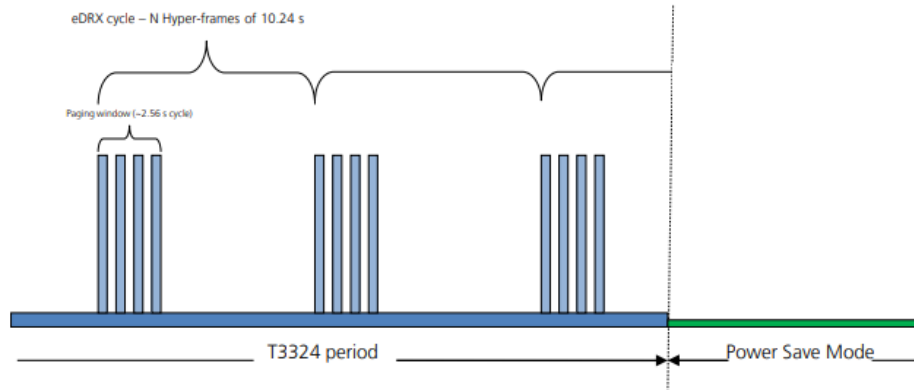


Figure 2.11: This diagram shows power saving mechanisms for NB-IoT, including paging windows, eDRX cycles, active timer and PSM mode.

It is recommended to order the network configuration values of the following from smallest to largest for proper operation:

1. Paging Time Window (PTW)
2. eDRX cycle value
3. T3324 Active Timer
4. T3412 PTAU Timer

#### 2.5.5.1 T3412 PTAU Timer

During the RRC-connected phase (C-DRX), the eNodeB knows exactly in which cell/sector/antenna the UE device is on a relatively precise level. Outside of this it assigns a tracking area code (TAC) and broadcasts to all UEs in the area with the aim to wake it up if there is an incoming message. This is especially useful if the device is semi-mobile and moves to a different area. The periodic tracking area update timer (PTAU) updates the network and UE devices with the tracking area that the residing device is currently connected at the end of the power saving mode (PSM) as in fig. 2.11.

Timers can be configured using AT commands.

Table 10: Configuring the T3412 PTAU Timer. Bits 5 to 1 represent the binary coded timer value. Bits 6 to 8 define the timer value unit for the PTAU timer as follows. See more in 3GPP TS 24.008 [4], figure 10.5.147a and table 10.5.163a.

8 7 6	Description
0 0 0	value is incremented in multiples of 10 minutes
0 0 1	value is incremented in multiples of 1 hour
0 1 0	value is incremented in multiples of 10 hours
0 1 1	value is incremented in multiples of 2 seconds
1 0 0	value is incremented in multiples of 30 seconds
1 0 1	value is incremented in multiples of 1 minute
1 1 0	value is incremented in multiples of 320 hours <sup>2</sup>
1 1 1	value indicates that the timer is deactivated <sup>3</sup>

- Example: “000 00111” = 7 x 10 minutes = 70 minutes

### 2.5.5.2 T3324 Active Timer

The T3324 Active Timer controls the time period during which the UE device can be paged by the network in RRC Idle, and the number of eDRX cycles. The inactivity and active timer is reset after a downlink message is received. Fragmented downlink data has a negative impact on energy savings which should be taken into account.

Table 11: Configuring the T3324 Active Timer. Bits 5 to 1 represent the binary coded timer value. Bits 6 to 8 define the timer value unit for the Active timer as follows. See more in 3GPP TS 24.008 [4], figure 10.5.147a and table 10.5.163a.

8 7 6	Description
0 0 0	value is incremented in multiples of 2 seconds
0 0 1	value is incremented in multiples of 1 minute
0 1 0	value is incremented in multiples of deci-hours
1 1 1	value indicates that the timer is deactivated

- Example: “001 00101” = 5 x 1 minute = 5 minutes

### 2.5.5.3 eDRX Cycles and PTW

Extended Discontinuous Reception (eDRX) mode means that paging windows can be scheduled such that the modem can be contacted by the server. A single eDRX cycle is composed of an active and sleep phase. The active phase is controlled by a Paging Time Window (PTW) timer, followed by a sleep phase until the end of the eDRX cycle, ranging from 10.24 seconds to 2621.44 seconds (43.69 minutes). Standard LTE paging is observed within Paging Time Windows (PTW), ranging from 2.56 s to 40.96 s, and control the number of DRX intervals within the window. DRX intervals are network controlled, and are usually set to every 1.28, 2.56, 5.12 or 10.24 seconds.

### 2.5.5.4 Release Assistance

Release assistance requests the eNodeB to release the RRC connection immediately. By avoiding 20 seconds of idle RRC in C-DRX mode, there is a 93% improvement in power consumption for a 200 byte transmission in ECL 1 [42]. This can also be done for data transmissions by sending a flag with the data packet. This flag is noticed by the MME on the network and the eNodeB releases the connection immediately thereafter. It remains within T3324 Active Time for a period of time where the eNodeB could be paging the device in eDRX intervals before going into deep sleep mode until the T3412 PTAU Timer expires. Unfortunately there is no support for release assistance for downlink data.

## 2.5.6 Repetitions and Enhanced Coverage Levels

Enhanced Coverage Levels determine the number of repetitions in the uplink channel. Coverage levels range from 0 for normal operation and 2 for the worst case scenario, and repetitions range from 2 to 128 in uplink, and up to 2048 in downlink. Although the network determines the ECL for the UE device, it is factors such as RF network conditions interference that influence the number of repetitions. Network operators should provide enough coverage to allow devices to be mostly in coverage class 0 or 1. Depending on the NB-IoT deployment, the network could have large areas, or devices located in deep locations which unfortunately mean they operate in Coverage Class 2. It would be best to minimize ECL 2 except for deep indoor penetration use

<sup>2</sup>This timer value unit is only applicable to the T3312 and T3412 extended value (see 3GPP TS 24.301 [5]). If received in an integrity protected message, the value shall be interpreted as multiples of 320 hours, otherwise 1 hour.

<sup>3</sup>This timer value unit is not applicable to the T3412 extended value. If received, the T3412 extended value shall be considered as not included in the message (see 3GPP TS 24.301 [5]).

cases due to the high energy usage since it uses high repetitions for the RACH process and also higher coding schemes when transmitting data.

An example of sending a 200 byte message in ECL 2 with good SNR can include 5 RACH transmission bursts, a Transmission Block Size ~43 bytes, one repetition and taking just over 1 second, consuming 200uWh. For the same example in bad SNR, the TBS allocated 32 bytes per chunk, with a repetition of 8 and 4. It took 5.5 seconds and consumed 1.07mWh – fives times as much as before.

### 2.5.7 RF Characteristics, MCL and monitoring network behavior

Path loss can be high if many LTE cells exist in an area. This causes interference, and devices cannot register on the best cell if it does not support NB-IoT [43]. In the uplink, there are two physical layer channels. The random access channel connects to the base station and the uplink channel contains the data and control information. In downlink there are four channels. Synchronization is used by the endpoint to estimate symbol timing and carrier frequency and obtain the cell identity and frame boundary. The broadcast channel contains the master information block (MIB). The control channel carries downlink control information and can be repeated 2048 times, as well as the data channel which contains the payload, paging, system information and the random access response. [7].

Nb-IoT requires at minimum bandwidth of 180 kHz to operate, which is equal to the size of the smallest Physical Resource Block (PRB) in 3GPP. It has three modes of operation, “in-band”, “guard-band” or “standalone”, with operation within, between or separate from LTE carrier signals, respectively. To support this, NB-IoT uses legacy LTE design such as the OFDM modulation (Orthogonal Frequency Division Multiplexing) in downlink, SC-FDMA (Single Carrier Frequency Division Multiple Access) in uplink, dynamic throughput, interleaving and channel codes. Major design changes from LTE include synchronization, broadcast, the random access preamble and the control channel. Although these design changes take into account the limited bandwidth offered unlike legacy LTE, they achieve the IoT requirements with decent co-existence entire system [7].

#### 2.5.7.1 MCL

Maximum coupling loss (MCL) is defined as the maximal total channel loss between UE devices and eNodeB cell antenna ports at which operation is still possible. In practice, it includes antenna gains, shadowing, path loss, noise and any other sources of signal deterioration. Robust links are associated with high MCLs.

$$MCL (dB) = P_{TX} - (Noise\ figure + SINR + Thermal\ Noise\ floor) \quad (2)$$

$$Thermal\ Noise\ floor = -174 + 10\log_{10}(Bandwidth) \quad (3)$$

#### 2.5.7.2 UE Device and Network Behavior

Users can monitor the status of the module’s connection, registration and PSM state by polling or configuring URCs. By monitoring the module status, it can behave more efficiently for various applications. The +CEREG AT command can be used to check the network registration status, including registered, not registered, in the process of registering, denied registration, unknown and roaming. During this process, when the module is searching for a network, the +NUESTATS AT command can be polled to view receive and transmit time-on-air. Increasing receive time means the module scanning for a base station, and increase transmit time indicates an attempt to register with a base station. If the Total Power (RSSI) and Signal Power (RSRP) values are different than -32767 (invalid) then the module has read the MIB and SIB signals from the base station. With the +CSCON URC enabled to indicate each RRC connection change, it will show a “1” when connected and “0” when not.

International SIMs (roaming SIM) can make the registration process takes many minutes for the first time. Once registered, the network PLMN should be stored in the SIM for faster registration next time.

The `+NUESTATS` AT command provides many other details, such as RF radio, network, throughput and data size characteristics.

Registration EMM reject cause values, as mentioned in §2.5.4, are described in the 3GPP TS 24.008 [4] with typical causes including:

- #5 IMEI not accepted
- #11 PLMN not allowed
- #12 Location Area not allowed
- #13 Roaming not allowed in this location area
- #22 Congestion

### 2.5.8 AT Commands

This section outlines how applications use the AT command API to access the capabilities of the UE device.

Table 12: Useful AT commands for Ublox, Quectel

Command	Description
<code>AT+NCONFIG</code>	<i>Set configuration.</i> Customize configuration for <code>SI_AVOID</code> , Scrambling etc.
<code>AT+CFUN</code>	<i>Enable modem functionality,</i> turns on radio or flight mode.
<code>AT+COPS</code>	<i>Network Registration.</i> This command initiates search for cell towers to connect to depending on MNO-related SIM-card and registers/deregisters accordingly.
<code>AT+CEREG</code>	<i>Network status.</i> Provides the status of network registration.
<code>AT+CGDCONT</code>	<i>Sets the APN</i> for the relevant MNO.
<code>AT+NUESTATS</code>	<i>Read status.</i> The UE device provides various parameters to read such as RF characteristics, network information and data metrics
<code>AT+UTEST</code>	<i>Test in non-signalling mode</i> transmit and receive.
<code>AT+CPSMS</code>	<i>Configure PSM modes</i> T3324 Active and T3412 PTAU timer
<code>AT+NPTWEDRXS</code>	Configure eDRX cycle value and paging time window (PTW)
<code>AT+NPING</code>	<i>Ping remote host</i> such as google's DNS server 8.8.8.8
<code>AT+NSOSF</code>	<i>Send UDP packet</i> up to 512 bytes with release assistance flags

Unsolicited result codes (URCs) are asynchronous messages output by the UE device to inform at any time of specific events or status changes such as the following in Table 13.

Table 13: Useful URCs for Ublox, Quectel

URCs	Description
<code>AT+CMEE=2</code>	Error result code
<code>AT+NPSMR=1</code>	Power saving mode changes
<code>AT+CSCON=1</code>	RRC connected changes
<code>AT+CEREG=5</code>	Network registration changes

In the setup stage, it is important to use `AT+NCONFIG="CR_0859_SI_AVOID", "TRUE"` and `AT+NCONFIG="CR_0354_0338_SCRAMBLING", "TRUE"` in South Africa as this is not documented in the application manual [42].

When it comes to base stations, the user does not have control over the inactivity timer. Release assistance can request the eNB/network to disconnect the modem from Radio Resource Control (RRC) connected mode.

When the module is synchronized to the base station, the `+NUESTATS` AT command is able to describe the radio, cell, BLER, throughput statistics and other signaling info received. The most useful statistic is the "RADIO" type.

Manufacturers usually provide application examples useful to test each command in development [42].

### 2.5.8.1 Application Architecture

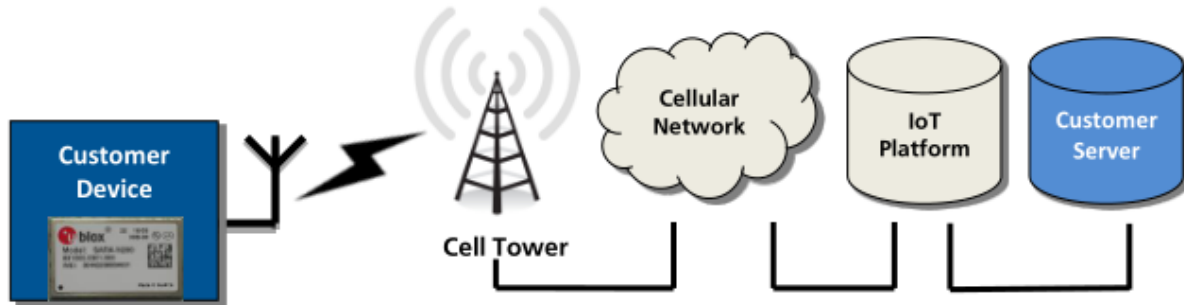


Figure 2.12: Typical application example ©Ublox

Users of NB-IoT modules include customers in industry, government enterprise and consumers and in essence they have the simple goal of reaching the internet. In Fig. 2.12, a typical customer's device communicates with a cell tower that supports NB-IoT. From there it propagates through the LTE infrastructure of the cellular network before it reaches the internet, usually in the form of an IoT platform and the customer's server. NB-IoT modules offer a few IoT layers to communicate, from simple UDP, TCP sockets to MQTT and CoAP messaging. Developers with a GPRS type background may expect a session-oriented always-on connection, however, NB-IoT has higher latencies which need to be considered, especially when setting up eDRX and PSM modes for the extended battery life lasting up to many years.

UDP sockets are connectionless, and packets may be lost. If the application doesn't provide its own acknowledgements, CoAP does take this into account when used over UDP.

For devices that stay dormant for long periods of time, the server will know when they are active when devices send an outbound message. It will be in RRC-connected mode until the inactivity timer expires, and it can still be paged within the T3324 Active period, so servers should respond timeously.

Martinez et al. [2] did empirical tests within the Vodafone Network in Barcelona. They observed UE device and NW behavior, measured current traces, and did various tests in different modes. Martinez suggested the following modes in Table 14.

Table 14: Suggested application power saving modes [2]. It should be noted that the network default for the Inactivity timer remains when registering and on downlink messages.

Mode	NW Configuration
<b>Mode 1</b>	Inactivity timer = 20s (network default) T3324 Active timer = 0s (disabled) C-DRX = 2.048s (network default)
<b>Mode 2</b>	Inactivity timer = Immediate Release T3324 Active timer = 8s I-DRX = 2.56s eDRX/PTW = Disabled
<b>Mode 3</b>	Inactivity timer = Immediate Release T3324 Active timer = 0s (disabled)

With AT commands, UE devices can be controlled to an extent on the client-side except for LTE network-side settings, transmit power and message latency. This loss of control comes at the cost of energy consumption, yet guarantee of message acknowledgement. Luckily, server-side applications can be aware of devices too and



send updated configurations and firmware-over-the-air (FoTA) updates for adaptability to devices due to their bidirectionality.

## 2.6 Summary

With a deeper understanding of NB-IoT in this chapter, we can see how it exhibits variable characteristics as opposed to what theoretical analysis or simulations can provide due to the complexities of the underlying legacy LTE architecture and most notably in the energy consumption of datagram packets, besides other metrics. NB-IoT has a strong footprint in IoT due to its low-power bidirectionality which gives it an edge over other LPWANs, and this enables a broad variety of use cases. Since we can now better understand the different facets of NB-IoT, related concepts and literature as stated above, we can further investigate the change in variability across different UE devices and LTE vendors in [Chapter 3](#).

## 3 Design and Methodology

As stated in §1.2.2, the aim of this study is to compare user equipment (UE) against mobile network operators (MNOs) with a set of tests that evaluate NB-IoT's performance according to a set of metrics which highlight striking differences due to the underlying complexities of LTE architecture.

Four mobile network operators (MNOs) are compared in South Africa according to the underlying vendor infrastructure used, namely Nokia and ZTE in the Cape/coastal regions and Ericsson and Huawei based in Gauteng/inland regions.

More than one UE is used to improve the accuracy of the result, namely Ublox and Quectel. A unit testing framework has been carefully prepared in Python in combination with a Hewlett Packard rotary RF attenuator in 10dBm steps. The results can be applied to multiple application use cases.

### 3.1 Preliminary Tests

These tests better orient the reader to the behavior of UE devices and LTE network.

#### 3.1.1 Network Info and Behavior

This section looks at certain informative aspects and behavior of LTE networks.

##### 3.1.1.1 System Information Blocks (SIB)

SIBs carry relevant information for the UE, which helps UE to access a cell, perform cell re-selection, information related to INTRA-frequency, INTER-frequency and INTER-RAT cell selections. In LTE there are 13 types of SIBs as can be seen in Table 15.

See Appendix E for examples of NB-IoT SIB blocks.

- Downlink `systemInformationBlockType1`
- Downlink `systemInformation`
- Uplink `rrcConnectionRequest`
- Downlink `rrcConnectionSetup`

Table 15: System Information Blocks description [44]

SIB	Description
MIB	Master Information Block which sends essential information required to receive further SIBs
SIB-1	Cell access related parameters and scheduling of other SIBs
SIB-2	Common and shared channel configuration, RACH related configuration are present
SIB-3	Parameters required for intra-frequency, inter-frequency and I-RAT cell reselections
SIB-4	Information regarding INTRA-frequency neighboring cells (E-UTRA)
SIB-5	Information regarding INTER-frequency neighboring cells (E-UTRA)
SIB-6	Information for re-selection to INTER-RAT (UTRAN cells)
SIB-7	Information for re-selection to INTER-RAT (GERAN cells)
SIB-8	Information for re-selection to INTER-RAT (CDMA2000)
SIB-9	Information related to Home eNodeB (FEMTOCELL)
SIB-10	ETWS (Earthquake and Tsunami Warning System) information (Primary notification)
SIB-11	ETWS (Earthquake and Tsunami Warning System) information (Secondary notification)
SIB-12	Commercial Mobile Alert Service (CMAS) information.
SIB-13	Contains the information required to acquire the MBMS control information associated with one or more MBSFN areas.

It is important to realize how intricate the underlying architecture of LTE is. For example, considering the

signalling between the UE and eNodeB using SIBs, we see this in action. This complexity hints that the probably cause of variation is due to the LTE network configuration.

### 3.1.1.2 Extended Coverage Level (ECL)

Extended Coverage Levels increase the amount of repetitions between UE and eNodeB to increase range. Henceforth, this should mean that a weaker signal strength increases the ECL level. There are 3 levels, with level 0 being the least repetitions, and 2 being the most.

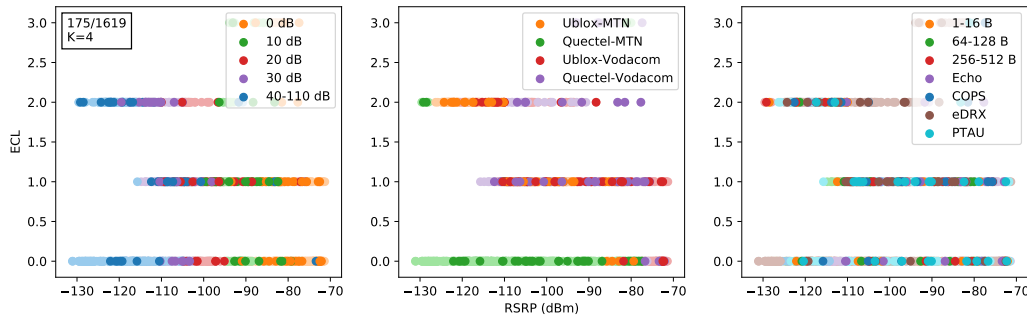


Figure 3.1: ECL levels shown against RSRP for Ublox and Quectel on ZTE-MTN and Nokia-Vodacom networks.

In this Fig. 3.1, ECL is shown as an example against two networks and it seems apparent that it is not determined by attenuation. Further investigation is necessary.

### 3.1.1.3 Cell ID, EARFCN, PCI

These identifiers are related to the specific cell towers the UE is connected to.

The Cell ID is the physical network cell ID. EARFCN uniquely identifies the LTE band and carrier frequency. PCIs, or Physical Cell Identifiers provide a psuedo-unique value for identifying eNodeBs and is a unique identifier for serving cells. The PCI value is created from two components - PSS and SSS. The PSS, Primary Synchronization Signal, has the value 0, 1, or 2. The SSS, Secondary Synchronization Signal, can have a value between 0 and 167.

Table 16: PCI, Cell ID and EARFCN count as a result of registrations with LTE networks. Tuples are in (Ublox, Quectel) format.

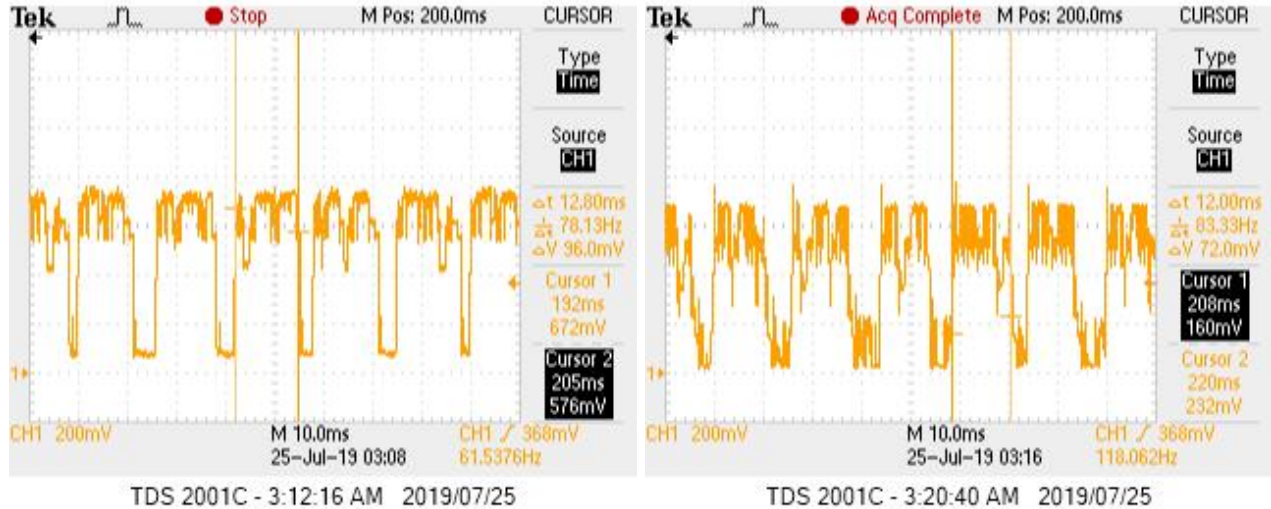
PCI	Cell ID	ZTE-MTN	Nokia-Vodacom
123	239882509	(34, 26)	
14	2671716	(13, 29)	
11	2672484	(1, 4)	
2	484196		(34, 32)
	EARFCN		
	3712	(48, 59)	
	3564		(34, 32)

In Table 16 we see three cell towers on the MTN-ZTE network. More than one tower at the same frequency or EARFCN proves that Intra-Frequency Cellular Reselection works as expected.

### 3.1.1.4 C-DRX mode

On the Vodafone network in connected-DRX (C-DRX) mode, the UE is observed to show peaks spaced at

regular 2.048s intervals [2]. On both Vodacom and MTN networks, these peaks are not visible and instead a steady stream of peaks can be seen as on the following images.



(a) C-DRX timing on MTN-ZTE-Ublox

(b) C-DRX timing on MTN-ZTE-Quectel

Figure 3.2: Timing measurement of two UEs on MTN-ZTE during C-DRX. Although the duty cycles vary in C-DRX mode, it can be estimated that pulses are roughly 12ms in length with 4ms idle between. This means that 75% of the time the UE device is drawing current.

In Fig. 3.2a, the Ublox UE uses 73.6mA at 110dB attenuation with the RF shield enclosure door slightly open and in Fig. 3.2b, with the same environment the Quectel UE uses 73.6mA. Observing C-DRX on the Nokia-Vodacom network, we have slightly different results as can be seen summarized in Table 17. It seems that on ZTE-MTN and Nokia-Vodacom that cycles are of length 16ms and 256ms respectively.

Table 17: Table showing a summary of C-DRX values

	ZTE-MTN	Nokia-Vodacom
<b>Ublox</b>		
Peak current	73.6 mA	72 mA
Transmit time	12.8 ms	56 ms
Idle time	4 ms	200 ms
<b>Quectel</b>		
Peak current	70.4 mA	66.4 mA
Transmit time	12 ms	80 ms
Idle time	4 ms	180 ms

On the MTN-ZTE network the peaks indicate an on time of roughly 12ms and idle of 4 seconds. With a cycle of 16ms, it fits the LTE requirements of between 10ms and 2560ms in terms of 1ms subframes. However, NB-IoT has a minimum requirement of 256ms to 9216ms for the interval length between C-DRX transmissions and Vodacom-Nokia is using this minimum value. MTN-ZTE is utilizing vastly more time on air than permitted by the 3GPP and it is having a detrimental effect on the estimated battery life. Vodacom-Nokia is using the minimum, but it is recommended to increase this value. Lastly, this does not bode well for the

scaling up of devices due to the interference, especially on the shared uplink (NPUSCH) channel.

### 3.1.1.5 E-UTRAN Node B (eNB/eNodeB)

Ericsson eNodeBs run Linux and their commands are accessible via Moshell, or the scripting language AMOS.

To get an idea of the complexity of a node (eNodeB) in a base station (BTS), running `$ get .` in the terminal of B06009-TESTPLANT returned 7037 Managed Objects (MOs) with 27989 parameters. See Appendix H for an example code snippet of the first two Managed Objects. This highlights how easy it is for a BTS to produce different results in this study depending on the network configuration and environment.

### 3.1.2 Range Field Test

This gives a good idea as to the range expected according to RSRP, with more information in §3.3.4.6.

Using a Quectel BG96, the following tests were taken on the rooftop described in Fig. 3.3<sup>4</sup>.



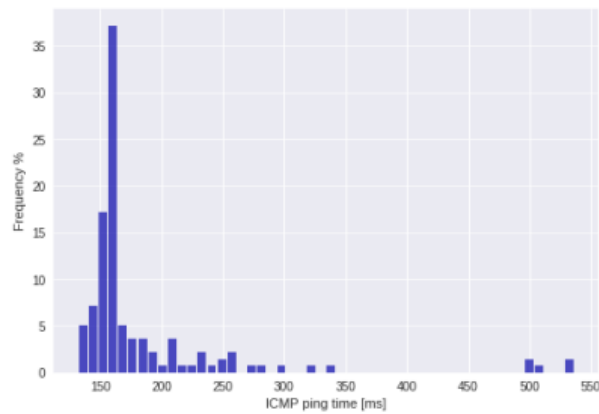
Figure 3.3: Rooftop outside the HF RF lab on the 5th floor of the Electrical & Electronic Engineering building. The base station it connected to is on the General Building, and is just over 150m away at the same elevation with a single building blocking line-of-sight. The base station is situated on the bottom left of the picture at an altitude of approximately 138m.

The tests involve sending a set of 10 pings multiple times at a certain attenuation and resulting RSSI measurement using a Quectel BG96 modem.

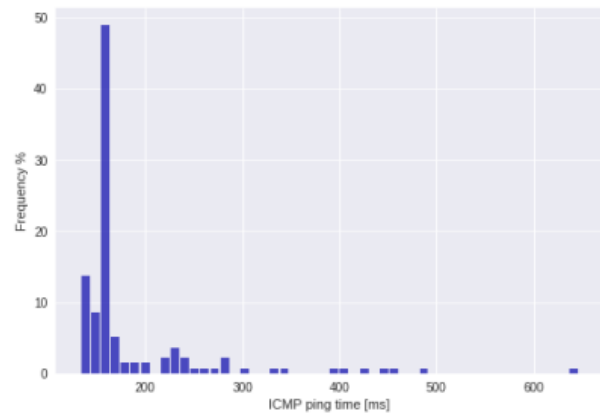


Figure 3.4: Looking at the ICMP ping response according to different RSSI values, we see high jitter of a few seconds from -80dBm or less. This means that in an urban area, NB-IoT satisfies the 2-5 km range specification.

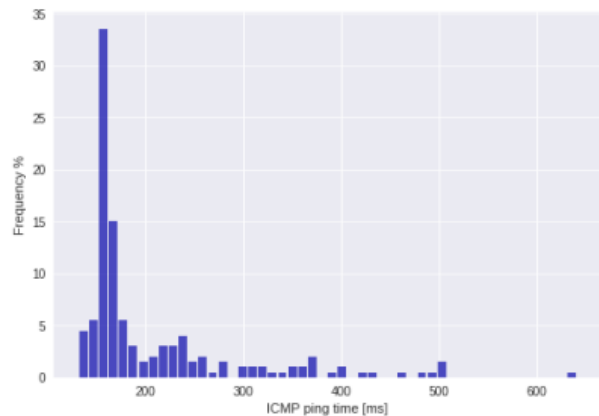
<sup>4</sup>The MTN-ZTE test dataset §3.7.1 was captured inside the RF enclosure inside the HF RF lab.



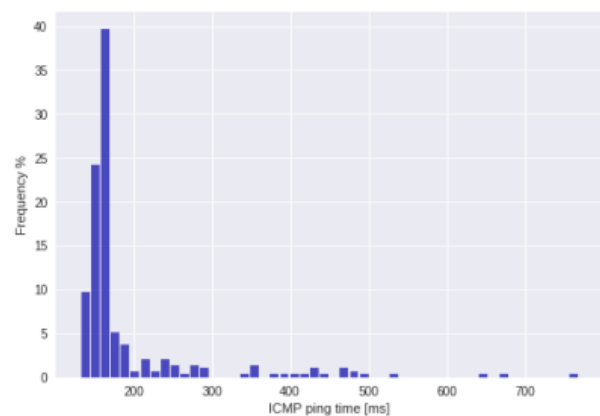
(a) 0 dB attenuation test in ECL class 0 at -51 dBm RSRP. With an antenna and the attenuator set to 0dB, we find most of the values around the mean of 185.2ms, except for the tail at around 500ms which is the time of the first ping in a set of 10.



(b) 110 dB attenuation test in ECL 0, at -85 dBm RSRP. Setting the attenuator to the max of 110dB, we see no change in the ping measurements which have a mean of 185.9ms. The tail has increased to a max of just over 600ms.



(c) Attenuator and no antenna test in ECL 0 at -91 dBm RSRP. Removing the antenna from the attenuator, we find that the data has a slightly thicker tail, and averages around 207.1ms.



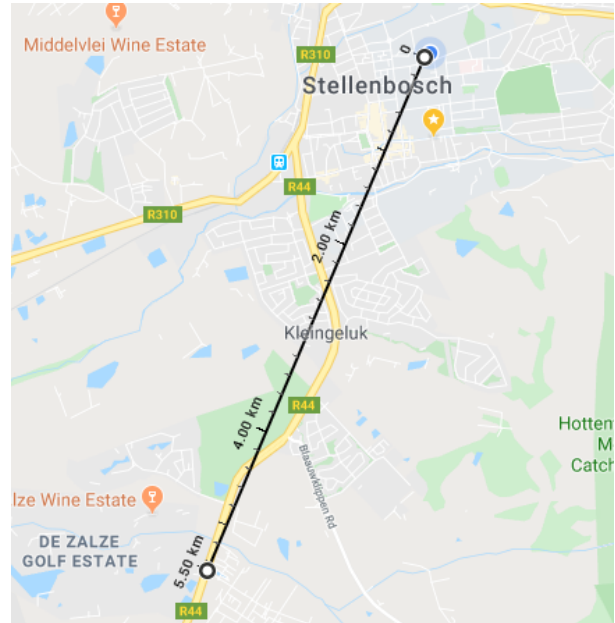
(d) No attenuator and no antenna test in ECL 1 at -107 dBm RSRP. Lastly, having no attenuator nor antenna we still have a connection at -107dBm with a mean of 190.6ms.

Figure 3.5: Ping tests on Engineering rooftop with time in milliseconds on x-axis and the percentage frequency on the y-axis. Here we see how ECL class 0 and ECL class 1 is quite similar.

To be able to attenuate the signal until disconnection, one must increase the range from the base station such that leakage transmission from traces, soldering and attenuator connectors do not interfere with the test. As such, there must not be a connection to the base station at all if the antenna or attenuator is disconnected or connected at maximum attenuation.

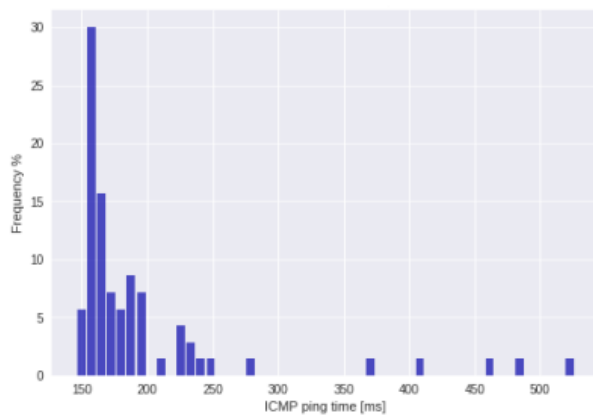


(a) A test was performed from 10pm onwards at Technopark on 14 March 2019. A connection was made at a range of 4.8 km at -93dBm and an altitude of 132m. This is a relative elevation of -6m to the base station.

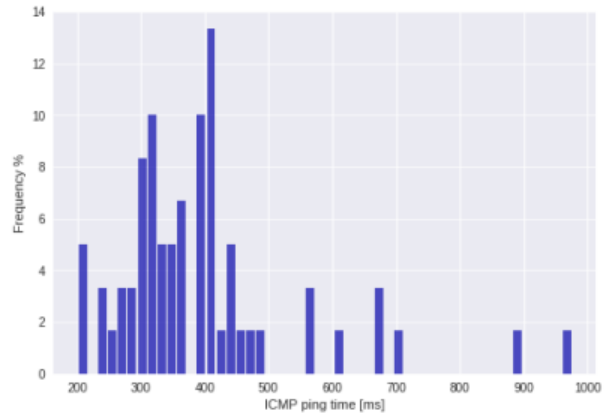


(b) The greatest distance measured was 5.5km from the intersection of the R44 and the turn-off to Stellenbosch Square or Jamestown at an altitude of 106m. This is a relative elevation of -32m to the base station and at an RSRP of -89dBm.

Figure 3.6: Long-distance tests were performed, and these two maps show the maximum distance that signals travelled.

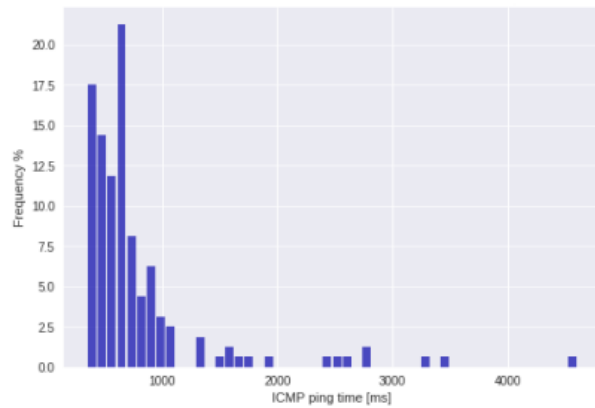


(a) 0 dB attenuation test in Technopark at -93 dBm RSRP in ECL class 0. With no attenuation, the data has a mean of 196.7ms and a tail just above 500ms.

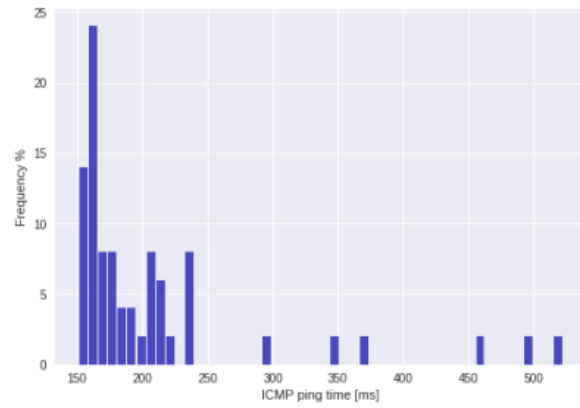


(b) 10 dB attenuation test in Technopark at -101 dBm RSRP in ECL class 1. In this condition, the data is more spread out from 200 - 500ms with a mean of 396.4ms and a tail at just under 1000ms.

Figure 3.7: Long-range ping tests in Technopark starting from 0 dB attenuation and adding 10 dB.

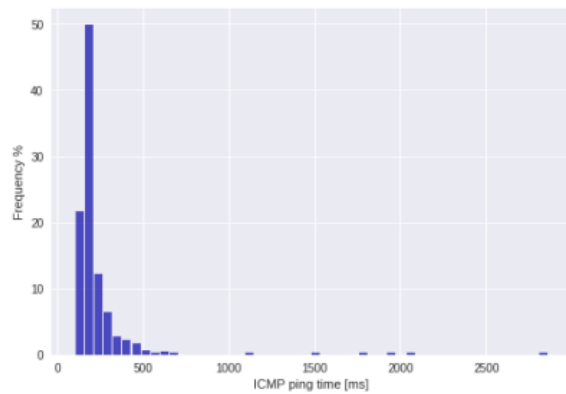


(a) 20 dB attenuation test in Technopark at -107 dBm RSRP in ECL 2. At 20dB attenuation, the data is more spread across 350 - 1000ms with a mean of 793.4ms and a tail that extends to over 4500ms. Any more attenuation and the signal is lost.

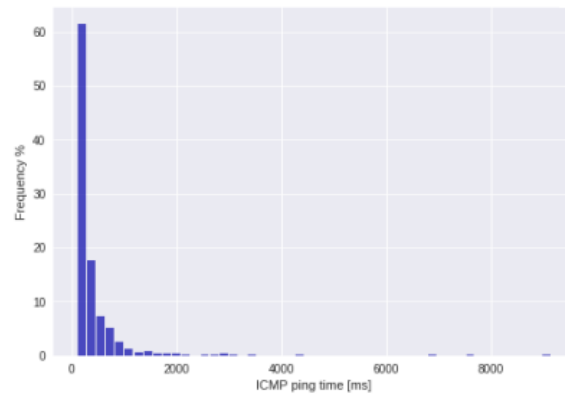


(b) 0 dB attenuation test at Stellenbosch Square R44 intersection at -89 dBm in ECL 0. At the furthest point in Fig. 3.6b, the signal strength increased to -89dBm and resumed a mean of around 209.6ms with a tail around 500ms.

Figure 3.8: Long-range ping tests in Technopark up to 20 dB attenuation and at Stellenbosch Square R44 intersection not surviving more than 0 dB attenuation.



(a) 0 dB attenuation test at Parmalat at -87 dBm in ECL 0. A similar pattern was seen 3.0 km away from the base station at Parmalat, although driving closer there were a few spots where connection was lost or many retries were needed such that the tail extended up to almost 3000ms for the ICMP ping time.



(b) Lastly, all the test data (including on the way to Technopark and back), we see a similar form except with a tail extending to almost 10 seconds, which is within 3GPP specifications.

Figure 3.9: Long-range ping tests show a few results at ECL class 2, which shows how different ECL class 2 from class 1 and 0, with the differentiating factor being a couple of seconds latency as opposed to a few hundred milliseconds. and thus a factor 10 difference.



### 3.1.3 RF Spectrum Tests

Using an RTL2832 SDR dongle, we can capture RF signals. At the very least we can visualise how the signal propagates through the airspace.

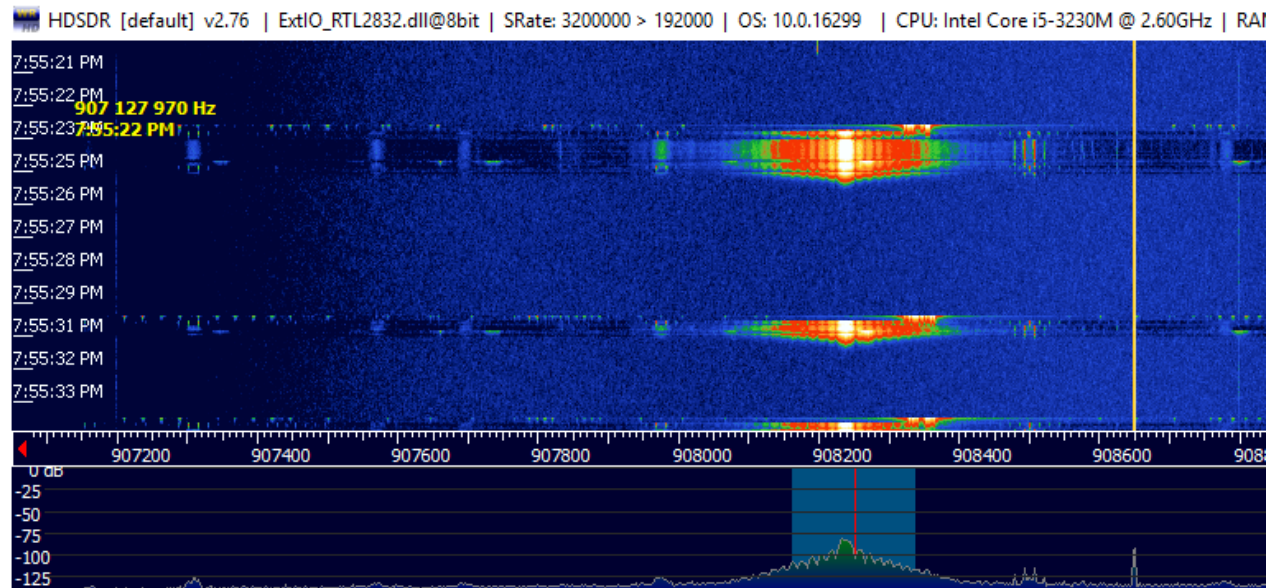


Figure 3.10: 5 dB SINR NB-IoT transmissions using Sierra Wireless WP7702 at 908.2 MHz and EARFCN 3734 of length 2282ms, 1560ms and 1380ms respectively.

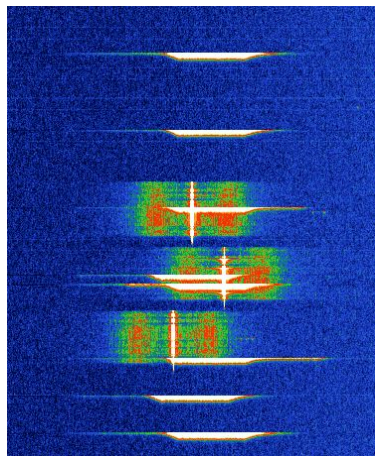


Figure 3.11: SigFox and LoRa RF signals @868 MHz on a waterfall diagram, with the x-axis showing frequencies at 868 MHz and the y-axis over time. The SigFox signals (vertical) take about 2 seconds to transmit, and the LoRa signals (horizontal) take a few hundred milliseconds.

Each technology has their own modulation scheme and unique features, and with that their own set of advantages and disadvantages. More can be found in §2.3.

### 3.1.4 Power Saving Mechanisms

This section shows a brief investigation into the power saving mechanisms of NB-IoT as mentioned in §3.1.4.

With a paging time window interval of 2.54s and 4 hyper-frames making up 40.96s, the following output is obtained.

```
AT+NPTWEDRXS=2,5,"0001","0011"
+CEREG: 5,1,"8CA7","28C464",7,,,"00011000","00101010"
```

AT+CEREG says that the T3324 active time is 48 seconds, or 2 seconds \* 24 binary coded timer value. This is not the expected outcome, even according to “Table 10.5.5.32/3GPP TS 24.008: Extended DRX parameters information” as referenced in Ublox documentation, which expects 40.96s. Besides, the paging time interval is also not working as expected as in Figure 3.19a.

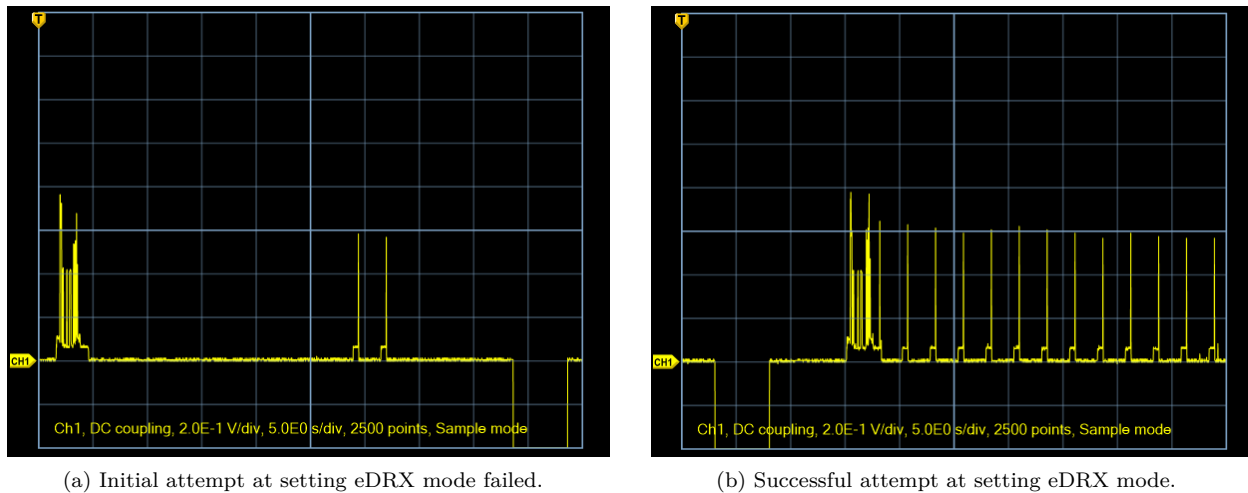


Figure 3.12: eDRX tests

The T3324 active timer value is then modified to 5.12s as in Figure 3.19b.

```
AT+NPTWEDRXS=2,5,"0001","0000"
```

AT+CEREG says that the timer is 32s, or 2 seconds \* 16 binary coded timer value.

```
+CEREG: 5,1,"8CA7","28C465",7,,,"00010000","00101010"
```

In the debug logs we see the timer expires after exactly 30 seconds.

```
1400,00:07.952393,NAS_DBG_TIMER
  action=TIMER_START
  prim_id=USIM_STATUS_TIMER_EXPIRY
  duration=30
2092,00:37.952728,USIM_STATUS_TIMER_EXPIRY
  timer_handle=16871576
```

Increasing the T3324 active timer value to 10.24s, the following results are obtained. It is exactly the same as before.

```
AT+NPTWEDRXS=2,5,"0001","0001"
```

AT+CEREG says that the timer is 32s, or 2 seconds \* 16 binary coded timer value.

```
+CEREG: 5,1,"8CA7","28C465",7,,,"00010000","00101010"
```

In the debug logs we see the timer expires after exactly 32 seconds.

```
2409,+00:00.400757,NAS_DBG_TIMER
  action=TIMER_START
  prim_id=USIM_STATUS_TIMER_EXPIRY
  duration=30
5981,+00:33.283905,USIM_STATUS_TIMER_EXPIRY
  timer_handle=16871576
```

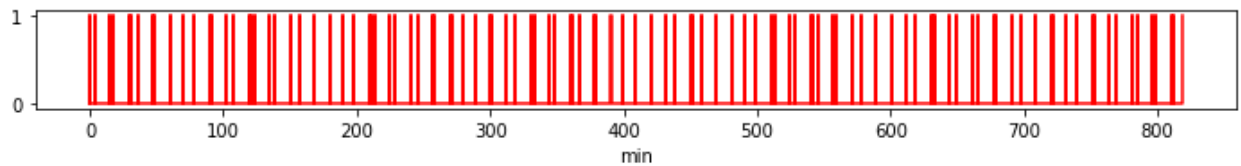


Figure 3.13: This test shows eDRX events until 800 minutes, measured externally. It shows an irregular eDRX time when not properly configured.

It is important to note that if eDRX time is not configured properly, then the outcome does not show as expected as in Fig. 3.13.

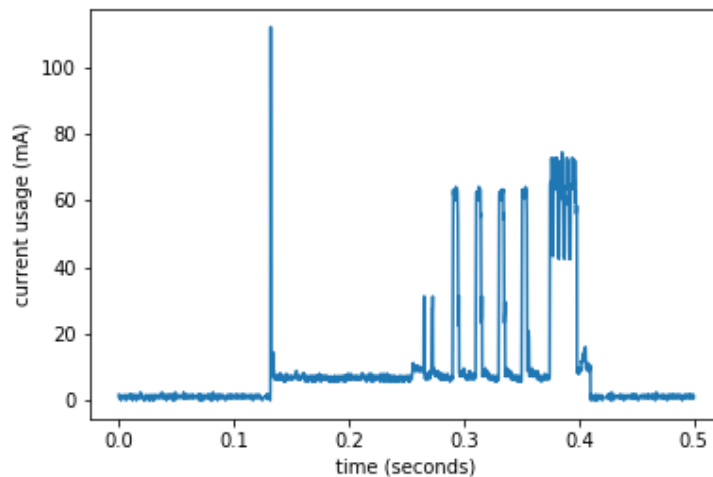


Figure 3.14: Typical eDRX current profile with a 277.8 ms duration. This shows how for the first few microseconds there is a large transmission current spike to synchronize, before receiving paging information from the cell tower.

Considering an eDRX event with a typical current profile as shown in Fig. 3.14, the debug trace shown here every 2.56 seconds for ZTE (same for Ericsson and Huawei but Nokia has a cycle every 10 seconds), shows the following information. Besides logs showing time synchronization and other network information, the serving cell logs show signal strength metrics.

```
102332,03:20.082306,LL1_EXIT_LOW_POWER_MODE
102334,03:20.082367,LL1_LOG_FAST_FORWARD_TIME_CALC
102360,03:20.165100,LL1_RESYNC
102362,03:20.165222,LL1_TIMING_ADJUST_LPM_WAKEUP
102364,03:20.165344,LL1_LOG_CURRENT_TIME_CALC
102370,03:20.205993,PROTO_LL1_SERVING_CELL_MEASUREMENT_IND
102372,03:20.206054,LL1_NRS_MEASUREMENT_LOG
```

```
102377,03:20.206573,LL1_LOG_CURRENT_TIME_CALC
102378,03:20.206665,LL1_CALC_PAGING_DATA
102381,03:20.207062,LL1_KV_CACHE_FLUSH
102382,03:20.207123,LL1_ENTER_LOW_POWER_MODE
102384,03:20.207336,LL1_SERVING_CELL_MEAS_IND
102385,03:20.207458,RRC_DBG_RESELECTION_MEASUREMENTS
```

### 3.1.5 Ultra-low Current Sleep Measurements

During deep sleep, UE devices typically use only a couple of microamps.

Using an MX 58HD DMM, one can measure the microamp sleep currents of UE devices. Testing the accuracy of the DMM, 4.501 mA is measured through a 4615 ohm resistor at 21.15V. Theoretically it should be 4.582 mA so that gives an error tolerance of 1.82% or ~2%.

The Ublox device consumed about 3.6 uA, and Quectel consumed 4.2 uA, which is close to manufacturer specifications.

### 3.1.6 Mobility Tests

There was a brief test done on mobility to show how NB-IoT devices can transition to different radio access technologies (RATs).

The Sierra Wireless 7702 has a Qualcomm 9206 modem which supports LTE Cat M1, NB1 and EC-GSM. Using a Sierra Wireless WP7702 on Ericsson Test BTS ‘L06009A3’ and EARFCN 3734/3752, the UE had to periodically ping an internet-facing server and the dead time was measured before it reconnected and received a response. The RSRP was in the range -50 to -80 dBm and in ECL 0. The tests took place within a faraday cage to isolate the test network from the live RAN, else by opening the door of the faraday cage it deregistered from the network and MME.

Table 18: NB-IoT and LTE Cat-M handover.

Mobility test	Time
Standalone to In-band	~ 11 s
In-band to Standalone	~ 11 s

### 3.1.7 Throughput

An initial throughput test was performed *not* using AT commands, but a linux script.

NB-IoT downloading was tested on the Sierra Wireless 7702 using the following script.

```
while [ 1 ]; do
  # wget --retry-connrefused --waitretry=1
  # --read-timeout=20 --timeout=15 -t 0 --continue
  wget -t 0 -c http://speedtest.ftp.otenet.gr/files/test100k.db
  # check return value, break if not successful (0)
  if [ $? != 0 ]; then break; fi;
  sleep 1s;
done;
```

A 100 kb file is downloaded at a rate of around 3kB/s. The script continues download if stalled or other errors occur. Since it is a Yocto installation<sup>5</sup>, the other `wget` arguments were not available.

<sup>5</sup>It's not an embedded solution. Rather, it creates a custom one for you, regardless of hardware architecture [45].

Table 19: Table showing preliminary throughput tests for GPRS, NB-IoT and LTE-M

	Uplink	Downlink
GPRS	158 kbps	254 kbps
NB-IoT	56 / 65 kbps	24 / 27 kbps
LTE-M	293 / 375 kbps	264 / 300 kbps

The Sierra Wireless 7702 is a powerful board, and it showed satisfactory throughput rates.

### 3.2 Example Application

An example application was built to test and understand NB-IoT. See schematic and board layout in Appendix D. The board includes not just NB-IoT but also LTE Cat-M, GPRS/EDGE, SigFox, LoRa, and Dash7. Initially designed to compare LPWANs, it was decided to focus more purely on NB-IoT as there is a great deal of variability among UEs and LTE vendors already.

Notable components include:

- Quectel BG96 cellular modem
- Murata CMWX1ZZABZ-078 which includes STM32L072CZ microcontroller and SX1276 transceiver
- Atmel SAMD21G18a microcontroller
- Microchip MIC29302WU 3A LDO Regulator @3.8V

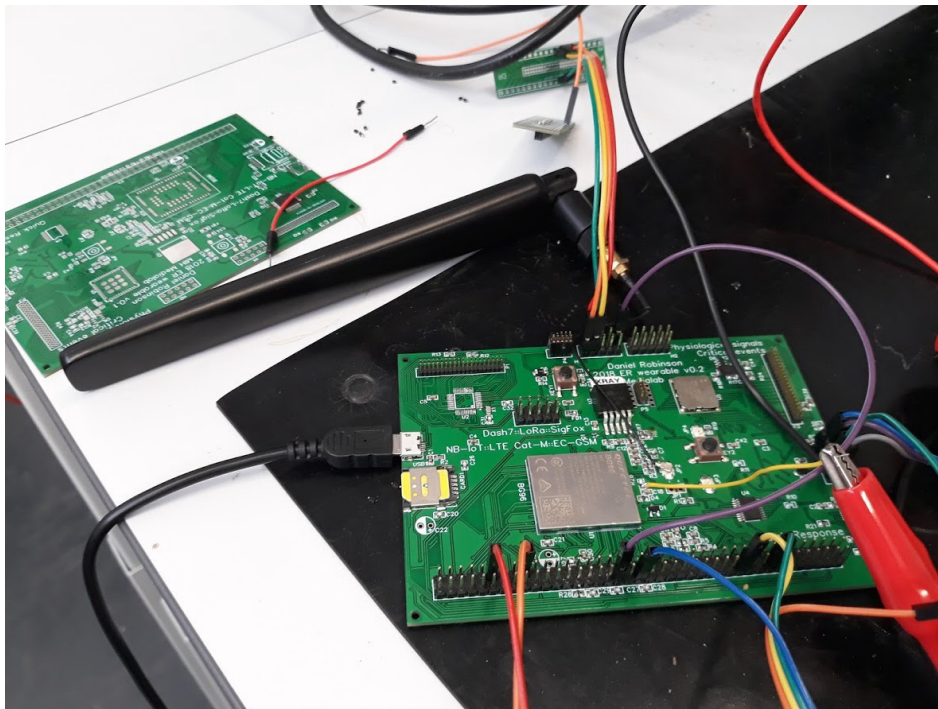


Figure 3.15: This is a PCB application developed as an example.

By adding a DHT22 temperature and humidity sensor, button and buzzer for an example application, we see the following dashboard result in Fig. 3.16.

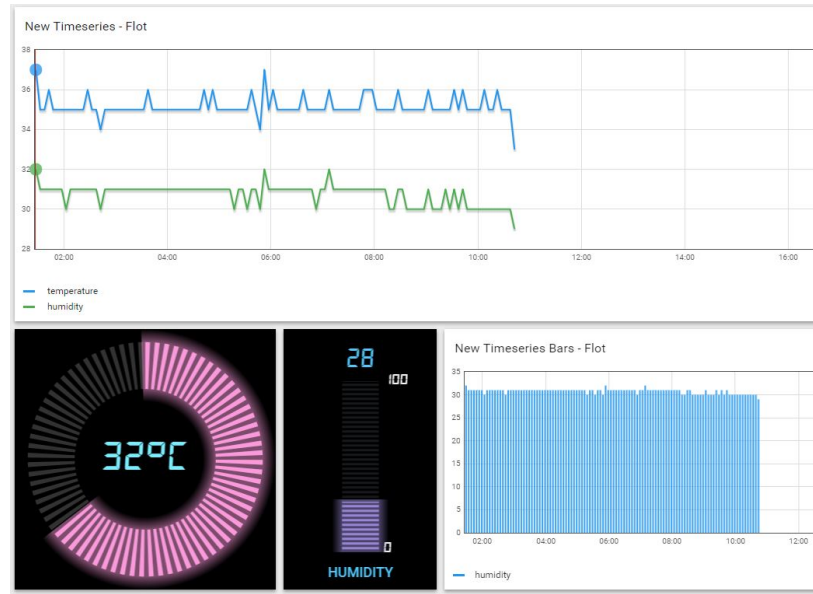


Figure 3.16: Dashboard showing communication between NB-IoT PCB and Thingsboard cloud via MQTT with temperature, humidity, push button and downlink buzzer control

Luckily UE manufacturers usually provide a development kit with open source schematics and board layouts. This study will use development kits so that tests are easily reproducible.

### 3.3 Setup Procedure

Each field test will make use of various UE hardware and telemetry tests and this section outlines the steps taken to perform these field tests.

#### 3.3.1 Hardware

This section outlines some of the hardware configurations required for field test captures.

##### 3.3.1.1 Attenuator

Two of these will be used in series: the HP8494B and the HP8496A. One has a range of 11dB in 1dB steps, and the other has a range of 110dB in 10dB steps, so it is possible to get a full range of 110dB in 1dB steps.

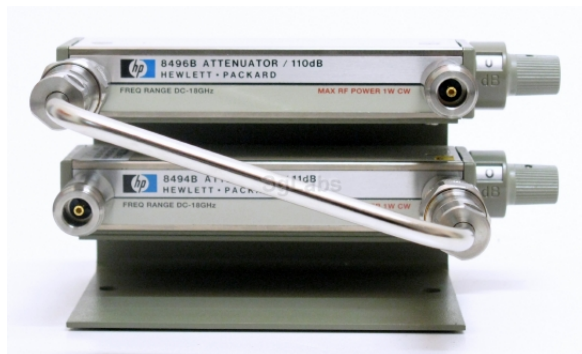


Figure 3.17: The Hewlett Packard attenuators used in this study to change the RF conditions for UE devices against multiple LTE vendors

The 1 dB attenuator is useful to attenuate the signal strength until the RSRP is on a decade multiple of 10. This way variation around the decade is more visible.

### 3.3.1.2 Current Measurements

By measuring current, the field tests can measure the energy usage of each datagram packet.

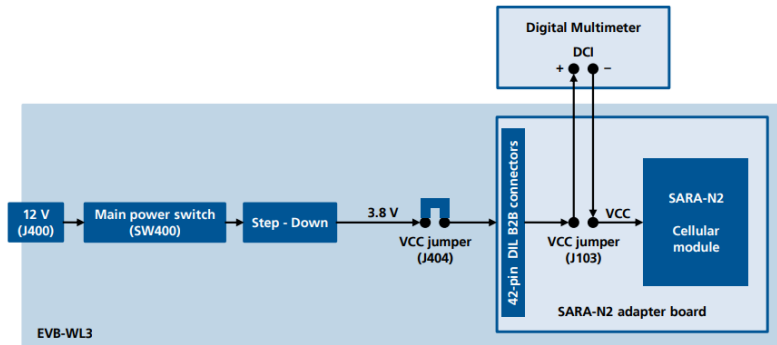
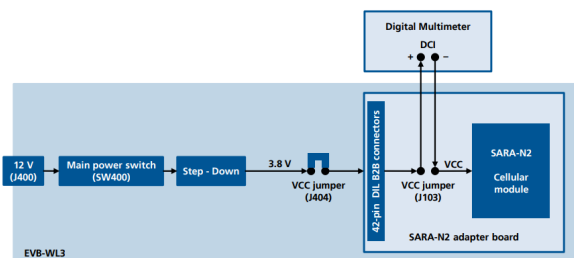
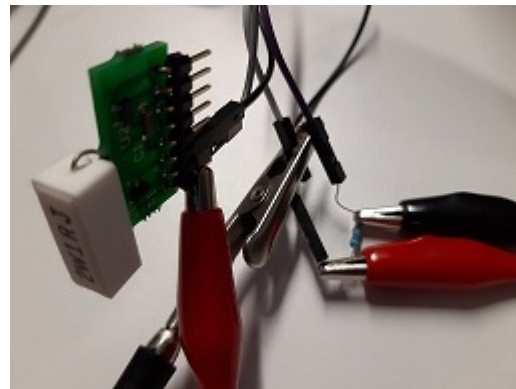


Figure 3.18: Block diagram of current consumption setup for SARA-N2

The digital multimeter in Fig. ?? is replaced with a ZXCT1008 high-side current monitor in series with the modem.



(a) ZXCT1008 high-side current monitor schematic



(b) ZXCT1008 high-side current monitor in action

Figure 3.19: Diagrams show ZXCT1008 high-side current monitor which can be found on <https://www.diodes.com/assets/Datasheets/ZXCT1008.pdf>

$R_s$  is set to a 1 ohm resistor and  $R_g$  is set as a 1k ohm resistor such that 100mA supplied to the modem makes 1V.

$$V_{out} = I_{load}[mA] * 10 \left[ \frac{V}{mA} \right] \quad (4)$$

### 3.3.1.3 Energy Capture Device

The energy capture device measures the energy of each packet, and also returns the duration timings of each datagram packet for latency measurements.

PlatformIO compiles code for the microcontroller, and in this case it is a simple Atmel ATmega328P 8-bit microcontroller.

```
void energyLoop(boolean pause) {
  uint8_t reading = analogRead(A0);
  if (reading > 60) {
    if (reading > maxReading) maxReading = reading;
    if (!readCount++) {
      tStart = millis();
      idleTime = tStart - tEnd;
    }
    tEnd = millis();
    zeroM = tEnd;
    zeroCounter = 0;
    sum += reading;
    tStepCount += micros() - tStep;
  }
  else if (pause) zeroM = millis();
  else if (millis() - zeroM < 1000);
  else if (readCount) {
    txTime = tEnd - tStart;
    tStepCount /= 1000;
    energy = sum * 500 / 1023.0 * tStepCount / 1000 / 1000;

    buf.flush(); tx[0] = '\0'; // energyFlush();
    buf.print(idleTime); buf.print(",");
    buf.print(txTime); buf.print(",");
    buf.print(tStepCount); buf.print(",");
    buf.print(energy); buf.print(",");
    buf.println(maxReading/2);
    Serial.print(buf); // energyPrint();

    sum=idleTime=txTime=readCount=maxReading=energy=tStepCount= 0; // energySetup();
  }
  tStep = micros();
}
```

Code can be found on <https://github.com/daniel-leonard-robinson/masters/tree/master/code/edge/src>. It connects to the ZXCT1008 mentioned in §3.3.1.2 and converts the results to energy measurements. It also returns via serial to the PyTest framework the timings of each datagram packet.



### 3.3.2 Network Registration

Network registration is important before a device can send data to the internet. As mentioned in §1.4.1, the right SIM cards are necessary. It may even be possible to use e-SIMs as in Fig. 3.20.

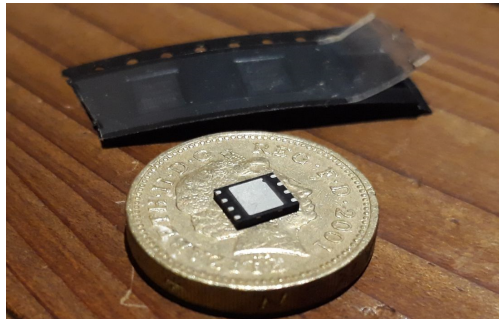


Figure 3.20: Hologram worldwide e-SIM

Finally, the right APNs are necessary. To use MTN’s test network, the APN `rflab` is used. On Vodacom’s network, the APN `nbiot.vodacom.za` is used.

### 3.3.3 PyTest Framework

A software framework was necessary to wrap AT commands into telemetry tests, include setup procedures.

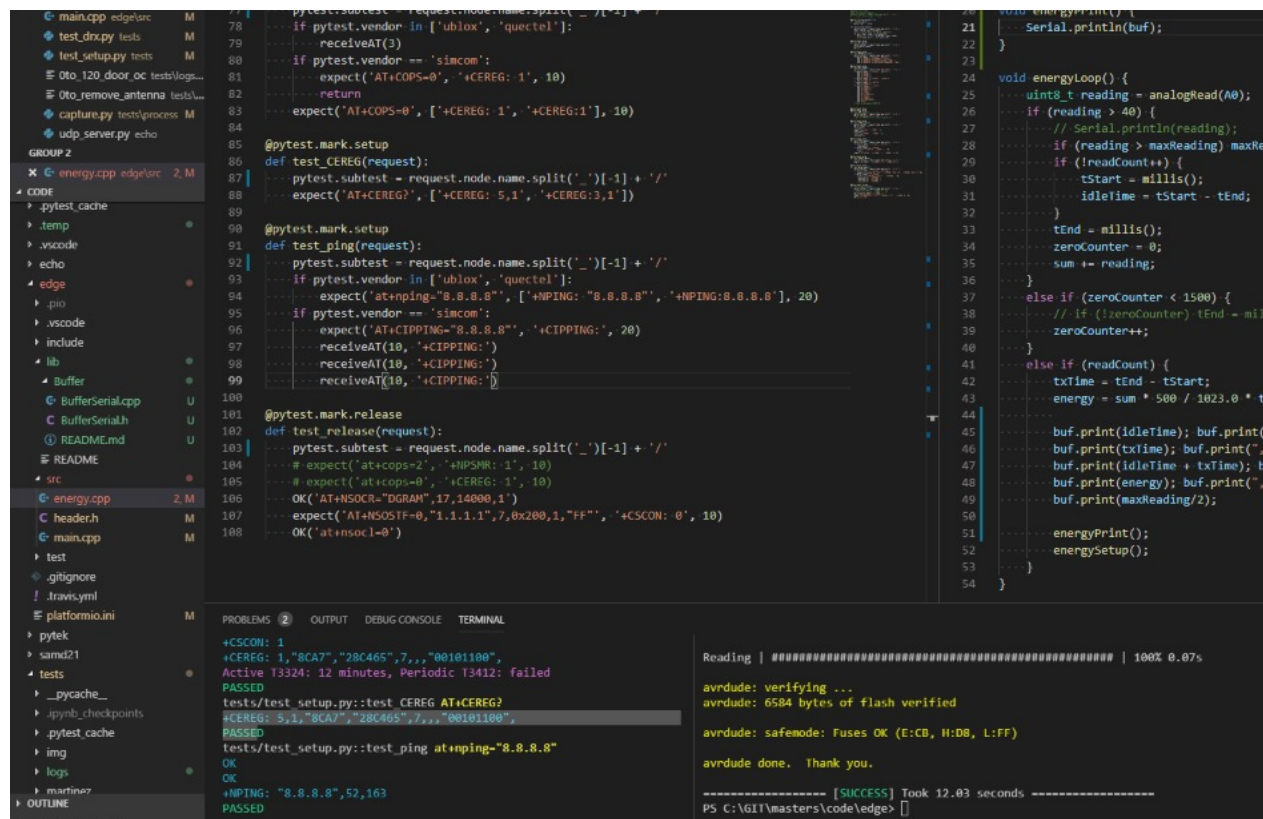


Figure 3.21: Python PyTest framework written in Microsoft VS Code and test output can be seen in bottom-left window. PlatformIO compiles microcontroller code and uploads via avrdude as can be seen in bottom-right window.

PyTest is a unit testing framework used to setup the UE for each test using AT commands and can be found on <https://github.com/daniel-leonard-robinson/masters/tree/master/code/tests>. Although the testing framework is quite extensive, a few snippets of code will be discussed in this section to at least give an idea to the reader how this was developed.

Every test fixture includes the following setup and teardown code to open a serial connection to the UE. It automatically detects the COM port based on the USB vid.

```
def serialOpen():
    # setup for each test fixture
    global serAT, serTIM, serGPS, AT_PORT, uC_PORT
    ATcount = 0
    ports = serial.tools.list_ports.comports()
    for port, desc, hwid in sorted(ports):
        vid_pid = hwid.split('=')[1].split()[0]
        if vid_pid == '2341:8036':
            uC_PORT = port
        if vid_pid == '0403:6010' and not ATcount:
            AT_PORT = port
            ATcount += 1
            pytest.vendor = 'ublox'
        if vid_pid == '04E2:1414' and ATcount < 3:
            AT_PORT = port
            ATcount += 1
            pytest.vendor = 'quectel'
        if vid_pid == '0403:6001':
            AT_PORT = port
            pytest.vendor = 'simcom'
    try:
        serAT = serial.Serial(AT_PORT, 115200, timeout=1)
        serTIM = serial.Serial(uC_PORT, 115200, timeout=1)
        serGPS = serial.Serial(GPS_PORT, 9600, timeout=1)
    except serial.serialutil.SerialException as e:
        print(e)

def serialClose():
    # tear down for each test fixture
    global serAT, serTIM, serGPS
    serAT.close()
    serTIM.close()
    serGPS.close()
```

The setup and teardown functions are defined in a global file that is imported into each file of test fixtures. The location for new data in the database depends on chosen manufacturer (LTE vendor), location, file description and connected UE. The file description is the current RF attenuation and ranges from 0 to 110.

```
def setup_module(module):
    serialOpen()
    pytest.manufacturer = 'huawei' # 'ericsson', 'nokia', 'zte'
    pytest.loc = 'mtn/testplant_14th/'
    pytest.descr = '110'
    # pytest.lock = threading.Lock()

def teardown_module(module):
    serialClose()
```

See Appendix G to see how a Quectel or Ublox modem is set up. Running the following commands in Table 20 will set the device up.

Table 20: PyTest setup commands to be run in terminal

<code>pytest -svm apn</code>	Runs set APN fixture
<code>pytest -svm setup</code>	Runs all the setup fixtures
<code>pytest -svm reboot</code>	Reboots device if necessary

The following commands are wrappers for sending and receiving AT commands:

```
def OK(cmd, t=0):
    reply = sendAT(cmd, t)
    assert 'OK' in reply
    return reply

def expect(cmd, reply, t=1, output=True):
    replies = reply
    if str(type(reply)) == "<class 'str'>":
        replies = [reply]
    data = sendAT(cmd, t, replies, output)
    if not len(replies[0]):
        return data
    check = False
    for r in replies:
        if len(r):
            if True in [r in i for i in data]:
                check = True
                break
    if not check:
        print(magenta + str(replies), data)
    assert check
    return data

def sendAT(cmd, t=0, expect=['OK'], output=True):
    if output:
        print(yellow + cmd)
    serAT.write(bytes(cmd + '\r', 'utf-8'))
    return receiveAT(t, expect, output)

def receiveAT(t=0, expect=['OK'], output=True):
    if str(type(expect)) == "<class 'str'>":
        expect = [expect]
    c = 0
    data = []
    exp = expect[:]
    exp.append('ERROR')
    exp.append('FAILED')
    while True:
        d = serAT.readline().decode('utf-8')
        if not len(d):
            c += 1
        d = d.strip()
        if len(d) > 0:
            if output:
                print(cyan + d)
            out = converter(d)
            if out:
                print(magenta + out)
```

```

    data.append(d)
    if t > 0:
        if c >= t:
            data.append('timeout')
            return data
    for e in exp:
        if e in d:
            return data

```

Finally, the testing framework has a `capture` command which is blocking until an energy capture event. In this event the energy is sent via serial from the energy capture device (§3.3.1.3) and triggers the testing framework to extract information from the `AT+NUESTATS="RADIO"` command.

```

def receiveTIM():
    data = {}
    serTIM.flush()
    d = serTIM.readline().decode('utf-8') # d = '2300,260,2560,10.0,100,'
    if len(d):
        try:
            d = d.strip() # print(magenta + d)
            data['idleTime'] = int(d.split(',')[0])
            data['txTime'] = int(d.split(',')[1])
            data['totalTime'] = int(d.split(',')[2])
            data['energy'] = float(d.split(',')[3])
            data['maxCurrent'] = float(d.split(',')[4])
        except (ValueError, IndexError) as e:
            print(red + d)
            raise e
    return data

```

### 3.3.4 Telemetry Tests

The telemetry tests measure various aspects of the required metrics. Running the following commands in Table 21 will run through the desired telemetry test.

Table 21: PyTest telemetry test commands to be run in terminal

<code>pytest -svm release</code>	UDP test for multiple payload sizes
<code>pytest -svk ptau</code>	Run PTAU test
<code>pytest -svk drx</code>	Run eDRX test
<code>pytest -svm reg</code>	Run COPS test
<code>pytest -svk echo</code>	Runs Echo test

#### 3.3.4.1 UDP

UDP is used primarily for establishing low-latency and loss-tolerating connections between applications on the internet.

To test the capability of sending to the internet for multiple UEs, a simple protocol is necessary. TCP, MQTT, CoAP and other protocols are all based on the same IP infrastructure that UDP uses, yet not all UEs have this capability. UDP will be used and other protocols can be tested against it.

This test sends a UDP packet to an internet accessible IP address. The IP is 1.1.1.1 and it belongs to Warp which claims to be the fastest DNS resolver in the world, with OpenDNS, Google and Verisign taking the next respective rankings.

As an alternative, data can be sent to the u-blox echo server at `udp://echo.u-blox.com`. Because there

is no DNS lookup function in the SARA-N2 module series, the server IP address that must be used is 195.34.89.241.

UDP datagrams are sent with payloads of size 1, 16, 64, 128, 256 and 512 bytes.

Here is a snippet of one of the test fixtures for Ublox sending a 16 byte UDP payload with Release Assistance flags set.

```
@pytest.fixture(autouse=True)
def _config(request):
    pytest.test = 'release/'

...
@pytest.mark.release
def test_release_release16(request):
    pytest.subtest = request.node.name.split('_')[-1] + '/'
    if pytest.vendor == 'ublox':
        expect('at+nsocl=0', '')
        receiveAT(1)
        for i in range(5):
            OK('AT+NSOCR="DGRAM",17,14000,1')
            expect('AT+NSOSTF=0,"1.1.1.1",7,0x200,16,"FFFFFFFFFFFFFFFFFFFFFFFFFFFFFFFF"',
                  '+CSCON: 0', 300)
            OK('at+nsocl=0')
            capture(1)
    ...
```

### 3.3.4.2 Periodic Tracking Area Update (PTAU)

This snippet sets up the eNodeB to schedule a PTAU event every 4 seconds (roughly ~5.5 seconds actual).

```
...
@pytest.fixture(autouse=True)
def _config(request):
    pytest.test = 'ptau/'

def test_ptau_set(request):
    pytest.subtest = request.node.name.split('_')[-1] + '/'
    setEDRX(4, 1, 0, 0, 3, 2) # 5.5 sec ptau
    capture(1)

def test_ptau_capture(request):
    pytest.subtest = request.node.name.split('_')[-1] + '/'
    capture(10)
```

### 3.3.4.3 Extended Discrete Reception (eDRX)

This snippet sets up the eNodeB to schedule a DRX event every 2.56 seconds.

```
...
@pytest.fixture(autouse=True)
def _config(request):
    pytest.test = 'drx/'

def test_drx_set(request):
    pytest.subtest = request.node.name.split('_')[-1] + '/'
    setEDRX(4, 1, 2, 5, 6, 2) # 2.56 continuous
    capture(1)
```

```
def test_drx_cap(request):
    pytest.subtest = request.node.name.split('_')[-1] + '/'
    capture(10000)
```

### 3.3.4.4 Cellular Operator Selection (COPS)

Network Registration is necessary when the device is not yet connected. In Figure 3.22, An initial test was performed with AT+COPS=0 network registration until T3412 timeout of 270 seconds and peak current approximately 70mA.

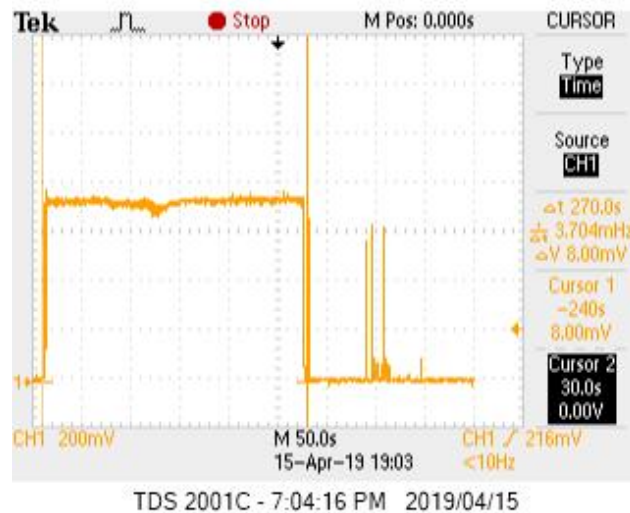


Figure 3.22: AT+COPS=0 network registration on MTN-ZTE network with lengthy inactivity timer setting of 270s.

This snippet registers the UE device on the network and as a workaround to shorten a long C-DRX inactivity timer of 10, 20 seconds or more (even up to ~265 seconds) it sends a UDP packet with a flag which tells the eNodeB that it would like to release the connection immediately, hence Release Assistance as mentioned in §??.

```
...
@pytest.fixture(autouse=True)
def _config(request):
    pytest.test = 'cops/'

##### reg release #####
@pytest.mark.reg
def test_cops_register2(request):
    pytest.subtest = request.node.name.split('_')[-1] + '/'
    flushTIM()
    expect('AT+CFUN=1', 'OK', 3)
    expect('AT+COPS=0', ['+CEREG: 1', '+CSCON: 0', '+CEREG:1', '+CSCON:0'], 300)

@pytest.mark.reg
def test_cops_release(request):
    pytest.subtest = request.node.name.split('_')[-1] + '/'
    fetchTIM()
```

```

if pytest.vendor == 'ublox':
    expect('at+nsocl=0', '')
    receiveAT(1)
    OK('AT+NSOCR="DGRAM",17,14000,1')
    receiveAT(1)
    expect('AT+NSOSTF=0,"1.1.1.1",7,0x200,1,"FF"', '+CSCON: 0', 100)
    OK('at+nsocl=0')
elif pytest.vendor == 'quectel':
    ...
    ...
    receiveAT(1)
    receiveAT(1)
    fetchTIM()
    capture(1, 3)

##### dereg release #####
@pytest.mark.reg
def test_cops_deregister(request):
    pytest.subtest = request.node.name.split('_')[-1] + '/'
    OK('AT+COPS=2', 5)
    receiveAT(300, ['+NPSMR:'])
    flushTIM()
    capture(1, 20)
    ...

```

### 3.3.4.5 Echo

This test is designed to measure client and server initiated echo requests. The custom echo server replies immediately, then waits 10 seconds before sending another reply, hence a server initiated echo. Unfortunately, the inactivity timer resets and a UDP datagram with the Release Assistance flag set has to be sent.

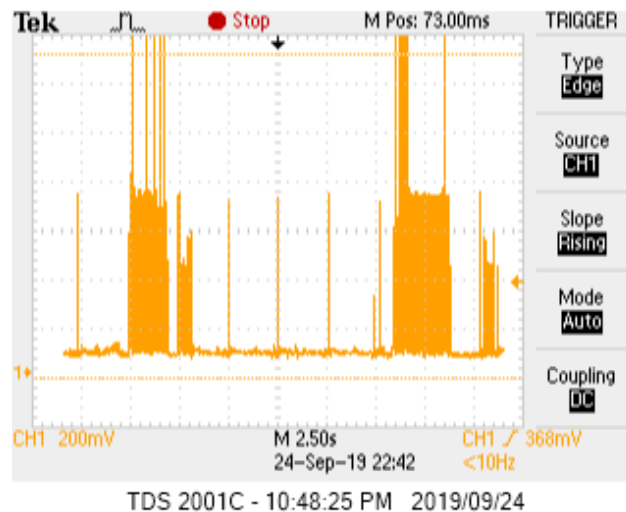


Figure 3.23: An oscilloscope measurement of the Echo test in progress. Notice the four DRX cycles before the second Echo response. Echoes worked successfully every time, and did not take another 2.56 seconds DRX cycle longer than the 10 second delay that the echo server induced.

The following snippet shows how the framework sends to a custom echo server (on Google Cloud) which responds immediately and then the echo server responds again after a ten second delay.

```
...
def test_echo_send(request):
    pytest.subtest = request.node.name.split('_')[-1] + ('512/' if big else '/')
    if pytest.vendor == 'ublox':
        expect('at+nsocl=0', '')
        receiveAT(1)
        OK('AT+NSOCR="DGRAM",17,4444')
        if big:
            expect('AT+NSOSTF=0,"34.74.25.60",5555,0x400,512,"33333333333333333333...
                ... 33333333333333333333 ... ..
                ...3333333"', '+NSONMI: 0', 300)
        else:
            expect('AT+NSOSTF=0,"34.74.25.60",5555,0x400,3,"313232"', '+NSONMI: 0', 300)
            receiveAT(1, '+CSCON: ')
            OK('AT+NSORF=0,512', 3)
    ...
    capture(1, 8)
...
```

The custom echo server has a static IP (34.74.25.60) and is open on port 5555.

```
...
def receive_next(sock):
    "Repeatedly tries receiving on the given socket until some data comes in."
    logger.debug("Waiting to receive data...")
    while True:
        try:
            BUFFER_SIZE = 4096 # the buffer for receiving incoming messages
            return sock.recvfrom(BUFFER_SIZE)
        except socket.timeout:
            logger.debug("No data received yet: retrying.")
            pass

def receive_and_send_one(sock):
    "Waits for a single datagram over the socket and echoes it back."
    input_data, addr = receive_next(sock)
    message = input_data.decode()
    output_len = sock.sendto(input_data, addr)
    sleep(10) # 10 second delay before echoing back again
    output_len = sock.sendto(input_data, addr)

def start(args):
    "Runs the server."
    sock = socket.socket(socket.AF_INET, socket.SOCK_DGRAM)
    sock.settimeout(5) # seconds
    sock.bind((args.host, args.port))
    logger.info("Listening on %s:%s.", args.host, args.port)
    try:
        for i in itertools.count(1):
            receive_and_send_one(sock)
    ...
```



### 3.3.4.6 Ping

The +NPING AT command can be issued to check if the module is able to send and receive data via the internet, or an internal network location. To ping Google's DNS server: AT+NPING="8.8.8.8"

The information text response to the +NPING AT command will be issued after a few seconds. If the information text response is +NPINGERR: 1, the ping has timed out (usually within 10 seconds). The first ping might fail because it can take a few seconds to connect to the base station. Use the +CSCON URC to show when the module is connected.

Whilst the simple Ping command is useful to measure connectivity and latency, it unfortunately has no way to release the inactivity timer by itself, which means the modem continues to consume current in receive-mode/C-DRX. That is why the Echo telemetry test was designed.

## 3.4 Primary Metrics

Primary metrics power efficiency and latency are investigated as mentioned in §1.2. Primary and secondary metrics have a few preliminary tests performed using Ublox and Quectel devices on MTN-ZTE and Vodacom-Nokia networks.

### 3.4.1 Power Efficiency

Power efficiency is one of the main metrics focused on in this study. This section outlines a few preliminary tests and the design for the final field tests comparing UEs and MNOs. Low power consumption is vital for battery longevity up to ~10 years or more. Power consumption is affected by various factors. In the hardware design, PCB layout, antenna matching and location will have an effect on the overall interference received by the module, SINR and ultimately transmit power. Transmit power also depends on the range and path loss to the UE device. With a weak signal, more repetitions are required, hence ECLs in §\ref{ECLs}. Other power saving mechanisms such as release assistance, PSM and eDRX mode work together to extend battery life as in §\ref{power-saving-mechanisms}.

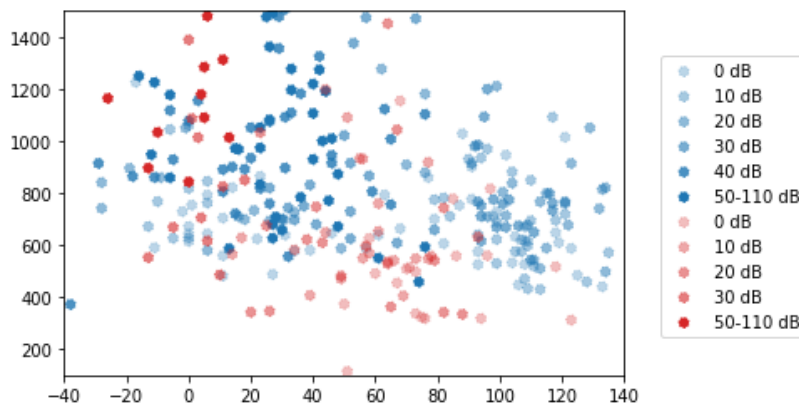


Figure 3.24: Ublox (blue) and Quectel (red) energy (J) per datagram as a function of the SINR (dB) as reported by the UE on the MTN-ZTE network limited to 1500 mJ. With the fading colour scheme and range just as in Martinez [2], Fig. 3.24 shows the impact of SNR on energy consumption. As observed in the figure, there is a trend of increasing energy with respect to lower SNR levels and high variability. Unfortunately, the effect of different ECLs is unclear.

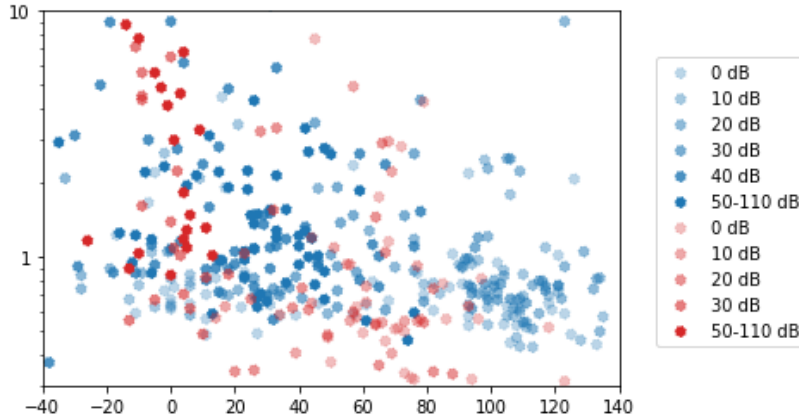
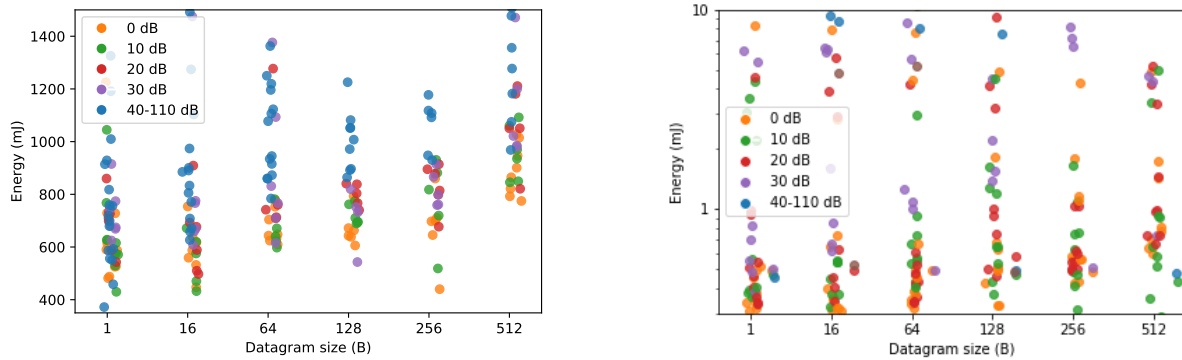


Figure 3.25: Ublox (blue) and Quectel (red) energy (mJ) per datagram as a function of the SINR (dB) as reported by the UE on the MTN-ZTE network. Increasing the range fully and using logarithms in Fig. 3.25, one can see that there is significant overshoot on the MTN-ZTE network. The trend mentioned in Fig. 3.24 continues.



(a) Datagram sizes of MTN-Ublox pair up to 1500 mJ.

(b) Datagram sizes of MTN-Quectel pair up to 10 J

Figure 3.26: UDP Datagram energy for different datagram packet sizes. Note the steady increase in energy consumption on the baseline, and the high variation. Although there is a slight trend in Fig. 3.26, it is not significant compared to the total variation for each datagram packet size.

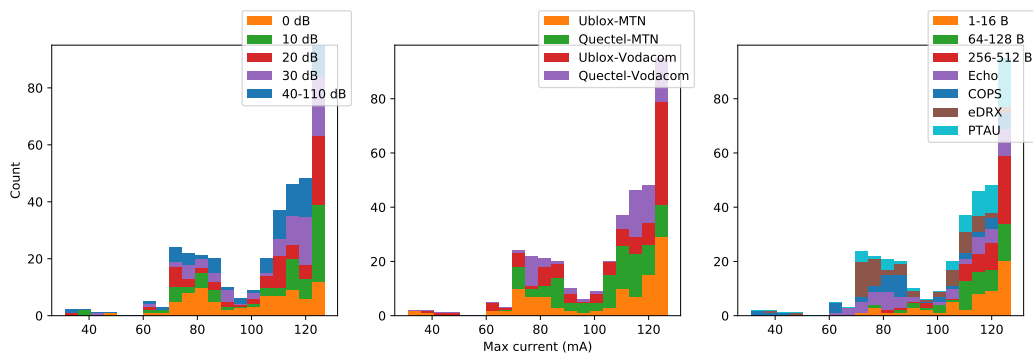


Figure 3.27: Peak energy measurements from roughly 70mA and skewed towards 128mA. These high peak energies shouldn't affect the average power much as peak current occurs only during the first few microseconds of the random access preamble (PRACH).

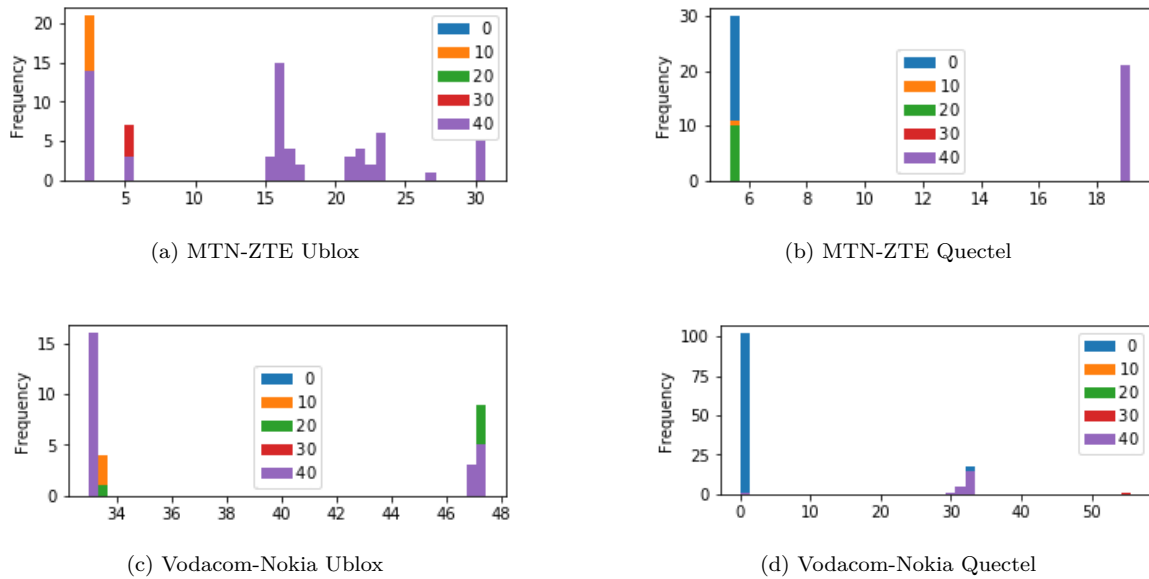


Figure 3.28: eDRX histograms of the energy produced by listening for paging occasions with respect to RF attenuation in dBm as mentioned in §2.5.5.3. Martinez [3] measured values under 10mJ for both Ublox and Quectel, yet on the MTN-ZTE and Vodacom-Nokia networks it is up to 5 times more. Thus, it is apparent that network configuration is the cause of these differences.

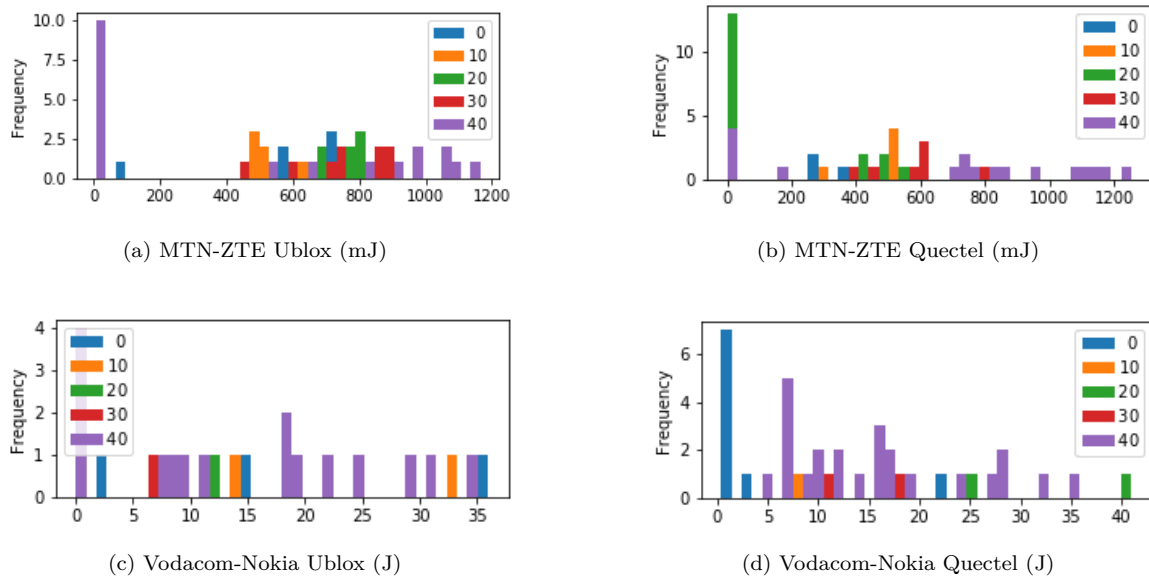


Figure 3.29: PTAU histograms of the energy produced when periodically updating UE devices and networks with tracking area IDs as mentioned in §2.5.5.1. PTAU uses about 20-100 times more power than eDRX for MTE-ZTE and up to 4000 times more energy on Vodacom-Nokia. Frequent PTAU updates should definitely be taken into consideration.

### 3.4.1.1 Average Power

Average power is either measured, or estimated by assuming the following conditions: voltage is 3.6 V, transmit current is 250 mA and receive current is set to 60 mA.

$$\text{Average Power} = P \cdot t = V \cdot I \cdot t = V \cdot (I_{TX} \cdot t_{TX} + I_{RX} \cdot t_{RX}) \quad (5)$$

### 3.4.2 Latency and Timing

Latency and timing is also one of the main metrics focused on in this study. This section outlines a few preliminary tests and the final design of field tests. Latency was measured externally using energy capture device (§3.3.1.3) and UE reported values. UE reported values are extracted from `AT+NUESTATS="RADIO"` and relevant variables include `TX Time` and `RX Time` which are expressed in milliseconds since boot. `TX Time` is the duration for which the modem has been transmitting RF signals. `RX Time` is the duration for which the modem's receiver has monitored the downlink channel for activity. Together these time values can be used to assess latency and estimate the power consumed by the module.

Initial network registration will show `RX Time` increasing as it scans for a BTS. Once found, `TX Time` will start to increase until successful registration.

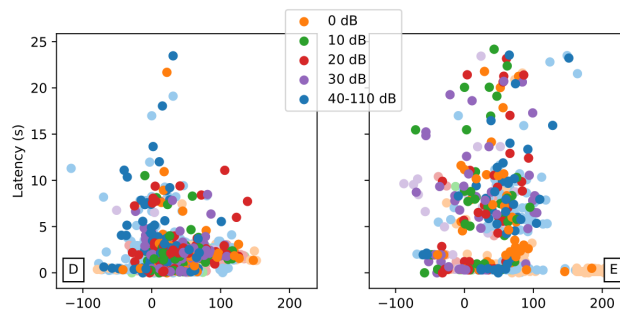


Figure 3.30: Latency per datagram as a function of the SINR (dB) as reported by the UE on the (D) MTN-ZTE and (E) Vodacom-Nokia network respectively. In Fig. 3.30, there is a poor distinction between attenuation zones as the SINR varies throughout the reported RSRP range. Grouping the data according to attenuation decade is important to see the effect of network conditions clearly.

## 3.5 Secondary Metrics

Secondary metrics, §1.2, are the metrics of interest which have less of an impact than power or latency, namely signal strength, throughput and data overhead.

### 3.5.1 Signal Strength

Signal strength is affected by range and path loss. It also affects the ECL class that the network chooses depending on the signal strength that UE devices report to the network. Therefore, it is important to observe characteristics across a range of values.

		RSRP (dBm)	RSRQ (dB)	SINR (dB)
RF Conditions	Excellent	>=-80	>=-10	>=20
	Good	-80 to -90	-10 to -15	13 to 20
	Mid Cell	-90 to -100	-15 to -20	0 to 13
	Cell Edge	<=-100	<-20	<=0

Figure 3.31: LTE RSRQ and SINR RF Conditions. Tests were completed in good, mid cell and cell edge RF conditions as these would be the most common values in the field showing the typical network characteristics and variation.

Signal strength can be measured or reported from the UE device and the following metrics are all related: MCL, RSRP, RSSI, RSRQ, SNR, TX Power and ECLs.

### 3.5.1.1 MCL

Maximum Coupling Link (MCL), as defined in §2.5.7.1 and by Eq. 2, is the greatest link between UE device and eNodeB. This can be calculated by using the minimum values of SINR obtained in the field capture datasets in §3.7.1, excluding outliers. Downlink SINR is calculated, because uplink SINR values as received on the BTS are unavailable.

$P_{TX}$  is set to 43 dBm.

Noise figure is defined as 5dB by 3GPP 45.820 7A [41].

With Bandwidth in Eq. 3 set to 180 kHz as defined in §2.3.3, Thermal Noise floor is equal to a value of -121.45 dB. Finally,  $P_{TX}$  is defined as

### 3.5.1.2 RSRP

Reference Signal Receive Power (RSRP) or “Signal Power” is an average power measurement of the received power level in an LTE network, via a single reference signal in dBm.

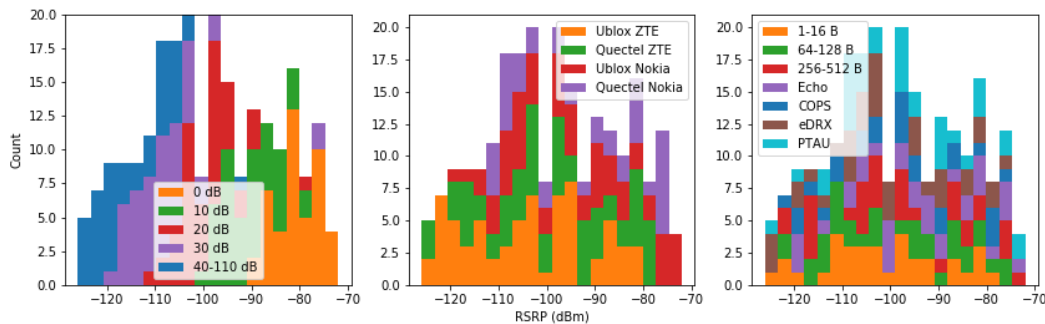


Figure 3.32: RSRP distribution using Ublox and Quectel UE on ZTE-MTN and Nokia-Vodacom infrastructure as well as attenuation and telemetry test set. RSRP and telemetry tests have a relatively even distribution, although RSRP still has about 20 dBm variability per attenuation decade. ZTE signals have higher MCL than Nokia.

### 3.5.1.3 RSSI

Received Signal Strength Indicator (RSSI) or “Total Power”, is the radio signal strength within the receive bandwidth. It usually combines the value of transmit power in the index. From this the signal to noise ratio (SINR) can be calculated.

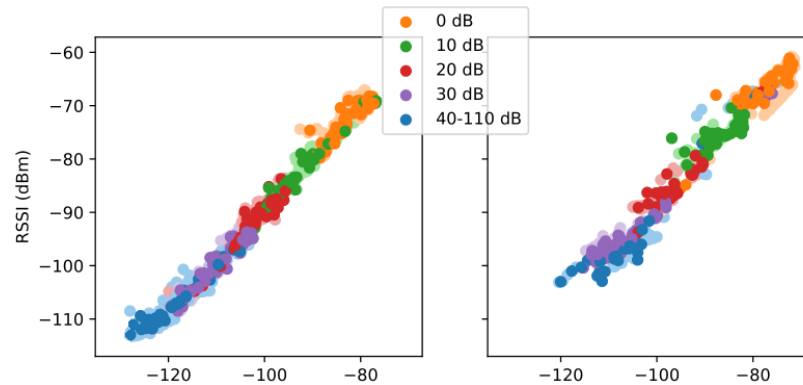


Figure 3.33: RSSI against RSRP for Ublox and Quectel devices (similar, thus combined) on MTN-ZTE (left) and Vodacom-Nokia (right). RSSI has a shorter ‘range’ than RSRP due to transmit power being included, and thus more information can be observed when comparing metrics against RSRP.

### 3.5.1.4 SINR

Signal-to-interference-plus-noise ratio (SINR) is a measure of signal quality. It is proprietary to LTE vendors since it is not defined in 3GPP specs, yet still widely used to better quantify the relationship between RF conditions and throughput.

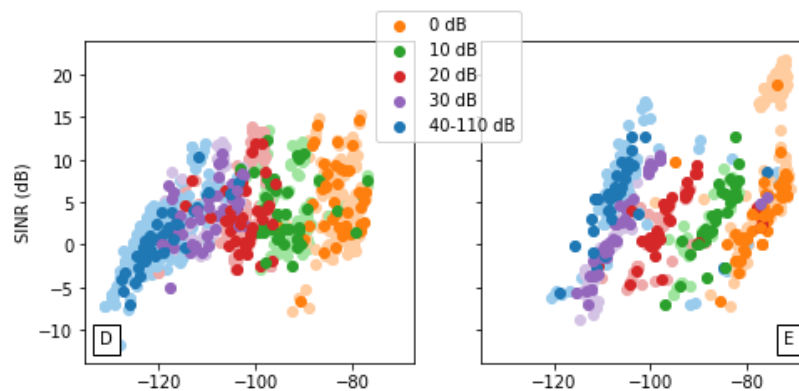


Figure 3.34: SINR against RSRP for Ublox and Quectel devices (relatively similar for now, thus combined) on MTN-ZTE (left) and Vodacom-Nokia (right). Each attenuation zone shows similar ranges of SINR, thus not as useful as RSRP when comparing other metrics against it. Ideally it should show a more linear relationship, and it is possible that these SINR readings are not accurate and contributing to variations in measured metrics.

Unfortunately, it has been implemented in various different ways which aren’t trivially comparable. For example, using a synchronization signal (based off a PCI assigned by eNodeB) instead of a reference signal in estimation already results in a different SINR [46].

**3.5.1.5 RSRQ**

Reference Signal Received Quality (RSRQ) is a measure of the quality of received power and is defined by Eq. 6.

$$RSRQ = N \times \frac{RSRP}{RSSI} \tag{6}$$

Reported value	Measured quantity value	Unit
RSRQ_00	RSRQ < -19.5	dB
RSRQ_01	-19.5 ≤ RSRQ < -19	dB
RSRQ_02	-19 ≤ RSRQ < -18.5	dB
...	...	...
RSRQ_32	-4 ≤ RSRQ < -3.5	dB
RSRQ_33	-3.5 ≤ RSRQ < -3	dB
RSRQ_34	-3 ≤ RSRQ	dB

Figure 3.35: LTE RSRQ reporting range defined from -3...-19.5dB

In Eq. 6, N is the number of Physical Resource Blocks (PRBs) over which the RSSI is measured, typically equal to system bandwidth, and RSSI is defined as above.

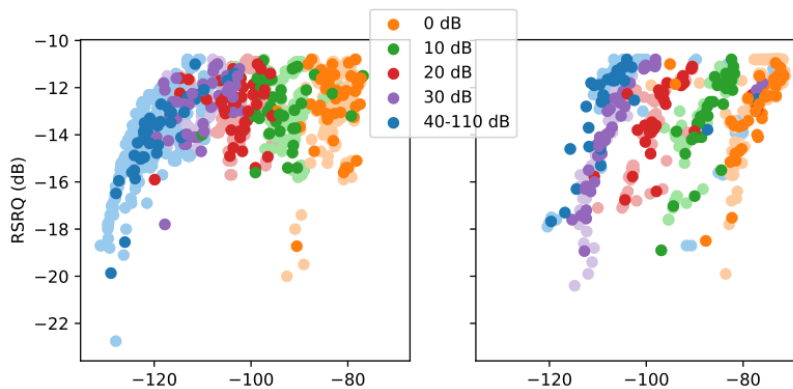


Figure 3.36: RSRQ against RSRP for Ublox and Quectel devices (similar, thus combined) on MTN-ZTE (left) and Vodacom-Nokia (right).

**3.5.1.6 Transmit power**

Transmit power is the RF power output from the modem. It should be a lower number if within good coverage. Modems would typically consume ~230 mA for +23 dBm.

**3.5.1.7 ECLs**

ECLs are equivalent to “PRACH coverage enhancement level” defined in 3GPP 36.321 [3] sub clause 5.1

As observed in §3.1.1.2, ECLs seem unaffected by RSRP. Due to repetition, it should have an impact on energy consumption and latency.

### 3.5.2 Throughput

Data can be extracted from UDP packet transmissions using latency and data size as in Eq. 7.

$$THP = \frac{Datagram\ Size}{Latency} \quad (7)$$

However, the UE reports RLC and MAC uplink and downlink separately, and therefore this will be used as these will be close to the theoretical maximum throughput of the UE device.

#### 3.5.2.1 FOTA Upgrades

GPRS and NB-IoT are able to offer FOTA upgrades to IoT devices, as Sigfox has limited bandwidth. This feature is supported by LoRaWAN, through the fragmentation of large payloads [22]. Since no correlation was found by Durand [1] with respect to downlink throughput and received signal power, that downlink latency is much less due to the higher bandwidth the eNodeB can provide and that FoTA updates are insignificantly infrequent, they will not be investigated in this study, although it can be in the future.

### 3.5.3 Data Overhead

Variation in data overhead can be measured using TX, and RX byte counters. Usually the heavier the IoT protocol the more overhead, but we want to see the minimum overhead and therefore UDP is chosen out of TCP, CoAP and MQTT. UDP payloads are dynamic in size, but limited to 512 bytes. The UDP header is about 48-60 bytes in length, and so an application sending 100 bytes will actually send about 160 bytes. For devices in the extreme coverage class 2, this can be quite taxing on battery life and costly in terms of airtime. UDP sockets can remain open in PSM mode, so that the UE device may later resume the RRC connection with that context, thus saving considerable signaling overhead for the setup and transmission of infrequent small data packets.

## 3.6 Estimations

Two metrics are estimated in this study, including telemetry interval and battery longevity.

### 3.6.1 Telemetry Interval

The recommended telemetry interval or periodicity can be estimated for each telemetry type, including differently-sized UDP transmissions, Echo, COPS, eDRX and PTAU. In §4.3.1, telemetry interval is estimated in hours using the mean measured and UE reported values obtained in Appendix A.3 and B.4.

### 3.6.2 Battery longevity

Similarly, the battery longevity can be estimated for each telemetry type, including differently-sized UDP transmissions, Echo, COPS, eDRX and PTAU. In §4.3.2, battery longevity is estimated in years using the mean measured and UE reported values obtained in Appendix A.4 and B.5.

## 3.7 Field Test Captures

Ublox and Quectel data has been captured for:

- Nokia networks at Vodacom head office in Century City, Cape Town
- ZTE at the MTN Mobile Intelligence Lab, Stellenbosch inside an RF enclosure with the door slightly open (to ultimately reach the edge of received signal strength).



- Ericsson at MTN headquarters on 14th Avenue, Johannesburg
- Huawei on the Vodacom network in Quellerina, Randburg, Johannesburg

### 3.7.1 Dataset

The total dataset can be better represented visually in Figures 3.37 and 3.38.

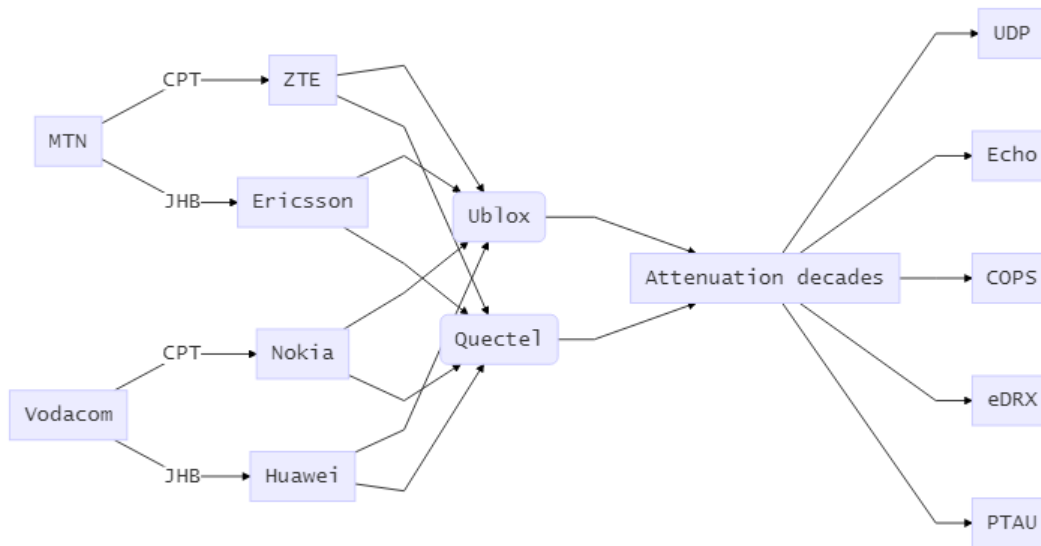


Figure 3.37: Visual representation of dataset. Five telemetry tests performed to at least five attenuation zone decades on two UE devices, four LTE vendors and two MNOs in Cape Town and Johannesburg.

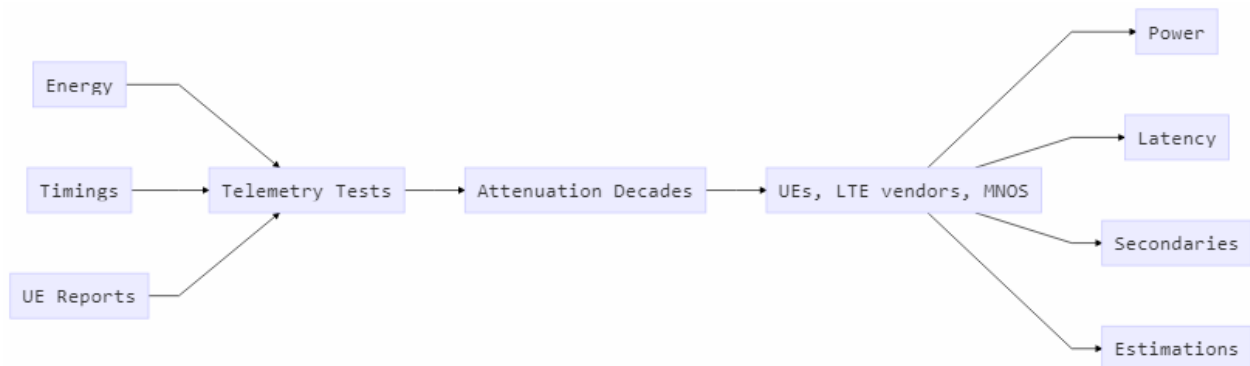


Figure 3.38: Each telemetry test takes in readings from the external energy capture device and UE reported values and through attenuation zone decades, UEs, LTE vendors and MNOs we extract power efficiency, latency, secondary metrics and estimations.

Every UE device and MNO pair (8 total) has 9 telemetry tests (of which 5 are differently-sized UDP datagrams) and each has its own attenuation zone decade (at least 5). The Cape Town dataset alone contains 424 files with 1811 trace entries, 40 possible submetrics (AT+NUESTATS, energy and timings combined in CSV files) and 79921 values. With the Johannesburg dataset included, there are 1390 CSV files in total.

The dataset is also heavily skewed towards lower latency entries in terms of a higher count. Multiple entries per test were captured, with the intent of increasing reliability, at a target of roughly 10 entries. Especially when entries takes a couple of seconds, but when an entry (unexpectedly) took up to 300 seconds it had

a much lower chance of having 10 entries captured. Also considering that future dataset capture may be repeated in different locations, one does not necessarily want to spend more than a day on-site.

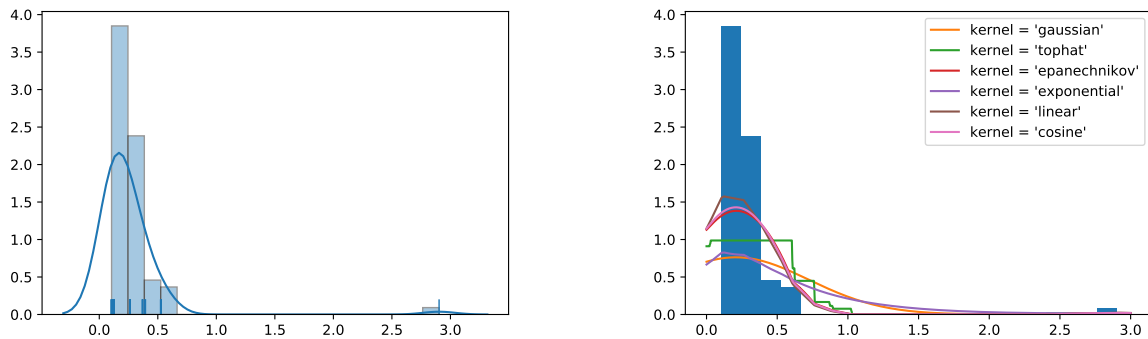
To solve for the skewness, each test can be normalized by taking a single mean of each of the associated trace entries and files. With a dataset of 140/1811 traces, it would make a minimum of 5600/79921 possible values. Unfortunately this created the problem of lost features when multiple means are concerned, such as in ECL reports. To solve this, k-means clustering is applied as in §3.7.2.2.

### 3.7.2 Post-processing

A method of post-processing the data for analysis is required for the dataset obtained in §3.7.1. Probability estimation was attempted, yet not considered as making histograms and kernel density estimations are two layers of manipulation on raw data before comparison. Instead, k-means clustering was performed on the dataset to lower low-latency skewness and any other concentrated features to achieve a more normalized result with unique features for comparison. Finally, a plotting and extraction framework was developed in Jupyter with custom libraries developed in Microsoft Visual Studio Code (`vscode`). Plots are placed throughout this thesis, with “9-plots” that visualize the dataset in Appendix C, and measured or UE reported metrics and estimations in Appendix A and B, respectively.

#### 3.7.2.1 Probability estimation

Due to the large dataset and requiring a reasonable means of analysis, probability estimation is considered.



(a) The probability of the discrete data can be estimated in a continuous probability density function (PDF) with the kernel density estimation.

(b) Various types of kernel density estimation (KDE) all attempt to predict latency outcome with varying accuracy.

Figure 3.39: Probability estimation on latency histogram sample

Good practice would be viewing the data as is and not trying to analyze it from what is essentially a modified new perspective. Considering how various methods and techniques are used to estimate probability, there will always be a degree of inaccuracy, and in future work machine learning models can be considered to predict UE device behavior. In this thesis, we offer a two-pronged approach where we would like to view the data as close as possible to its raw form, yet as simple as possible for comparison.

#### 3.7.2.2 K-Means Clustering

Instead of finding a single mean for all the entries and associated files, at least three means are specified ( $K=3$ ) to take into account the outliers that some tests produce or more for isolated regions ( $K=4+$ ).

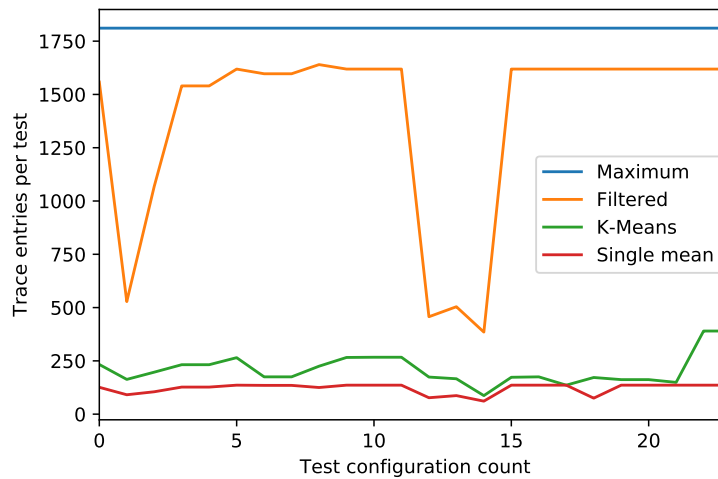


Figure 3.40: Trace entries per test (CSV file). In this example, the absolute maximum of 1811 traces has been filtered by removing duplicates and applying thresholds. K-means clustering achieves the desired effect of reducing dimensionality and skewness induced from low latency sampling on the dataset for different tests, yet keeps most of the features of the thresholded max. This allows for easier visualization and unbiased feature comparison.

### 3.7.2.3 Plot Visualization: Jupyter

Jupyter is a python framework which is used for post-processing, and the following code snippet shows an example of the 9-plot format used in the results (Chapter 4):

```
import jupyterlib as j
import plotter as p
import plotter4 as p4

import numpy as np
import matplotlib.pyplot as plt
import matplotlib.ticker as ticker

import importlib

def plot(*args, **kwargs):
    importlib.reload(j)
    importlib.reload(p)
    importlib.reload(p4)
    test1 = ['1-16 B', '64-128 B', '256-512 B', 'Echo', 'COPS', 'eDRX', 'PTAU']
    K = kwargs.pop('K') if 'K' in kwargs else None
    p4.plot(db(), *args, **kwargs, K=K if K else 3, folder='plotterk', joburg=True,
            test1=test1)

...
...

plot('SNR', 'txTime', 'SNR (dB)', 'Latency (s)', scale=[10,1000], K=5)
plot('Signal power', 'energy', 'RSRP (dBm)', 'Power (uWh)', [10,3.6], K=6, log=True)
```

As there are numerous Jupyter files, most code resides in custom libraries which can be imported into each file to maintain consistency in case of duplication errors, and this can also be found on <https://github.com/daniel-leonard-robinson/masters/tree/master/code/tests>. During development on the custom libraries, Jupyter

requires `importlib` to reload each library when a master function such as `plot(*args, **kwargs)` is called.

Table 22: Custom libraries imported by Jupyter and a description of their purpose

Library	Purpose
<code>jupyterlib</code>	processing CSV files, directories, tests, thresholds
<code>plotter</code>	gathering data into single dictionary database for plotting
<code>plotter4</code>	plotting data in 9-plot format, K-means clustering

Other plots were more specialized and code was kept within the Jupyter file it was developed in. Although the goal of plots in general is to investigate observations and comparisons, it is intended for visualisation of the results in Chapter 4. A short description is occasionally written about the plots of the datasets captured in Cape Town, with the second set of `9-plots` showing the results in Johannesburg left up to the interpretation of the reader. If plots are omitted, they show quite similar information, and duplication is not necessary.

In the top left corner of the `9-plots` exists a box which shows the number of k-means cluster filtered data points out of the total number of possible filtered points, as well as the ‘K’ value in the filtering process. Each diagram is marked from ‘A’ to ‘I’, with ‘F’ showing boxplots of Ublox and Quectel distributions on the relevant MTN and Vodacom network, depending on if the data was captured in Cape Town or Johannesburg.

- ABC shows UE device and MNO comparisons
- DE shows plots with data points by attenuation decade
- GH shows plots with data points by telemetry test set
- ADG and BEH shows two different types of LTE vendor, respectively.

## 4 RESULTS

### 4 Results

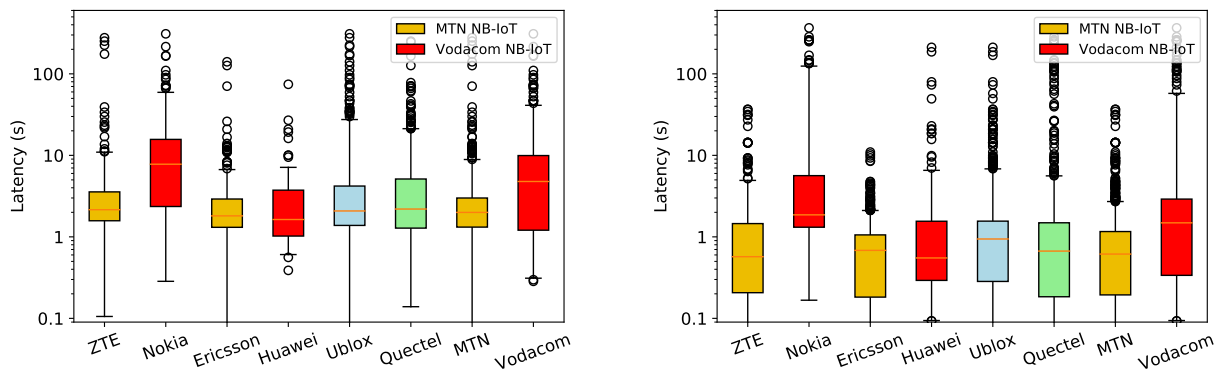
This chapter visualizes and analyzes the results from the datasets obtained in Chapter 3, with comparisons drawn against LTE vendors, UE and MNOs. Metrics are analyzed using UE reports from the modem and measurements using the external energy capture device in §3.3.1.3. The datasets are created using telemetry tests which are performed in various network conditions using RF attenuation, and in some cases an example is shown in ECL class 1 due to its higher likelihood of being used. Analysis is performed in a two-pronged approach, with the entire dataset which is visualized (format in §3.7.2.3) in Appendix C, and mean distributions in Appendix A and B.

#### 4.1 Primary Metrics

This section looks at primary metrics as mentioned in §1.2. Power efficiency and Latency are primary metrics due to the fact that they can be compared between external measurements and UE reports.

##### 4.1.1 Latency and Delay

This section presents measured and UE reported latency distributions using the telemetry test set and different attenuation zones to compare multiple LTE vendors, UE devices, and MNOs. Fig. 4.1 shows us latency values for the entire dataset, and Fig. 4.2 shows an example in ECL class 1 network conditions.

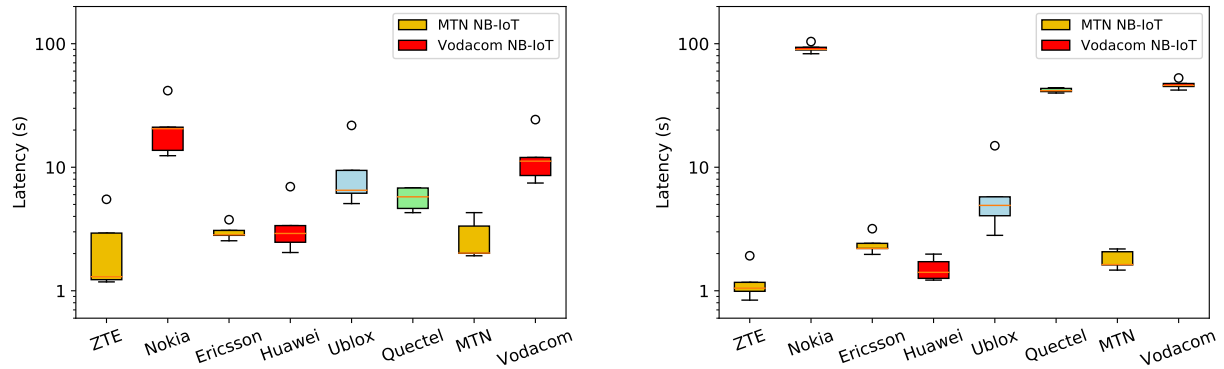


(a) The figure shows measured latency distribution with the dataset shown in Appendix C.1.1

(b) The figure shows UE reported latency distribution from transmitted and received time with the dataset shown in Appendix C.1.2 and C.1.3

Figure 4.1: Measured and UE reported latency using telemetry tests from Appendix C with outliers extending up to 300 seconds. LTE vendors exhibit satisfactory latencies under 10 seconds in 95% of cases, except for Nokia achieving the target in only 50% of measurements. Nokia's poor performance results in MTN leading Vodacom in datagram latency in both cases. Looking at the 25th percentile as a baseline, it appears that UE reported latencies are smaller than measured values by a factor up to 5. Figure 4.1a shows latencies with the 25th percentile above 1 second. ZTE, Ericsson and Huawei have a central tendency at 2 seconds, with 95% of values under 10 seconds. Nokia has a median at 8 seconds and 95th percentile at 60 seconds. Both Ublox and Quectel modems share similar distributions. Figure 4.1b shows latencies with the 25th percentile above 200 ms. ZTE, Ericsson and Huawei have a central tendency between 600 and 700 ms, with 95% or more values under 7 seconds. Nokia has a median at 2 seconds and 95th percentile over 100 seconds. The latency distribution of Quectel modems are slightly better than Ublox, but outliers extend further.

There is a large discrepancy in the datagram latency between MTN and Vodacom in both Figure 4.1 and 4.2 due to Nokia's poor performance. Although LTE vendors show satisfactory latency performance under 10 seconds, Nokia needs to be reconfigured for Vodacom. Ublox modem reports and measurements show similar characteristics to Quectel modem measurements, but the Quectel modem reports characteristics worse than expected in ECL class 1 measurements. Latency impacts energy consumption and the ability of the UE to update cloud-based applications timeously.



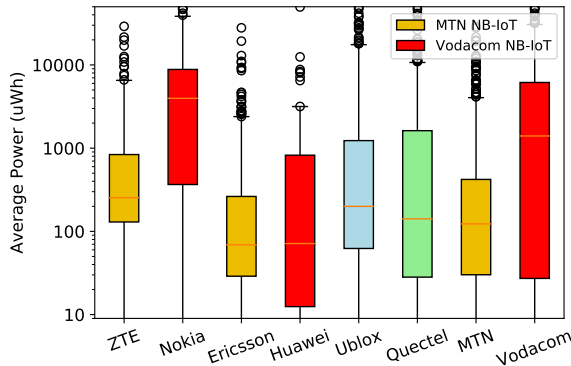
(a) The figure shows measured latency distribution with mean dataset as shown in Appendix A.1.

(b) The figure shows UE reported latency distribution with mean dataset as shown in Appendix B.1 and B.2.

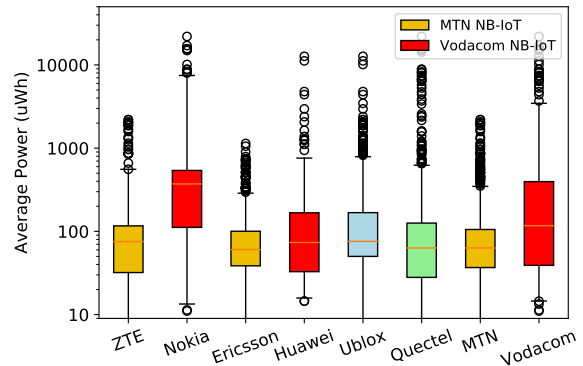
Figure 4.2: Latency in sending 16-512 byte packet payloads in ECL class 1 network conditions with a mean distribution baseline around 1 second and ranging up to 100 seconds. MTN shows a better mean latency distribution than Vodacom due to Nokia. In Figure 4.2a, Ericsson and Huawei show similar distributions with a median at 3 seconds. ZTE too shows a similar distribution, yet with a median extending to just above 1 second. On the other hand, Nokia has a median latency of 20 seconds and the entire distribution is above 10 seconds. With a median around 6 seconds, Quectel is performing slightly better than Ublox modems. In Figure 4.2b, ZTE, Ericsson and Huawei share similar mean latency distributions between 1 and 3 seconds, yet Nokia reports just under 100 seconds. Ublox is performing much better with a mean latency distribution at 5 seconds than Quectel at 40 seconds.

4.1.2 Power Efficiency

This section presents measured and estimated (using Eq. 5) average power distributions using the telemetry test set and different attenuation zones to compare multiple LTE vendors, UE devices, and MNOs. Fig. 4.3 shows us average power values for the entire dataset, and Fig. 4.4 shows an example in ECL class 1 conditions.

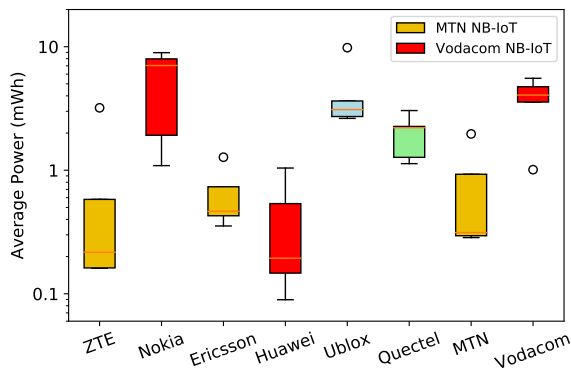


(a) The figure shows measured average power distribution with dataset as shown in Appendix C.2.1.

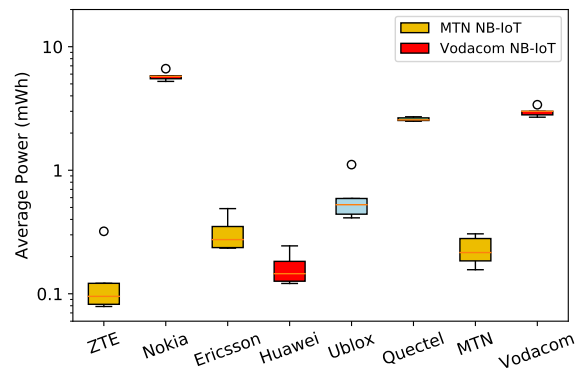


(b) The figure shows UE reported average power estimation distribution using transmit and receive time dataset as shown in Appendix C.1.2 and C.1.3.

Figure 4.3: Average power of telemetry test datagrams with a 25th percentile baseline around  $30 \mu Wh$ . LTE vendors show varying results between  $30 \mu Wh$  and  $10,000 \mu Wh$ , yet Nokia shows average power consumption worse than ZTE, Ericsson and Huawei by a factor of 20 or more. Quectel shows slightly better values than Ublox modems, and MTN remains the leader for datagram power efficiency for various telemetry tests due to Nokia’s poor performance. In Figure 4.3a, Ericsson and Huawei have central tendencies under  $100 \mu Wh$ , unlike ZTE and Nokia with 250 and  $4000 \mu Wh$  respectively. Ublox and Quectel modems share similar average power measurement distributions, with Quectel slightly better. In Figure 4.3b, ZTE, Ericsson and Huawei show similar central tendencies under  $100 \mu Wh$ , yet Nokia is at  $400 \mu Wh$  average power. Ublox and Quectel show similar reported average power distributions, with Quectel slightly better.



(a) The figure shows measured average power distribution in ECL class 1 with mean dataset as shown in Appendix A



(b) The figure shows estimated average power distribution in ECL class 1 with mean dataset as shown in Appendix B

Figure 4.4: Average power in sending 16-512 byte packet payloads in ECL class 1 network conditions. Nokia is the exception with regard to other LTE vendors by consuming energy by a factor up to 20 times more.

There is a large discrepancy in the energy consumption between MTN and Vodacom in Figure 4.3 and 4.4. Average power measurements and reports from UE modems show that Nokia is consuming more energy than ZTE, Ericsson and Nokia by a factor of 20 or more. Ublox and Quectel show similar average power distributions when considering the entire dataset, yet vary in the mean average power distributions for ECL class 1. Power consumption impacts battery longevity as in §4.3.2.

## 4.2 Secondary Metrics

This section looks at secondary metrics as mentioned in §1.2, namely signal strength (such as MCL, transmit power, RSRP, SINR and ECL classes), throughput and data overhead.

### 4.2.1 Signal Strength Metrics

It is important to know the signal strength behavior between UE devices and LTE vendors due to varying network conditions in terms of MCL, RSRP, SINR and transmit power. RSSI showed similar characteristics to RSRP, and RSRQ to SINR, and therefore omitted.

#### 4.2.1.1 Maximum Coupling Link

The RF link characteristics between the module and base station are useful in determining the range or indoor penetration the UE device can sustain.

Table 23: MCL between LTE vendor-MNO pairs and UE using process defined in §3.5.1.1.

	SINR	MCL
ZTE-MTN	-6.95 dB	165.95 dBm
Nokia-Vodacom	-7.10 dB	166.10 dBm
Ericsson-MTN	-6.10 dB	165.10 dBm
Huawei-Vodacom	-6.00 dB	165.00 dBm
Ublox	-7.10 dB	166.10 dBm
Quectel	-7.60 dB	166.60 dBm

In terms of MCL, LTE vendors and UE devices are all performing satisfactorily by meeting the 164 dBm requirement. It should be noted that SINR is a proprietary measurement.

#### 4.2.1.2 Transmit Power

Observing the results in Appendix C.3.1.2, UE devices decrease their output power at roughly 10 dBm per decade of RSRP amplification from -100 dBm onwards except for Vodacom-Nokia which maintains maximum output power.

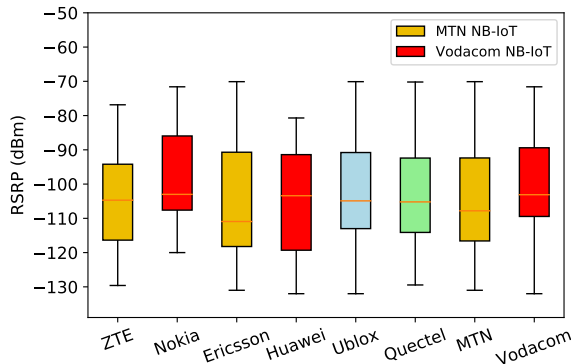
#### 4.2.1.3 RSRP and SINR

Since RSSI combines RSRP and transmit power, they are shown separately instead with RSSI omitted. Similarly, since SINR and RSRQ (which is a ratio between RSRP and RSRQ) show similar characteristics, SINR is also sufficient to show.

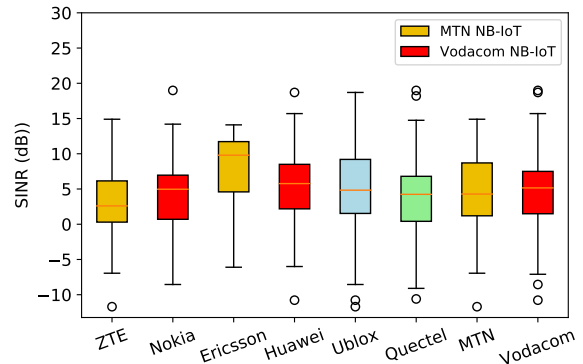
Table 24: Minimum RSRP values for LTE vendors and UE.

	Minimum RSRP
ZTE-MTN	-129.6 dBm
Nokia-Vodacom	-120.0 dBm
Ericsson-MTN	-131.0 dBm
Huawei-Vodacom	-132.0 dBm
Ublox	-132.0 dBm
Quectel	-129.4 dBm





(a) The figure shows UE reported RSRP. Although Ericsson’s RSRP extended up to -20 dBm due to laboratory conditions, it is limited to -70 dBm. LTE vendors have similar values at -130 dBm, except for Nokia at -120 dBm, with approximate minimum values shown in Table 24.

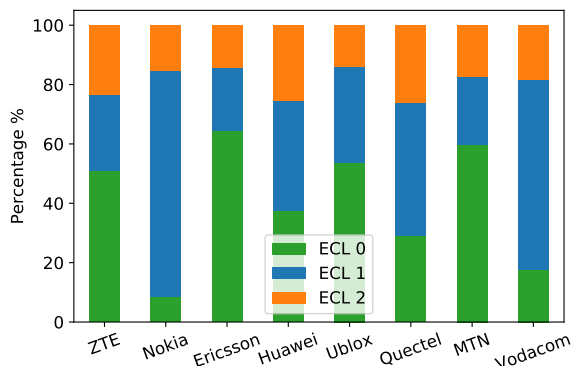


(b) With respect to LTE vendors, SINR is reported to be approximately from -7 dB to 15 dB, with approximate minimum values shown in Table 23. SINR values are more evenly distributed than RSRP, yet with more outliers.

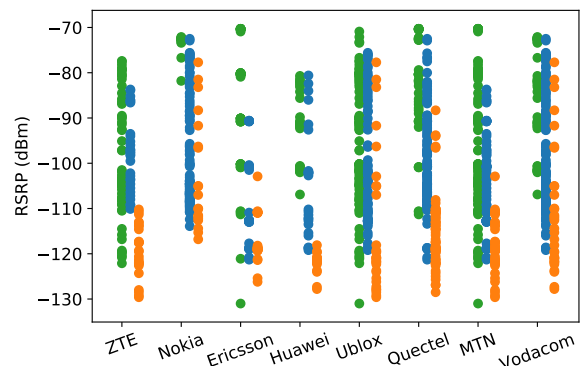
Figure 4.5: UE reported RSRP and SINR for LTE vendors, UE and MNOs. The maximum values depend on where the test took place, before signals are attenuated until disconnection. Ublox and Quectel show similar values, unlike the defined disparity stated in §3.5.1.4. MTN and Vodacom also show similar values, except for the 10 dBm deterioration in the Vodacom-Nokia RSRP. This deterioration could be as a result of NB-IoT being configured for in-band or guard-band instead of stand-alone. Overall, signal strength in terms of RSRP and SINR shows satisfactory performance, except for Vodacom-Nokia.

#### 4.2.1.4 Enhanced Coverage Levels

ECL classes (in §2.5.6 and §3.5.1.7) increase repetition depending on signal strength between UE device and eNodeB. The section looks at the percentage distribution of ECL classes in the different datasets and against RSRP. It was not considered to use SINR as it showed similar results.



(a) The figure shows the percentage distribution of ECL classes for different datasets. Notably, about 90% of Nokia’s dataset lies within ECL class 1, as opposed to roughly 50% of ZTE, Ericsson and Huawei’s distribution in ECL class 0, which means Nokia will impact battery usage more for UE devices. It can be seen that 25% of Quectel’s distribution exists in ECL class 2, with Ublox showing only half as much. This is significant because it means that Ublox devices fare better in deeper coverage situations than Quectel.



(b) The figure shows the distribution of ECL classes against RSRP. Transitions between ECL classes vary between LTE vendors depending on their network configuration and possibly another factor, as there is significant overlap between ECL class 0 and 1. ECL class 2 is more well defined, existing from roughly -110 dBm to -130 dBm, except for Nokia which shows values up to -80 dBm.

Figure 4.6: UE reported ECL in percentage distributions and against RSRP. The SINR distribution was considered as it may have been alternative factor influencing ECL, but due to similarities it is not shown henceforth. ECL classes impact energy consumption, latency and battery longevity depending on location with respect to cell towers for static devices, and it is important that networks don’t transition UE devices into higher ECL classes too early as signal strength decreases.

It is also visible in Appendix C how an RF connection will be treated as ECL class 0 until approximately -90 dBm. From thence until -110 dBm it will be in ECL class 1 and any last bit of link budget can be accessed in ECL class 2 until disconnection at most at -130 dBm. Unfortunately, due to the overlap between ECL classes, there is only a partial correlation with signal strength, and LTE vendors should work with UE manufacturers to ensure a smoother transition between classes.

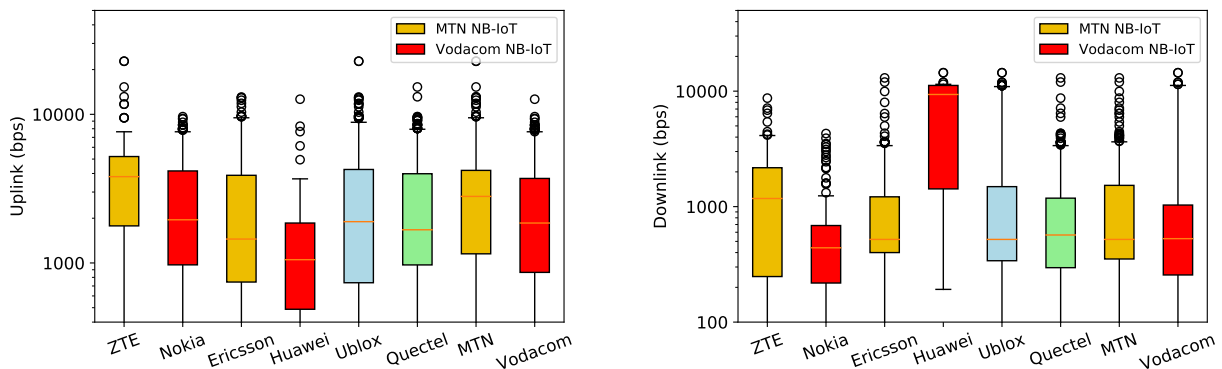
Table 25: The table shows the highest RSRP level at which ECL classes transition for LTE vendors, as well as when assuming a base RSRP of -70 dBm for a typical device, the indoor penetration is measured before ECL 2 is reached, which results in deep penetration until disconnection.

	ECL class 1	ECL class 2	Indoor Penetration	Deep Penetration
ZTE-MTN	-85 dBm	-110 dBm	40 dB	20 dB
Nokia-Vodacom	-70 dBm	-75 dBm	5 dB	45 dB
Ericsson-MTN	-90 dbm	-100 dBm	30 dB	20 dB
Huawei-Vodacom	-80 dBm	-120 dBm	50 dB	10 dB

In Table 25, ECL class transitions and signal penetration is observed. Interestingly, ECL class 1 transitions are quite high which show the overlap with ECL class 0. In indoor penetration the device will still use relatively low power until deep penetration in ECL class 2. Application developers will generally want to avoid using deep penetration unless absolutely necessary, due to the high number of repetitions and energy consumption.

### 4.2.2 Throughput

This section displays the throughput measurement for the combined RLC and MAC physical layers. These values provide an indication of the efficiency of the radio link. With bad block error rate (BLER > 10%), these values will be low. With a very good BLER (< 1%), these values will be near the theoretical throughput of NB-IoT. It is only over the protocol stack itself and does not take into account the time to wake up, scan for base stations and so forth. As stated in §2.3.3, NB-IoT has a theoretical uplink and downlink throughput of ~250kbps.



(a) The figure shows RLC and MAC uplink throughput, with 95% of values under 10 kbps. ZTE is performing best with a central tendency at 4 kbps, and Huawei the least at 1 kbps. It is shown that Nokia, Ericsson, Ublox, Quectel and Vodacom have similar central tendency distributions at 2 kbps, while MTN leads with 3 kbps.

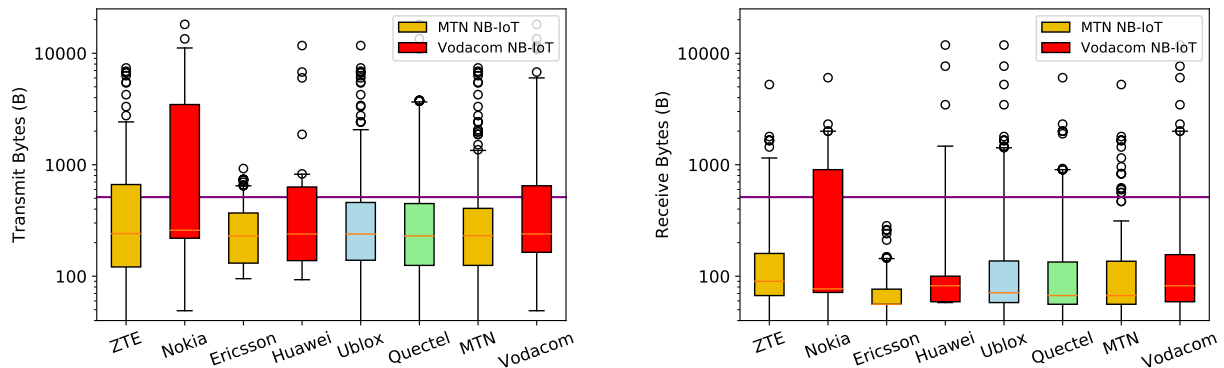
(b) The figure shows RLC and MAC downlink throughput, with 95% of values under 10 kbps, except for Huawei with 50% of values just over 10 kbps. Nokia, Ericsson, Ublox, Quectel, MTN and Vodacom all share similar distributions with a central tendency at 500 bps, and with ZTE at just over 1 kbps. Quectel and MTN have 95% of values at 3 kbps as opposed to Ublox and Vodacom at 10 kbps.

Figure 4.7: The figure shows RLC and MAC layer throughput for LTE vendors, UE and MNOs. 95% of values under 10 kbps, and although Huawei performs the least in uplink at a 1 kbps central tendency, Huawei surprisingly takes the lead in downlink throughput at just over 10 kbps. Quectel and Ublox exhibit similar characteristics and MTN leads Vodacom marginally by a difference of roughly 1 kbps.

UE reported throughput values under 10 kbps are well under the 250 kbps speeds claimed by NB-IoT manufacturers in general. However, it is more in line with the Quectel modem claiming single tone uplink and downlink of 21.25 and 15.625 kbps, respectively. On the other hand, although Ublox and Quectel show similar distributions, Ublox claims uplink and downlink of 62.5 and 27.2 kbps, respectively, which shows that Ublox is underperforming. Throughput is necessary to take into account for large data transfers such as captured data, images and FoTA updates, and with low values it would affect energy consumption and latency.

### 4.2.3 Data Overhead

This section presents transmitted and received byte counts for datagrams distributed using the telemetry test set and different attenuation zones to compare multiple LTE vendors, UE devices, and MNOs as shown in Fig. 4.8. Considering the variability in figure 3.26, taking the mean would make for a simpler representation per UDP size as in Appendix B. However, a boxplot representation shows the characteristics of the data more fully with respect to LTE vendors, UE and MNOs. Since the largest UDP packets are 512 bytes in size, a line is drawn at this value for comparison. Data overhead is observed for all telemetry tests at once.



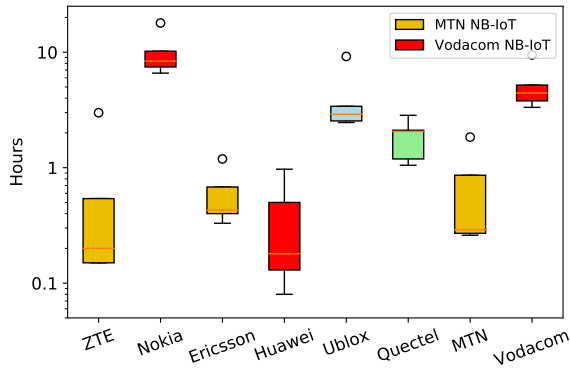
(a) Transmission bytes of all manufacturers and operators, with at least 50% of values centered between 100 and 1000 bytes except for Nokia which extends further, having a 95th percentile at 10,000 bytes or more in outliers.

(b) Receive bytes of all manufacturers and operators, with at least 50% of values centered between 50 and 200 bytes except for Nokia which extends up to a 95th percentile at 2000 bytes, or more in outliers.

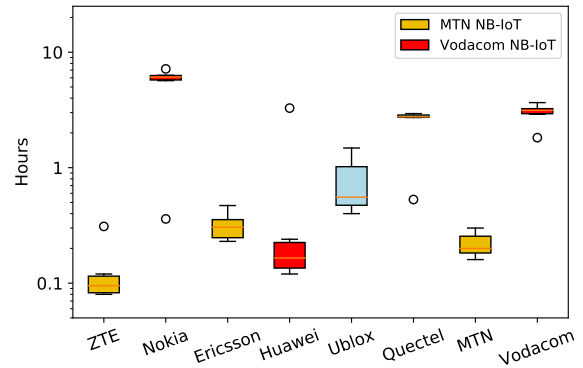
Figure 4.8: Byte size distribution of telemetry test set across different MNOs, LTE Vendors and UE devices with 512 byte limit line (purple). Ublox and Quectel show equal distribution characteristics, while MTN leads Vodacom marginally. In general, 25% of uplink datagrams extend above the specified 512 byte limit and 25% of downlink datagrams extend past 200 bytes. Nokia extends well past the 512 byte limit to a few thousand bytes in both cases due to repetition caused by the ECL mechanism.

### 4.3 Estimations

#### 4.3.1 Telemetry Interval



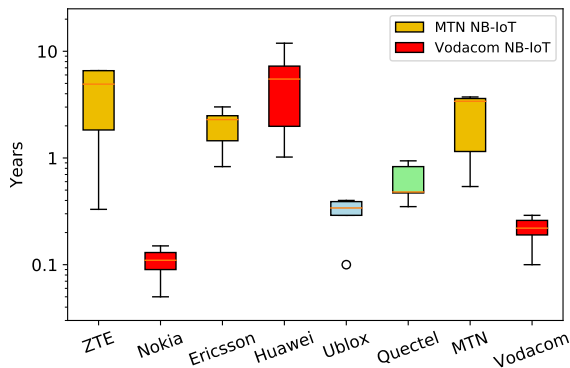
(a) The figure shows estimated telemetry interval using energy measurements from Appendix A. ZTE, Ericsson and Huawei require messages to be sent within every 5 minutes to an hour to last a year on a 9.36 Wh battery (AA-sized), while Nokia requires a telemetry interval around 10 hours. In these measured estimations, Quectel shows better values than Ublox.



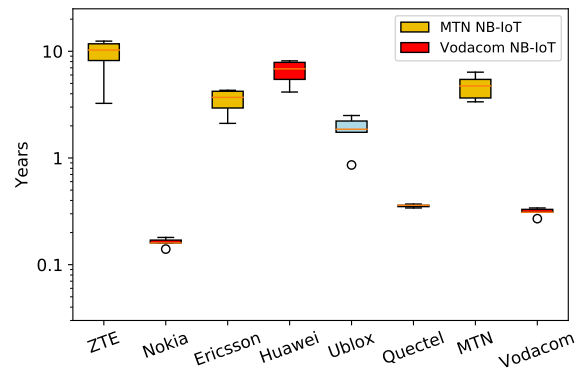
(b) The figure shows telemetry interval estimations for UE reported RF time from Appendix B. ZTE, Ericsson and Huawei require messages to be sent within every 5 to 30 minutes, while Nokia expects a telemetry interval every 6 hours. In these estimations from UE reports, the Ublox modem is shown to be better than the Quectel modem.

Figure 4.9: Telemetry interval estimation sending 16-512 byte packet payloads in ECL class 1 network conditions. Quectel is measured to be better than Ublox, yet Ublox reports better values than Quectel. MTN leads Vodacom due to Nokia’s poor performance.

#### 4.3.2 Battery longevity



(a) The figure shows battery longevity estimations using energy measurements from Appendix A up to 10 years. ZTE, Ericsson and Huawei show results distributed roughly between 1 to 10 years, while Nokia sits between 2 to 8 weeks. In these measured estimations, the Quectel modem shows better values than the Ublox modem.



(b) The figure shows UE reported RF time from Appendix B up to 10 years. ZTE, Ericsson and Huawei show results distributed roughly between 2 to 10 years, while Nokia sits at around 8 weeks. In these estimations from UE reports, the Ublox modem is shown to be better than the Quectel modem.

Figure 4.10: Battery longevity estimation sending 16-512 byte packet payloads in ECL class 1 network conditions. According to LTE vendor results, UE devices will last a couple of years up to 10, except for Nokia which will only last a few months. Measurements show Quectel is better than Ublox, yet Ublox reports better results than Quectel. MTN leads Vodacom due to Nokia’s dismal performance. Estimation results from UE reports tend to underestimate measured values, and this should be taken into account when a developer uses UE reports in their application.

## 4.4 Summary

The study investigated the following metrics and estimations using a set of telemetry tests performed on LTE vendors by UE devices: power efficiency, latency, signal strength, throughput, data overhead, telemetry interval and battery longevity with significant variation observed on all of these. Most clearly visible is how MTN leads Vodacom in results due to Nokia's poor performance. Even so, there still exists a significant degree of variation among LTE vendors which supports the notion that the complexities of network configuration itself do affect quality of service as it is mandatory for LTE vendors to meet 3GPP requirements. More than one UE device was chosen to determine if variation is further exacerbated by type of UE, namely Ublox and Quectel, although these devices return relatively similar results. This shows that the cause of variation lies most likely with the LTE vendors and how MNOs have them configured.

With regard to the main metrics in this study, power efficiency tests show that UE devices connected to Vodacom-Nokia are using up to 20 times more energy than other LTE vendors. ZTE, Ericsson, and Huawei perform satisfactorily in latency tests, with 95% of datagrams under the 10 seconds standard by 3GPP, while Nokia results in a 95th percentile at 100 seconds.

In terms of signal strength, LTE vendors and UE perform satisfactorily by meeting the 164 dBm MCL requirement, yet Vodacom-Nokia shows a minimum RSRP at -120 dBm as opposed to the others at -130 dBm. 90% of Nokia's dataset lies within ECL class 1, as opposed to roughly 50% of ZTE, Ericsson and Huawei's distribution in ECL class 0, which means Nokia will impact battery usage more for UE devices. Due to the overlap in ECL classes according to RSRP<sup>6</sup>, it suggests only a partial correlation, which means there is another unknown factor<sup>7</sup> which influences the dynamic ECL class provisioning by the network. Nevertheless, looking at the highest RSRP before an ECL class transitions, it is observed that Nokia can potentially be in ECL class 2 after 5 dB of attenuation in a typical environment of -70 dBm RSRP, while Huawei is looking at 50 dB of attenuation before requiring deep penetration in ECL class 2 until -130 dBm RSRP. In terms of transmit power, UE devices generally transmit at max 23 dBm power from -130 dBm to -100 dBm RSRP, whereby they decrease their output power by 10 dB per decade of RSRP amplification from -100 dBm RSRP upwards except for Vodacom-Nokia which maintains maximum output power.

In terms of throughput, UE devices and LTE vendors report a central uplink and downlink averaging 2 kbps and 500 bps, respectively, and extending up to 10 kbps. Surprisingly, although Huawei averages the least at 1 kbps in uplink, it averages 10 kbps in the downlink. Throughput needs to be considered for real-time applications when limited by uplink and downlink speed, and it also affects latency. In observing the data overhead in the telemetry test set, 25% of uplink datagrams extend above 512 byte limit and 25% of downlink datagrams extend past 200 bytes. Nokia is shown to be the exception, extending well past a few thousand bytes in both transmission and receive bytes. This has a significant effect on airtime data cost.

The telemetry interval estimate, which indicates the periodicity of telemetry messages to last a year on a 9.36 Wh AA battery, shows that ZTE, Ericsson and Huawei can have UE devices transmit a 16-512 byte message every 5 to 60 minutes. Nokia, on the other hand, requires devices to send a message every 10 hours. Finally, battery longevity estimates which indicate how long a UE device can survive transmitting 16-512 bytes hourly, show that devices connected to a network via ZTE, Ericsson and Huawei can last up to 10 years on a 9.36 Wh AA battery, however, devices on Vodacom-Nokia will only last 2-8 weeks.

---

<sup>6</sup>SINR showed similar values to RSRP.

<sup>7</sup>The test captures did show a degree of hysteresis (a few seconds) in RSRP values when changing attenuations, and this could potentially be a factor.

## 5 Conclusion and Recommendations

This empirical study investigated NB-IoT through metrics and estimations by comparing datasets of telemetry tests performed on long-term-evolution (LTE) vendors, using user-equipment (UE) devices, for mobile-network-operators (MNOs) in South Africa. Research shows that most literature on NB-IoT is based on precise mathematical models, analysis or simulations. Thus, this study furthers the empirical performance evaluation by Martinez and Durand [2],[1] showing variability in a single network, by proposing an investigation comparing multiple LTE vendors including ZTE and Ericsson on MTN's network, Nokia and Huawei on Vodacom's network and similar UE devices, Ublox and Quectel, are to be used as a control to observe network changes via RF attenuation. The study theorizes that networks are responsible for the variation found in metrics and estimations, due to the high underlying complexity of LTE architecture on which NB-IoT is based. Metrics include power efficiency, latency, signal strength, throughput, data overhead and estimations include telemetry interval and battery longevity. Datasets were created by using UE devices and an external energy capture device (in §3.3.1.3) on different LTE vendors to capture the data using a PyTest framework (in §3.7.2.3) and Jupyter for post-processing (in §??). K-means clustering (in §3.7.2.2) is used to normalize the skewness induced by low-latency captures to unique features for comparison.

Most clearly visible in the tests is how MTN leads Vodacom in results due to Nokia's subpar performance. Power efficiency and latency shows that when connected to Vodacom-Nokia, results can factor up 20 and 10 times worse, respectively. Otherwise, ZTE, Ericsson and Huawei show satisfactory latency under the 10 second 3GPP standard. Although LTE vendors meet the 164 dBm MCL requirement, Vodacom-Nokia has 10 dB less receive sensitivity, with the rest at -130 dBm. Transmit power increases at 10 dBm per RSRP decade until its maximum at 23 dBm, except for Nokia which remains at full power. ECL classes overlap with respect to RSRP, yet partially correlate, which suggests an unknown network factor or hysteresis in the test captures. Nevertheless, Nokia is mostly in ECL class 1, while others are a mix of ECL class 0 and 1. This has an impact on the number of dynamic repetitions of messages between UE devices and cell-tower eNodeBs. Throughput is under 10 kbps, which is half or less than UE device claims by manufacturers. A quarter of datagrams in the telemetry test set show protocol overhead by extending over 512 bytes in uplink and 200 bytes in downlink, except for Nokia extending up to 10,000 bytes. Telemetry interval and battery longevity estimates on a 9.36 Wh AA battery suggest that ZTE, Ericsson and Huawei can transmit 16-512 bytes every 5 to 30 minutes to last a year, or hourly to last up to 10 years, however, a device that transmits hourly on the Vodacom-Nokia network will only last 2 months.

With these results in mind, it is visible how NB-IoT can certainly be a competitor to other LPWANs such as SigFox and LoRaWAN, and definitely better than GPRS which requires constant paging or signaling. It also has bidirectionality, which minimizes human interaction and making it even more suitable for IoT than the aforementioned unidirectional LPWANs. Unfortunately the variation induced by network changes, such as from deeper coverage and penetration requirements, are a cause for concern. It is suggested that LTE vendors and UE device manufacturers work together to create an optimum solution, considering that much of the equipment is not open to the public. Nevertheless application developers can already optimize their configuration and operation. Although maximum transmit power can dissuade developers, since it is active only part of the time the datagram sequence executes, it is really latency, and hence the number of repetitions (128 in downlink, 2048 in uplink) in higher ECL classes that affect power consumption. To avoid this, although NB-IoT has decent urban range (over 5km in §3.1.2), make sure to set up in an area with good coverage in ECL class 0 or 1. Unfortunately, throughput does not extend past 10 kbps, but there are better devices on the market. In dealing with data overhead, it is better to lump multiple measurements into a larger 512 byte packet than sending multiple smaller packets as in the 12 bytes suggested for SigFox and LoRaWAN (SF12). This is also useful, as packet size does not have as much of an effect on power consumption (in §3.4.1) as the aforementioned latency. The telemetry interval estimate, which indicates the periodicity of telemetry messages to last a year on an AA battery, can be used to extend battery life prediction depending on the use case. A strong and overlooked use case is a push/pull model which incorporates edge computing (in §2.2.2.1). By pushing data only when complex queries arrive, much battery life is saved due to downlink energy being much less than uplink. This is furthered aided by the configurable eDRX interval which allows UE devices to be paged by the network serving cell(s) it is registered to. In essence, it is much easier to listen to an application server periodically for when data should be pulled than to periodically just push data as in unidirectional networks, and better yet when the server can make dynamic complex queries to process

## 5 CONCLUSION AND RECOMMENDATIONS

---

the data. Of course, although the PTAU timer is useful for “checking in” by updating tracking area codes and IDs for UE devices and networks, its interval can be minimized especially in static cases. NB-IoT can certainly be applied to various use cases due to its bidirectionality and actuator control (in §2.4.2). Although intra-cellular frequency reselection works, it is suggested to wait for 3GPP Release 14 which adds ‘proper’ mobility (or inter-cellular frequency reselection), broadcast ability and terrestrial tracking using OTDOA before transitioning to applications which require movement.

When the immutable inactivity timer (in §2.5.4) is running after COPS network registration or reception of a datagram in eDRX mode (as in §3.3.4.5), which can last anywhere from 20 seconds (default) to a couple of minutes, termination is necessary using release assistance (in §??). This can be performed by sending a near-empty UDP packet with the release indicator flag set to 0x200. The inactivity timers in South Africa have unusually low C-DRX settings as in §3.1.1.4, and therefore mobile network operators should work to increase this to at least 2.048s as used by Vodafone in Barcelona[2] for better energy consumption. It should be mentioned that the addition of another AA battery can double battery lifetime, and adding forms of energy harvesting can possibly make its lifetime indefinite.

Considering the 180 kHz wide narrowband physical uplink shared channel (NPUSCH) in §?? and the anomaly in Appendix F, care should be taken not to attempt transmitting all at once when scaling up to multiple devices in the field, even though the protocol has its own version of listen-before-talk (LBT). Transmitting hourly it should be possible to have over 50,000 UE devices on a single eNodeB. With all the development kits and resources available, it should be quite simple for application developers to develop their own project (as in §??).

South Africa is ready for mobile network operators to deploy national NB-IoT coverage using ZTE, Ericsson and Huawei, but not Nokia. With a satisfactory inter-cell tower distance, UE devices avoid having to use dynamic repetitions in higher ECL classes, thus keeping the variation that affects many of the metrics and estimates in the study to a minimum.

## 5 CONCLUSION AND RECOMMENDATIONS

## References

- [1] T. Durand, L. Visagie, and M. Booyesen, "Evaluation of next-generation low-power communication technology in IoT-applications," *IET Communications*, pp. 1–8, 2019.
- [2] B. Martinez, S. Member, F. Adelantado, A. Bartoli, and X. Vilajosana, "Exploring the Performance Boundaries of NB-IoT."
- [3] U. Enable, M. More, and I. Devices, "NB-IoT Commercialisation Case Study How China Mobile , China Telecom and China."
- [4] P. Andres-Maldonado, P. Ameigeiras, J. Prados-Garzon, J. Navarro-Ortiz, and J. M. Lopez-Soler, "Narrowband IoT Data Transmission Procedures for Massive Machine-Type Communications," *IEEE Network*, vol. 31, no. 6, pp. 8–15, 2017.
- [5] L. Feltrin, G. Tsoukaneri, M. Condoluci, C. Buratti, T. Mahmoodi, M. Dohler, and R. Verdone, "Narrowband IoT: A survey on downlink and uplink perspectives," *IEEE Wireless Communications*, vol. 26, no. 1, pp. 78–86, 2019.
- [6] P. Andres-Maldonado, P. Ameigeiras, J. Prados-Garzon, J. J. Ramos-Munoz, J. Navarro-Ortiz, and J. M. Lopez-Soler, "Analytic analysis of narrowband IoT coverage enhancement approaches," *2018 Global Internet of Things Summit, GIoTS 2018*, 2018.
- [7] A. Adhikary, X. Lin, Y. P. Eric Wang, Y. .. E. Wang, and Y. P. Eric Wang, "Performance evaluation of NB-IoT coverage," in *IEEE vehicular technology conference*, 2017, pp. 1–5.
- [8] C. Y. Yeoh, A. bin Man, Q. M. Ashraf, A. K. Samingan, A. Bin Man, Q. M. Ashraf, A. K. Samingan, A. bin Man, Q. M. Ashraf, A. K. Samingan, A. Bin Man, Q. M. Ashraf, and A. K. Samingan, "Experimental assessment of battery lifetime for commercial off-the-shelf NB-IoT module," in *2018 20th international conference on advanced communication technology (icact)*, 2018, vols. 2018-Febru, p. 1.
- [9] M. Lauridsen, R. Krigslund, M. Rohr, and G. Madueno, "An Empirical NB-IoT Power Consumption Model for Battery Lifetime Estimation," *IEEE Vehicular Technology Conference*, vols. 2018-June, pp. 1–5, 2018.
- [10] L. Feltrin, M. Condoluci, T. Mahmoodi, M. Dohler, R. Verdone, Luca Feltrin, Massimo Condoluci, Toktam Mahmoodi, Mischa Dohler, and Roberto Verdone, "NB-IoT: Performance Estimation and Optimal Configuration," in *European wireless 2018; 24th european wireless conference*, 2018, pp. 1–6.
- [11] M. El Soussi, P. Zand, F. Pasveer, G. Dolmans, M. E. Soussi, P. Zand, F. Pasveer, and G. Dolmans, "Evaluating the Performance of eMTC and NB-IoT for Smart City Applications," in *2018 ieee international conference on communications (icc)*, 2018, vols. 2018-May, pp. 1–7.
- [12] Y. D. Beyene, R. Jantti, K. Ruttik, and S. Iraj, "On the Performance of Narrow-Band Internet of Things (NB-IoT)," in *2017 ieee wireless communications and networking conference (wcnc)*, 2017, pp. 1–6.
- [13] H. Hejazi, H. Rajab, T. Cinkler, and L. Lengyel, "Survey of platforms for massive IoT," in *2018 ieee international conference on future iot technologies (future iot)*, 2018, vols. 2018-Janua, pp. 1–8.
- [14] W. Ayoub, M. Mroue, F. Nouvel, A. E. Samhat, J. C. Prevotet, and J. Prévotet, "Towards IP over LPWANs technologies: LoRaWAN, DASH7, NB-IoT," in *2018 sixth international conference on digital information, networking, and wireless communications (dinwc)*, 2018, pp. 43–47.
- [15] A. Ali, W. Hamouda, and M. Uysal, "Next generation M2M cellular networks: Challenges and practical considerations," *IEEE Communications Magazine*, vol. 53, no. 9, pp. 18–24, 2015.
- [16] K. Mekki, E. Bajic, F. Chaxel, and F. Meyer, "Overview of Cellular LPWAN Technologies for IoT Deployment: Sigfox, LoRaWAN, and NB-IoT," in *2018 ieee international conference on pervasive computing and communications workshops (percom workshops)*, 2018, pp. 197–202.
- [17] Y. C. P. Chang, S. Chen, T. J. Wang, and Y. Lee, "Fog Computing Node System Software Architecture and Potential Applications for NB-IoT Industry," *Proceedings - 2016 International Computer Symposium, ICS 2016*, no. Iii, pp. 727–730, 2017.



## 5 CONCLUSION AND RECOMMENDATIONS

- [18] Z. Qu, G. Zhang, H. Cao, and J. Xie, "LEO Satellite Constellation for Internet of Things," *IEEE Access*, vol. 5, pp. 18391–18401, 2017.
- [19] J. Bergman, M. Sundberg, Y.-P. E. Wang, O. Liberg, and J. Sachs, "EC-GSM-IoT," in *Cellular internet of things*, 2017.
- [20] Ingenu, "HOW RPMA WORKS: The Making of RPMA," *Www.ingenu.com*, 2016.
- [21] Weightless.org, "What is Weightless - Weightless." 2015.
- [22] U. Raza, P. Kulkarni, and M. Sooriyabandara, "Low Power Wide Area Networks: An Overview," *IEEE Communications Surveys & Tutorials*, vol. 19, no. 2, pp. 855–873, 2017.
- [23] A. Ikpehai, B. Adebisi, S. Member, K. M. Rabie, K. Anoh, R. E. Ande, G. S. Member, M. Hammoudeh, H. Gacanin, S. Member, and U. M. Mbanaso, "Low-Power Wide Area Network Technologies for Internet-of-Things: A Comparative Review," vol. PP. IEEE, p. 1, 2018.
- [24] F. Adelantado, X. Vilajosana, P. Tuset-Peiro, B. Martinez, J. Melia-Segui, and T. Watteyne, "Understanding the Limits of LoRaWAN," *IEEE Communications Magazine*, 2017.
- [25] SigFox, "Sigfox Technology Overview." 2016.
- [26] Y. P. .. E. P. .. E. Wang, X. Lin, A. Adhikary, A. Grövlén, Y. Sui, Y. Blankenship, J. Bergman, H. S. Razaghi, A. Grovlen, Y. Sui, Y. Blankenship, J. Bergman, and H. S. Razaghi, "A Primer on 3GPP Narrowband Internet of Things," *IEEE Communications Magazine*, vol. 55, no. 3, pp. 117–123, 2017.
- [27] J. P. N. Date, "Introduction to DASH7 Technologies," pp. 1–22, 2009.
- [28] M. Weyn, G. Ergeerts, R. Berkvens, B. Wojciechowski, and Y. Tabakov, *DASH7 Alliance Protocol 1.0: Low-Power, Mid-Range Sensor and Actuator Communication*. 2015, pp. 54–59.
- [29] J. Finnegan and S. Brown, "A Comparative Survey of LPWA Networking."
- [30] M. Lauridsen, H. Nguyen, B. Vejlgaard, I. Z. Kovacs, P. Mogensen, and M. Sorensen, "Coverage Comparison of GPRS, NB-IoT, LoRa, and SigFox in a 7800 km Area," *IEEE Vehicular Technology Conference*, vols. 2017-June, pp. 2–6, 2017.
- [31] X. Lin, J. Bergman, F. Gunnarsson, O. Liberg, S. M. Razavi, H. S. Razaghi, H. Rydn, and Y. Sui, "Positioning for the Internet of Things: A 3GPP Perspective," *IEEE Communications Magazine*, vol. 55, no. 12, pp. 179–185, 2017.
- [32] Y. Miao, W. Li, D. Tian, M. S. Hossain, and M. F. Alhamid, "Narrowband Internet of Things: Simulation and Modeling," *IEEE Internet of Things Journal*, vol. 5, no. 4, pp. 2304–2314, 2018.
- [33] B. M. Allan, J. P. Y. Arnould, J. K. Martin, and E. G. Ritchie, "A cost-effective and informative method of GPS tracking wildlife," *Wildlife Research*, 2013.
- [34] N. Bulusu, J. Heidemann, and D. Estrin, "GPS-less low-cost outdoor localization for very small devices," *IEEE Personal Communications*, 2000.
- [35] A. Bujari, B. Licar, and C. E. Palazzi, "Movement pattern recognition through smartphone's accelerometer," in *2012 IEEE Consumer Communications and Networking Conference, CCNC'2012*, 2012.
- [36] P. Goyal, V. J. Ribeiro, H. Saran, and A. Kumar, "Strap-down Pedestrian Dead-Reckoning system," in *2011 International Conference on Indoor Positioning and Indoor Navigation, IPIN 2011*, 2011.
- [37] M. Ibrahim and M. Youssef, "CellSense: An accurate energy-efficient GSM positioning system," *IEEE Transactions on Vehicular Technology*, 2012.
- [38] T. Haddrell and A. R. Pratt, "Understanding The Indoor GPS Signal," *Proceedings of the 14th International Technical Meeting of the Satellite Division of The Institute of Navigation ION GPS 2001*, 2001.
- [39] J. S. Lee, Y. W. Su, and C. C. Shen, "A comparative study of wireless protocols: Bluetooth, UWB, ZigBee, and Wi-Fi," in *IECON proceedings (industrial electronics conference)*, 2007.
- [40] Ericsson AB, "Cellular networks for Massive IoT," *White Paper*, no. January, p. 13, 2016.

## 5 CONCLUSION AND RECOMMENDATIONS

---

- [41] “CAT-M1 vs NB-IoT – examining the real differences - IoT Now - How to run an IoT enabled business.”.
- [42] A. Note, “NB-IoT Application Development Guide.”
- [43] N. Mangalvedhe, R. Ratasuk, and A. Ghosh, “NB-IoT deployment study for low power wide area cellular IoT,” in *2016 IEEE 27th Annual International Symposium on Personal, Indoor, and Mobile Radio Communications (PIMRC)*, 2016, pp. 1–6.
- [44] R. & Schwarz, “Narrowband Internet of Things Whitepaper,” p. 42, 2016.
- [45] Yocto, “Yocto Project – It’s not an embedded Linux distribution – it creates a custom one for you.”.
- [46] “LTE RSRQ to SINR - CableFree.”.

## Appendices

### A Measured Metric and Estimation Tables

#### A.1 Latency

Table 26: The table shows the mean latency measurements

	16 B	64 B	128 B	256 B	512 B	Echo	COPS	eDRX	PTAU
Ublox-ZTE	15.5	3.54	3.60	15.3	4.97	5.04	23.3	0.39	1.87
Quectel-ZTE	2.77	2.70	2.85	3.18	3.56	2.20	3.26	0.58	18.1
Ublox-Nokia	21.0	15.4	32.8	72.6	13.5	26.9	97.5	5.89	13.1
Quectel-Nokia	19.0	8.84	9.22	10.6	14.0	13.3	1.88	3.67	9.38
Ublox-Ericsson	2.21	2.18	2.25	2.61	2.89	27.6	8.15	0.35	1.85
Quectel-Ericsson	2.56	2.14	2.20	2.14	2.46	6.85	3.93	0.39	1.64
Ublox-Huawei	2.62	2.04	2.14	2.22	2.49	9.08	6.22	0.76	6.01
Quectel-Huawei	30.9	6.58	12.8	16.9	10.4	11.2	7.70	0.52	11.2
ZTE	9.15	3.12	3.23	9.27	4.26	3.62	13.2	0.49	10.0
Nokia	20.0	12.1	21.0	41.6	13.8	20.1	49.7	4.78	11.2
Ericsson	2.39	2.16	2.22	2.37	2.67	17.2	6.04	0.37	1.74
Huawei	16.7	4.31	7.49	9.57	6.46	10.1	6.96	0.64	8.61
<i>Ublox</i>	10.3	5.80	10.2	23.2	5.98	17.1	33.8	1.85	5.72
<i>Quectel</i>	13.8	5.06	6.78	8.23	7.62	8.40	4.19	1.29	10.1
MTN	5.77	2.64	2.72	5.82	3.47	10.4	9.66	0.43	5.89
Vodacom	18.4	8.23	14.2	25.6	10.1	15.1	28.3	2.71	9.94
<b>ECL class 0</b>									
ZTE	8.97	1.77	2.81	9.52	2.40	2.52	11.6	0.19	43.4
Nokia		1.17	2.75	1.38		19.8		33.1	3.39
Ericsson	2.03	1.76	1.82	1.90	1.89	3.20	5.89	0.35	1.36
Huawei	0.71	0.51	0.55	0.51	0.80	13.4	4.38	0.21	2.05
<i>Ublox</i>	4.68	1.58	1.62	4.68	1.60	9.51	8.98	0.18	1.96
<i>Quectel</i>	1.17	1.02	2.34	1.98	0.94	9.99	1.98	16.7	23.1
MTN	5.50	1.76	2.31	5.71	2.14	2.86	8.77	0.27	22.4
Vodacom	0.35	0.84	1.65	0.95	0.40	16.6	2.19	16.7	2.72
<b>ECL class 1</b>									
ZTE	1.18	1.30	1.23	5.50	2.93	1.21	2.02	0.12	1.45
Nokia	20.5	12.4	21.1	41.7	13.7	19.3	26.0	0.42	9.71
Ericsson	2.84	2.54	2.81	3.08	3.76	19.0	2.26	0.27	2.25
Huawei	2.04	2.47	2.91	6.96	3.37	2.72	8.59	0.60	2.03
<i>Ublox</i>	6.51	5.08	9.43	21.8	6.16	14.4	14.8	0.27	3.78
<i>Quectel</i>	6.79	4.29	4.64	6.82	5.76	6.71	4.63	0.44	3.94
MTN	2.01	1.92	2.02	4.29	3.34	10.1	2.14	0.20	1.85
Vodacom	11.2	7.45	12.0	24.3	8.57	11.0	17.3	0.51	5.87
<b>ECL class 2</b>									
ZTE	1.67	1.42	1.76	2.14	13.6	0.93	1.23	0.48	3.44
Nokia	3.88		4.66	8.49	7.42	23.5	55.4	3.32	45.0
Ericsson	1.73	1.67	1.58	1.58	2.18	15.4			1.31
Huawei	31.6	7.59	10.5	12.7	10.1	25.5	10.5	0.76	19.4
<i>Ublox</i>	1.00	1.06	1.03	1.12	6.50	25.3	30.0	1.51	25.9
<i>Quectel</i>	18.4	4.27	8.25	11.3	10.2	7.32	3.61	0.77	8.61
MTN	1.70	1.54	1.67	1.86	7.93	8.17	0.61	0.24	2.38
Vodacom	17.7	3.79	7.61	10.6	8.79	24.5	33.0	2.04	32.2

## A.2 Average Power

Table 27: The table shows the mean average power measurements ( $\mu Wh$ )

	16 B	64 B	128 B	256 B	512 B	Echo	COPS	eDRX	PTAU
Ublox-ZTE	8306.7	1409.9	828.29	12242.	1309.3	2719.9	11596.	41.817	298.77
Quectel-ZTE	739.98	500.84	554.34	897.32	1128.5	779.02	1816.9	52.334	13778.
Ublox-Nokia	13718.	10161.	11472.	31622.	6955.6	21088.	47927.	3778.2	11189.
Quectel-Nokia	7590.8	3618.9	4420.9	6020.0	10139.	6467.9	515.02	2083.1	5664.0
Ublox-Ericsson	273.28	234.07	291.53	453.77	730.29	9864.6	3133.5	61.501	167.12
Quectel-Ericsson	205.01	149.33	178.99	143.03	345.02	2377.7	348.18	91.928	63.772
Ublox-Huawei	504.79	375.92	424.11	396.78	404.39	4635.4	3107.1	3.7946	2005.7
Quectel-Huawei	17197.	1308.5	5684.3	3126.9	2849.1	6123.5	2292.9	0.8597	7937.3
ZTE	4523.3	955.41	691.31	6569.8	1218.9	1749.4	6706.8	47.075	7038.4
Nokia	10654.	6890.4	7946.6	18821.	8547.5	13778.	24221.	2930.6	8426.8
Ericsson	239.14	191.70	235.26	298.40	537.66	6121.1	1740.8	76.715	115.45
Huawei	8851.3	842.24	3054.2	1761.8	1626.7	5379.4	2700.0	2.3272	4971.5
<i>Ublox</i>	5700.7	3045.4	3254.0	11178.	2349.9	9577.0	16441.	971.34	3415.3
<i>Quectel</i>	6433.4	1394.4	2709.6	2546.8	3615.5	3937.0	1243.2	557.06	6860.8
MTN	2381.2	573.55	463.29	3434.1	878.30	3935.3	4223.8	61.895	3576.9
Vodacom	9752.9	3866.3	5500.4	10291.	5087.1	9578.8	13460.	1466.5	6699.2
<b>ECL class 0</b>									
ZTE	4321	704.	484.	6634	434.	1359	5798	20.9	3543
Nokia		93.6	680.	153.		2118		1164	1110
Ericsson	83.3	64.6	75.9	85.0	93.3	794.	1659	100.	40.4
Huawei	14.4	6.31	5.33	69.0	36.0	3967	536.	0.07	82.0
<i>Ublox</i>	2109	377.	235.	3185	217.	9054	3892	25.8	191.
<i>Quectel</i>	100.	57.4	387.	285.	64.9	4600	104.	5856	1814
MTN	2202	384.	280.	3359	264.	1077	3728	60.7	1773
Vodacom	7.20	50.0	342.	111.	18.0	1257	268.	5821	596.
<b>ECL class 1</b>									
ZTE	162.	217.	161.	3201	581.	305.	1254	0.95	228.
Nokia	1090	7046	7968	1919	8949	1199	2395	23.7	6469
Ericsson	428.	354.	465.	735.	1275	7568	337.	2.03	253.
Huawei	194.	89.5	147.	1042	537.	439.	4051	1.77	83.0
<i>Ublox</i>	3637	2722	3099	9823	2629	7404	1342	3.37	1898
<i>Quectel</i>	2209	1131	1272	2263	3042	2750	1375	10.9	1618
MTN	295.	285.	313.	1968	928.	3937	796.	1.49	240.
Vodacom	5551	3567	4057	1011	4743	6217	1400	12.7	3276
<b>ECL class 2</b>									
ZTE	678.	300.	461.	878.	7359	521.	562.	51.3	2073
Nokia	2022		3527	1753	648.	1583	2017	168.	5076
Ericsson	311.	238.	276.	223.	620.	6184			98.4
Huawei	1337	2117	4817	2832	2661	1618	7596	5.60	1278
<i>Ublox</i>	279.	318.	305.	280.	3370	1459	1228	12.3	2684
<i>Quectel</i>	7912	1009	4235	2563	2275	4766	1880	100.	6021
MTN	494.	269.	368.	550.	3990	3353	281.	25.6	1085
Vodacom	7697	1058	4172	2293	1655	1601	1388	87.2	3177

### A.3 Telemetry Interval

Table 28: The table shows the mean telemetry interval estimate (hours) using measured energy values for 9.36Wh AA battery (Lithium Thionyl Chloride) to last 1 year.

	16 B	64 B	128 B	256 B	512 B	Echo	COPS	eDRX	PTAU
Ublox-ZTE	7.7742	1.3195	0.7751	11.457	1.2197	2.5455	10.853	0.0391	0.2796
Quectel-ZTE	0.6925	0.4687	0.5188	0.8398	1.0562	0.7290	1.7004	0.0489	12.894
Ublox-Nokia	12.838	9.5105	10.736	29.595	6.5097	19.736	44.855	3.5361	10.472
Quectel-Nokia	7.1042	3.3869	4.1375	5.6341	9.4894	6.0533	0.4820	1.9495	5.3010
Ublox-Ericsson	0.2557	0.2190	0.2728	0.4246	0.6834	9.2322	2.9327	0.0575	0.1564
Quectel-Ericsson	0.1918	0.1397	0.1675	0.1338	0.3229	2.2253	0.3258	0.0860	0.0596
Ublox-Huawei	0.4724	0.3518	0.3969	0.3713	0.3784	4.3382	2.9079	0.0035	1.8771
Quectel-Huawei	16.095	1.2246	5.3199	2.9265	2.6665	5.7310	2.1459	0.0008	7.4285
ZTE	4.2334	0.8941	0.6470	6.1486	1.1379	1.6373	6.2769	0.0440	6.5872
Nokia	9.9715	6.4487	7.4372	17.614	7.9995	12.894	22.668	2.7428	7.8866
Ericsson	0.2238	0.1794	0.2201	0.2792	0.5031	5.7287	1.6292	0.0717	0.1080
Huawei	8.2839	0.7882	2.8584	1.6489	1.5225	5.0346	2.5269	0.0021	4.6528
<i>Ublox</i>	5.3353	2.8502	3.0454	10.462	2.1978	8.9631	15.387	0.9090	3.1963
<i>Quectel</i>	6.0210	1.3050	2.5359	2.3835	3.3837	3.6846	1.1635	0.5213	6.4210
MTN	2.2286	0.5367	0.4335	3.2139	0.8205	3.6830	3.9531	0.0579	3.3476
Vodacom	9.1277	3.6184	5.1478	9.6317	4.7610	8.9647	12.597	1.3725	6.2697
<b>ECL class 0</b>									
ZTE	4.04	0.65	0.45	6.20	0.40	1.27	5.42	0.01	33.1
Nokia		0.08	0.63	0.14		19.8		10.8	1.03
Ericsson	0.07	0.06	0.07	0.07	0.08	0.74	1.55	0.09	0.03
Huawei	0.01			0.06	0.03	3.71	0.50	6.70	0.07
<i>Ublox</i>	1.97	0.35	0.22	2.98	0.20	8.47	3.64	0.02	0.17
<i>Quectel</i>	0.09	0.05	0.36	0.26	0.06	4.30	0.09	5.48	16.9
MTN	2.06	0.36	0.26	3.14	0.24	1.00	3.48	0.05	16.6
Vodacom		0.04	0.32	0.10	0.01	11.7	0.25	5.44	0.55
<b>ECL class 1</b>									
ZTE	0.15	0.20	0.15	2.99	0.54	0.28	1.17		0.21
Nokia	10.2	6.59	7.45	17.9	8.37	11.2	22.4	0.02	6.05
Ericsson	0.40	0.33	0.43	0.68	1.19	7.08	0.31		0.23
Huawei	0.18	0.08	0.13	0.97	0.50	0.41	3.79		0.07
<i>Ublox</i>	3.40	2.54	2.90	9.19	2.46	6.92	12.5		1.77
<i>Quectel</i>	2.06	1.05	1.19	2.11	2.84	2.57	1.28	0.01	1.51
MTN	0.27	0.26	0.29	1.84	0.86	3.68	0.74		0.22
Vodacom	5.19	3.33	3.79	9.47	4.43	5.81	13.1	0.01	3.06
<b>ECL class 2</b>									
ZTE	0.63	0.28	0.43	0.82	6.88	0.48	0.52	0.04	1.94
Nokia	1.89		3.30	1.64	0.60	14.8	18.8	0.16	47.5
Ericsson	0.29	0.22	0.25	0.20	0.58	5.78			0.09
Huawei	12.5	1.98	4.50	2.65	2.49	15.1	7.10		11.9
<i>Ublox</i>	0.26	0.29	0.28	0.26	3.15	13.6	11.5	0.01	25.1
<i>Quectel</i>	7.40	0.94	3.96	2.39	2.12	4.46	1.75	0.09	5.63
MTN	0.46	0.25	0.34	0.51	3.73	3.13	0.26	0.02	1.01
Vodacom	7.20	0.99	3.90	2.14	1.54	14.9	12.9	0.08	29.7

## A.4 Battery Longevity

Table 29: The table shows the mean longevity estimate (years) for 9.36Wh AA battery (Lithium Thionyl Chloride) with hourly uses.

	16 B	64 B	128 B	256 B	512 B	Echo	COPS	eDRX	PTAU
Ublox-ZTE	0.128	0.757	1.289	0.087	0.816	0.392	0.092	25.55	3.576
Quectel-ZTE	1.443	2.133	1.927	1.190	0.946	1.371	0.588	20.41	0.077
Ublox-Nokia	0.077	0.105	0.093	0.033	0.153	0.050	0.022	0.282	0.095
Quectel-Nokia	0.140	0.295	0.241	0.177	0.105	0.165	2.074	0.512	0.188
Ublox-Ericsson	3.909	4.564	3.665	2.354	1.463	0.108	0.340	17.37	6.393
Quectel-Ericsson	5.211	7.154	5.969	7.470	3.096	0.449	3.068	11.62	16.75
Ublox-Huawei	2.116	2.842	2.519	2.692	2.642	0.230	0.343	281.5	0.532
Quectel-Huawei	0.062	0.816	0.187	0.341	0.375	0.174	0.465	1242.	0.134
ZTE	0.236	1.118	1.545	0.162	0.876	0.610	0.159	22.69	0.151
Nokia	0.100	0.155	0.134	0.056	0.125	0.077	0.044	0.364	0.126
Ericsson	4.467	5.573	4.541	3.580	1.987	0.174	0.613	13.92	9.255
Huawei	0.120	1.268	0.349	0.606	0.656	0.198	0.395	459.1	0.214
<i>Ublox</i>	0.187	0.350	0.328	0.095	0.454	0.111	0.064	1.100	0.312
<i>Quectel</i>	0.166	0.766	0.394	0.419	0.295	0.271	0.859	1.918	0.155
MTN	0.448	1.862	2.306	0.311	1.216	0.271	0.252	17.26	0.298
Vodacom	0.109	0.276	0.194	0.103	0.210	0.111	0.079	0.728	0.159
<b>ECL class 0</b>									
ZTE	0.24	1.51	2.20	0.16	2.45	0.78	0.18	51.1	0.03
Nokia		11.4	1.57	6.97		0.05		0.09	0.96
Ericsson	12.8	16.5	14.0	12.5	11.4	1.34	0.64	10.6	26.4
Huawei	74.1	169.	200.	15.4	29.6	0.26	1.99	1492	13.0
<i>Ublox</i>	0.50	2.83	4.53	0.33	4.91	0.11	0.27	41.3	5.58
<i>Quectel</i>	10.6	18.5	2.75	3.74	16.4	0.23	10.1	0.18	0.05
MTN	0.48	2.77	3.81	0.31	4.04	0.99	0.28	17.5	0.06
Vodacom	148.	21.3	3.11	9.61	59.2	0.08	3.98	0.18	1.79
<b>ECL class 1</b>									
ZTE	6.58	4.92	6.59	0.33	1.83	3.50	0.85	1116	4.67
Nokia	0.09	0.15	0.13	0.05	0.11	0.08	0.04	44.8	0.16
Ericsson	2.49	3.01	2.29	1.45	0.83	0.14	3.16	523.	4.22
Huawei	5.49	11.9	7.26	1.02	1.98	2.43	0.26	600.	12.8
<i>Ublox</i>	0.29	0.39	0.34	0.10	0.40	0.14	0.07	316.	0.56
<i>Quectel</i>	0.48	0.94	0.83	0.47	0.35	0.38	0.77	97.8	0.66
MTN	3.61	3.73	3.40	0.54	1.15	0.27	1.34	713.	4.43
Vodacom	0.19	0.29	0.26	0.10	0.22	0.17	0.07	83.5	0.32
<b>ECL class 2</b>									
ZTE	1.57	3.55	2.31	1.21	0.14	2.04	1.90	20.7	0.51
Nokia	0.52		0.30	0.60	1.64	0.06	0.05	6.32	0.02
Ericsson	3.43	4.48	3.86	4.79	1.72	0.17			10.8
Huawei	0.07	0.50	0.22	0.37	0.40	0.06	0.14	190.	0.08
<i>Ublox</i>	3.81	3.35	3.49	3.80	0.31	0.07	0.08	86.6	0.03
<i>Quectel</i>	0.13	1.05	0.25	0.41	0.46	0.22	0.56	10.6	0.17
MTN	2.15	3.96	2.89	1.93	0.26	0.31	3.80	41.5	0.98
Vodacom	0.13	1.00	0.25	0.46	0.64	0.06	0.07	12.2	0.03

## B UE Reported Metric and Estimation Tables

### B.1 RF Transmit Time

Table 30: The table shows the mean UE reported transmit time (s)

	16 B	64 B	128 B	256 B	512 B	Echo	COPS	eDRX	PTAU
Ublox-ZTE	1.26	0.65	0.87	1.20	0.56	0.43	0.26		0.14
Quectel-ZTE	0.34	0.49	0.62	0.87	1.28	0.33	0.19	0.88	0.33
Ublox-Nokia	1.38	1.74	2.13	2.74	3.77	1.65	4.19	2.56	1.55
Quectel-Nokia	2.76					1.01	1.90	0.22	1.52
Ublox-Ericsson	0.43	0.49	0.58	0.81	1.16	1.57	0.07		0.38
Quectel-Ericsson	0.21	0.20	0.24	0.28	0.38	0.40	0.49		0.17
Ublox-Huawei	0.65	0.56	0.92	0.75	0.70	2.72			1.06
Quectel-Huawei	0.67	0.49	0.88	0.79	0.86	0.84	0.15		1.05
ZTE	0.80	0.57	0.74	1.04	0.92	0.38	0.23	0.44	0.23
Nokia	2.07	0.87	1.06	1.37	1.88	1.33	3.05	1.39	1.54
Ericsson	0.32	0.34	0.41	0.55	0.77	0.99	0.28		0.28
Huawei	0.66	0.52	0.90	0.77	0.78	1.78	0.07		1.06
<i>Ublox</i>	0.93	0.86	1.12	1.38	1.55	1.59	1.13	0.64	0.78
<i>Quectel</i>	0.99	0.29	0.43	0.48	0.63	0.65	0.69	0.27	0.77
MTN	0.56	0.46	0.58	0.79	0.85	0.69	0.25	0.22	0.26
Vodacom	1.37	0.70	0.98	1.07	1.33	1.56	1.56	0.69	1.30
<b>ECL class 0</b>									
ZTE	0.64	0.32	0.54	0.64	0.45	0.21	0.13		0.12
Nokia						2.70		0.11	0.38
Ericsson	0.17	0.18	0.20	0.25	0.33	0.20	0.12		0.14
Huawei	0.15	0.08	0.16	0.10	0.17	0.77			0.11
<i>Ublox</i>	0.35	0.26	0.32	0.37	0.36	1.04	0.08		0.15
<i>Quectel</i>	0.12	0.03	0.12	0.13	0.11	0.90	0.04	0.05	0.23
MTN	0.40	0.25	0.37	0.45	0.39	0.21	0.12		0.13
Vodacom	0.07	0.04	0.08	0.05	0.08	1.74		0.05	0.25
<b>ECL class 1</b>									
ZTE	1.08	0.12	0.17	0.15	0.27	0.04	0.07		0.06
Nokia	2.07	0.87	1.06	1.37	1.88	0.78	0.49	1.28	1.71
Ericsson	0.55	0.61	0.75	1.08	1.57	0.29	0.56		0.48
Huawei	0.28	0.24	0.42	0.32	0.66	0.96	0.07		0.32
<i>Ublox</i>	1.13	0.77	0.95	1.28	1.83	0.57		0.64	0.78
<i>Quectel</i>	0.87	0.15	0.25	0.18	0.35	0.46	0.60		0.50
MTN	0.82	0.36	0.46	0.62	0.92	0.16	0.31		0.27
Vodacom	1.18	0.55	0.74	0.84	1.27	0.87	0.28	0.64	1.01
<b>ECL class 2</b>									
ZTE	2.88	0.40	0.53	4.34	1.25	0.21	0.12	0.44	0.28
Nokia						2.51	4.90		
Ericsson	0.22	0.22	0.27	0.37	0.52	2.27			0.18
Huawei	1.29	1.56	1.52	1.55	1.17	3.54			2.19
<i>Ublox</i>	1.71	0.48	0.44	2.08	0.34	3.95	1.04		0.53
<i>Quectel</i>	0.48	0.61	0.71	1.05	1.13	0.31	1.46	0.22	0.79
MTN	1.55	0.31	0.40	2.35	0.88	1.24	0.06	0.22	0.23
Vodacom	0.64	0.78	0.76	0.77	0.58	3.03	2.45		1.09

## B.2 RF Receive Time

Table 31: The table shows the mean UE reported receive time (s)

	16 B	64 B	128 B	256 B	512 B	Echo	COPS	eDRX	PTAU
Ublox-ZTE	5.43	5.37	5.88	4.57	6.56	1.73	1.50	0.18	1.23
Quectel-ZTE	1.77	1.68	1.69	1.66	1.82	0.16	1.21	0.37	1.17
Ublox-Nokia	47.8	14.2	16.7	3.80	6.23	3.10	1.02	1.77	9.50
Quectel-Nokia	139.	162.	168.	159.	170.	1.78	6.39	18.6	6.13
Ublox-Ericsson	1.36	1.27	1.26	1.30	1.32	9.43		0.29	1.12
Quectel-Ericsson	1.42	1.26	1.26	1.24	1.35	10.3	1.76	0.30	0.93
Ublox-Huawei	0.99	0.81	0.85	0.86	0.98	74.4		0.64	4.49
Quectel-Huawei	26.2	3.41	3.39	7.17	5.06	29.8	5.59	0.37	6.50
ZTE	3.60	3.52	3.79	3.11	4.19	0.95	1.36	0.28	1.20
Nokia	93.6	88.1	92.5	81.6	88.1	2.44	3.70	10.2	7.82
Ericsson	1.39	1.27	1.26	1.27	1.33	9.91	0.88	0.29	1.02
Huawei	13.6	2.11	2.12	4.01	3.02	52.1	2.79	0.50	5.50
<i>Ublox</i>	13.9	5.42	6.20	2.63	3.77	22.1	0.63	0.72	4.09
<i>Quectel</i>	42.1	42.1	43.6	42.3	44.5	10.5	3.74	4.92	3.68
MTN	2.49	2.40	2.53	2.19	2.76	5.43	1.12	0.28	1.11
Vodacom	53.6	45.1	47.3	42.8	45.5	27.3	3.25	5.35	6.66
<b>ECL class 0</b>									
ZTE	3.60	2.68	3.69	3.22	3.01	0.86	0.75	0.09	1.16
Nokia	13.7					3.29			1.92
Ericsson	1.16	1.10	1.06	1.13	1.09	5.19	0.45	0.27	0.84
Huawei	0.28	0.17	0.86	0.18	0.32	39.4		0.11	1.27
<i>Ublox</i>	8.65	1.70	1.82	1.50	1.63	0.48	0.37	0.12	1.31
<i>Quectel</i>	0.74	0.27	0.98	0.77	0.57	23.9	0.22	0.12	1.28
MTN	2.38	1.89	2.38	2.18	2.05	3.03	0.60	0.18	1.00
Vodacom	7.00	0.08	0.43	0.09	0.16	21.3		0.05	1.59
<b>ECL class 1</b>									
ZTE	0.84	0.87	0.88	0.69	0.90	0.07	0.71	0.07	0.75
Nokia	102.	88.1	92.5	81.6	88.1	2.65	2.99	17.7	6.90
Ericsson	1.65	1.36	1.45	1.34	1.61	4.52	2.16	0.22	1.26
Huawei	0.94	1.02	1.30	1.09	1.32	46.7	2.79	0.48	1.20
<i>Ublox</i>	13.8	4.14	4.81	1.53	2.22	20.5		0.75	2.60
<i>Quectel</i>	39.0	41.5	43.2	40.8	43.7	6.51	4.33	8.52	2.45
MTN	1.25	1.11	1.16	1.01	1.26	2.30	1.44	0.14	1.00
Vodacom	51.6	44.5	46.9	41.3	44.7	24.7	2.89	9.13	4.05
<b>ECL class 2</b>									
ZTE	0.93	0.79	0.87	4.21	11.5	0.09	0.49	0.26	0.59
Nokia	20.4					0.93	3.60	1.08	28.7
Ericsson	1.04	0.92	0.95	0.88	1.02	5.48			0.73
Huawei	20.2	3.92	3.12	7.23	4.11	46.2		0.65	12.6
<i>Ublox</i>	0.47	0.42	0.43	2.07	5.65	24.5		0.36	17.1
<i>Quectel</i>	20.8	2.39	2.04	4.09	2.66	1.83	2.05	0.63	4.27
MTN	0.98	0.86	0.91	2.54	6.26	2.79	0.24	0.13	0.66
Vodacom	20.3	1.96	1.56	3.61	2.05	23.6	1.80	0.86	20.7



## B.3 Average Power Estimate

Table 32: The table shows the mean average power estimate ( $\mu Wh$ )

	16 B	64 B	128 B	256 B	512 B	Echo	COPS	eDRX	PTAU
Ublox-ZTE	640.80	484.70	570.30	574.20	533.60	211.30	155.00	10.80	108.80
Quectel-ZTE	191.20	223.30	256.40	317.10	429.20	92.10	120.10	22.20	152.70
Ublox-Nokia	3213.00	1287.00	1534.50	913.00	1316.30	598.50	1108.70	106.20	957.50
Quectel-Nokia	9030.00	9720.00	10080.00	9540.00	10200.00	359.30	858.40	1116.00	747.80
Ublox-Ericsson	189.10	198.70	220.60	280.50	369.20	958.30	17.50	17.40	162.20
Quectel-Ericsson	137.70	125.60	135.60	144.40	176.00	718.00	228.10	18.00	98.30
Ublox-Huawei	221.90	188.60	281.00	239.10	233.80	5144.00		38.40	534.40
Quectel-Huawei	1739.50	327.10	423.40	627.70	518.60	1998.00	372.90	22.20	652.50
ZTE	416.00	353.70	412.40	446.60	481.40	152.00	139.10	16.80	129.50
Nokia	6133.50	5503.50	5815.00	5238.50	5756.00	478.90	984.50	612.00	854.20
Ericsson	163.40	161.20	178.10	213.70	272.30	842.10	122.80	17.40	131.20
Huawei	981.00	256.60	352.20	433.10	376.20	3571.00	184.90	30.00	595.00
Ublox	1066.50	540.20	652.00	502.80	613.70	1723.50	320.30	43.20	440.40
Quectel	2773.50	2598.50	2723.50	2658.00	2827.50	792.50	396.90	295.20	413.30
MTN	289.40	259.00	296.80	328.90	378.10	498.30	129.70	16.80	131.60
Vodacom	3558.50	2881.00	3083.00	2835.50	3062.50	2028.00	585.00	321.00	724.60
<b>ECL class 0</b>									
ZTE	376.00	240.80	356.40	353.20	293.10	104.10	77.50	5.40	99.60
Nokia	822.00					872.40			210.20
Ericsson	112.10	111.00	113.60	130.30	147.90	361.40	57.00	16.20	85.40
Huawei	54.30	30.20	91.60	35.80	61.70	2556.50		6.60	103.70
Ublox	606.50	167.00	189.20	182.50	187.80	288.80	42.20	7.20	116.10
Quectel	74.40	23.70	88.80	78.70	61.70	1659.00	23.20	7.20	134.30
MTN	242.80	175.90	235.30	243.30	220.50	234.30	66.00	10.80	92.50
Vodacom	437.50	14.80	45.80	17.90	29.60	1713.00		3.00	157.90
<b>ECL class 1</b>									
ZTE	320.40	82.20	95.30	78.90	121.50	14.20	60.10	4.20	60.00
Nokia	6637.50	5503.50	5815.00	5238.50	5756.00	354.00	301.90	1062.00	841.50
Ericsson	236.50	234.10	274.50	350.40	489.10	343.70	269.60	13.20	195.60
Huawei	126.40	121.20	183.00	145.40	244.20	3042.00	184.90	28.80	152.00
Ublox	1110.50	440.90	526.10	411.80	590.70	1372.50		45.00	351.00
Quectel	2557.50	2527.50	2654.50	2493.00	2709.50	505.60	409.80	511.20	272.00
MTN	280.00	156.60	184.60	215.60	305.60	178.00	163.90	8.40	127.50
Vodacom	3391.00	2807.50	2999.00	2688.00	2999.50	1699.50	243.40	547.80	495.50
<b>ECL class 2</b>									
ZTE	775.80	147.40	184.70	1337.60	1002.50	57.90	59.40	15.60	105.40
Nokia	1224.00					683.30	1441.00	64.80	1722.00
Ericsson	117.40	110.20	124.50	145.30	191.20	896.30			88.80
Huawei	1534.50	625.20	567.20	821.30	539.10	3657.00		39.00	1303.50
Ublox	455.70	145.20	135.80	644.20	424.00	2457.50	260.00	21.60	1158.50
Quectel	1368.00	295.90	299.90	507.90	442.10	187.30	488.00	37.80	453.70
MTN	446.30	129.10	154.60	739.90	595.60	477.40	29.40	7.80	97.10
Vodacom	1378.00	312.60	283.60	409.10	268.00	2173.50	720.50	51.60	1514.50

## B.4 Telemetry Interval

Table 33: The table shows the mean interval estimate in minutes using reported transmit and receive time in average power estimations for 9.36Wh AA battery (Lithium Thionyl Chloride) to last 1 year.

	16 B	64 B	128 B	256 B	512 B	Echo	COPS	eDRX	PTAU
Ublox-ZTE	35.98	27.22	32.02	32.24	29.96	11.87	8.70	0.61	6.11
Quectel-ZTE	10.74	12.54	14.40	17.81	24.10	5.17	6.74	1.25	8.57
Ublox-Nokia	180.42	72.27	86.17	51.27	73.92	33.61	62.26	5.96	53.77
Quectel-Nokia	507.07	545.82	566.03	535.71	572.77	20.18	48.20	62.67	41.99
Ublox-Ericsson	10.62	11.16	12.39	15.75	20.73	53.81	0.98	0.98	9.11
Quectel-Ericsson	7.73	7.05	7.61	8.11	9.88	40.32	12.81	1.01	5.52
Ublox-Huawei	12.46	10.59	15.78	13.43	13.13	288.86		2.16	30.01
Quectel-Huawei	97.68	18.37	23.78	35.25	29.12	112.20	20.94	1.25	36.64
ZTE	23.36	19.86	23.16	25.08	27.03	8.54	7.81	0.94	7.27
Nokia	344.42	309.04	326.53	294.16	323.22	26.89	55.28	34.37	47.97
Ericsson	9.18	9.05	10.00	12.00	15.29	47.29	6.90	0.98	7.37
Huawei	55.09	14.41	19.78	24.32	21.13	200.53	10.38	1.68	33.41
Ublox	59.89	30.33	36.61	28.23	34.46	96.78	17.99	2.43	24.73
Quectel	155.74	145.92	152.94	149.26	158.78	44.50	22.29	16.58	23.21
MTN	16.25	14.54	16.67	18.47	21.23	27.98	7.28	0.94	7.39
Vodacom	199.82	161.78	173.12	159.22	171.97	113.88	32.85	18.03	40.69
<b>ECL class 0</b>									
ZTE	21.11	13.52	20.01	19.83	16.46	5.85	4.35	0.30	5.59
Nokia	46.16					48.99			11.80
Ericsson	6.29	6.23	6.38	7.32	8.31	20.29	3.20	0.91	4.80
Huawei	3.05	1.70	5.14	2.01	3.46	143.56		0.37	5.82
Ublox	34.06	9.38	10.62	10.25	10.55	16.22	2.37	0.40	6.52
Quectel	4.18	1.33	4.99	4.42	3.46	93.16	1.30	0.40	7.54
MTN	13.63	9.88	13.21	13.66	12.38	13.16	3.71	0.61	5.19
Vodacom	24.57	0.83	2.57	1.01	1.66	96.19		0.17	8.87
<b>ECL class 1</b>									
ZTE	17.99	4.62	5.35	4.43	6.82	0.80	3.37	0.24	3.37
Nokia	372.72	309.04	326.53	294.16	323.22	19.88	16.95	59.64	47.25
Ericsson	13.28	13.15	15.41	19.68	27.46	19.30	15.14	0.74	10.98
Huawei	7.10	6.81	10.28	8.16	13.71	170.82	10.38	1.62	8.54
Ublox	62.36	24.76	29.54	23.12	33.17	77.07		2.53	19.71
Quectel	143.61	141.93	149.06	139.99	152.15	28.39	23.01	28.71	15.27
MTN	15.72	8.79	10.37	12.11	17.16	10.00	9.20	0.47	7.16
Vodacom	190.42	157.65	168.41	150.94	168.43	95.43	13.67	30.76	27.82
<b>ECL class 2</b>									
ZTE	43.56	8.28	10.37	75.11	56.29	3.25	3.34	0.88	5.92
Nokia	68.73					38.37	80.92	3.64	96.70
Ericsson	6.59	6.19	6.99	8.16	10.74	50.33			4.99
Huawei	86.17	35.11	31.85	46.12	30.27	205.35		2.19	73.20
Ublox	25.59	8.15	7.63	36.17	23.81	138.00	14.60	1.21	65.05
Quectel	76.82	16.62	16.84	28.52	24.83	10.52	27.40	2.12	25.48
MTN	25.06	7.25	8.68	41.55	33.45	26.81	1.65	0.44	5.45
Vodacom	77.38	17.55	15.93	22.97	15.05	122.05	40.46	2.90	85.05

## B.5 Battery Longevity

Table 34: The table shows the mean longevity estimate in years using reported transmit and receive time for 9.36Wh AA battery (Lithium Thionyl Chloride) with hourly uses.

	16 B	64 B	128 B	256 B	512 B	Echo	COPS	eDRX	PTAU
Ublox-ZTE	1.67	2.20	1.87	1.86	2.00	5.06	6.89	98.93	9.82
Quectel-ZTE	5.59	4.79	4.17	3.37	2.49	11.60	8.90	48.13	7.00
Ublox-Nokia	0.33	0.83	0.70	1.17	0.81	1.79	0.96	10.06	1.12
Quectel-Nokia	0.12	0.11	0.11	0.11	0.10	2.97	1.24	0.96	1.43
Ublox-Ericsson	5.65	5.38	4.84	3.81	2.89	1.11	61.06	61.41	6.59
Quectel-Ericsson	7.76	8.51	7.88	7.40	6.07	1.49	4.68	59.36	10.87
Ublox-Huawei	4.82	5.67	3.80	4.47	4.57	0.21		27.83	2.00
Quectel-Huawei	0.61	3.27	2.52	1.70	2.06	0.53	2.87	48.13	1.64
ZTE	2.57	3.02	2.59	2.39	2.22	7.03	7.68	63.60	8.25
Nokia	0.17	0.19	0.18	0.20	0.19	2.23	1.09	1.75	1.25
Ericsson	6.54	6.63	6.00	5.00	3.92	1.27	8.70	61.41	8.14
Huawei	1.09	4.16	3.03	2.47	2.84	0.30	5.78	35.62	1.80
Ublox	1.00	1.98	1.64	2.13	1.74	0.62	3.34	24.73	2.43
Quectel	0.39	0.41	0.39	0.40	0.38	1.35	2.69	3.62	2.59
MTN	3.69	4.13	3.60	3.25	2.83	2.14	8.24	63.60	8.12
Vodacom	0.30	0.37	0.35	0.38	0.35	0.53	1.83	3.33	1.47
<b>ECL class 0</b>									
ZTE	2.84	4.44	3.00	3.03	3.65	10.26	13.79	197.87	10.73
Nokia	1.30					1.22			5.08
Ericsson	9.53	9.63	9.41	8.20	7.22	2.96	18.75	65.96	12.51
Huawei	19.68	35.38	11.66	29.85	17.32	0.42		161.89	10.30
Ublox	1.76	6.40	5.65	5.85	5.69	3.70	25.32	148.40	9.20
Quectel	14.36	45.08	12.03	13.58	17.32	0.64	46.06	148.40	7.96
MTN	4.40	6.07	4.54	4.39	4.85	4.56	16.19	98.93	11.55
Vodacom	2.44	72.20	23.33	59.69	36.10	0.62		356.16	6.77
<b>ECL class 1</b>									
ZTE	3.33	13.00	11.21	13.54	8.79	75.25	17.78	254.40	17.81
Nokia	0.16	0.19	0.18	0.20	0.19	3.02	3.54	1.01	1.27
Ericsson	4.52	4.56	3.89	3.05	2.18	3.11	3.96	80.95	5.46
Huawei	8.45	8.82	5.84	7.35	4.38	0.35	5.78	37.10	7.03
Ublox	0.96	2.42	2.03	2.59	1.81	0.78		23.74	3.04
Quectel	0.42	0.42	0.40	0.43	0.39	2.11	2.61	2.09	3.93
MTN	3.82	6.82	5.79	4.96	3.50	6.00	6.52	127.20	8.38
Vodacom	0.32	0.38	0.36	0.40	0.36	0.63	4.39	1.95	2.16
<b>ECL class 2</b>									
ZTE	1.38	7.25	5.79	0.80	1.07	18.45	17.99	68.49	10.14
Nokia	0.87					1.56	0.74	16.49	0.62
Ericsson	9.10	9.70	8.58	7.35	5.59	1.19			12.03
Huawei	0.70	1.71	1.88	1.30	1.98	0.29		27.40	0.82
Ublox	2.34	7.36	7.87	1.66	2.52	0.43	4.11	49.47	0.92
Quectel	0.78	3.61	3.56	2.10	2.42	5.70	2.19	28.27	2.36
MTN	2.39	8.28	6.91	1.44	1.79	2.24	36.34	136.99	11.00
Vodacom	0.78	3.42	3.77	2.61	3.99	0.49	1.48	20.71	0.71

## B.6 Signal to Noise Ratio

Table 35: The table shows the mean UE reported SINR (dB)

	16 B	64 B	128 B	256 B	512 B	Echo	COPS	eDRX	PTAU
Ublox-ZTE	4.9157	4.8879	4.4467	5.1152	3.8929	1.7888	3.9665	1.8265	2.7666
Quectel-ZTE	3.9372	3.1366	3.1214	3.3533	3.5933	1.8872	1.5103	0.6386	3.1138
Ublox-Nokia	2.0557	0.4166	-1.070	4.3916	5.0888	6.0039	2.2833	2.5903	5.0884
Quectel-Nokia	3.5555	4.4083	4.7166	4.6615	5.1000	6.4396	-0.216	1.2780	6.5623
Ublox-Ericsson	24.300	24.270	24.499	24.460	24.467	3.2116	26.650	21.463	24.172
Quectel-Ericsson	21.869	22.157	21.783	21.762	21.815	20.293	19.882	21.600	22.061
Ublox-Huawei	4.8695	5.1962	5.1842	4.3222	5.0370	4.7015	9.9333	4.1742	8.9391
Quectel-Huawei	-0.113	-0.236	-0.695	0.6055	-0.561	2.4851	3.5799	6.9740	6.5452
ZTE	4.4264	4.0123	3.7840	4.2343	3.7431	1.8380	2.7384	1.2325	2.9402
Nokia	2.8056	2.4124	1.8233	4.5266	5.0944	6.2217	1.0333	1.9341	5.8254
Ericsson	23.085	23.213	23.141	23.111	23.141	11.752	23.266	21.531	23.116
Huawei	2.3780	2.4800	2.2442	2.4638	2.2379	3.5933	6.7566	5.5741	7.7421
<i>Ublox</i>	9.0353	8.6928	8.2650	9.5724	9.6215	3.9265	10.708	7.5137	10.241
<i>Quectel</i>	7.3122	7.3665	7.2315	7.5958	7.4868	7.7763	6.1890	7.6226	9.5706
MTN	13.755	13.613	13.462	13.673	13.442	6.7953	13.002	11.382	13.028
Vodacom	2.5918	2.4462	2.0337	3.4952	3.6662	4.9075	3.8950	3.7541	6.7838
<b>ECL class 0</b>									
ZTE	7.21	2.44	5.77	7.07	7.48	0.89	1.98	0.91	6.92
Nokia	3.47	4.05	3.75	3.70		8.59		9.49	6.73
Ericsson	28.1	28.2	28.0	28.0	27.9	12.7	26.2	23.1	28.1
Huawei	7.51	3.83	7.55	7.52	4.07	7.94	11.4	5.46	11.7
<i>Ublox</i>	12.3	10.2	10.4	10.5	10.6	5.03	10.9	5.82	12.4
<i>Quectel</i>	10.8	8.99	12.1	12.6	9.09	10.0	8.93	13.6	14.2
MTN	17.6	15.3	16.8	17.5	17.7	6.83	14.1	12.0	17.5
Vodacom	5.49	3.94	5.65	5.61	2.03	8.27	5.74	7.48	9.23
<b>ECL class 1</b>									
ZTE	3.14	2.56	2.46	0.31	2.90	1.17	0.64	1.13	3.43
Nokia	3.03	2.24	2.10	4.65	5.58	6.36	2.10	4.34	5.70
Ericsson	17.1	17.9	17.7	17.9	18.0	7.06	7.26	4.65	17.5
Huawei	4.03	4.44	3.31	2.46	2.97	4.08	4.88	6.66	10.4
<i>Ublox</i>	4.58	4.44	3.80	3.80	5.03	3.77	2.20	2.16	7.88
<i>Quectel</i>	9.10	9.13	9.02	8.90	9.74	5.56	5.24	6.23	10.6
MTN	10.1	10.2	10.1	9.15	10.5	4.12	3.95	2.89	10.4
Vodacom	3.53	3.34	2.70	3.56	4.27	5.22	3.49	5.50	8.09
<b>ECL class 2</b>									
ZTE	-0.6	0.07	-0.0	0.16	-4.8	0.61	0.86	-0.4	-0.0
Nokia	-1.1		-1.8	-0.4	-2.8	-3.4	-1.5	-1.4	3.87
Ericsson	3.46	3.58	3.79	3.53	3.71	2.43	3.44		3.41
Huawei	-1.3	-1.8	-0.9	-0.4	-0.5	-3.1	-1.4	1.41	1.44
<i>Ublox</i>	-0.1	0.14	0.13	0.08	-1.7	-1.8	0.57	1.11	2.22
<i>Quectel</i>	0.36	0.73	0.36	1.30	-0.4	0.10	0.10	-1.4	2.10
MTN	1.43	1.82	1.89	1.85	-0.5	1.52	2.15	-0.2	1.66
Vodacom	-1.2	-0.9	-1.3	-0.4	-1.6	-3.3	-1.4	-0.0	2.65

C METRIC AND ESTIMATION PLOTS

## C Metric and Estimation Plots

These plots show the entire dataset through different aspects, with the format explained in §3.7.2.3.

### C.1 Latency

UE reported and measured latency values are shown in this section. Measured latency shows the duration of time that each datagram took to complete and is measured using the energy capture device in §3.3.1.3, hence latency.

#### C.1.1 Measured latency

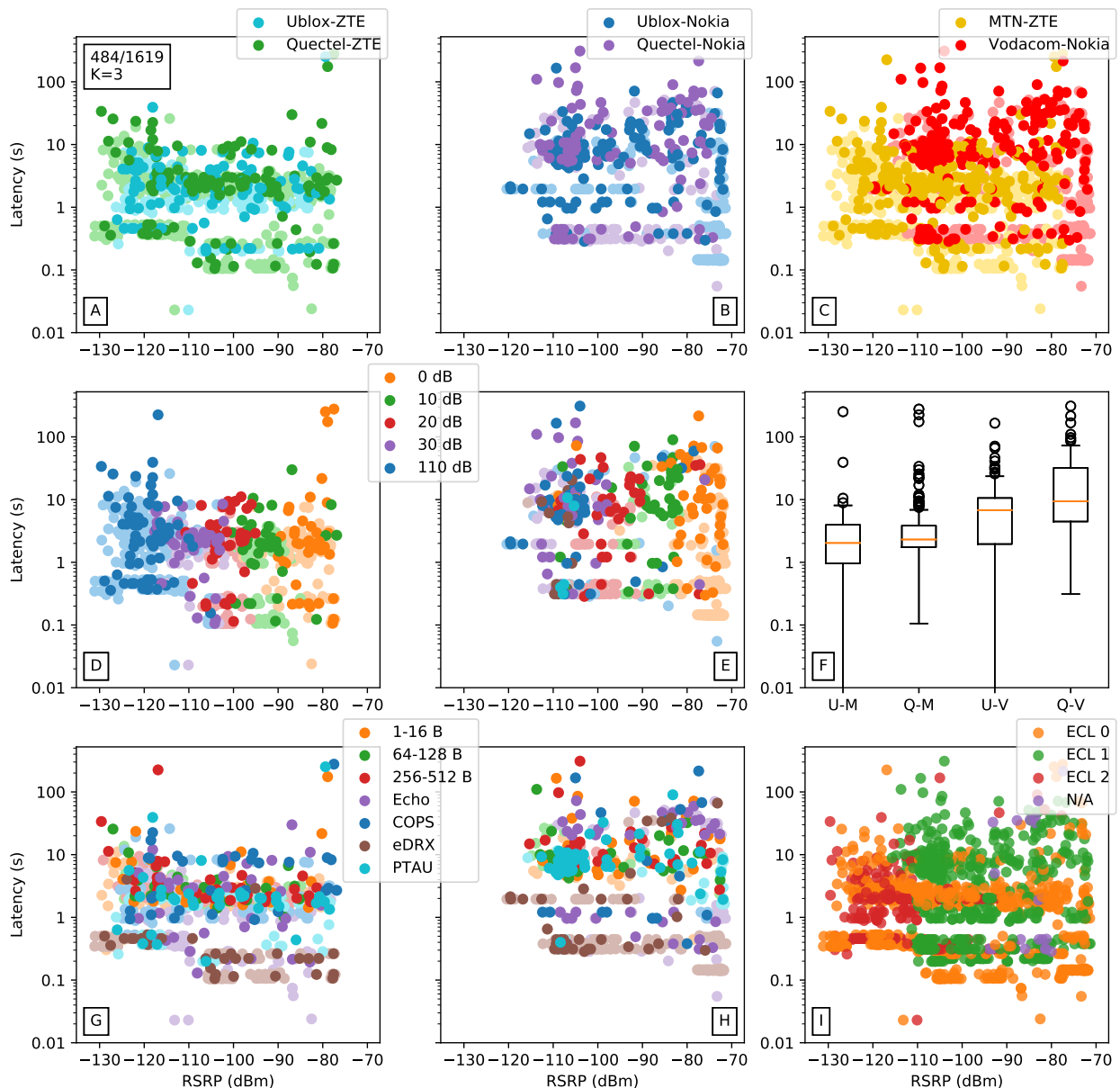


Figure C.1: Latency points (484/1619) in comparison (AB) of UE, (C) MNOs, (DE) attenuation zones, (F) UE-MNO boxplots, (GH) test types, (I) and ECLs against RSRP for ZTE, Nokia.

In Figure C.1 (ABCF) the characteristics of each MNO is distributed more evenly. RSRP measurements are across a 50dBm range for MTN-ZTE and Vodacom-Nokia with the weakest signals around -130dBm and -120dBm respectively. (DE) Attenuation per decade is evident according to RSRP. This RF metric is most beneficial to compare against when measuring the outcome of attenuations. (GH) Tests are varied across RSRP. (G) eDRX paging cycles and PTAU have the quickest latencies under a few seconds whilst COPS has the longest up to 10 seconds. (H) Echo tests have outlier network (de)registrations at Vodacom-Nokia. UDP packet byte size has high variability, yet only has an effect on latency in the fastest transmissions. (I) Most of Vodacom-Nokia's dataset is on ECL class 1, yet MTN-ZTE's ECL class 1 has much lower latency and variability. Increased ECL classes do not necessarily correlate with latency. Closer inspection is needed per test. Extended Coverage Levels (ECL) are determined by the network. The eNB (base station) sets the number of transmission repetitions (ECL) according to received signal strength reported by the UE. Extreme outliers are not cased by attenuation, but rather network controlled.

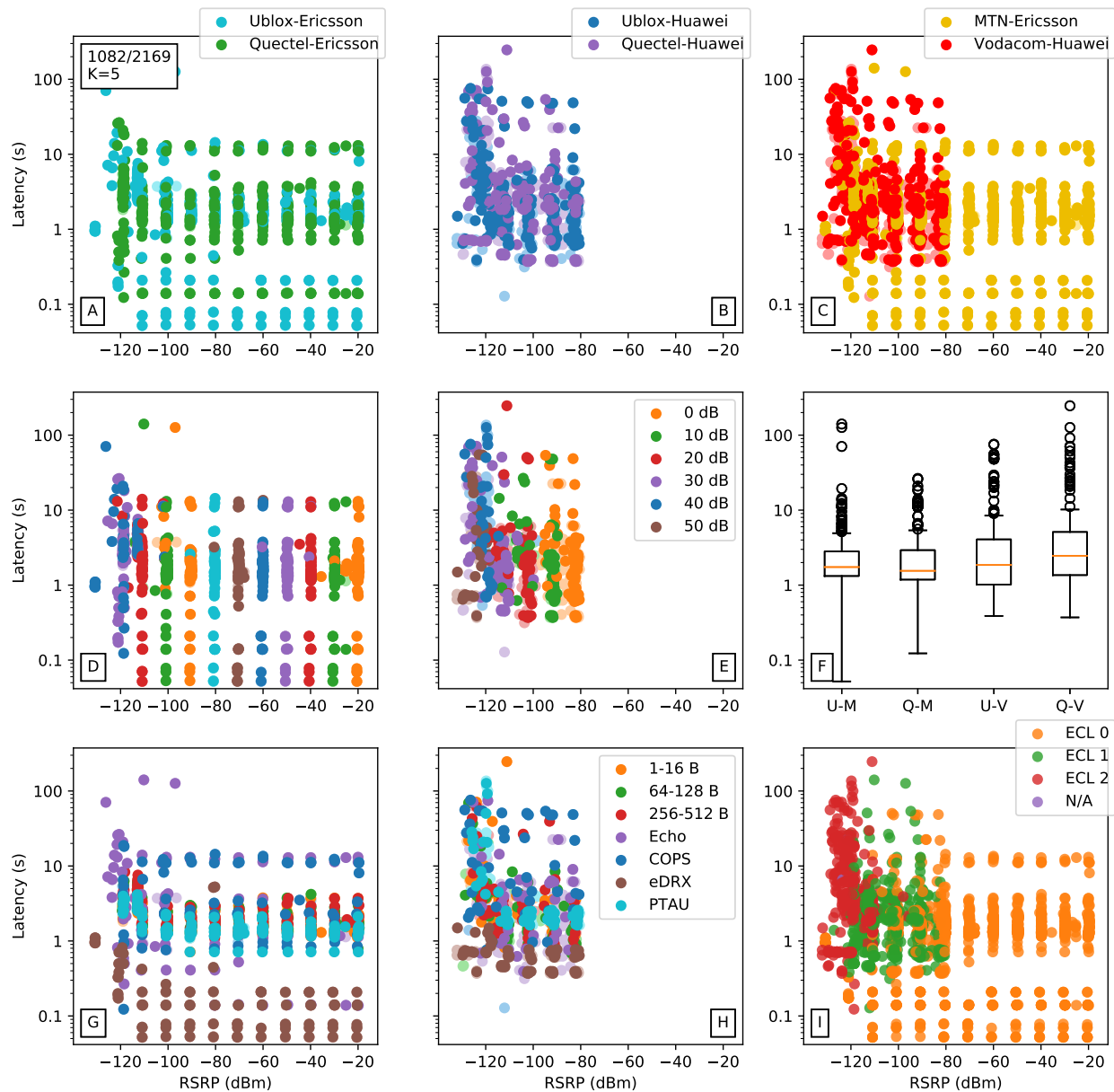


Figure C.2: Latency points (1082/2169) in comparison (AB) of UE, (C) MNOs, (DE) attenuation zones, (F) UE-MNO boxplots, (GH) test types, (I) and ECLs against RSRP for Huawei, Ericsson. In Figure C.2, variability between Quectel Ublox differs slightly, else they share similar traits. Ericsson shows slightly less latency on the MTN network.

C.1.2 UE Reported Transmit Latency

The UE reports TX and RX time via the AT+NUESTATS="RADIO" command. It is the transmit and receive time spent on air (using its allocated bandwidth in the RF spectrum).

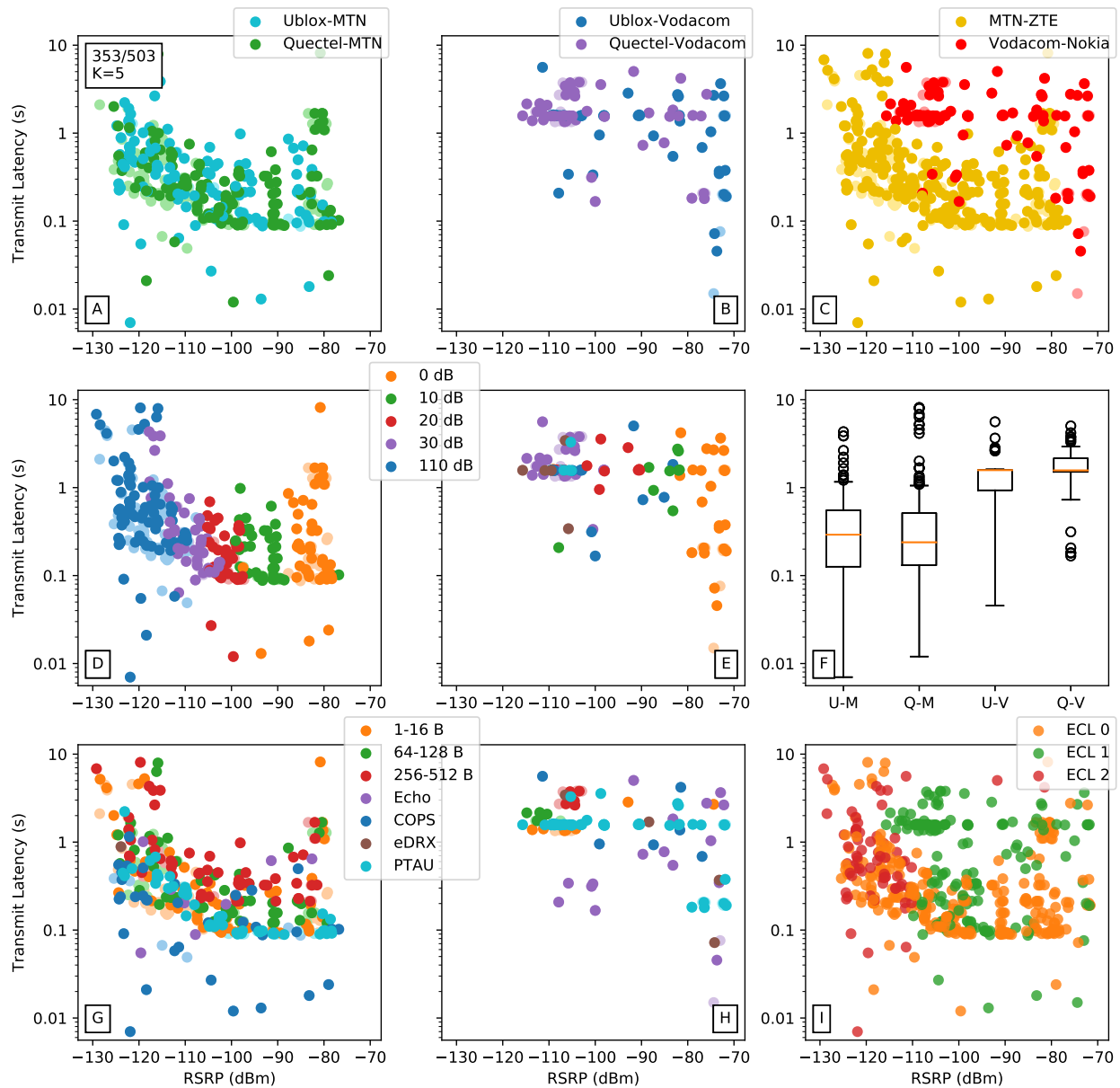


Figure C.3: TX time points (353/503) in comparison (AB) of UE, (C) MNOs, (DE) attenuation zones, (F) UE-MNO boxplots, (GH) test types, (I) and ECLs against RSRP for ZTE, Nokia.

In Figure C.3, (AF) the effect of K-means clustering can be seen as it simplifies the variability around -110 to -130dBm as more tests had been take than necessary. Nevertheless, this coincides with (I) higher ECL class 2 values. However, ECL is not the only metric that affects latency as there are ECL class 0 values in that range as well. As a whole, the UE have low latency and means under 1 second with MTN-ZTE. (BF) Ublox shows poorer performance than Quectel here, yet both have means around 2-3 seconds. In (C), the data is almost mutually exclusive and only shares a boundary with TX times under 2 seconds. (DE) Attenuation zones are clearly defined per decade. (GH) UDP packet transmissions are reported greater than 5 seconds, and the rest of the tests as less. (I) ECL might affect latency according to reported TX time.

Although the UE reports satisfactory TX time according to 3GPP standards (under 10 seconds) it is not

indicative of the measured latency and it is likely necessary to look at RX time as well. Data for both MNOs falls within the first 5 seconds, unlike what was measured. It is possible that actual on-air time is less than when measuring latency from external energy measurements because the signals are modulated in the time domain (duty cycle, pulse width). In terms of outliers, if not a lengthy UDP packet transmission, both eDRX and PTAU have a single outlier which could be a result of an RRC connection with a long inactivity timer, synchronization error or else.

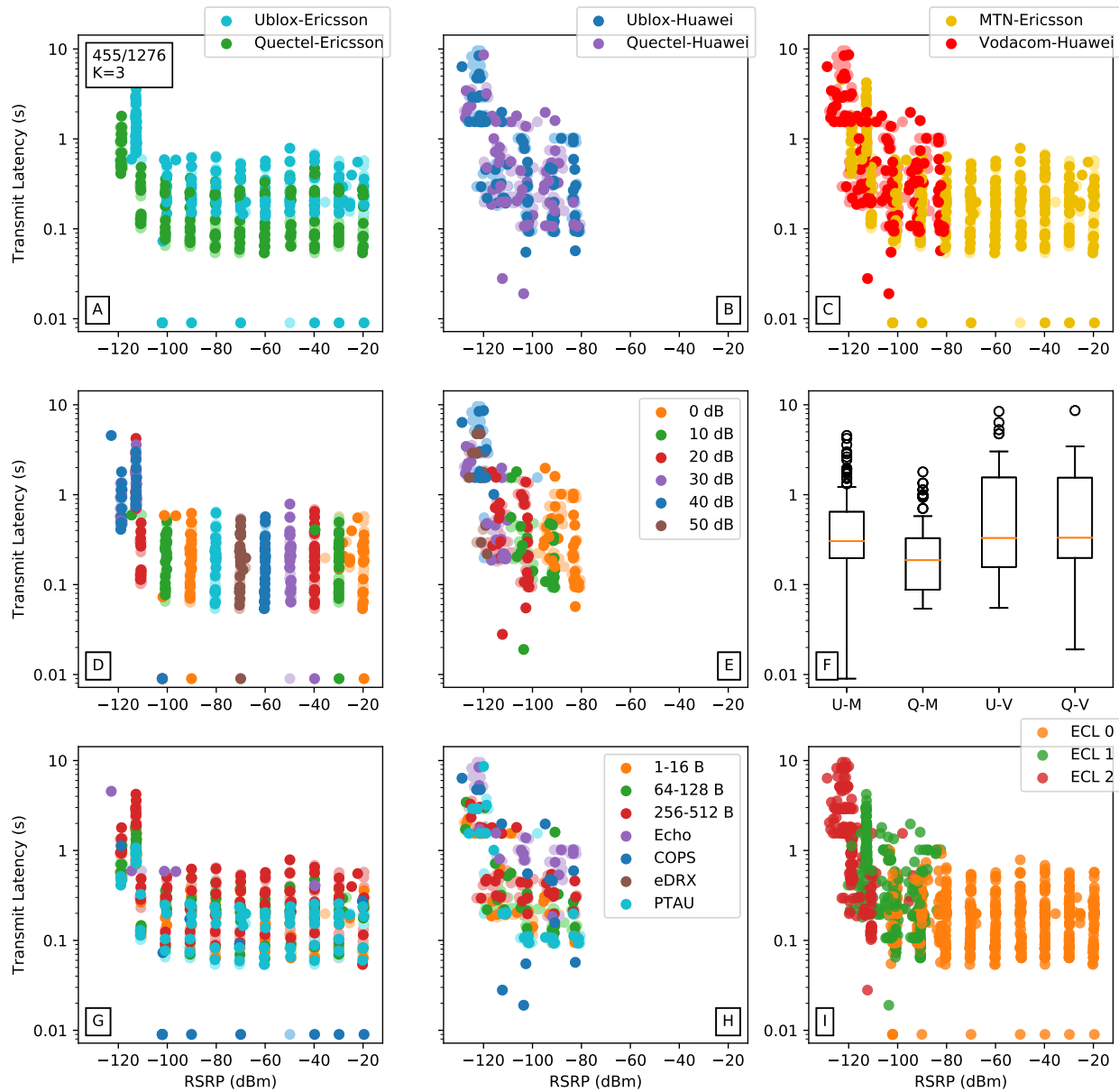


Figure C.4: TX time points (455/1276) in comparison (AB) of UE, (C) MNOs, (DE) attenuation zones, (F) UE-MNO boxplots, (GH) test types, (I) and ECLs against RSRP for Ericsson, Huawei.



C.1.3 UE Reported Receive Latency

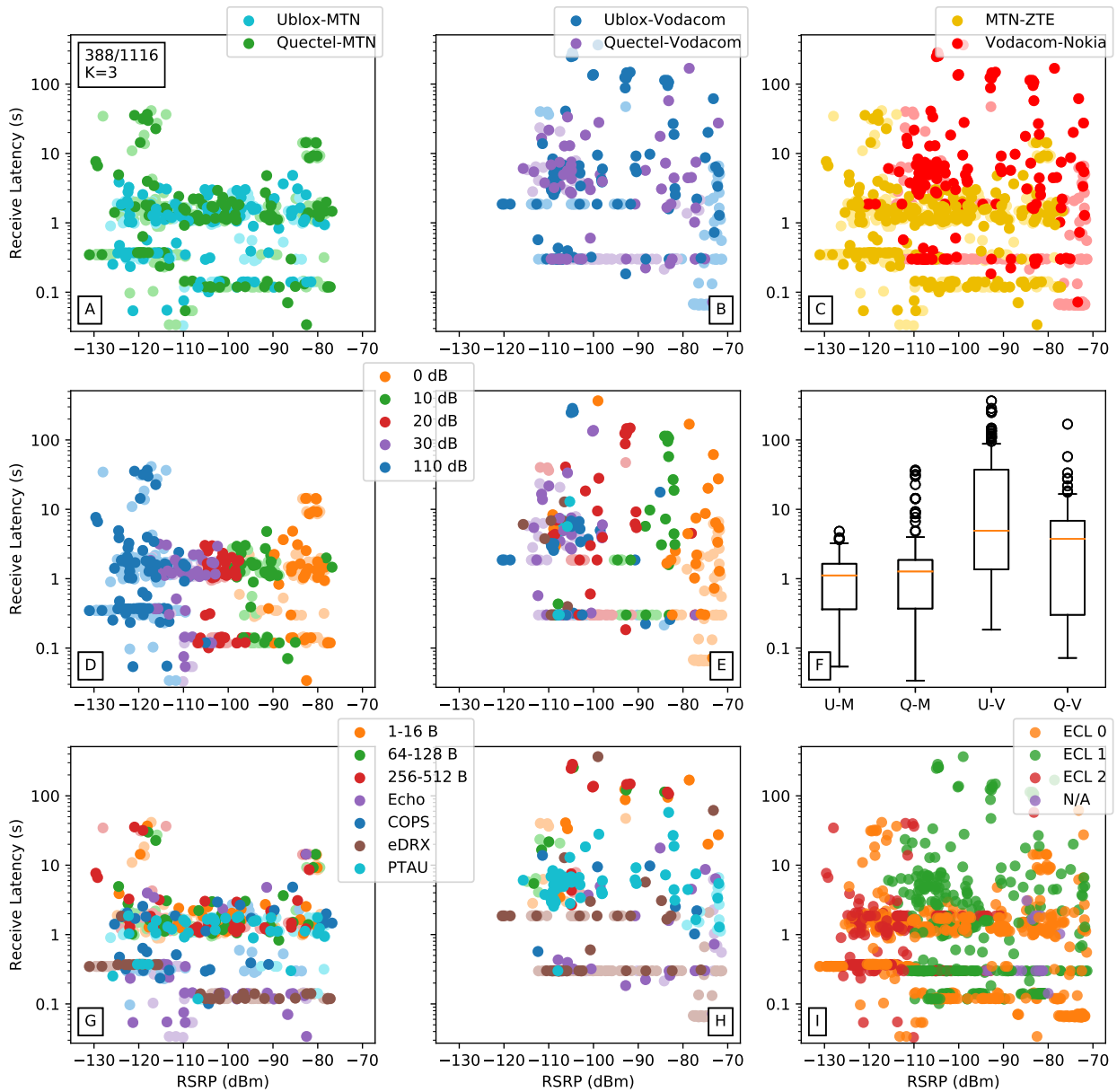


Figure C.5: RX time packets (388/1116) in comparison (AB) of UE, (C) MNOs, (DE) attenuation zones, (F) UE-MNO boxplots, (GH) test types, (I) and ECLs against RSRP for ZTE, Nokia.

In Figure C.5, attenuation zones are clearly defined per decade. ZTE’s RX and TX time centered mainly within 2.5 seconds and Nokia’s mainly around 10 seconds. All telemetry tests show variation in RX time except eDRX. ECL classes do not affect RX time on ZTE, however most of the tests on Nokia show ECL class 1 and above. The on-air time for receiving from the network is at least twice as much as the TX time metric. It is more comparable to the external energy-latency measurements and suggests that more energy is spent on receiving than necessary. Outliers show RX time up to almost 400 seconds and majority when connected to Vodacom towers. It includes mostly the UDP packet tests and at ECL class 1.

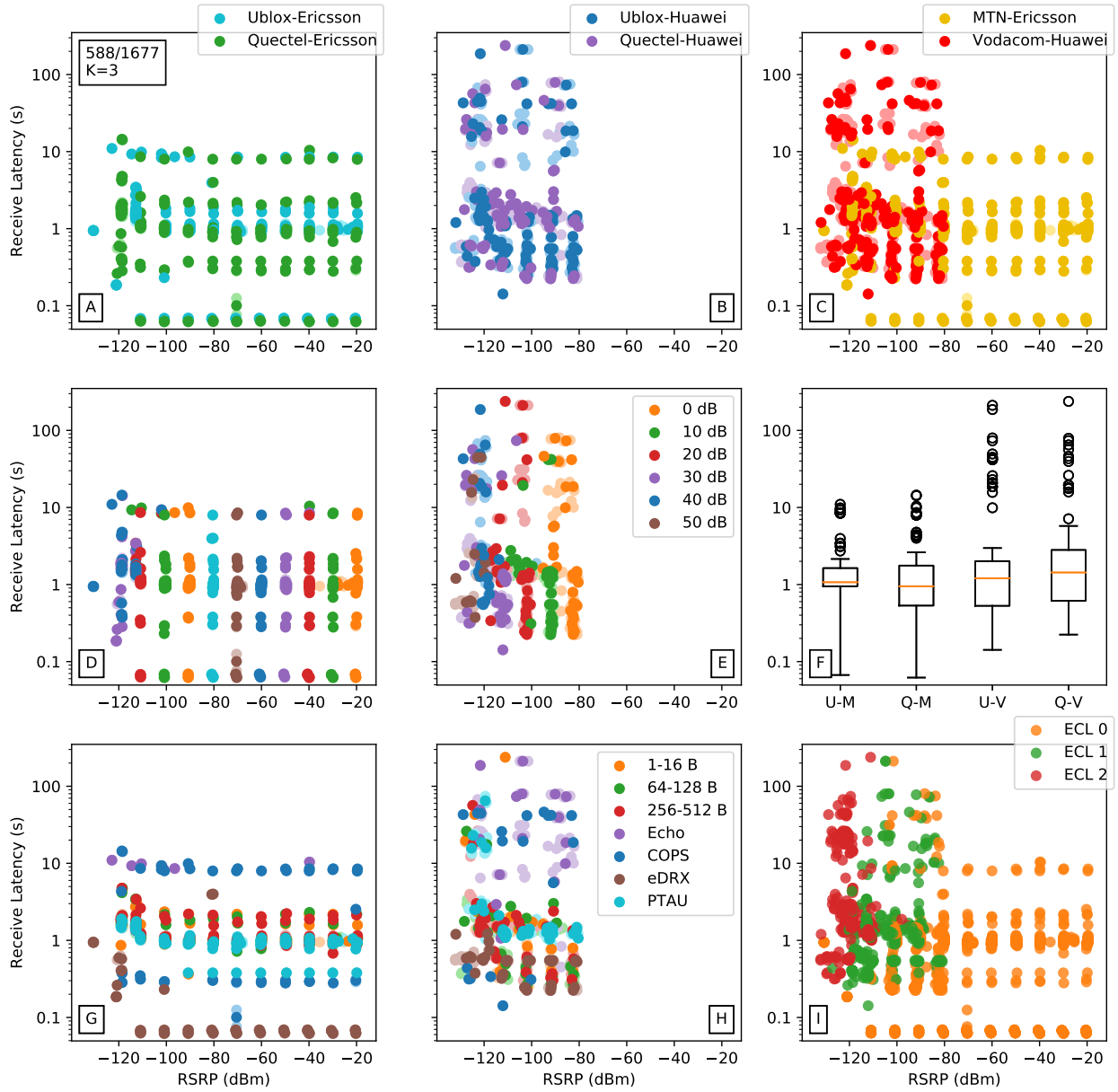


Figure C.6: RX time packets (588/1677) in comparison (AB) of UE, (C) MNOs, (DE) attenuation zones, (F) UE-MNO boxplots, (GH) test types, (I) and ECLs against RSRP for Ericsson, Huawei.

## C.2 Power Efficiency

### C.2.1 Measured Energy Consumption

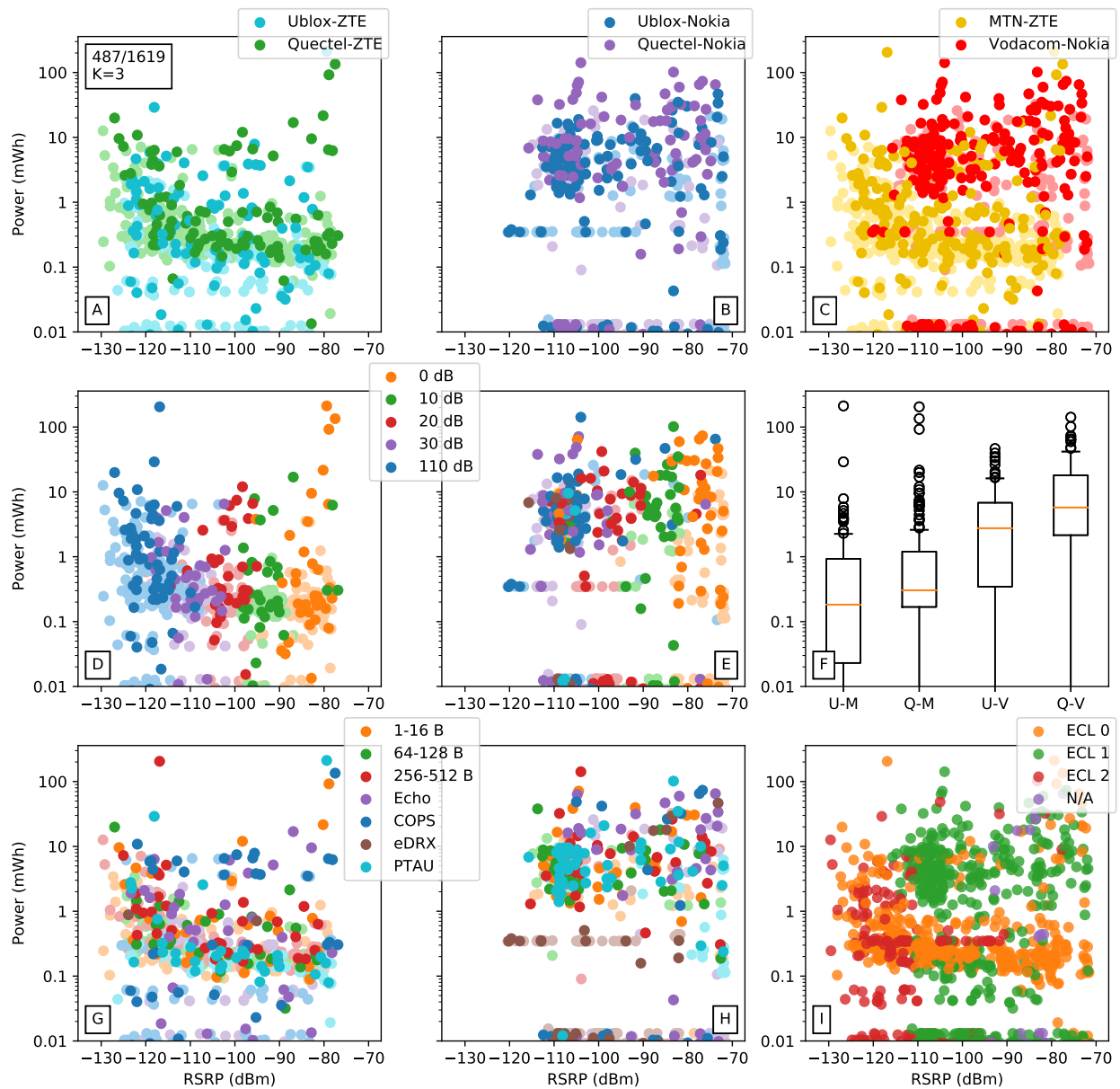


Figure C.7: Energy packets (487/1619) in comparison (AB) of UE, (C) MNOs, (DE) attenuation zones, (F) UE-MNO boxplots, (GH) test types, (I) and ECLs against RSRP for ZTE, Nokia.

In Figure C.7, attenuation zones per decade are evident. Nokia energy consumption is up to 10 times greater, excluding outliers. All tests show variation in energy consumption except eDRX. Nokia is at mostly ECL class 1, yet ZTE has varied ECL. Energy outliers mainly from Nokia at ECL class 1 and the COPS, PTAU or UDP packet test. All in all, Nokia uses up to 40 times (200 Joules) more than ZTE (up to 5 Joules).

On a generic 3.7V lithium battery with 4Ah of storage, it has 14800mWh in total. In worst case scenarios, at 14mWh it will last for 1057 transmissions, and at the outlying 200mWh it will last for 74 transmissions. In terms of ZTE, at 5 Joules (1.4mWh) there are 10570 transmissions available, and with Nokia at 200 Joules (56mWh) it will last for 266 transmissions. With daily transmissions, one can hope for a year when connected to Nokia, and with ZTE it far exceeds the 10 year 3GPP standard with 28 years. This leaves enough room for

scheduled downlink transmissions using eDRX.

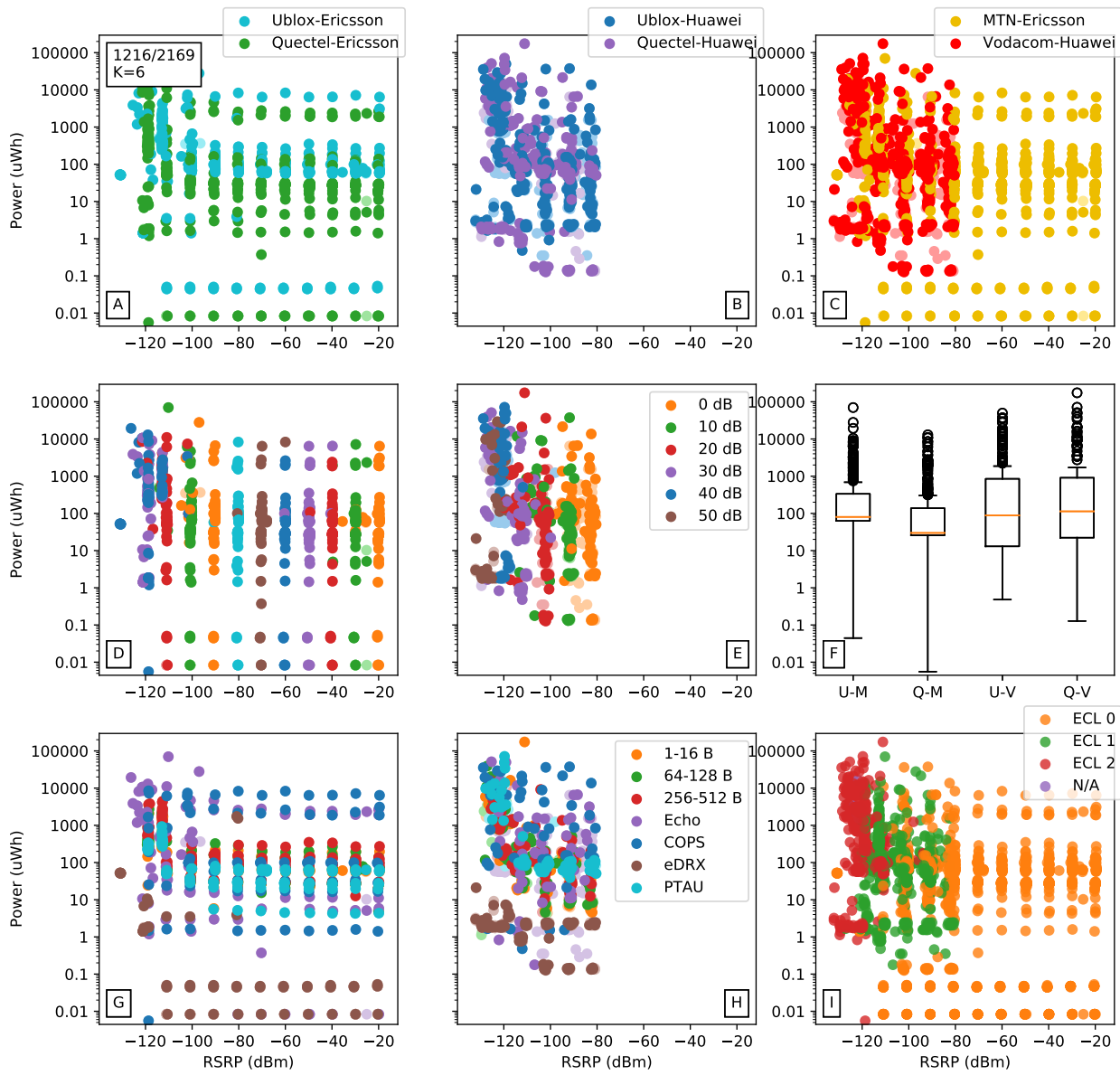


Figure C.8: Energy packets (1216/2169) in comparison (AB) of UE, (C) MNOs, (DE) attenuation zones, (F) UE-MNO boxplots, (GH) test types, (I) and ECLs against RSRP for Ericsson, Huawei.

C.2.2 Energy vs Latency

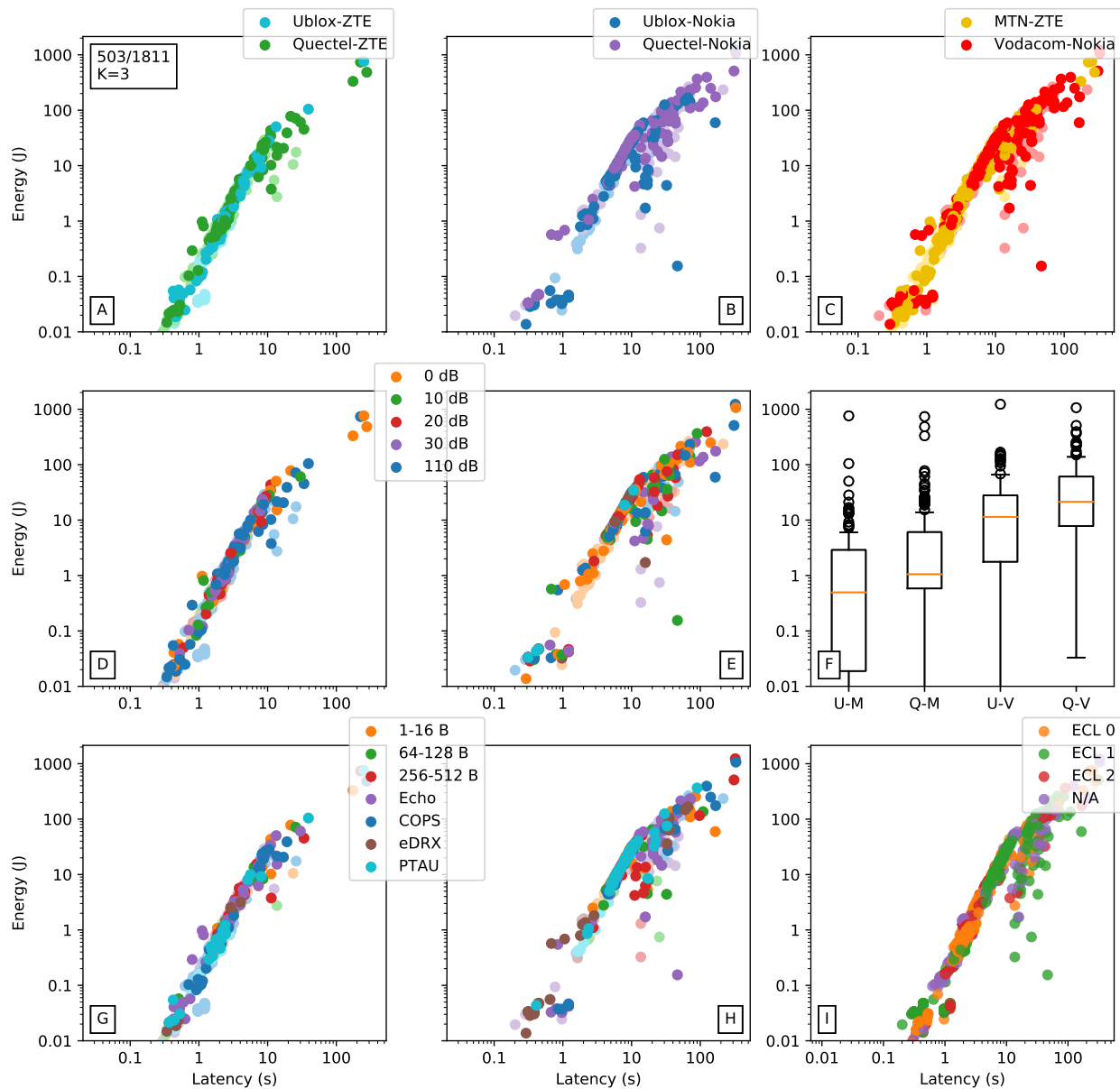


Figure C.9: Energy versus latency packets (503/1811) in comparison (AB) of UE, (C) MNOs, (DE) attenuation zones, (F) UE-MNO boxplots, (GH) test types, (I) and ECLs against RSRP for ZTE, Nokia.

In Figure C.9, attenuation zones show variation. UE-MNO pairings show similar trends, yet is possible (more in Vodacom’s case) for latency to increase and energy levels to remain the same. Telemetry tests do show variation, and with increased ECL it indicates higher latency and energy consumption. After 5 seconds, UEs consume 1 Joule per second when connected to a tower and after 15 seconds 3 Joules per second at most. However, it is possible to use energy more efficiently and increase latency. Outliers do exist from 25 seconds onwards, and it follows the same structure as the above. The majority of outliers are Vodacom-Nokia’s.

It is evident that on all attenuation levels there is a high degree of variation in latency and energy, and thus correlation with attenuation is unlikely. Considering the discrepancy between MTN and Vodacom is up to a ten-fold difference, the latter’s Nokia towers are vastly inefficient. Lastly, most of the test data falls within the first 10 seconds, with eDRX power saving being the most efficient, and network registration or sending large UDP packets being the least.

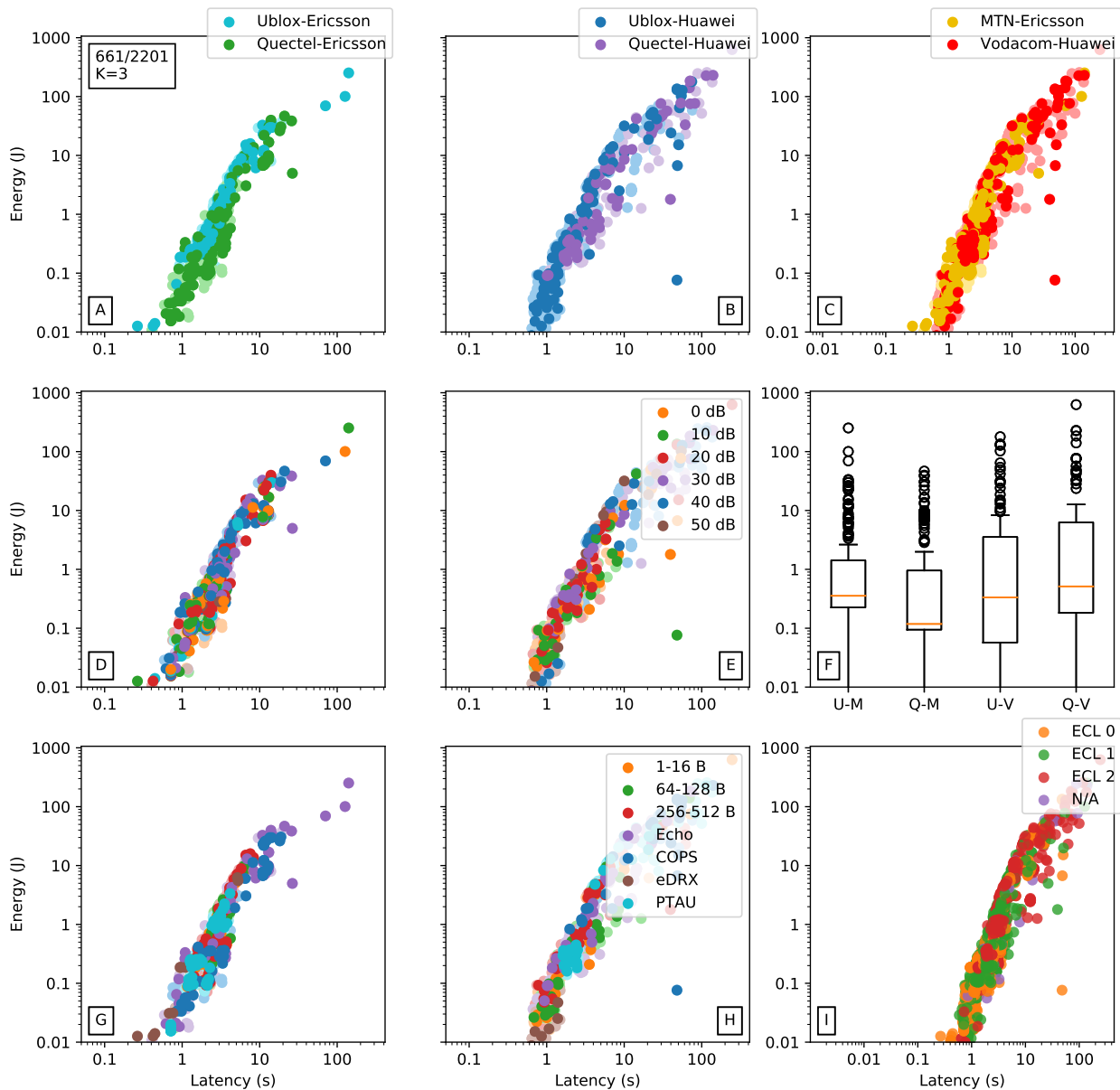


Figure C.10: Energy versus latency packets (661/2201) in comparison (AB) of UE, (C) MNOs, (DE) attenuation zones, (F) UE-MNO boxplots, (GH) test types, (I) and ECLs against RSRP for Ericsson, Huawei.

These plots show the importance of low latency communications.

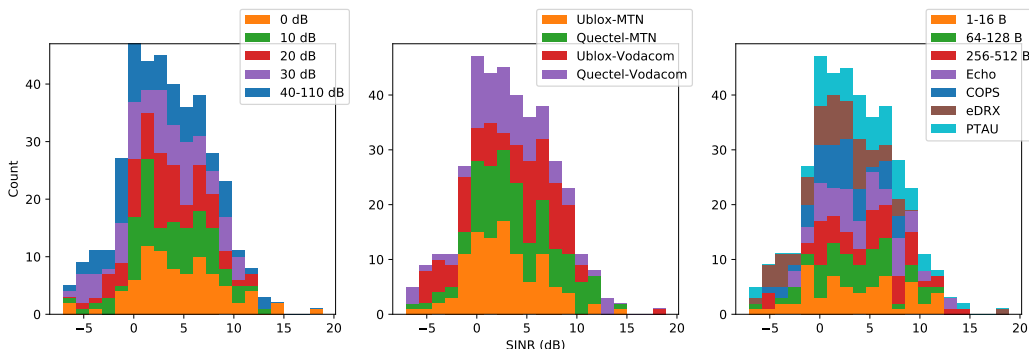


Figure C.11: Histogram distribution of SINR.

### C.3 Secondary Metrics

#### C.3.1 Signal Strength

##### C.3.1.1 SINR

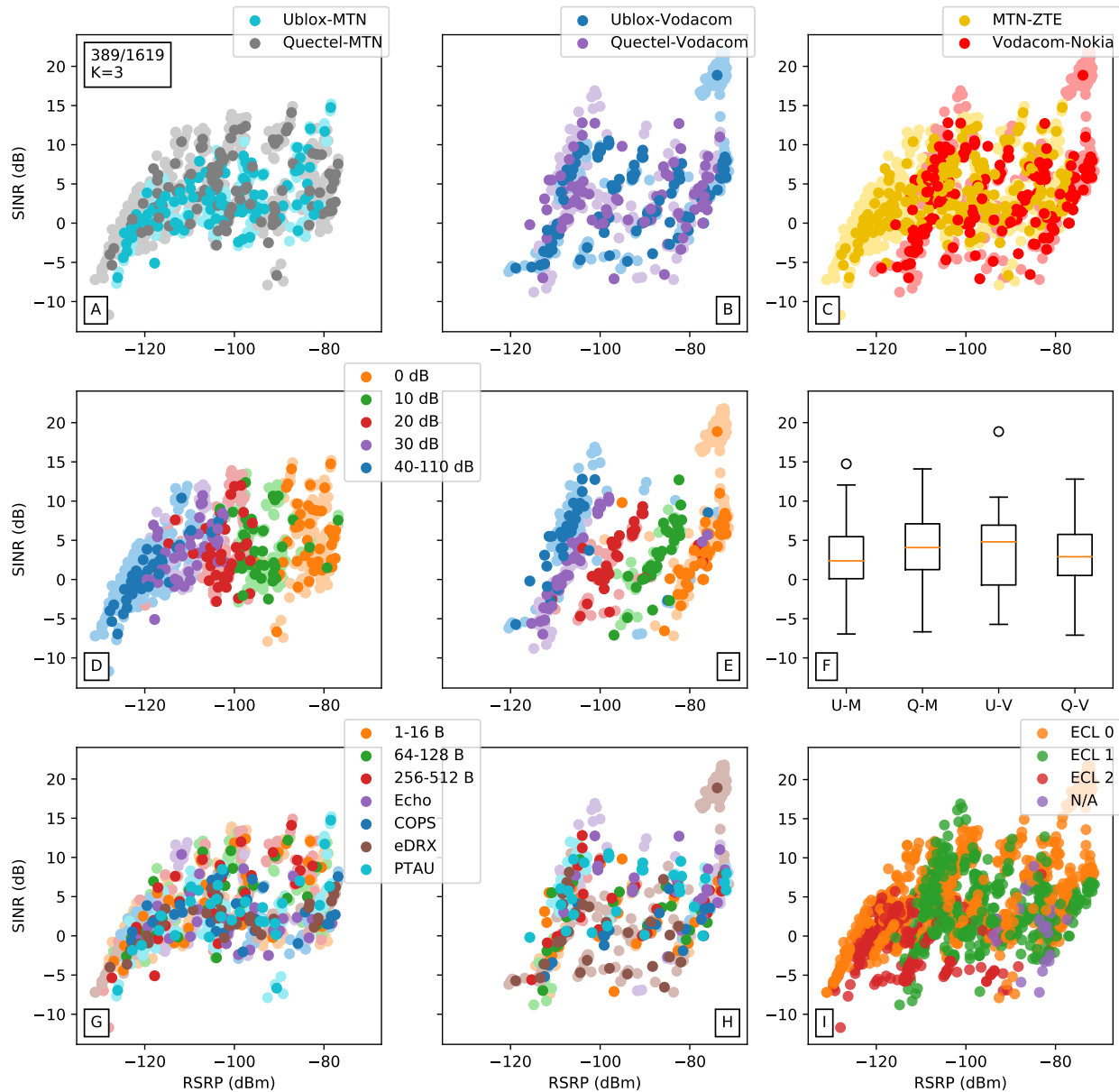


Figure C.12: SINR versus RSRP packets (389/1619) in comparison (AB) of UE, (C) MNOs, (DE) attenuation zones, (F) UE-MNO boxplots, (GH) test types, (I) and ECLs.

In Figure C.12, attenuation zones evident in RSRP and skewed by SINR axis. Vodacom shows poorer SINR than MTN. Significant variation in telemetry tests and ECL classes across both axes. SNR is spread relatively evenly for the different attenuation zones.

C.3.1.2 Transmit Power

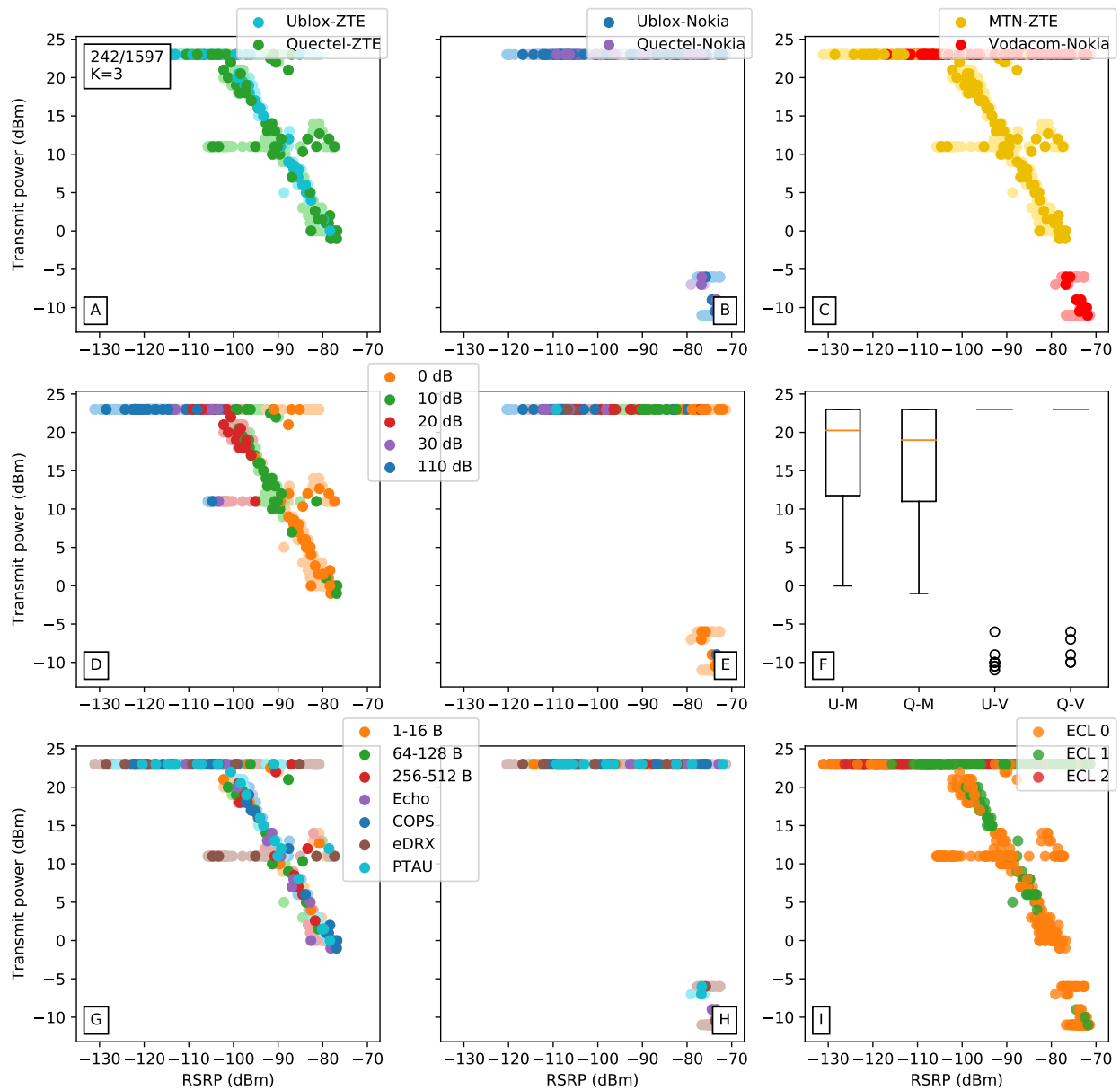


Figure C.13: Transmit powers of packets (204/1597) from -10 to 23 dBm in comparison (AB) of UE, (C) MNOs, (DE) attenuation zones, (F) UE-MNO boxplots, (GH) test types, (I) and ECLs against RSRP for ZTE, Nokia.

Transmit power decreases proportional to RSRP from around -100 dBm and stronger. Attenuation/RSRP affects transmit power on MTN, and Vodacom remains at the 23 dBm max. There is variation in all telemetry tests, and ECL class 0 and 1 uses less power but ECL class 2 remains at max power. The UE maintains a max output power of 23 dBm when connected to Vodacom towers, and decreases proportional to RSRP/RSSI on MTN towers. When comparing energy and latency to transmit power, both show variation at 23 dBm and decrease at lower powers which indicates that although it is a contributing factor it is definitely more affected by time on air. Around -100 dBm devices decrease their output power at roughly 10 dBm per decade of RSRP amplification when connected to MTN towers. This might be attributable to the ECL classes that the eNodeB sets for the UE. If the tests are repeated for RSRP signals greater than -70 dBm, it can be assumed that the transmit power will eventually decrease to -56 dBm according to the AT+UTEST command in the



Ublox N2 datasheet. If the transmit power decreases linearly according to RSRP, minimum output power would be achieved at -20 dBm or greater.

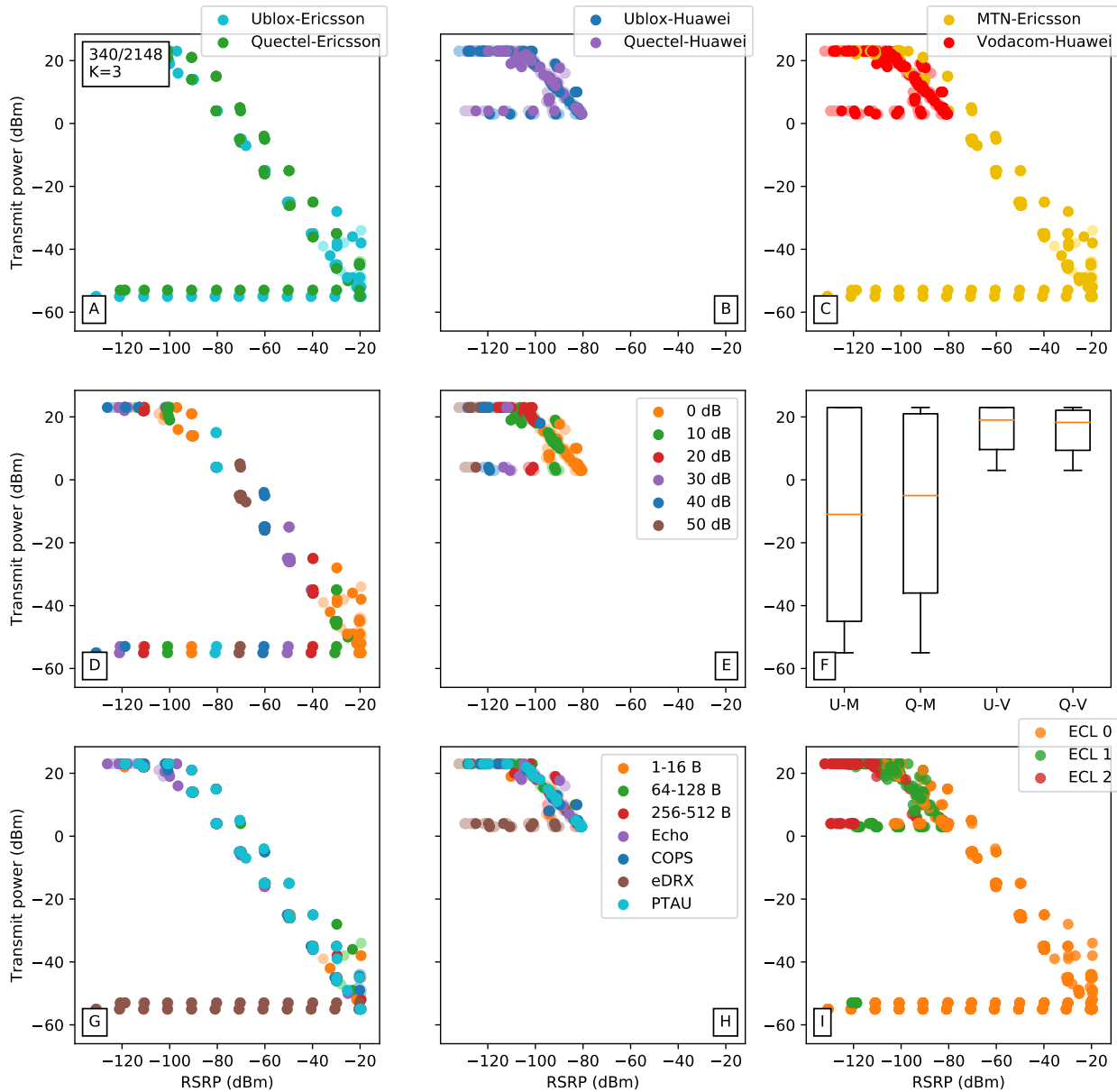


Figure C.14: Transmit powers of packets (340/2148) from -60 to 23 dBm in comparison (AB) of UE, (C) MNOs, (DE) attenuation zones, (F) UE-MNO boxplots, (GH) test types, (I) and ECLs against RSRP Ericsson, Huawei.

C.3.2 Throughput

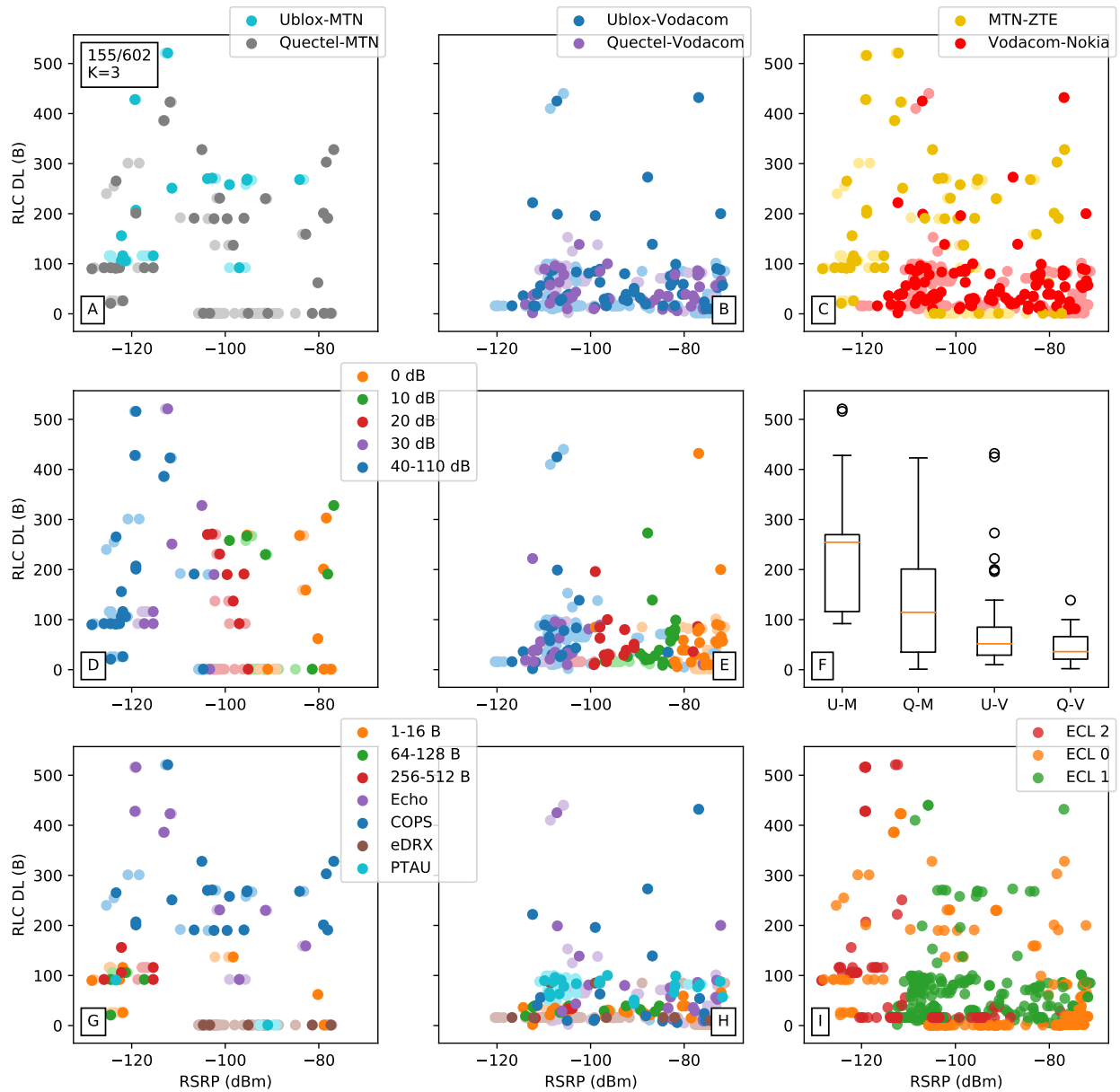


Figure C.15: RLC DL throughput of packets (155/602) in comparison (AB) of UE, (C) MNOs, (DE) attenuation zones, (F) UE-MNO boxplots, (GH) test types, (I) and ECLs against RSRP for ZTE, Nokia.

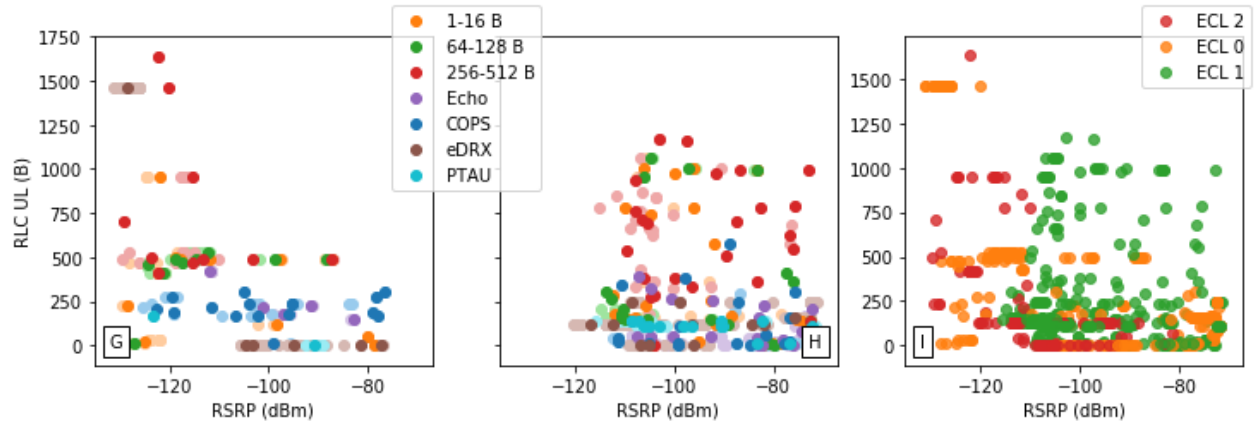


Figure C.16: Snippet of RLC UL throughput

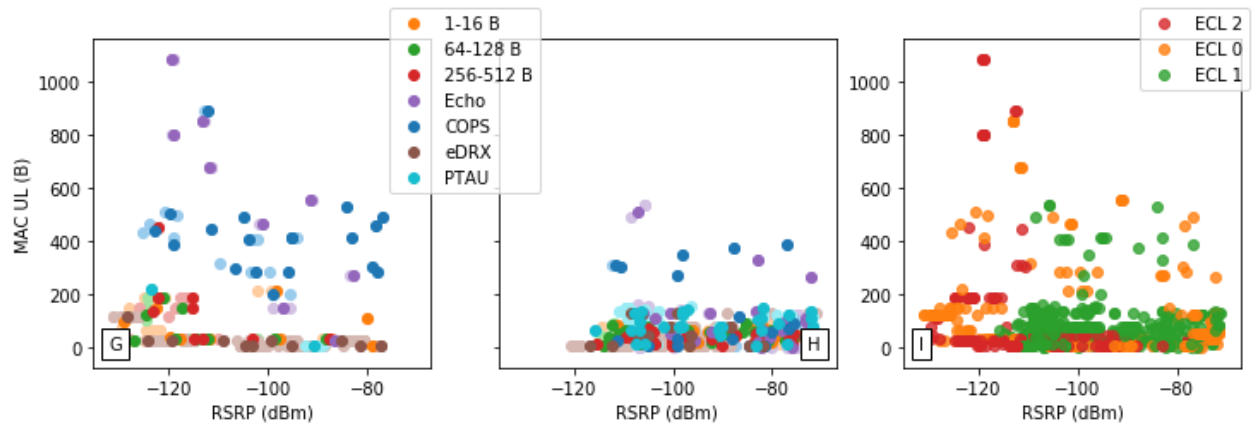


Figure C.17: Snippet of MAC DL throughput

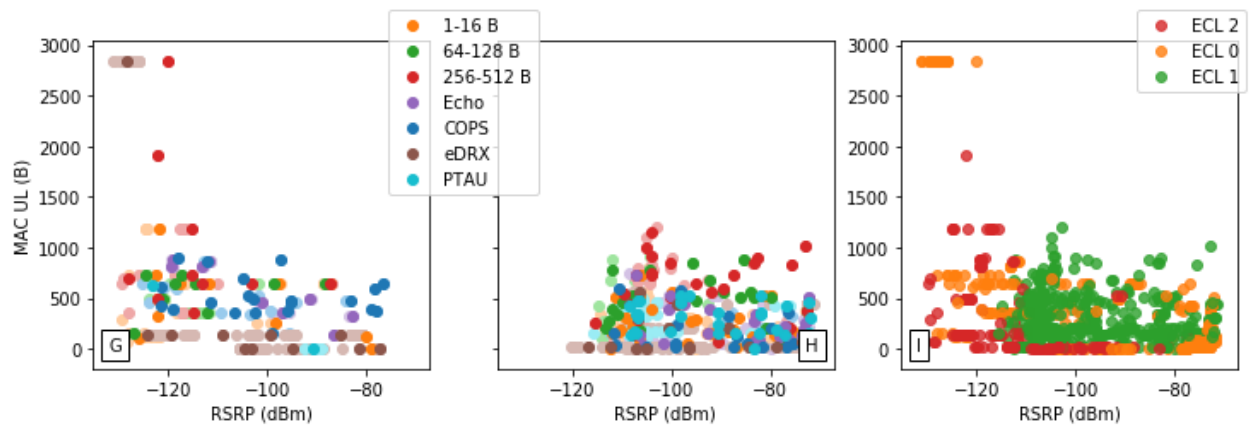


Figure C.18: Snippet of MAC UL throughput

C.3.3 Data Overhead

C.3.3.1 TX, RX bytes

It displays the BLER and total number of bytes transmitted and received by the RLC Layer and Physical Layer.

Using this statistic it is possible to see if the module is having difficulty in communicating with the base station. Even if the module is in good coverage, ECL class 0, there still might be issues causing the messages not to be sent or received.

TX bytes

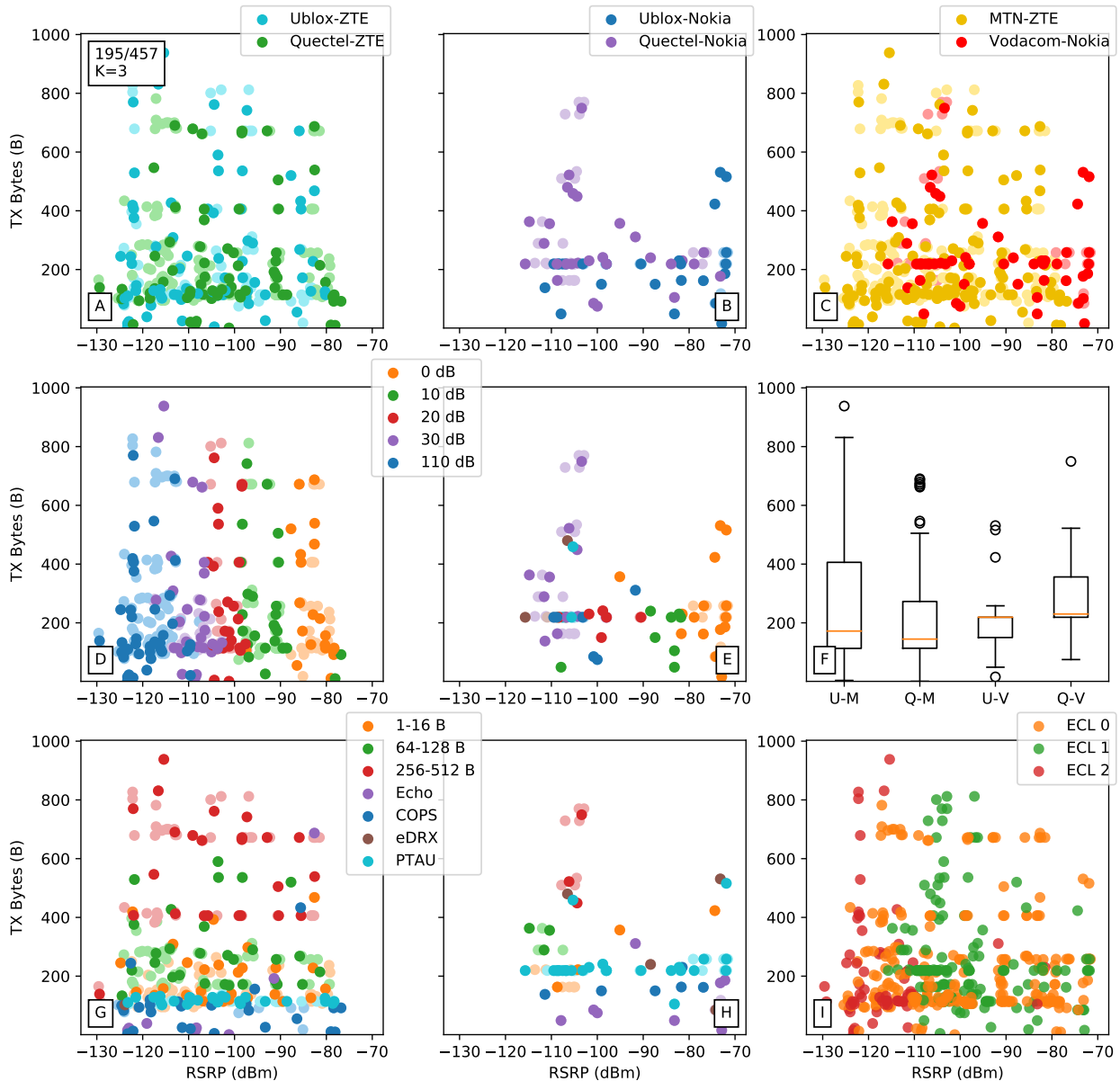


Figure C.19: TX packet sizes (174/457) up to 1kB in comparison (AB) of UE, (C) MNOs, (DE) attenuation zones, (F) UE-MNO boxplots, (GH) test types, (I) and ECLs against RSRP. Attenuation zones evident and potentially affect packet size. UE-MNO pairs share similar characteristics. Different tests are grouped with similar sizes with UDP packets being the largest, and COPS the smallest. ECL does not seem to affect packet size.

In general packets are around 100-300 bytes in size and all UE-MNO pairings share similar sizes. There are a few subtle trend lines which suggest that packet size increases proportionally to decreased RSRP. Attenuation zones do not affect packet size. Vodacom has outliers above 10kB. All outliers are as a result of UDP packet tests and ECL does not seem to affect packet size.

There is a large degree of variation in packet sizes expected to be up to 512 bytes, with sizes up to 10kB or more recorded. That's a 20-fold difference which certainly means one can run out of budget on data costs sooner than expected. The prices of packet-switched data in South Africa is high due to ICASA regulations and is the cause of much competition for remaining spectrum when most is still being used for analogue television broadcast by the SABC.

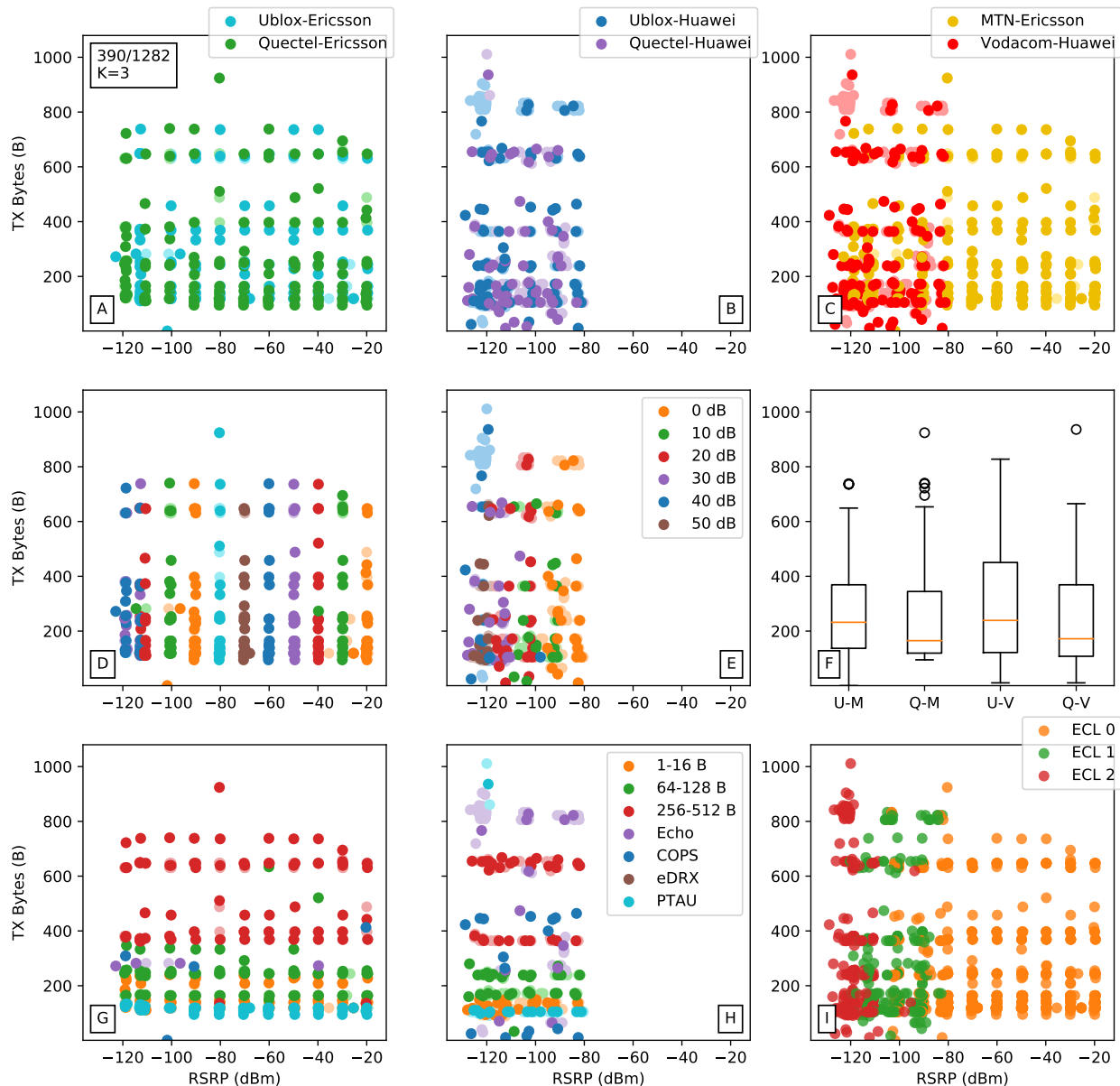


Figure C.20: TX packet sizes (390/1282) up to 1kB in comparison (AB) of UE, (C) MNOS, (DE) attenuation zones, (F) UE-MNO boxplots, (GH) test types, (I) and ECLs against RSRP. Attenuation zones evident and do not affect packet size. UE-MNO pairs share similar characteristics. Different tests are grouped with similar sizes with UDP packets being the largest, and COPS the smallest. ECL does seem to affect packet size.

RX bytes

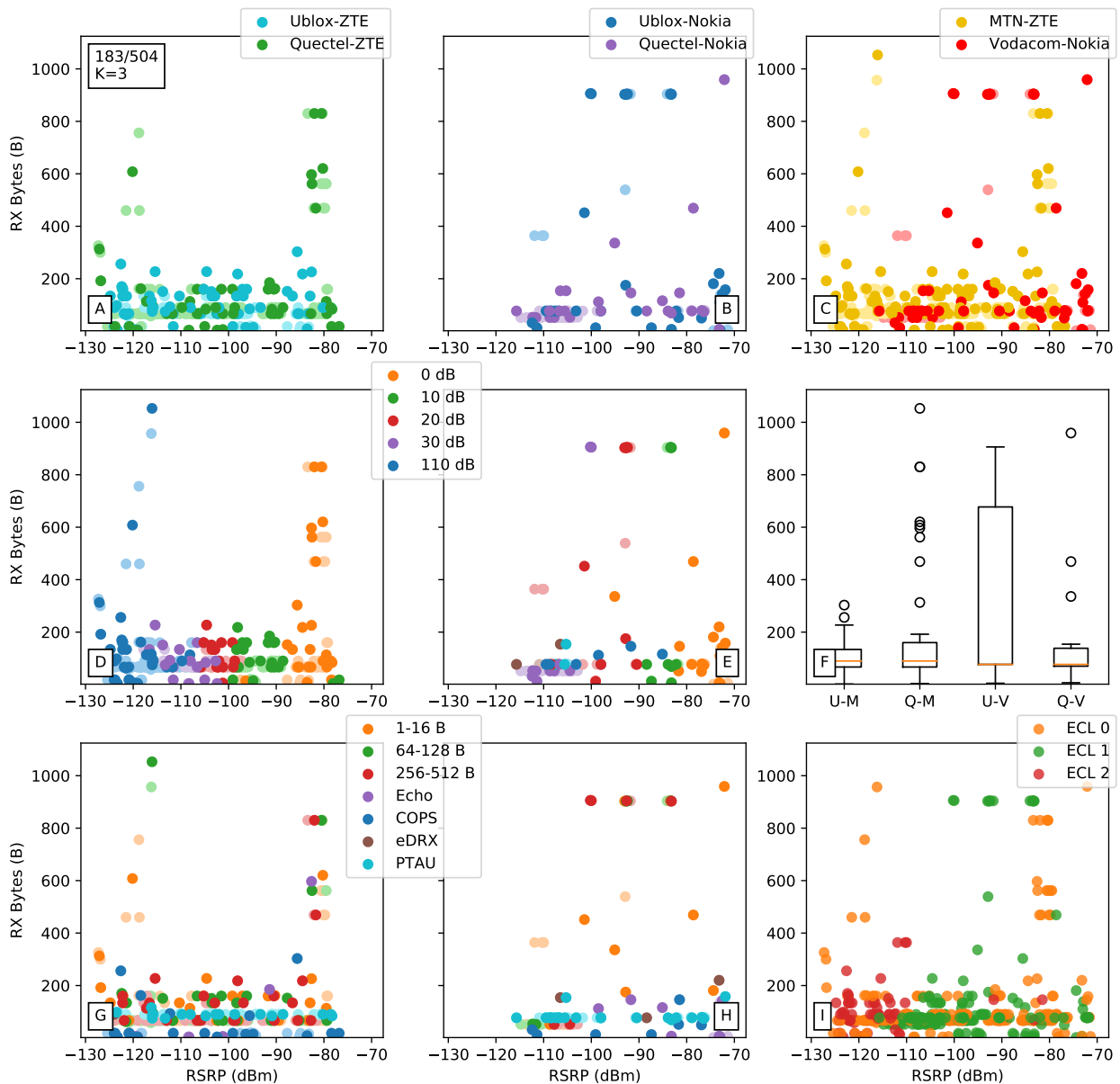


Figure C.21: RX packet sizes (166/504) up to 1kB in comparison (AB) of UE, (C) MNOs, (DE) attenuation zones, (F) UE-MNO boxplots, (GH) test types, (I) and ECLs against RSRP. Attenuation zones evident and do not affect packet size. UE-MNO pairs share similar characteristics. Different tests are grouped with similar sizes with UDP packets being the largest, and COPS the smallest. ECL does not seem to affect packet size.

In general packet sizes are up to 200 bytes. Attenuation zones do not affect packet size Quectel-MTN and Ublox-Vodacom pairs are essentially the only outliers above 300 bytes already. All outliers are as a result of UDP packet tests and ECL does not seem to affect packet size.

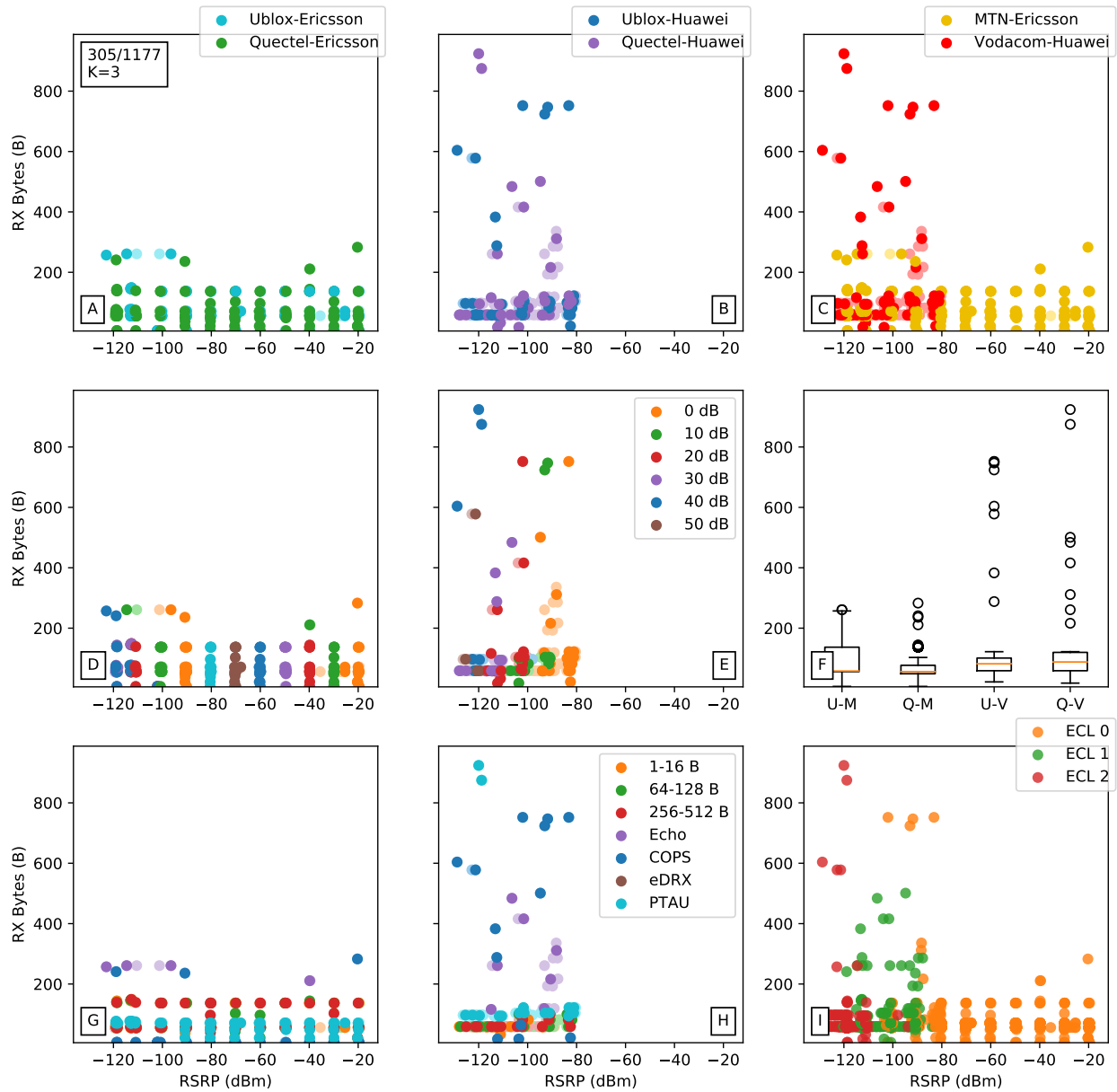


Figure C.22: RX packet sizes (305/1177) up to 200 bytes on average in comparison (AB) of UE, (C) MNOs, (DE) attenuation zones, (F) UE-MNO boxplots, (GH) test types, (I) and ECLs against RSRP. Attenuation zones evident and do not affect packet size. UE-MNO pairs share similar characteristics. Different tests are grouped with similar sizes with Echo, COPS and PTAU packets being the largest, and UDP the smallest. ECL does seem to affect packet size.

C.3.3.2 ACK to NACK Ratio

Check the Ack/Nak ratio to see a general view of the link quality.

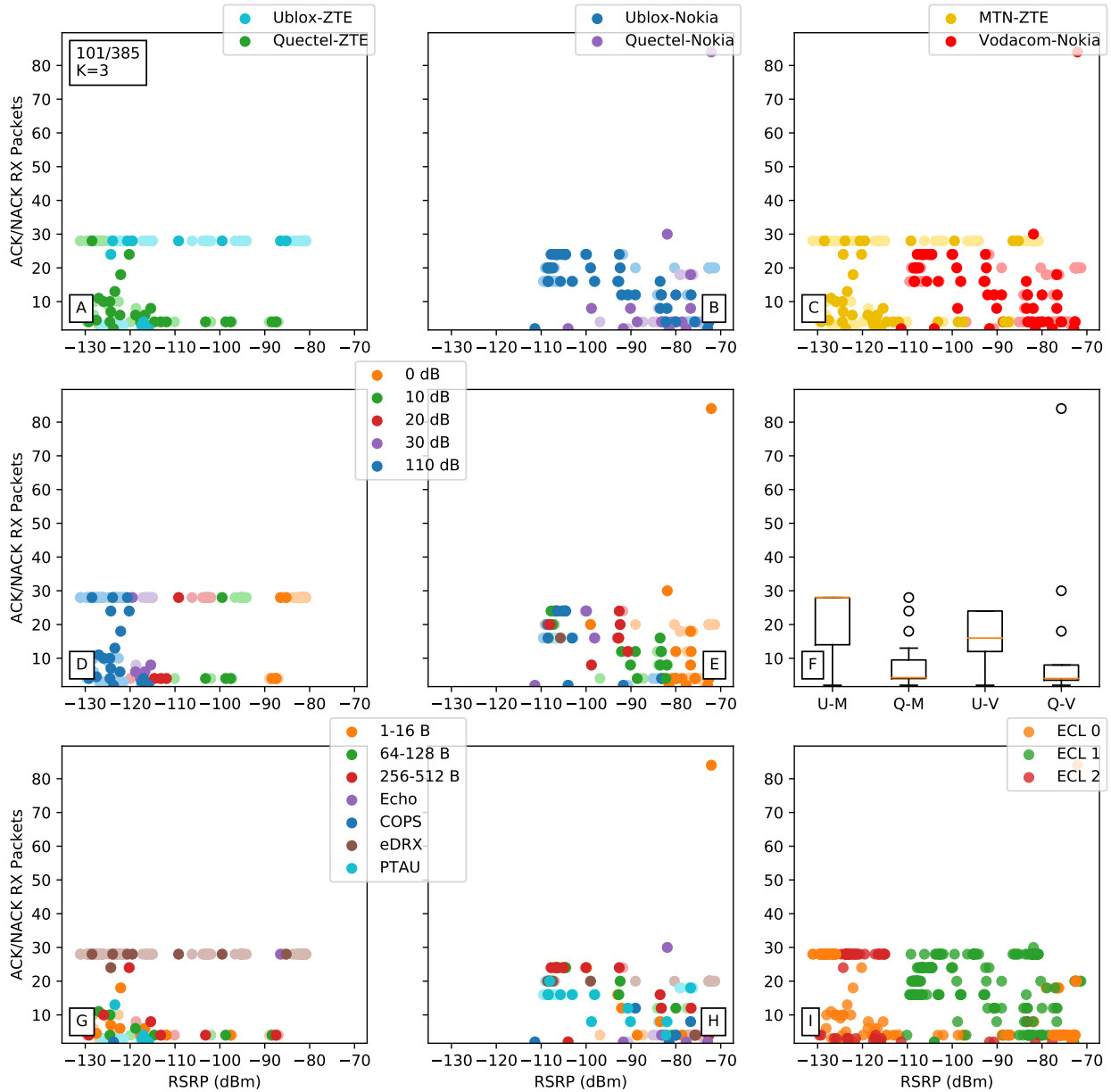


Figure C.23: ACK/NACK packets count (83/385), outlier at 80 in comparison (AB) of UE, (C) MNOs, (DE) attenuation zones, (F) UE-MNO boxplots, (GH) test types, (I) and ECLs against RSRP. Attenuation zones evident and do not affect number of ACK/NACKs. Vodacom requires more ACK/NACK responses than MTN. They share similar characteristics at a difference of 40dBm RSRP. Significant variation in tests, although eDRX tests show the greatest number. ECL does not seem to affect ACK/NACK count



D EXAMPLE APPLICATION BOARD AND SCHEMATIC

D Example Application Board and Schematic

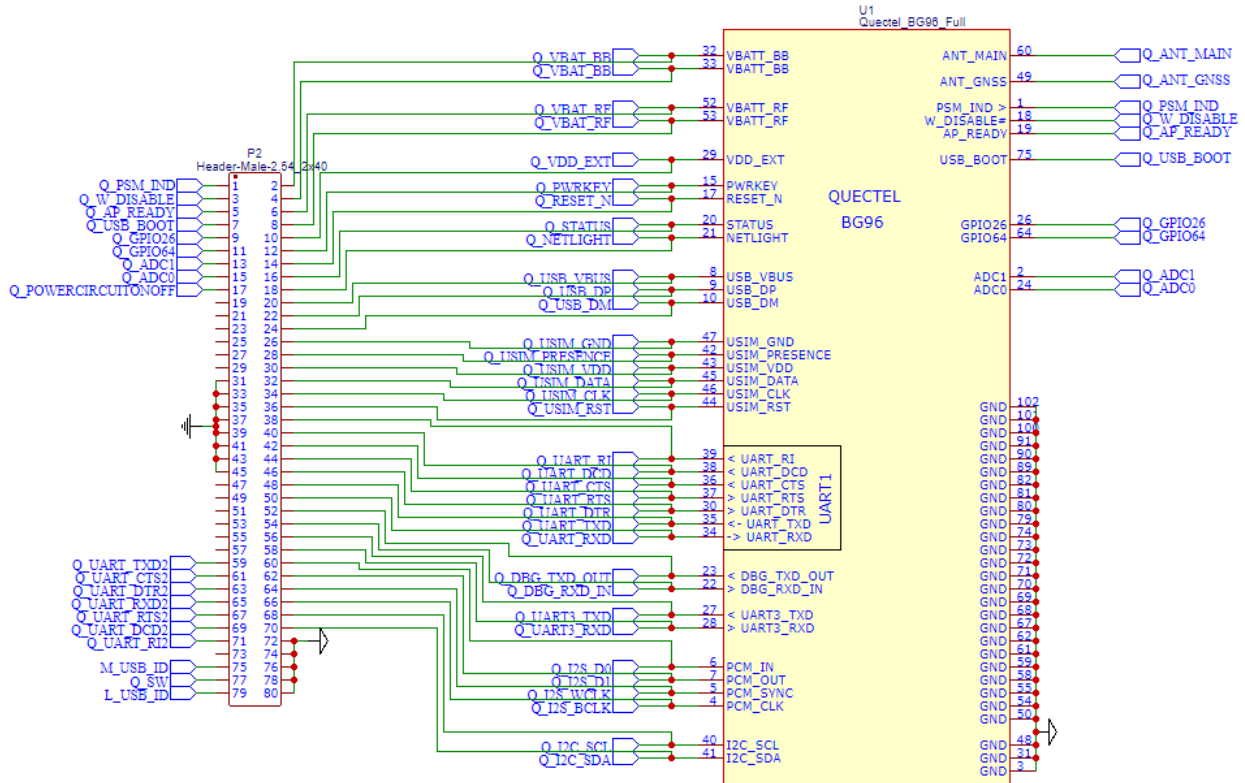


Figure D.1: Quectel BG96 modem schematic

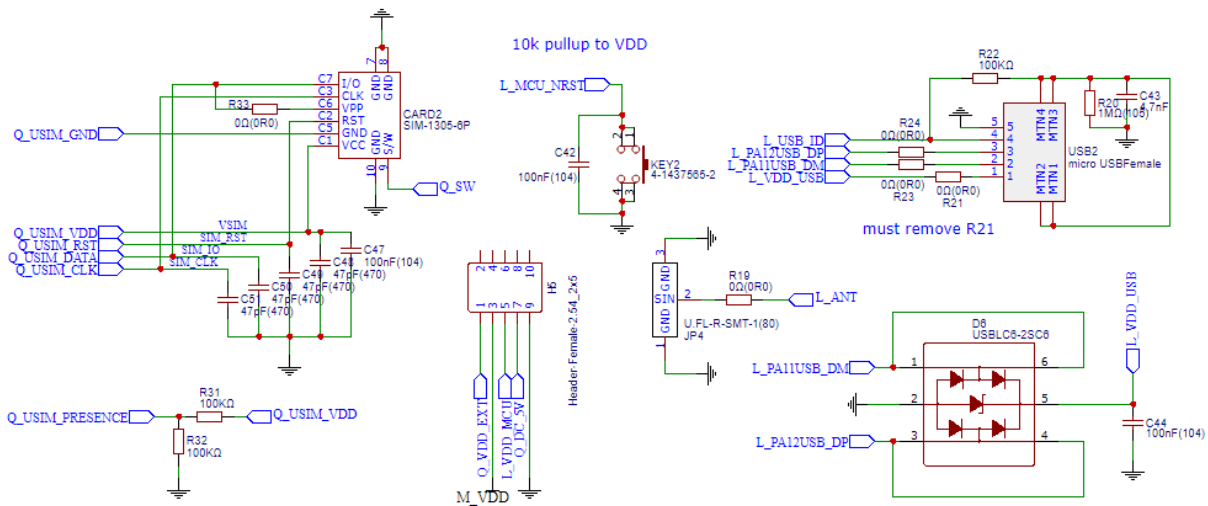


Figure D.2: SIM card, USB and miscellaneous circuitry schematic

## D EXAMPLE APPLICATION BOARD AND SCHEMATIC

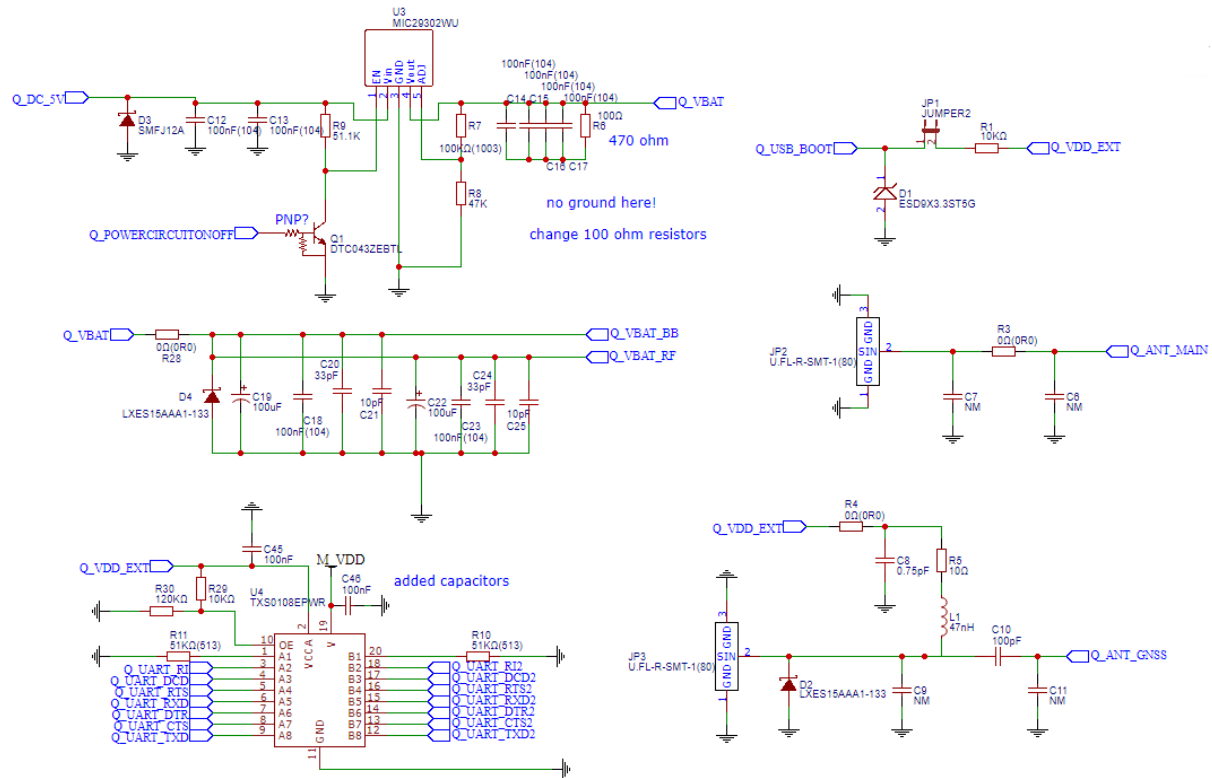


Figure D.3: Power circuitry, antenna and logic level conversion

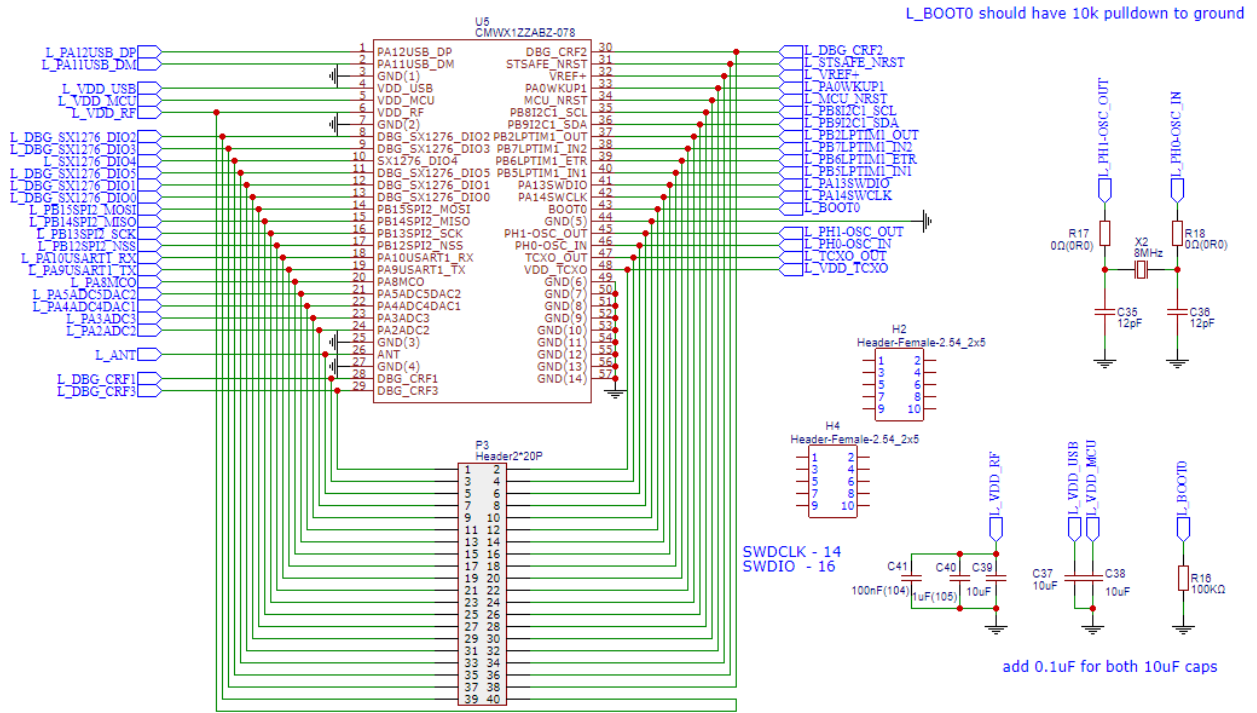


Figure D.4: Murata CMWX1ZZABZ-078 module schematic

## D EXAMPLE APPLICATION BOARD AND SCHEMATIC

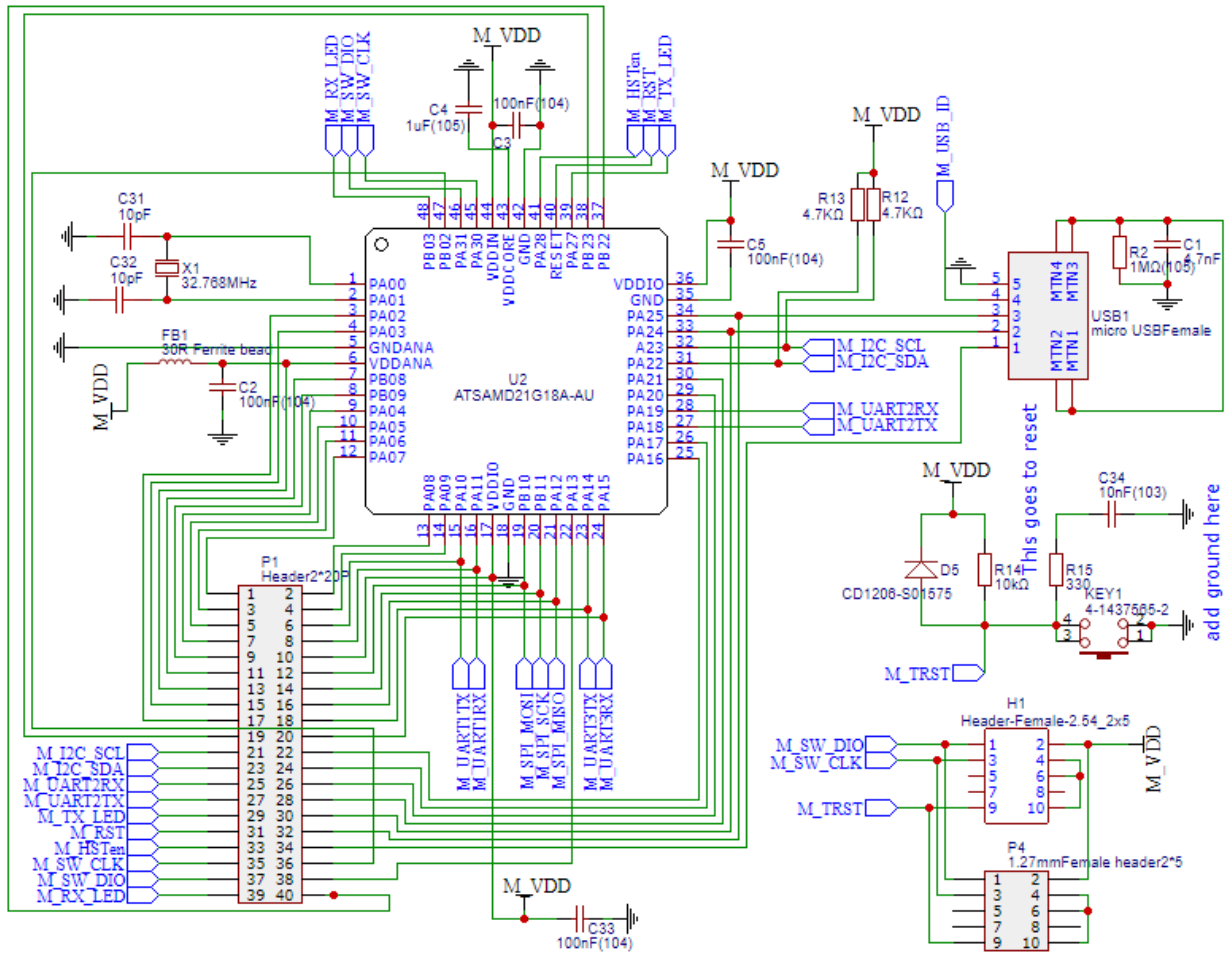


Figure D.5: Atmel ATSAMD21G18a microcontroller schematic

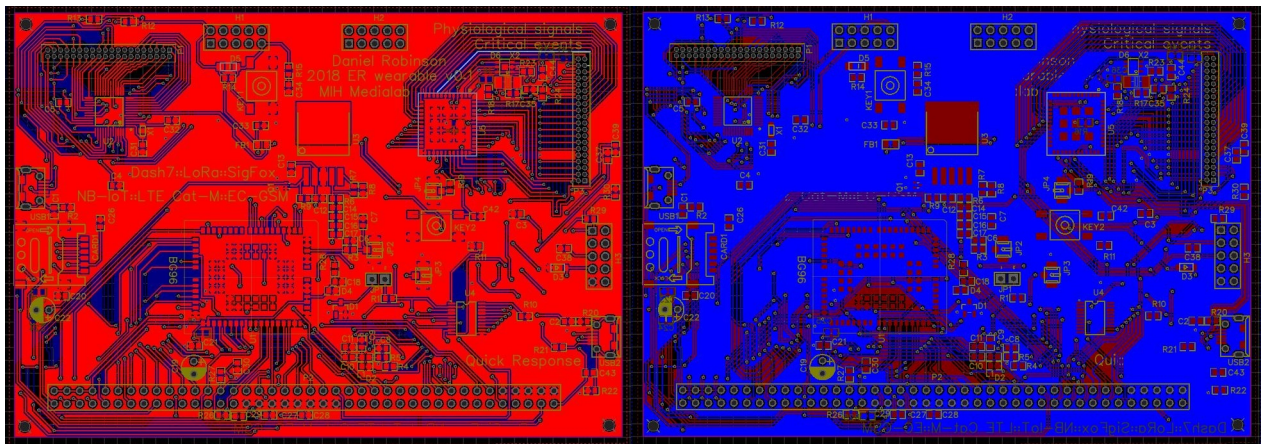


Figure D.6: Top and bottom layout of example PCB

## E SYSTEM INFORMATION BLOCK (SIB) EXAMPLES

---

### E System Information Block (SIB) Examples

These are examples of some of the information accessible in UEMonitor of SIB blocks and RRC signalling communications.

```
RRC_DEBUG_ASN
header.message_id=190840832
header.src=LAYER_RRC
header.dest=LAYER_RRC
header.length=8
len=5
channel_type=RRC_ASN_BCCH_BCH_Message_NB_PDU
data=44
Additional Info=BCCH-BCH-Message-NB:
{
  message
  {
    systemFrameNumber-MSB-r13 '0010'B,
    hyperSFN-LSB-r13 '11'B,
    schedulingInfoSIB1-r13 2,
    systemInfoValueTag-r13 19,
    ab-Enabled-r13 FALSE,
    operationModeInfo-r13 standalone-r13 :
    {
      spare '00000'B
    },
    spare '00000000 000'B
  }
}
```

```
RRC_DEBUG_ASN
header.message_id=190840832
header.src=LAYER_RRC
header.dest=LAYER_RRC
header.length=29
len=26
channel_type=RRC_ASN_BCCH_DL_SCH_Message_NB_PDU
data=64
Additional Info=BCCH-DL-SCH-Message-NB:
{
  message c1 : systemInformationBlockType1-r13 :
  {
    hyperSFN-MSB-r13 '00110001'B,
    cellAccessRelatedInfo-r13
    {
      plmn-IdentityList-r13
      {
        {
          plmn-Identity-r13
          {
            mcc
            {
              6,
              5,
              5
            },
          },
        }
      }
    }
  }
}
```

## E SYSTEM INFORMATION BLOCK (SIB) EXAMPLES

```

        mnc
        {
            0,
            1
        }
    },
    cellReservedForOperatorUse-r13 notReserved
}
},
trackingAreaCode-r13 '10011100 01000000'B,
cellIdentity-r13 '00000000 00000000 00000000 0000'B,
cellBarred-r13 notBarred,
intraFreqReselection-r13 allowed
},
cellSelectionInfo-r13
{
    q-RxLevMin-r13 -60,
    q-QualMin-r13 -23
},
freqBandIndicator-r13 8,
schedulingInfoList-r13
{
    {
        si-Periodicity-r13 rf512,
        si-RepetitionPattern-r13 every4thRF,
        sib-MappingInfo-r13
        {
        },
        si-TB-r13 b256
    },
    {
        si-Periodicity-r13 rf2048,
        si-RepetitionPattern-r13 every4thRF,
        sib-MappingInfo-r13
        {
            sibType3-NB-r13
        },
        si-TB-r13 b56
    }
},
si-WindowLength-r13 ms960,
systemInfoValueTagList-r13
{
    2,
    2
}
}
}

RRC_DEBUG_ASN
header.message_id=190840832
header.src=LAYER_RRC
header.dest=LAYER_RRC
header.length=35
len=32
channel_type=RRC_ASN_BCCH_DL_SCH_Message_NB_PDU

```

## E SYSTEM INFORMATION BLOCK (SIB) EXAMPLES

```

data=0
Additional Info=BCCH-DL-SCH-Message-NB:
{
  message c1 : systemInformation-r13 :
  {
    criticalExtensions systemInformation-r13 :
    {
      sib-TypeAndInfo-r13
      {
        sib2-r13 :
        {
          radioResourceConfigCommon-r13
          {
            rach-ConfigCommon-r13
            {
              preambleTransMax-CE-r13 n10,
              powerRampingParameters-r13
              {
                powerRampingStep dB2,
                preambleInitialReceivedTargetPower dBm-104
              },
              rach-InfoList-r13
              {
                {
                  ra-ResponseWindowSize-r13 pp5,
                  mac-ContentionResolutionTimer-r13 pp8
                },
                {
                  ra-ResponseWindowSize-r13 pp5,
                  mac-ContentionResolutionTimer-r13 pp8
                },
                {
                  ra-ResponseWindowSize-r13 pp5,
                  mac-ContentionResolutionTimer-r13 pp8
                }
              }
            },
            bcch-Config-r13
            {
              modificationPeriodCoeff-r13 n32
            },
            pcch-Config-r13
            {
              defaultPagingCycle-r13 rf256,
              nB-r13 one64thT,
              npdcch-NumRepetitionPaging-r13 r32
            },
            nprach-Config-r13
            {
              nprach-CP-Length-r13 us66dot7,
              rsrp-ThresholdsPrachInfoList-r13
              {
                31,
                21
              },
              nprach-ParametersList-r13
            }
          }
        }
      }
    }
  }
}

```

## E SYSTEM INFORMATION BLOCK (SIB) EXAMPLES

```

{
  {
    nprach-Periodicity-r13 ms640,
    nprach-StartTime-r13 ms8,
    nprach-SubcarrierOffset-r13 n36,
    nprach-NumSubcarriers-r13 n12,
    nprach-SubcarrierMSG3-RangeStart-r13 one,
    maxNumPreambleAttemptCE-r13 n4,
    numRepetitionsPerPreambleAttempt-r13 n2,
    npdcch-NumRepetitions-RA-r13 r8,
    npdcch-StartSF-CSS-RA-r13 v2,
    npdcch-Offset-RA-r13 zero
  },
  {
    nprach-Periodicity-r13 ms640,
    nprach-StartTime-r13 ms64,
    nprach-SubcarrierOffset-r13 n36,
    nprach-NumSubcarriers-r13 n12,
    nprach-SubcarrierMSG3-RangeStart-r13 one,
    maxNumPreambleAttemptCE-r13 n4,
    numRepetitionsPerPreambleAttempt-r13 n8,
    npdcch-NumRepetitions-RA-r13 r16,
    npdcch-StartSF-CSS-RA-r13 v2,
    npdcch-Offset-RA-r13 zero
  },
  {
    nprach-Periodicity-r13 ms640,
    nprach-StartTime-r13 ms128,
    nprach-SubcarrierOffset-r13 n36,
    nprach-NumSubcarriers-r13 n12,
    nprach-SubcarrierMSG3-RangeStart-r13 one,
    maxNumPreambleAttemptCE-r13 n4,
    numRepetitionsPerPreambleAttempt-r13 n32,
    npdcch-NumRepetitions-RA-r13 r32,
    npdcch-StartSF-CSS-RA-r13 v2,
    npdcch-Offset-RA-r13 zero
  }
}
},
npdsch-ConfigCommon-r13
{
  nrs-Power-r13 24
},
npusch-ConfigCommon-r13
{
  ack-NACK-NumRepetitions-Msg4-r13
  {
    r4,
    r8,
    r64
  },
  ul-ReferenceSignalsNPUSCH-r13
  {
    groupHoppingEnabled-r13 FALSE,
    groupAssignmentNPUSCH-r13 0
  }
}

```

## E SYSTEM INFORMATION BLOCK (SIB) EXAMPLES

```

    },
    uplinkPowerControlCommon-r13
    {
        p0-NominalNPUSCH-r13 -80,
        alpha-r13 a108,
        deltaPreambleMsg3-r13 4
    }
},
ue-TimersAndConstants-r13
{
    t300-r13 ms10000,
    t301-r13 ms25000,
    t310-r13 ms2000,
    n310-r13 n10,
    t311-r13 ms30000,
    n311-r13 n1
},
freqInfo-r13
{
    additionalSpectrumEmission-r13 1
},
timeAlignmentTimerCommon-r13 infinity
}
}
}
}
}
}
}
}
}
}

RRC_DEBUG_ASN
Additional Info=UL-CCCH-Message-NB:
{
    message c1 : rrcConnectionRequest-r13 :
    {
        criticalExtensions rrcConnectionRequest-r13 :
        {
            ue-Identity-r13 s-TMSI :
            {
                mmec '11110100'B,
                m-TMSI '11110101 00011001 01111010 00000011'B
            },
            establishmentCause-r13 mo-Signalling,
            spare '00000000 00000000 000000'B
        }
    }
}

Additional Info=DL-CCCH-Message-NB:
{
    message c1 : rrcConnectionSetup-r13 :
    {
        rrc-TransactionIdentifier 1,
        criticalExtensions c1 : rrcConnectionSetup-r13 :
        {
            radioResourceConfigDedicated-r13
            {
                srb-ToAddModList-r13
            }
        }
    }
}

```



E SYSTEM INFORMATION BLOCK (SIB) EXAMPLES

---

```
{
  rlc-Config-r13 explicitValue : am :
  {
    ul-AM-RLC-r13
    {
      t-PollRetransmit-r13 ms10000,
      maxRetxThreshold-r13 t32
    },
    dl-AM-RLC-r13
    {
    }
  },
  logicalChannelConfig-r13 explicitValue :
  {
    priority-r13 1,
    logicalChannelSR-Prohibit-r13 FALSE
  }
}
},
mac-MainConfig-r13 explicitValue-r13 :
{
  ul-SCH-Config-r13
  {
    retxBSR-Timer-r13 pp16
  },
  timeAlignmentTimerDedicated-r13 infinity
},
physicalConfigDedicated-r13
{
  npdcch-ConfigDedicated-r13
  {
    npdcch-NumRepetitions-r13 r8,
    npdcch-StartSF-USS-r13 v2,
    npdcch-Offset-USS-r13 zero
  },
  npusch-ConfigDedicated-r13
  {
    ack-NACK-NumRepetitions-r13 r2,
    npusch-AllSymbols-r13 TRUE,
    groupHoppingDisabled-r13 true
  },
  uplinkPowerControlDedicated-r13
  {
    p0-UE-NPUSCH-r13 0
  }
}
}
}
}
}
```

## F SIERRA WIRELESS WP7702 TEST ANOMALY

## F Sierra Wireless WP7702 Test Anomaly

This section purely shows a brief investigation into an anomaly during testing, and complex LTE can be.

From 9-20 April 2018, the Sierra Wireless WP7702 modem was tested independently at MTN's Test Plant on 14th Avenue, Johannesburg. The board is quite impressive. It boasts EC-GSM, LTE Cat M1 and NB1. It uses a Qualcomm MDM 9206 chipset, and a Yocto Linux embedded environment. Because of the Qualcomm chipset, the board (including RF packets) can be thoroughly debugged using the proprietary QXDM tool from Qualcomm via the debug port.

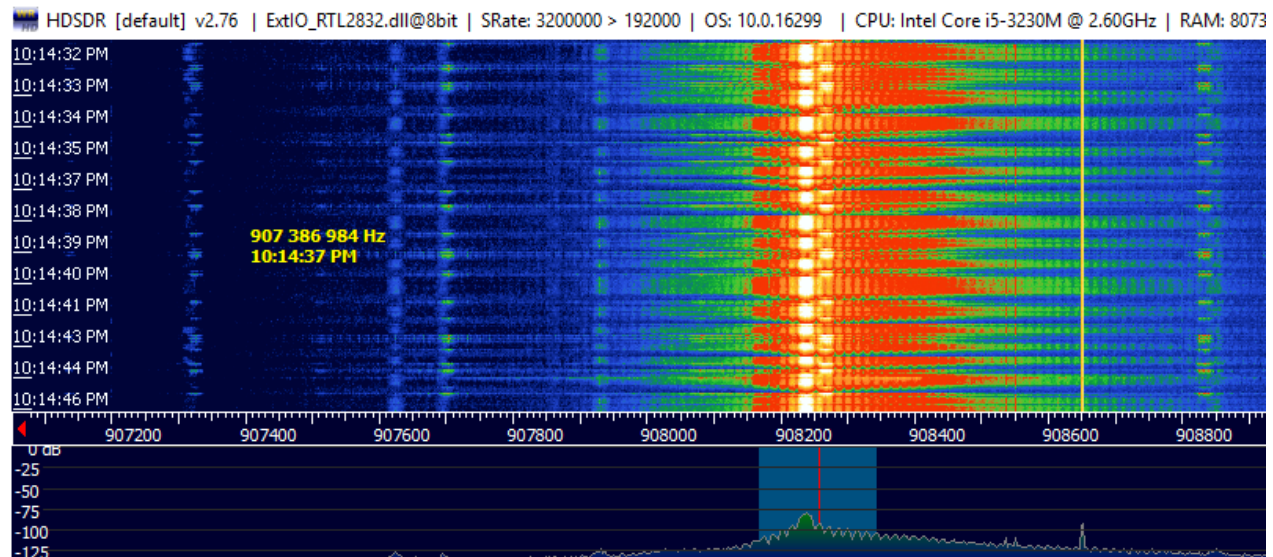


Figure F.1: Retry transmit signals for the WP7702 when extremely close to the edge of signal strength and outside the 180kHz bandwidth channel.

Although it works as in Fig. F.1, this device seems to have incomplete error handling especially when received signals are very low. On one instance, when connected to EC-GSM, it released from the network at around -90 dBm RSRP, but also threw a `+CME sim failure` error upon reattaching. Similarly it has happened a few times with NB1 and M1. If a network registration error (i.e. `+CME sim failure`) is thrown for M1 or NB1 when manually registering with `AT+COPS=1,2,"65510"`, it automatically changes the `at!selrat` from `lte only` to `gsm only`. This problem did happen with the sim card provisioned for M1 and NB1 for the test plant, but intermittently. Apparently it seems to be an issue on the Ericsson base stations. Nevertheless, it would be preferable that the board not have to be rebooted to clear the `+CME sim failure` error. Furthermore, and working around the supposed eNodeB bug, if `+CME sim failure` occurs for NB1, then one needs to register M1 first, sometimes needing to rearrange `at!selacq`. If M1 doesn't work (which also throws `+CME sim failure`, then one needs to register GSM, M1, then NB1 before NB1 finally registers. Perhaps one way to induce the problems is to reboot the Ericsson test eNB with `acc 000100 restartunit y 000`, and try to register directly with NB-IoT. It will fail, and `at!selrat` will switch to `gsm only` instead of `lte only` (even though `at!band=0` / all bands is selected). Best is also to let the device register by itself in `at+cops=0` mode. Manually has some strange side effects, like the `+CME sim failure` one, and changing the `at!selrat` to `gsm only`.

Perhaps the reason why these errors never showed up when connecting to Vodacom is due to the Idle Mode Mobility cell-selection having a certain rxLevel threshold in the SIB (System Information Block) radio packets which signal for the UE when it is advisable to switch to a tower/cell with better signal strength. This may have been confirmed by Thomas Durand who tested in Gauteng a few weeks later, and who couldn't hold a connection in Pretoria at -115dBm, and at less than -90 dBm the UE (in this case the Ublox modem mentioned later) supposedly tries to re-register with a tower stronger in strength, but GSM towers which then reject it.

G PYTEST SETUP FIXTURES

---

## G PyTest Setup Fixtures

PyTest setup fixtures for Ublox and Quectel.

```

from test_ import *

@pytest.fixture(autouse=True)
def _config(request):
    pytest.test = 'setup/'

def test_serial(request):
    pytest.subtest = request.node.name.split('_')[-1] + '/'
    import serial.tools.list_ports
    ports = serial.tools.list_ports.comports()
    for port, desc, hwid in sorted(ports):
        print("{}: {} [{}]" .format(port, desc, hwid))
        print(hwid.split('=')[1].split()[0])

@pytest.mark.setup
def test_AT(request):
    pytest.subtest = request.node.name.split('_')[-1] + '/'
    print(pytest.vendor)
    OK('AT')

@pytest.mark.setup
def test_NCONFIG(request):
    pytest.subtest = request.node.name.split('_')[-1] + '/'
    if pytest.vendor in ['ublox', 'quectel']:
        OK('AT+NCONFIG="AUTOCONNECT", "FALSE"')
        OK('AT+NCONFIG="CR_0859_SI_AVOID", "TRUE"')
        OK('AT+NCONFIG="CR_0354_0338_SCRAMBLING", "TRUE"')

@pytest.mark.setup
def test_URC(request):
    pytest.subtest = request.node.name.split('_')[-1] + '/'
    if pytest.vendor in ['ublox', 'quectel']:
        OK('AT+CMEE=1')
        OK('AT+NPSMR=1')
        OK('AT+CSCON=1')
    if pytest.vendor in ['ublox', 'simcom']:
        OK('AT+CEREG=5')
    if pytest.vendor == 'quectel':
        OK('AT+CEREG=3')
    if pytest.vendor == 'simcom':
        OK('AT+CGEREP=1')
        OK('AT+CGREG=2')
        OK('AT+CREG=2')
        OK('AT+CTZR=1')
        OK('AT+CCIOTOPT=1')
        OK('AT+CLTS=1')
        OK('AT+CSMINS=1')
        OK('AT+CPSMSTATUS=1')
        OK('ATEO')
    # todo: at+natspeed=115200,30,1

```

G PYTEST SETUP FIXTURES

---

```

@pytest.mark.apn
def test_APN(request):
    pytest.subtest = request.node.name.split('_')[-1] + '/'
    apn = 'rflab'
    # apn = 'nbiot.vodacom.za'
    if pytest.vendor in ['ublox', 'quectel']:
        OK('AT+CGDCONT=0,"IP",'' + apn + '')
    elif pytest.vendor == 'simcom':
        OK('AT*MCGDEFCONT="IP",'' + apn + '')

@pytest.mark.setup
def test_CFUN(request):
    pytest.subtest = request.node.name.split('_')[-1] + '/'
    OK('AT+CFUN=0', 3)
    receiveAT(1)
    expect('at+cfun?', '+CFUN:', 1)
    receiveAT(1)
    expect('AT+CFUN=1', '+CEREG:', 2)
    receiveAT(1)

@pytest.mark.setup
def test_COPS(request):
    pytest.subtest = request.node.name.split('_')[-1] + '/'
    if pytest.vendor in ['ublox', 'quectel']:
        receiveAT(3)
    if pytest.vendor == 'simcom':
        expect('AT+COPS=0', '+CEREG: 1', 10)
        return
    expect('AT+COPS=0', ['+CEREG: 1', '+CEREG:1'], 10)

@pytest.mark.setup
def test_CEREG(request):
    pytest.subtest = request.node.name.split('_')[-1] + '/'
    expect('AT+CEREG?', ['+CEREG: 5,1', '+CEREG:3,1'])

@pytest.mark.setup
def test_ping(request):
    pytest.subtest = request.node.name.split('_')[-1] + '/'
    if pytest.vendor in ['ublox', 'quectel']:
        expect('at+nping="8.8.8.8"', ['+NPING: "8.8.8.8"', '+NPING:8.8.8.8', '+NPINGERR:'], 20)
    if pytest.vendor == 'simcom':
        expect('AT+CIPPING="8.8.8.8"', '+CIPPING:', 20)
        receiveAT(10, '+CIPPING:')
        receiveAT(10, '+CIPPING:')
        receiveAT(10, '+CIPPING:')
    print(nuestats())
    capture(1)

@pytest.mark.reboot
def test_reboot(request):
    pytest.subtest = request.node.name.split('_')[-1] + '/'
    expect('at+nrb', '')

```

## H ERICSSON ENODEB MANAGED OBJECTS SNIPPET

## H Ericsson eNodeB Managed Objects Snippet

```

=== TPMME1 sysadm@eqm01s0fp2 ANCB ~ # get .

180420-22:33:45 10.45.254.73 18.0a MSRBS_NODE_MODEL_17.Q3_330.27706.45_27e4
  stopfile=/tmp/12068
$ssh_pid = 2914
Connected to 10.45.254.73 (SubNetwork=ONRM_ROOT_MO_R,SubNetwork=LTE_TEST,
  MeContext=B06009-TESTPLANT,ManagedElement=B06009-TESTPLANT)
=====
0                                     ManagedElement=B06009-TESTPLANT
=====
                                     SubNetwork=ONRM_ROOT_MO_R,SubNetwork=LTE_TEST,
dnPrefix                             MeContext=B06009-TESTPLANT
managedElementId                      B06009-TESTPLANT
managedElementType                    RadioNode
networkManagedElementId              B06009-TESTPLANT
release                               17.Q3
siteLocation
userLabel
=====
1                                     ENodeBFunction=1
=====
alignTtiBundWUlTrigSinr                0 (OFF)
altNasBackTo                           0 (DEFAULT_DCN)
biasThpWifiMobility                    10
caAwareMfbiIntraCellHo                 false
checkEmergencySoftLock                  false
combCellSectorSelectThreshRx            300
combCellSectorSelectThreshTx            300
csfbMeasFromIdleMode                    true
csfbUseRegisteredLai                    false
csmMinHighHitThreshold                   70
dlBbCapacityMaxLimit                    3000
dlBbCapacityNet                          300
dlMaxWaitingTimeGlobal                   0
dnsLookupOnTai                           1 (ON)
dnsLookupTimer                           0
dnsSelectionS1X2Ref                       0
dscpLabel                                 56
eNBId                                    6009
eNodeBFunctionId                          1
eNodeBPlmnId                             Struct{3}
  >>> 1.mcc = 655
  >>> 2.mnc = 10
  >>> 3.mncLength = 2
enabledUlTrigMeas                         false
eranVlanPortRef                           0
extendedWaitTimeNb                        0
forcedSiTunnelingActive                   false
gtpuErrorIndicationDscp                   40
inactivitySupervisionTimerNb               i[3] = 100 150 200
initPreschedulingEnable                    true
...

```