

Phylogeography and thermal physiology of *Meroles knoxii* (Family: Lacertidae): relevance for species responses to climate change.

by Paula Strauss

*Thesis presented in fulfilment of the requirements for the degree
of Master of Science in the Faculty of Nature Science at
Stellenbosch University*



Supervisor: Prof. Krystal A. Tolley
Co-supervisor: Prof. Susana Clusella-Trullas

December 2016

DECLARATION

By submitting this thesis electronically, I declare that the entirety of the work contained therein is my own, original work, that I am the sole author thereof (save to the extent explicitly otherwise stated), that reproduction and publication thereof by Stellenbosch University will not infringe any third party rights and that I have not previously in its entirety or in part submitted it for obtaining any qualification.

December 2016

ABSTRACT

Climate change is considered to be one of the greatest threats to species and ecosystems globally and is likely to contribute to the rapidly increasing number of species extinction. In South Africa, these climatic changes have been noted and are thought to persist. Lizards, as ectotherms, are exceptionally vulnerable to changes in their thermal environments and could face even greater extinction risk if they lack the capacity to behaviourally mediate or rapidly adapt to changing thermal environments. Species distribution models have only recently started incorporating genetic and physiological mechanistic variables to more accurately predict species responses to climate change. This study investigates genetic and physiological traits in order to elucidate genetic patterns and thermal traits that could aid in more accurately predicting the climate change responses of a southern African lacertid lizard. In Chapter 2, I investigated the phylogeographic occurrence of *Meroles knoxii* along the west coastal margin of southern Africa, with special focus on the southern mesic extent of the distribution range. Phylogeographic and population genetic analyses consistently retrieved three distinct genetic clades (north, central and south) that occur allopatrically on a north-south axis along the coastline. Body size differences occur between the northern and southern clades with the northern xeric clade displaying significantly larger body sizes than the southern mesic clade, suggesting local adaptation to these environments in conjunction with the genetic differentiation observed. The southern clade exhibited no genetic differentiation at a small spatial scale and is thus considered a single population. In Chapter 3, the thermal sensitivity of several traits of *M. knoxii* was investigated comparing two sites within the southern clade to determine whether and which traits are variable or conserved at a small spatial scale. Selected body temperatures differed significantly between sites. However, these differences are not considered biologically relevant in this study. Critical thermal limits, resting metabolic rate and total evaporative water loss did not differ significantly between sites and is considered a conserved thermal trait at this small spatial scale. In addition, the potential trade-off of thermal performance traits (sprint speed and stamina) was investigated for this ambush predator at one site, Zandvlei Nature Reserve. As expected, *M. knoxii* displayed optimal sprint speed capacity at high test temperatures and optimal stamina at lower test temperatures. This study aims to illustrate the importance of incorporating ecologically relevant mechanistic variables into species distribution models to more accurately predict species potential responses to future climate change.

OPSOMMING

Klimaatsverandering word beskou as een van die grootste bedreigings tot spesies en ekosisteme wêreldwyd en sal moontlik bydra tot 'n toenemende aantal spesie-uitsterftes. Hierdie veranderinge is aangeteken in Suid-Afrika en word beskou as voortdurend. Akkedisse, as ektoterme diere, is besonders kwesbaar tot veranderinge in hulle termiese omgewings en kan selfs 'n groter uitsterwingsrisiko in die gesig staar as hulle die vermoë ontbreek om deur gedrag aan te pas by snel-veranderende termiese omgewings. Spesieverspreidingsmodelle het eers onlangs begin om genetiese en fisiologiese meganistiese veranderlikes in te sluit om spesieresponse tot klimaatsverandering meer akkuraat te voorspel. Hierdie studie ondersoek genetiese en fisiologiese kenmerke om genetiese patrone en termiese karaktereienskappe toe te lig, wat kan bydra tot meer akkurate voorspellings van die reaksies van 'n Suid-Afrikaanse sandakkedis ten opsigte van klimaatsverandering. Hoofstuk 2 ondersoek die filogeografiese verspreiding van *Meroles knoxii* aan die weskus van suidelike Afrika, met spesifieke fokus op die suidelike nat-omgewingsomvang van die verspreidingsgebied. Filogeografiese- en bevolkingsgenetika-analise toon konsekwent drie unieke genetiese klades (noord, sentraal en suid) wat allopatries voorkom op 'n noord-suid-as langs die kuslyn. Verskille in liggaamsgroote kom voor tussen die noordelike en suidelike klades, waar die noordelike droë-omgewingsklade beduidend groter liggame toon in vergelyking met die suidelike nat-omgewingsklade. Dit dui op plaaslike aanpassing tot hierdie omgewings in samewerking met die genetiese differensiasie opgemerk. Die suidelike klade toon geen genetiese differensiasie op 'n klein ruimtelike skaal nie en word dus beskou as 'n enkele populasie. In Hoofstuk 3 word die termiese vatbaarheid van verskeie kenmerke van *M. knoxii* ondersoek. Twee studieterreine binne die suidelike klade word vergelyk om vas te stel of en watter kenmerke veranderlik of behoue is op 'n klein ruimtelike vlak. Gekose liggaamstemperature het beduidend verskille tussen studieterreine getoon, alhoewel hierdie verskille word nie as biologies relevant beskou vir hierdie studie nie. Kritiese termiese limiete, rustende metaboliese tempo en algehele waterverdampingsverlies het nie beduidend verskil tussen studieterreine nie en word beskou as 'n behoue termiese kenmerke op hierdie klein ruimtelike skaal. Voorts, is die potensiële kompromieë van die termiese werkverrigtings-vermoëns (naelloopspoed en stamina) ook ondersoek vir hierdie lokval roofdier op een van die studieterreine, Zandvlei Natuureservaat. Soos verwag, toon *M. knoxii* optimale naelloopspoedkapasiteit by hoë toetstemperature en optimale stamina by laer toets temperature. Hierdie studie poog om te wys dat die insluiting van ekologies-relevante meganistiese veranderlikes in spesieverspreidingsmodelle belangrik is om meer akkurate voorspellings te kan maak met betrekking tot potensiële response tot toekomstige klimaatsverandering.

ACKNOWLEDGEMENTS

Firstly, I would like to thank my supervisors, Prof. Krystal Tolley and Prof. Susana Clusella-Trullas, for their unwavering support and assistance through the years. This study would not have been possible without you. I would like to thank the National Research Foundation (NRF) of South Africa and the Ministère de l'Enseignement Supérieur et de la Recherche for funding (Protea). I would also like to thank the South African National Biodiversity Institute (SANBI) for funding. Special thanks to Anthony Herrel (Paris Muséum National d'Histoire Naturelle), Bieke Vanhooydonck and John Measey (Centre of Excellence for Invasion Biology, Stellenbosch University) for assisting with analyses (AH) and the use of performance equipment. Great thanks to Gert Greeff at Koeberg Nature Reserve, Joshua Gericke and Shihabuddeen Khan at Zandvlei Nature Reserve for allowing me access to conduct fieldwork. Fieldwork and sampling assistance was graciously provided by Hanlie Engelbrecht, Ryan Daniels, Andreas Noble, Johan Mostert and Dion de Jager. Thank you to Uncle Kerneels, Aunt Gerida and Peet Fourie for providing accommodation during fieldwork on the west Cape coast. I appreciate the access to tissue samples from the Molecular Laboratory Herpetology tissue bank at SANBI, Kirstenbosch. In addition, I would like to thank the Molecular Laboratory for use of the laboratory and office facilities. Thanks to the Centre of Excellence for Invasion Biology laboratory at Stellenbosch University for use of the laboratory facilities. This work was conducted under national research permits (AAA007-00035-0035) and with ethics clearance from both SANBI (003/2011) and Stellenbosch University (SU-ACUM12-00006).

I am indebted to my colleagues at the Molecular laboratory for readily assisting me in my endeavours and creating an outstanding working environment conducive to communicating research ideas freely and delivering constructive criticism. Great thanks to Ferozah Conrad, Rowena Siebritz and Rene du Toit for administrative and human resources support and genuinely being great people to work with. I thank the IT department at SANBI for always being available to help.

I would like to thank my mother, Joan Strauss, and my sister, Linda for supporting me and believing in me when I struggled to do so. My brothers, Hennie and Abrie, for making fun of my work and thereby agreeing that they think it's cool. Tanya Strauss (Salim), thank you for just saying it's cool, unlike my brothers. Thank you to my friends that always understood: Elindi Jansen van Rensburg, Hanlie Engelbrecht, Phillip and Sue Cronje, Jan-Daniël de Villiers, Petre van Huysteen, Andre Johnson, Johan Church, Megan Schultz, Kyle Willard and Elizabeth Moll. To Andreas Noble, you have been my rock in shifting sands. Dankie Pappa, vir alles.

I am indebted to the two women who have inspired me, Krystal Tolley and Shelley Edwards. Your integrity, conviction, curiosity and passion has made a lasting impression on me, one I hope to aspire to indefinitely.

TABLE OF CONTENTS

DECLARATION	i
ABSTRACT	ii
OPSOMMING	iii
ACKNOWLEDGEMENTS.....	iv
TABLE OF CONTENTS	v
LIST OF FIGURES.....	vii
LIST OF TABLES.....	x
LIST OF ABBREVIATIONS	xii
CHAPTER 1	1
1.1 GENERAL INTRODUCTION.....	1
1.2 REFERENCES.....	6
CHAPTER 2	12
Phylogeographic occurrence of <i>Meroles knoxii</i> suggests influences of historic sea level fluctuations and contemporary climatic gradients.....	12
2.1 INTRODUCTION.....	13
2.2 METHODS.....	18
2.2.1 Fieldwork/Sampling	18
2.2.2 DNA Extraction, Amplification and Sequencing.....	19
2.2.3 Phylogenetic Analysis.....	20
2.2.4 Population genetics	21
2.2.5 Morphology (body size)	22
2.3 RESULTS	22
2.3.1 Phylogenetic Analyses	22
2.3.2 Population genetics	23
2.3.3 Morphology (body size)	24
2.4 DISCUSSION	29
2.5 REFERENCES:.....	33
CHAPTER 3	44
Thermal traits of two sites identify potential mechanistic traits for species distribution modelling of <i>Meroles knoxii</i> 's southern distribution range.....	44
3.1 INTRODUCTION.....	45
3.2 METHODS.....	49
Fieldwork, lizard maintenance and laboratory set-up.....	49

3.2.1 Selected body temperature (T_{sel})	49
3.2.2 Critical thermal limits (CTL's)	51
3.2.3 Performance traits	52
3.2.4 Resting metabolic rate (RMR) and total evaporative water loss (TEWL).....	53
3.3 STATISTICAL ANALYSES	54
3.3.1 Selected body temperature (T_{sel})	54
3.3.2 Critical thermal limits (CTL's)	54
3.3.3 Performance	55
3.3.4 Resting metabolic rate (RMR) and total evaporative water loss (TEWL).....	55
3.4 RESULTS	56
3.4.1 Selected body temperature (T_{sel})	56
3.4.2 Critical thermal limits (CTL's)	58
3.4.3 Performance	59
3.4.4 Resting metabolic rate (RMR) and total evaporative water loss (TEWL).....	60
3.5 DISCUSSION	64
3.6 REFERENCES.....	66
GENERAL CONCLUSION	72
APPENDICES.....	73

LIST OF FIGURES

Figure 1.1: Current and potential future distribution of South African biomes. These maps and predictions have been adopted from Rutherford and colleagues (1999). White areas indicate future unknown biomes and climates.

Figure 1.2: Point locality records (black dots) of *Meroles knoxii* (insert) occurring along the west coast of southern Africa. Succulent Karoo and Fynbos Biomes are indicated in brown and green, respectively. Winter-rainfall zone (WRZ) occurs west of the dotted line. Temperature and rainfall gradients occur in opposite directions on north-south axes along the coastline.

Figure 2.1: Point localities records (black) of *Meroles knoxii* (insert) along the west coastal margin of southern Africa (map insert). Sites sampled for previous studies (yellow) and this study (blue) are shown within the distribution (Table 2.4). Greater Cape Floristic Region (GCFR, diagonal stripes) comprises the Succulent Karoo (brown) and Fynbos (green) biomes (Mucina et al., 2006). The approximate winter-rainfall zone occurs west of dotted line (Schulze, 2007, Stowe & Sealy, 2015).

Figure 2.2: Contemporary point locality records for all species of *Meroles* (excluding *M. micropholidotus*) presented on the common climate classification of Köppen-Geiger, showing species occurring in arid/warm temperate regions, with the exception of *M. knoxii* (black dots).

Figure 2.3: Phylogenetic relationship of *Meroles knoxii* compared to several southern Africa outgroup lizards (Lacertidae: Eremiadini) estimated using two mitochondrial (16S, ND4) and one nuclear (RAG1) marker. Bayesian topology used to show relationships with Bayesian inference (posterior probability ≥ 0.95) and maximum likelihood (bootstrap values $\geq 0.75\%$). Support indicated as follows: both analyses (black circles), Bayesian inference (grey circles), Maximum likelihood (white circles), unsupported nodes (no circles). Map inset: Phylogenetic analysis revealed three clades that correspond to geographically distinct groups; a northern clade (blue squares), central clade (pink dots) and southern clade (yellow triangles). Black dots indicate the point localities of *M. knoxii*. See Fig. 2.4 for details.

Figure 2.4: Geographic distribution of the three clades of *Meroles knoxii* (inset) identified by phylogenetic inference (Fig. 2.3). Relevant sites are indicated on the map, with the northern clade (blue squares) occurring predominantly in the Succulent Karoo Biome (brown) and the central (pink dots) and southern (yellow triangles) clades occurring in the Fynbos Biome (green). Chevrons indicate the Knersvlakte. Black dots indicate occurrence records of *M. knoxii*.

Figure 2.5: Haplotype networks of 16S (left) and ND4 (right) revealed 14 (n=82) and 43 (n=95) haplotypes for each marker, respectively. Circles show each haplotype, with the size of the circle indicating the frequency, and these are colour coded to show which haplotypes occur in the

northern clade (blue), central clade (pink) and southern clade (yellow). A 95% connection limit did not group clades separately for 16S, but did group clades separately for ND4, including ND4 haplotypes from Port Nolloth (northern clade) and Draaihoek (southern clade). The black dots on the haplotype connections indicate number of mutations between those haplotypes.

Figure 2.6: a) SAMOVA results indicate three genetic groups which reflect the clades identified by the phylogenetic analyses; northern, central and southern. Among group variation plateaus for combined mtDNA and separately analysed 16S and ND4 analyses at $K=3$. b) SAMOVA analyses show no among group variation in southern clade for combined mtDNA data, or separately analysed 16S and ND4 analyses, indicating a lack of genetic structure within this group of sampled data.

Figure 2.7: Mantel test indicates a significant positive correlation between geographic distance (x-axis; kilometers) and genetic distance (y-axis; F_{ST} ; $p < 0.01$) for the combined mtDNA data (diamonds) and separately analysed 16S (squares) and ND4 (triangles) data.

Figure 2.8: Mean snout-vent-length (millimetres) of northern and southern clades showing northern clade individuals ($n=30$) have a significantly larger body size than southern clade ($n=105$) individuals. Mean indicated as horizontal lines in boxes, boxes indicate variance around the mean, error bars \pm s.e.m., northern clade data shows two outliers (circles).

Figure 2.9: Digital elevation model of the sea level transgression experienced during the late Pliocene (90m MSL). The northern clade (blue) and central clade (pink) are bisected by the Olifants River, whilst the central clade and southern clade (yellow) are bisected by the Berg River to an even greater extent. One exception is the Draaihoek specimen (green), which forms part of the southern clade, but groups separately in the phylogeny (Fig. 2.3).

Figure 3.1: Sampled sites at Rietvlei Nature Reserve and Zandvlei Nature Reserve from the southwestern region of Western Cape Province of South Africa.

Figure 3.2: CT_{min} of RNR ($n=16$) and ZNR ($n=9$; left) and CT_{max} of RNR ($n=16$) and ZNR ($n=9$; right). Error bars $^{\circ}C \pm$ s.e.m.

Figure 3.3: Optimal temperatures (T_{opt}) and performance breadths (T_{pb80} and T_{pb95}) of sprint speed and stamina traits of ZNR individuals.

Figure 3.4: Minimum, mean and maximum VCO_2 and VH_2O production at the three test temperature ($15^{\circ}C$, $25^{\circ}C$ and $35^{\circ}C$). RMR and TEWL increase as temperature increases, with RMR and TEWL increasing more rapidly between $25-35^{\circ}C$ than between $15-25^{\circ}C$ for mean and minimum VCO_2 and VH_2O production and maximum VH_2O production.

Figure 3.5: Temperature significantly influenced VCO_2 production, minimum, mean and maximum RMR increasing with an increase in temperature.

Figure 3.6: Temperature significantly influenced the rate of VH_2O production. TEWL increased significantly with an increase in temperature.

LIST OF TABLES

Table 2.1: Primer pairs and PCR cycling conditions of the two mtDNA and one nuclear marker used to amplify the three gene regions.

Table 2.2: a) Haplotype (h) and nucleotide (π) diversities of 16S (top) and ND4 (centre) for northern, central and southern clades (left of matrix). b) Net sequence divergences (p -distances) between clades of *Meroles knoxii* for 16S (top), ND4 (centre) and RAG1 (bottom) markers below the diagonal and standard errors above the diagonal and within clade sequence divergence on the diagonal (shaded grey).

Table 2.3: The localities used for phylogenetic and population genetic (only *Meroles knoxii*) analyses. The sample size (N), the province in which the locality is situated, GPS coordinates and the number of individuals sequenced for each gene. Data acquired from previous studies, i.e. Lamb & Bauer (a, 2003), Edwards *et al.* (b, 2012), Engleder *et al.* (c, 2012), Makokha *et al.* (d, 2007) and samples from South African National Biodiversity Institute (e, SANBI) Reptile Tissue Bank are included. Unmarked locality tissue was taken in the field. Abbreviations: WC=Western Cape, NC=Northern Cape, EC=Eastern Cape, KZN=KwaZulu-Natal, PNR=Private Nature Reserve.

Table 3.1: Summary of the central 50% for T_{sel} of ZNR and RNR lizards. All values (minimum, maximum, range and mean) are in $^{\circ}\text{C} \pm \text{s.e.m.}$

Table 3.2: Generalized linear model for the effects of site, mass and interaction of site*mass on mean, minimum, maximum and T_{sel} range of *M. knoxii* individuals from RNR and ZNR sites combined (left). ANCOVA with body mass as covariate and with site, mass and mass*site as factors (right). Significance is indicated with *.

Table 3.3: Generalized linear model for the effects of replicate, time and sex on mean, minimum, maximum and range of T_{sel} of ZNR and RNR individuals. Significant variables are indicated with *.

Table 3.4: Generalized linear model for the effects of site, sex, mass and the interaction of site*mass on CT_{min} (left) and CT_{max} (right). Significant variables are indicated with *.

Table 3.5: Mean, minimum, maximum and range of CTL's for both sites of *Meroles knoxii*. $\pm \text{s.e.m.}$

Table 3.6: GZLM of maximal stamina (distance and time) and maximal sprint speed performance. Significant values are indicated with *.

Table 3.7: Summary of U_{max} (m s^{-1}) and T_{opt} ($^{\circ}\text{C}$) for sprint speed, distance and time travelled to exhaustion. All values (minimum, maximum, range and mean) $\pm \text{s.e.m.}$

Table 3.8: Results of GZLM for the effects of temperature, site, group, mass and the interactions thereof (site*mass, site*sex and sex*mass) on mean, minimum and maximum V_{CO_2} and V_{H_2O} . Significance is indicated with a *.

LIST OF ABBREVIATIONS

WRZ	Winter-rainfall zone
DNA	Deoxyribonucleic acid
16S	16S rRNA
ND4	NADH sodium dehydrogenase subunit 4
RAG1	Recombination activity gene 1
mtDNA	Mitochondrial DNA
nDNA	Nuclear DNA
ML	Maximum likelihood
SAMOVA	Spatial analysis of molecular variance
h	Haplotype diversity
π	Nucleotide diversity
ANOVA	Analysis of variance
SVL	Snout-vent length
T_{sel}	Selected/preferred body temperature
CTL	Critical thermal limits
CT_{min}	Critical thermal minimum
CT_{max}	Critical thermal maximum
RMR	Resting metabolic rate
TEWL	Total evaporative water loss
VCO_2	Rate of carbon dioxide production
VH_2O	Rate of water loss
T_b	Body temperature
RNR	Rietvlei Nature Reserve
ZNR	Zandvlei Nature Reserve
WC	Western Cape
NC	Northern Cape
EC	Eastern Cape
KZN	KwaZulu-Natal
PNR	Private Nature Reserve

CHAPTER 1

1.1 GENERAL INTRODUCTION

Over the last century, global anthropogenic factors have become one of the greatest threats on natural systems (Deutsch *et al.*, 2008). Global amphibian declines have been identified as a serious problem and reptiles seem to be in even greater risk of extinction (Gibbons *et al.*, 2000; Sinervo *et al.*, 2010). A recent conservation assessment for the Atlas and Red List of the Reptiles of South Africa, Lesotho and Swaziland (SARCA; Branch, 2014) identified seven threat categories for reptiles; habitat loss and degradation, introduced invasive species, environmental pollution, disease and parasitism, unsustainable use, accidental mortality and climate change. Habitat loss and degradation was identified as the greatest anthropogenic threat to South African reptiles, affecting approximately 70% of surveyed taxa (SARCA; Branch, 2014). However, climate change is likely to exacerbate several of these threat categories, including habitat loss and degradation. Climate change has recently received much attention with regards to forecasting its possible effects on biodiversity (Thomas *et al.*, 2004; Chown *et al.*, 2010; Sinervo *et al.*, 2010; Tolley *et al.*, 2016). However, climate warming effects have not been adequately assessed by IUCN Red Lists (Hoffmann *et al.*, 2010). The controversy surrounding climate change mainly stems from disagreements about the accuracy of the predicted rates and impacts of climate-induced habitat change. This is problematic, as any potential climate change threats to biodiversity will be viewed as guestimates rather than informed estimates, and this perspective could result in local and even global extinctions of biodiversity before actionable intelligence arise.

Climate change has been implicated in the decline of several vertebrate taxa (Laurance & Useche, 2009; Sinervo *et al.*, 2010). Numerous studies have already revealed a substantial shift in species' phenologies and the distribution ranges of various taxa (Walther *et al.*, 2002; Parmesan & Yohe, 2003; Genner *et al.*, 2004; Both *et al.*, 2006; Botts *et al.*, 2015). Other studies have also tried to predict the likely effects of ongoing global warming on species and ecosystems (Midgley *et al.*, 2003; Kearney *et al.*, 2008). Far fewer studies have investigated a species' physiological capability to respond to climate change or genetic capacity to adapt (Kearney & Porter, 2004; Bell & Collins, 2008; Kearney *et al.*, 2009,). When considering reptiles in a global context, by incorporating physiological characteristics into climate models, a recent study showed that seasonal air temperature changes affected the thermal habitat of Mexican *Sceloporus* lizards (Sinervo *et al.*, 2010). The increased temperatures decreased activity periods by forcing lizards into retreats to avoid overheating, resulting in reduced foraging time especially during the spring breeding season. In addition, Sinervo and colleagues (2010) showed a plausible link between increasing temperatures and local lizard extinctions. Using the same method, they extrapolated their findings to lizards globally and estimated that rupicolous cordylid lizards from South Africa are likely more threatened by increasing air temperature than terrestrial or arboreal lizards.

The general threat of climate change is already a major concern in South Africa. Mean annual temperatures have increased 1.5 times the observed global average (0.65°C) over the past 50 years and the frequency of extreme rainfall events has increased (Rutherford *et al.*, 1999; Ziervogel *et al.*, 2014). It appears that these changes are likely to continue. The South African Long Term Adaptation Scenarios and the 5th Assessment Report of the Intergovernmental Panel on Climate Change (IPCC) suggest warming of 3-6°C by 2081-2100, relative to 1986-2005. Unfortunately, precipitation changes remain less certain with regards to the direction of change and the magnitude. In addition, rising sea levels could threaten habitat availability of terrestrial coastal species. Since the mid-19th century, the rate of mean sea level rise has been larger than the mean rate for the previous two millennia, with global mean sea levels rising by 0.19m from 1901-2010. Future sea level predictions include an increase of 0.26-0.55m and 0.45-0.88 by 2081-2100, relative to current sea levels.

Recent studies of climate change in South Africa have mainly focused on biomes and vegetation types (Rutherford *et al.*, 1999; Midgley *et al.* 2001, 2002, 2005). Their predictions, using bioclimatic models, shows warming and aridification trends which could shrink South Africa's current biomes with 38-55% of their present occurrence, with the greatest losses in the northern, central and western parts of the country (Fig.1.1). The biome of greatest concern is the Succulent Karoo Biome, which could experience a complete displacement. In addition, the Fynbos, Grassland and Forest biomes could also be affected. Another study focused on 179 animal taxa (50 reptile species) and modelled a doubling of CO₂ emissions and 2°C increase in ambient temperature (Erasmus *et al.*, 2002). This study suggests an array of possible responses. Predictions show range contractions of up to 78%, range expansion of 17% and a 2% extinction risk. Furthermore, most range shifts (41%) are predicted to shift in an easterly direction, following the east-west aridity gradient of South Africa, with species losses highest in the west. Furthermore, a study on the genetic structure of lizard populations showed that population fragmentation due to loss of qualitative thermal habitat could potentially cause declines of *Bradypodion* lizards and *Pedioplanis burchelli* lacertids (Tolley *et al.*, 2009). The study expressed concern as conservation bodies generally focus on species abundance and endemism, where landscape genetics could be a valuable tool to gauge evolutionary potential to cope with future climate changes. In addition, extrapolating species responses to climate change across taxa would be negligent, as geographic regions are unlikely to experience climate change at the same tempo and mode. Given climate change predictions, how would warming affect species, globally and locally?

In order to preserve our biodiversity with impending climate change, we need to understand how species currently react with their abiotic and biotic environments and how these interactions are likely to change with global warming (Schaefer *et al.*, 2008). Immediate impacts on whole organisms would include changes in life history, abundance, distribution, physiology, morphology and these changes may result in local extinction (Parmesan, 2006; Schaefer *et al.*, 2008) and

possibly global extinctions (Thomas *et al.*, 2004; Sinervo *et al.*, 2010). In order to survive, species of ectotherms could respond to climate change through phenotypic plasticity or evolutionary adaptation, but these changes might not be possible at the rate imposed by global warming (Gienapp *et al.*, 2007; Visser, 2008) or these conditions could not have been present within some species' evolutionary histories (Ghalambor *et al.*, 2007). Alternatively, species could migrate to more favourable climatic envelopes; however, the success relies heavily on the species' dispersal ability and the availability of favourable areas to relocate to (Thomas *et al.*, 2004).

Dispersal ability is possibly one of the most important factors influencing future species distributions (Duckett *et al.*, 2013). The significance of considering dispersal when predicting changes in species' distribution has been acknowledged (Cain *et al.*, 1998; Guisan & Thuiller, 2005; Araújo *et al.*, 2006). Genetic techniques can be used to measure dispersal indirectly

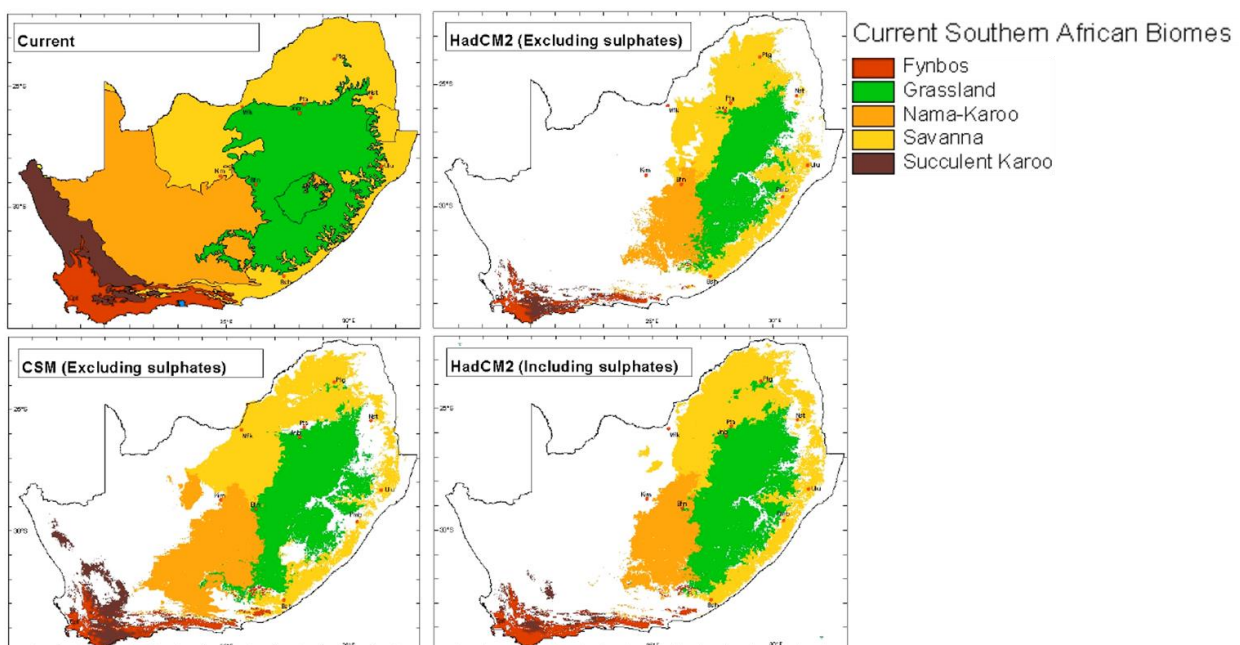

Figure 1.1: Current and potential future distribution of South African biomes. These maps and predictions have been adopted from Rutherford and colleagues (1999). White areas indicate future unknown biomes and climates.

(Stow *et al.*, 2001). However, in order to understand dispersal potential of species, the factors driving a species current distribution should be discerned. Likewise, species physiological capabilities are just as important to understand which variables possibly dictate the extent of their occurrence and persistence and how they utilize their available habitat. In the event of current habitats becoming unsuitable and if dispersal to favourable habitat is not possible due to factors such as habitat fragmentation or habitat loss (Thomas *et al.*, 2004), adaptive or plastic responses are the alternative. Natural selection is thought to act directly on ecologically relevant factors where behavioural, morphological and physiological traits directly influence the fitness of an organism (Arnold, 1983). If the compensating behavioural changes lead to a diminished physiological

capacity, selection should promote parallel changes in the organisms' physiology and morphology, thus increasing capacity and re-establishing coadaptation (Huey, 1987).

Ectotherms are excellent model organisms to identify possible responses to climate change. Almost all aspects of an ectotherms behaviour and physiology are sensitive to their body temperature (Huey, 1974). These aspects include movement (Bauwens *et al.*, 1995), foraging ability (Ayers & Shine, 1997) and growth and feeding rates (Kingsolver & Woods, 1997; Aubret & Shine, 2010). These organisms obtain most of their body heat from their environments, through solar radiation, convection and conduction and predominantly rely on behavioural thermoregulation (shuttling between sun and shade) to buffer the thermal heterogeneity of their environments, maintain preferred body temperatures and curb overheating (Huey 1974; Kühr *et al.*, 2005). Therefore, reptiles provide an exceptional opportunity to investigate the aspects driving species physiological and behavioural responses to variable thermal landscapes. Unfortunately, as energy drives these major processes, they could be highly vulnerable to changes in their abiotic environments (Adolph & Porter, 1993; Angilletta *et al.*, 2002; Martin & Huey, 2008; Angilletta, 2009). For instance, the ability of lacertid lizards to respond to the rapid climatic changes through evolutionary means might be limited (Bauwens *et al.*, 1995). Therefore, the yoke could lie upon their physiological capability to compensate, either through behavioural thermoregulation or thermal plasticity (Aubret & Shine, 2010). If species are not able to respond rapidly to changing environments, they may face extinction.

Typically, lizards behaviourally thermoregulate by seeking cooler refuges (burrows) on hot days or shuttling between warm and cold microsites to maintain optimal body temperatures (Huey, 1974). Temperate lizards, relative to tropical and inland species, have been identified as least concern with respect to climate change (Kearney *et al.*, 2008). However, these assumptions mainly focus on the availability of optimal thermal habitat and lizards' ability to buffer overheating through shuttling. For instance, certain tropical lizards already occur in shaded areas and the possibilities to retreat to cooler refuges are limited (Huey *et al.*, 2009). Coastal temperate species could face either predicament: spending more time in their burrows to avoid overheating on hot days or spending more time basking to obtain optimal body temperatures on cold days. For the former, longer periods in refuges reduce foraging time possibly resulting in an insufficient net energy gain for reproduction (Huey *et al.*, 2010). For the latter, lizards would likely not be able to acquire these optimal 'core' temperatures in heavily shaded areas (Kearney *et al.*, 2009). In addition, increased basking periods could put individuals at greater risk of predation, which in turn could curb population abundance and persistence. Temperate west coast lizards could face a relatively greater challenge as increased temperatures coupled with decreases in annual winter rainfall in the Western Cape is thought to further exacerbate the severity of climate change in this region (Meadows, 2006).

There is clearly a need to investigate the capacity of ectotherms to cope with changing thermal environments as the inability to adapt to novel environments or disperse to favourable habitat could result in diminished fitness capacities. However, in order to do so, numerous traits need to be considered, such as the climatic drivers that shape a species current occurrence and contemporary thermal capacity. Identifying these variables could aid in understanding a species ability to respond to climate change.

In the present study, the southern African endemic lacertid lizard, *Meroles knoxii* was used to investigate the genetic and physiological potential of a temperate west coast lizard to adapt to climate change. The South African west coast comprises two of the threatened biomes mentioned before, the Succulent Karoo and Fynbos biomes, both limited by the winter-rainfall zone with centres of high endemism (Rutherford *et al.*, 1999). The entire coastal region is associated with steep thermal and rainfall gradients, with temperatures decreasing and rainfall increasing on north-south axes (Fig. 1.2). These gradients are likely affected by the cold north flowing Benguela Current and the winter rainfall zone (Lutjeharms, 1998; Schumann, 1998; Tyson & Preston-Whyte, 2000; Chase & Meadows, 2007). Changes in future climate could potentially affect these gradients as ocean circulation disruptions predict cascading effects for marine environments (IPCC, 2014). If these gradients affect *M. knoxii*, climate change could impact this temperate species. Climate warming of 3-6°C (IPCC, 2014), could potentially curb activity periods for this cold-adapted lizard. The west coastal region is associated with high incidence of fog and cloud cover (Janse van Rensburg *et al.*, 2009). The direction and magnitude of future changes in rainfall in South Africa are uncertain (Ziervogel, 2014). However, it is conceivable that changes in fog and cloud cover could also occur. If, for instance, the incidence of fog and cloud cover increases, potential activity of lizards could be further restrained. As reptiles in the western region of South Africa are likely to face a challenging environment with thermal landscape changes and their habitats threatened with potential biome shifts and losses, *M. knoxii* could prove a model ectotherm to study a reptile's possible response to climate change.

As *Meroles knoxii* has a distribution (Fig. 1.2; Branch, 1998), encompassing the climatically variable west coastal strip with partial dispersal inland, presumably via the Tankwa Karoo basin, this lizard is likely to show phylogeographic structure. In Chapter 2, phylogeographic inference is used to investigate the possibility of phylogeographic structure which could aid in understanding the species possible past and contemporary ecological drivers as well as identifying the extent of genetic groups and the genetic diversity of these groups. This information could be vital in determining whether climatic drivers could be responsible for *M. knoxii* contemporary occurrence and identifying potential dispersal barriers given future climate change. In Chapter 3, two populations from *M. knoxii*'s southern extent are used to investigate whether the thermal profile of

this species could differ at a small spatial scale by estimating several physiological traits. These profiles could identify which traits could be more variable and relevant for climate change

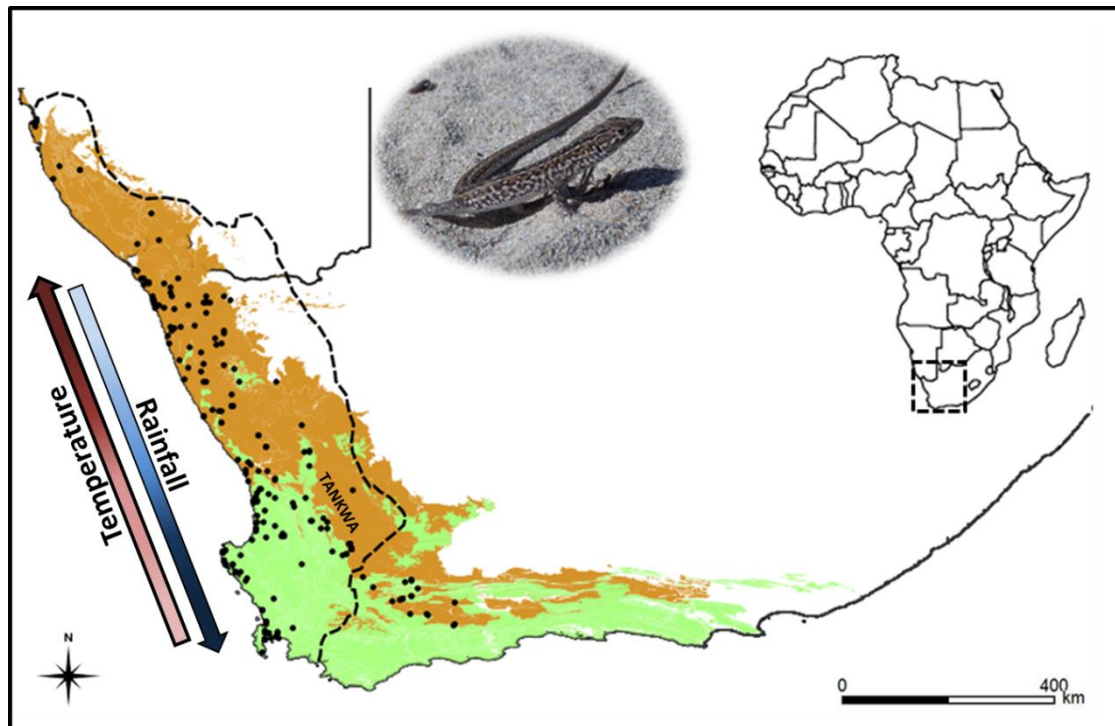

Figure 1.2: Point locality records (black dots) of *Meroles knoxii* (insert) occurring along the west coast of southern Africa. Succulent Karoo and Fynbos Biomes are indicated in brown and green, respectively. Winter-rainfall zone (WRZ) occurs west of the dotted line. Temperature and rainfall gradients occur in opposite directions on north-south axes along the coastline.

predictions. In addition, identifying whether these populations have a wide or narrow thermal tolerance breadth could aid in understanding physiological capacity to cope with increased body temperatures and which body temperatures provide optimal performance capacities for foraging. It is equally important to examine how body temperature affects the resting metabolic rates and total evaporative water loss of these populations. In doing so, possible responses of southern populations of *M. knoxii* to climate change can be discerned if these traits are used in conjunction with climate change scenarios.

1.2 REFERENCES

Adolph, S.C., Porter, W.P. 1993. Temperature , activity and lizard life histories. *The American Naturalist* **142**: 273–95.

Angilletta, M.J., Niewiarowski, P.H., Navas, C.A., 2002. The evolution of thermal physiology in ectotherms. *Journal of Thermal Biology* **24**: 249–268.

Angilletta, M.J., 2009. Thermal Adaptation: A theoretical and empirical synthesis. *Oxford University Press Inc.*, New York.

Araújo, M.B., Thuiller, W., Pearson, R.G. 2006. Climate warming and the decline of amphibians

and reptiles in Europe. *Journal of Biogeography* **33**: 1712-1728.

Arnold, E.N. 1983. Morphology, performance and fitness. *American Zoology* **23**:347-361.

Aubret, F., Shine, R., 2010. Thermal plasticity in young snakes : how will climate change affect the thermoregulatory tactics of ectotherms? *The Journal of Experimental Biology* **213**:242-248.

Ayers, D.Y., Shine, R., 1997. Thermal influences on foraging ability: body size , posture and cooling rate of an ambush predator, the python *Morelia spilota*. *Functional Ecology* **11**: 342–347.

Bauwens, D., Damme, V.A.N., 1995. Evolution of sprint speed in lacertid lizards: Morphological, physiological and behavioral covariation **49**: 848–863.

Bell, G., Collins, S. 2008. Adaptation, extinction and global change. *Evolutionary Applications* **1**: 3-16.

Both, C., Bouwhuis, S., Lessels, C.M., Visser, M.E. 2006. Climate change and population declines in a long-distance migratory bird. *Nature* **441**: 81–84.

Botts, E.A., Erasmus, B.F.N., Alexander, G.J. 2015. Observed range dynamics of South African amphibians under conditions of global change. *Austral Ecology* **40**: 309-317.

Branch, W.R. 1998. Field guide to snakes and other reptiles of southern Africa. 3rd Edition. Struik Publishers. Cape Town, South Africa.

Branch, W.R. 2014. Conservation status, diversity, endemism, hotspots and threats. Editors: Bates, M.F., Branch, W.R., Bauer, A.M., Burger, M., Marais, J., Alexander, G.J., de Villiers, M.S. Atlas and Red List of the Reptiles of South Africa, Lesotho and Swaziland. *Suricata* 1. South African National Biodiversity Institute, Pretoria.

Cain, M.L., Damman, H., Muir, A. 1998. Seed dispersal and the Holocene migration of woodland herbs. *Ecological Monographs* **68**: 325-347.

Chase, B. M., Meadows, M. E. 2007. Late Quaternary dynamics of southern Africa's winter rainfall zone. *Earth Science Reviews* **84**: 103-138.

Chown, S.L., Hoffmann, A.A., Kristensen, T.N., Angilletta, M.J., Stenseth, N.C., Pertoldi, C. 2010. Adapting to climate change: a perspective from evolutionary physiology. *Climate Research* **43**: 3-15.

Deutsch, C.A., Tewksbury, J.J., Huey, R.B., Sheldon, K.S., Ghalambor, C.K., Haak, D.C., Martin, P.R. 2008. Impacts of climate warming on terrestrial ectotherms across latitude. *Proceedings of the National Academy of Sciences* **105**: 6668-6672.

- Duckett, P.E., Wilson, P.D. & Stow, A.J., 2013. Keeping up with the neighbours: Using a genetic method of dispersal and species distribution modelling to assess the impact of climate change on an Australian arid zone gecko (*Gehyra variegata*). *Diversity and Distribution* **19**: 964–976.
- Erasmus, B.F.N., Jaarsveld, A.S.V.A.N. & Chown, S.L., Kshatriya, M., Wessels, K.J. 2002. Vulnerability of South African animal taxa to climate change. *Global Change Biology* **8**: 679–693.
- Genner, M.J., Sims, D.W., Wearmouth, V.J., Southall, E.J., Southward, A.J., Henderson, P.A., Hawkins, S.J. 2004. Regional climatic warming drives long-term community changes of British marine fish. *Proceedings of the Royal Society of London B* **271**: 655–661.
- Ghalambor, C.K., McKay, J.K., Carroll, S.P., Reznick, D.N. 2007. Adaptive versus non-adaptive phenotypic plasticity and the potential for contemporary adaptation in new environments. *Functional Ecology* **21**: 394-407.
- Gibbons, J.W., Scott, D.W., Ryan, T.J., Buhlmann, K.A., Tuberville, T.D., Metts, B.S., Greene, J.L., Mills, T., Leiden, Y., Poppy, S., Winne, C.T. 2000. The global decline of reptiles , déjà vu amphibians. *Bioscience* **50**: 653–666
- Gienapp, P., Teplitsky, C., Alho J.S., Mills J.A., Merila, J. 2007. Climate change and evolution: disentangling environmental and genetic responses. *Molecular Ecology* **17**: 167–178.
- Guisan, A., Thuiller, W. 2005. Predicting species distribution: offering more than simple habitat models. *Ecology Letter* **8**: 993-1009.
- Hoffmann, M., Hilton-Taylor, C., Angulo, A., Böhm, M., Brooks, T.M.... 2010. The impact of conservation on the status of the world's vertebrates. *Science* **330**: 1503-1509.
- Huey, R.B. 1974. Behavioral thermoregulation in lizards: importance of associated costs. *Science* **184**: 1001-1003.
- Huey, R.B. 1982. Temperature, physiology and the ecology of reptiles. In: Reptile physiology and ecology, pp. 25-91.
- Huey, R.B. 1987. Phylogenetic studies of co-adaptation: preferred temperatures versus optimal performance temperatures of lizards. *Evolution* **41**: 1098-1115.
- Huey, R.B., Deutsch, C.A., Tewksbury, J.J., Vitt, L.J., Hertz, P.E., Perez, H.J.A., Garland, T. 2009. Why tropical forest lizards are vulnerable to climate warming. *Proceedings of the Royal Society B: Biological Sciences* **276**: 1-10.
- Huey, R.B., Losos, J.B., Moritz, C. 2010. Are lizards toast? *Science* **328**: 832–833.

- Intergovernmental Panel on Climate Change (IPCC) 2014. The scientific basis. Contribution of Working Group I to the Fifth Assessment Report of the Intergovernmental Panel on Climate Change.
- Intergovernmental Panel on Climate Change (IPCC) 2014. Impacts, adaptation and vulnerability. Contribution of Working Group II to the Fifth Assessment Report of the Intergovernmental Panel on Climate Change.
- Janse Van Rensburg, D.A., Mouton, P.F.N., Van Niekerk, A., 2009. Why cordylids are black at the south-western tip of Africa. *Journal of Zoology* **278**: 333–341.
- Kearney, M., Porter, W.P. 2004. Mapping the fundamental niche: physiology, climate and the distribution of a nocturnal lizard. *Ecology* **85**: 3119–3131.
- Kearney, M., Phillips, B.L., Tracy, C.R., Christian, K.A., Betts, G., Porter, W.P. 2008. Modelling species distributions without using species distributions: the cane toad in Australia under current and future climates. *Ecography* **31**: 423-434.
- Kearney, M., Porter, W.P., Williams, C., Ritchie, S., Hoffman, A.A. 2009. Integrating biophysical models and evolutionary theory to predict climatic impacts on species' ranges: the dengue mosquito *Aedes aegypti* in Australia. *Functional Ecology* **23**: 528-538.
- Kingsolver, J.G., Woods, H.A. 1997. Thermal sensitivity of growth and feeding in *Manduca sexta* caterpillars. *Physiological and Biochemical Zoology* **70**: 631–638.
- Kührt, U., Samietz, J., Dorn, S. 2005. Thermoregulation behaviour in codling moth larvae. *Physiological Entomology* **30**: 54–61.
- Laurance, W.F., Useche, D.C. 2009. Environmental synergisms and extinctions of tropical species. *Conservation Biology* **23**: 1427–1437.
- Lutjeharms, J.R.E. 1998. Coastal hydrography. In: *Field guide to the eastern and southern Cape coasts*. Editors: Lubke, R.A. & De Moor, I. University of Cape Town Press, Cape Town, pp. 50–62.
- Martin, T.L., Huey, R.B., 2008. Why “suboptimal” is optimal: Jensen’s inequality and ectotherm thermal preferences. *The American Naturalist* **171**: 102–118.
- Meadows, M.E., 2006. Global change in southern Africa. *Geographical Research* **44**: 135-145.
- Midgley, G.F., Rutherford, M.C., Bond, W.J., Barnard, P. 2001 The heat is on....Impacts of climate change on plant diversity in South Africa. South African National Biodiversity Institute, Cape Town, South Africa.

- Midgley, G.F., Hannah, L., Millar, D., Rutherford, M.C., Powrie, L.W. 2002 Assessing the vulnerability of species richness to anthropogenic climate change in a biodiversity hotspot. *Global Ecology & Biogeography* **11**: 445-451.
- Midgley, G.F., Hannah, L., Millar, D., Thuiller, W., Booth, A. 2003. Developing regional and species-level assessments of climate change impacts on biodiversity in the Cape Floristic Region. *Biological Conservation* **112**: 87-97.
- Midgley, G.F., Chapman, R.A. Hewitson, B., Johnston, P., De Wit, M., Ziervogel, G., Mukhelbir, P., Van Niekerk, L., Tadross, M., Van Wilgen, B.W., Kgope, B., Morant, P.D., Theron, A., Scholes, R.J., Forsyth, G.G. 2005. A status quo, vulnerability and adaptation assessment of the physical and socio-economic effects of climate change in the Western Cape. CSIR Environmentek Stellenbosch. South African National Biodiversity Institute, Kirstenbosch Research Centre, Cape Town, South Africa.
- Parmesan, C., Yohe, G., 2003. A globally coherent fingerprint of climate change impacts across natural systems. *Nature* **421**: 37-42
- Parmesan, C. 2006. Ecological and evolutionary responses to recent climate change. *Annual Review of Ecology, Evolution and Systematics* **37**: 637-669.
- Rutherford, M.C., Midgley, G.F., Bond, W.J., Powrie, L.W., Roberts, R., Allsopp, J. 1999. Plant biodiversity In Kiker, G., Climate change impacts in southern Africa. Report to the National Climate Change Committee, Department of Environmental Affairs and Tourism, Pretoria.
- Schaefer, H., Jetz, W., Böhning-Gaese, K., 2008. Impact of climate change on migratory birds: community reassembly versus adaptation. *Global Ecology and Biogeography* **17**: 38–49.
- Schumann, E.H. 1998. The coastal ocean off southeast Africa, including Madagascar coastal segment. In: *The sea: the global coastal ocean II. Regional studies and syntheses. 11*. Editors: Robinson, A.R., Brink, K.H. 557–581.
- Sinervo, B., Mendez-de-la-Cruz, F., Miles, D.B., Heulin, B., Bastiaans, E., Cruz, M.V., Lara-Resendiz, R., Martinex-Mendez, N., Calderon-Espinosa, M.L., Meza-Lazaro, R.N..... 2010. Erosion of lizard diversity by climate change and altered thermal niches. *Science* **328**: 894-899.
- Stow, A.J., Sunnucks, P., Briscoe, D.A., Gardner, M.G. 2001. The impact of habitat fragmentation on dispersal of Cunningham's skink (*Egernia cunninghami*): evidence from allelic and genotypic analyses of microsatellites. *Molecular Ecology* **10**: 867-878.
- Thomas, C.D., Cameron, A., Green, R.E., Bakkenes, M., Beaumont, L.J., Collingham, Y.C., Erasmus, B.F.N., De Siqueira, M.F., Grainger, A., Hannah, L., Hughes, L., Huntley, B., Van

Jaarsveld, A.S., Midgley, G.F., Miles, L., Ortega-Huerta, M.A., Peterson, A.T., Phillips, O.L., Williams, S.E. 2004. Extinction risk from climate change. *Nature* **427**: 145-148.

Tolley, K.A., Makokha, J.S., Houniet, D.T., Swart, B.L., Matthee, C.A. 2009. The potential for predicted climate shifts to impact genetic landscapes of lizards in the South African Cape Floristic Region. *Molecular Phylogenetics and Evolution* **51**: 120-130.

Tolley, K.A., Alexander, G.J., Branch, W.R., Bowles, P., Maritz, B. 2016. Conservation status and threats for African reptiles. *Biological Conservation* xxx.

Tyson, P.D., Preston-Whyte, R.A. 2000. The atmosphere, weather and climate of southern Africa. Cape Town: Oxford University Press.

Visser, M.E. 2008. Keeping up with a warming world: assessing the rate of adaptation to climate change. *Proceedings of the Royal Society B: Biological Sciences* **275**: 649–659.

Walther, G.R., Post, E., Convey, P., Menzel, A., Parmesan, C., Beebee, T.J.C., Fromentin, J., Hoegh-Guldberg, O., Bairlein, F. 2002. Ecological responses to recent climate change. *Nature* **416**: 389-395.

Ziervogel, G., New, M., Van Garderen, E.A., Midgley, G., Taylor, A., Hamann, R., Stuart-Hill, S., Myers, J., Warburton, M. 2014. Climate change impacts and adaptation in South Africa. *WIREs Clim Change* **5**: 605-620.

CHAPTER 2

Phylogeographic occurrence of *Meroles knoxii* suggests influences of historic sea level fluctuations and contemporary climatic gradients

2.1 INTRODUCTION

Genetic differentiation is caused by an accumulation of differences in allelic frequencies between isolated or partially isolated populations. These differences accumulate due to evolutionary forces, such as natural selection or genetic drift. Although both forces promote genetic change, drift is a mechanism of chance, whereas selection can be imposed by environmental challenges, for example, by natural selection through adaptive radiation, a process in which organisms diversify rapidly into a multitude of new forms (Slatkin, 1987, Smith, 1989). These forms arise when ecological opportunity affords ancestral species novel environments in which resources are abundant and underutilized (Gavrilets & Losos, 2009). Ecological opportunities are utilized by colonizing under populated areas, extinction of previously ecologically dominant groups or key innovations (evolution of a trait that allows the lineage innovative interactions with novel environments). Conversely, divergence due to random genetic drift occurs when intraspecific populations become isolated through vicariance. Populations become isolated from each other, due to a barrier to gene flow, and this isolation ultimately leads to genotypic and/or phenotypic divergence. The effects of genetic drift can be substantial in small founder or peripheral populations (Mayr, 1963), resulting in allopatric speciation.

Several general patterns have emerged concerning the temporal, spatial and genetic or morphological properties of adaptive radiation (Gavrilets & Losos, 2009). When considering phylogenetic and population genetic evidence, the stages of vertebrate evolutionary radiation seem to follow similar trajectories (Streelman & Danley 2003; Ackerly *et al.*, 2006; Gavrilets & Losos, 2009). Numerous specialists in the field of adaptive radiation agree upon the “habitat first” model of speciation, based on the parsimonious assumption that the evolutionary rates don’t change dramatically over time (Diamond, 1986; Schluter, 2000; Streelman & Danley 2003; Ackerly *et al.*, 2006; Gavrilets & Losos, 2009). Therefore, if habitat divergence characterizes the first stage of speciation among close relatives then it would also represent the early speciation event that initiates adaptive radiation. However, “habitat” is an ambiguous term, where in some instances researchers refer to microhabitat (Streelman & Danley 2003) and others refer to macrohabitat (Ackerly *et al.*, 2006; Gavrilets & Losos, 2009), leading to the conclusion that both possibly contribute to habitat divergence (Danley & Kocher, 2001). Although the pattern is not universal, simply put, taxa seem to diverge along the axes of habitat (macrohabitat followed by microhabitat), trophic morphology and communication, usually in that order (Danley & Kocher, 2001; Streelman & Danley 2003; Gavrilets & Losos, 2009). These stages have been proposed for *Anolis* lizards that first diverged in body size, then structural microhabitat and finally microclimate (Losos, 2009; Williams, 1972). Several selective pressures could occur during the stages of radiation, i.e. competition for food or space and sexual selection, which further promote divergence. While a divergent selective pressure may predominate during a certain episode it is unlikely that a single pressure operates to the exclusion of others (Danley & Kocher, 2001). However, many factors can

restrict the order in which niche axes are partitioned during divergence, i.e. strength of selection, available genetic variation, environmental heterogeneity and initial ancestral condition of a clade (Schluter, 2000; Gavrillets, 2004).

In addition to the stages of adaptive radiation, another pattern observed is that of the selection gradient effect (Gavrillets & Losos, 2009). Typically, speciation is characterized by long-term geographical isolation which in turn leads to allopatric speciation. When geographical isolation is absent, diversification is hindered by gene flow. However, numerous observations suggest species distributed across a geographic landscape could experience differing selection pressures. Even if gene flow is present, populations on different sides of an environmental gradient may diverge and adapt to local conditions (Schneider & Moritz, 1999, Smith *et al.*, 2001). There seems to be a relationship between geographical patterns and ecological processes of speciation in spatially structured populations (Doebeli & Dieckmann, 2003; Kawata *et al.*, 2007). Populations are usually spatially structured when movement only occurs over short distances and ecological interactions are between localized individuals. Evolutionary branching occurs in these spatially structured populations along an environmental gradient, especially if the gradient is of intermediate slope, i.e. the changes in temperature, humidity or soil nutrients are gradual. However, when gradients are too shallow, selection pressures are not strong enough to drive divergence and speciation. In contrast, if gradients are too steep, selection is strong and prevents populations from spreading to unoccupied areas (Gavrillets & Losos, 2009).

Three broad patterns of geographic modes of speciation have been identified to occur when populations are isolated from one another: allopatric, sympatric and parapatric speciation, with allopatric speciation considered the most common (Bush, 1975). In general, evolutionary biologists agree that speciation occurs when gene flow between diverging populations is reduced to the point where novel alleles entering a population due to hybridization will be eliminated by natural selection. However, uncertainty arises when considering whether the divergence is resultant of extrinsic factors such as geographic barriers or whether due to intrinsic factors such as unique genotypes arising from novel environments whilst still in contact with parental populations.

Historical global climate changes are considered to have had a major influence in causing diversification and radiation of species, including a number of species in Africa (deMenocal, 1995; Potts, 1996). Furthermore, historic climatic fluctuations are thought to be drivers of adaptive radiation of various species (Kimbel, 1995; Bobe *et al.*, 2002; Linder, 2003; Bowie *et al.*, 2004; deMenocal, 2004). In southern Africa, numerous studies have shown the possibility that past climatic events could have influenced lineage diversification of flora (Linder *et al.*, 1992; Midgley *et al.*, 2001) and fauna (Gouws *et al.*, 2004; Daniels *et al.*, 2004, 2007; Botts *et al.*, 2013, 2015), including reptiles (Matthee & Flemming, 2002; Tolley *et al.*, 2008; Swart *et al.*, 2009; Barlow *et al.*, 2013). Numerous studies have also associated climate driven vegetation shifts as potential

processes to have contributed to this diversity (Tolley *et al.*, 2006; Price *et al.*, 2007; Swart *et al.* 2009), with sea level changes thought to indirectly influence clade diversification through climate change.

Ectotherms, such as reptiles, are directly influenced by their climatic environment (Angilletta *et al.*, 2002). Temperature is considered one of the most important climatic variables. Almost all aspects of an ectotherms behaviour and physiology are sensitive to body temperature (Huey, 1982). These aspects include movement (Bauwens *et al.*, 1995), foraging ability (Ayers & Shine, 1997) and growth and feeding rates (Kingsolver & Woods, 1997; Aubret & Shine, 2010). In the event of climate change, species are either forced to disperse to favourable habitat, adapt locally to their novel environment or go extinct (Visser, 2008). Consequently, climate and habitat can directly influence a species occurrence, persistence and survival. For instance, South African chameleons' rapid radiation is thought to coincide with the generation of novel habitats caused by historic climatic fluctuations (Tolley *et al.*, 2008). However, when considering a single species, could the path to speciation be discernable?

The lacertid lizard, *Meroles knoxii*, occurs across a relatively wide distribution range with variable climatic environments and over two biomes; the Succulent Karoo and Fynbos biomes (Fig. 2.1), denoted as the Greater Cape Floristic Region (GCFR; Born *et al.*, 2007). The GCFR is characterized as an area of high endemism and exceptionally high plant biodiversity (Born *et al.*, 2007; Linder *et al.*, 2010). The incidence of such high endemism and diversity has been attributed to the relatively stable climate of this region since the Pliocene (Linder, 2003; Cowling *et al.*, 2009). Studies have revealed higher genetic diversity, phylogeographic structure and intraspecific genetic lineage turnover in the western GCFR for several taxa (Tolley *et al.*, 2006, 2009; Price *et al.*, 2007; Linder *et al.*, 2010; Barlow *et al.* 2013). Given that past climatic fluctuations and environmental gradients may be drivers of speciation, *M. knoxii* is potentially in the process of diversification.

This lacertid occupies a complex climatic distribution range, from a hyper-arid temperate climate in the north to a semi-arid temperate Mediterranean climate in the south. The gradient is heavily influenced by the cold north flowing Benguela Current and winter-rainfall resulting from temperate frontal systems embedded in the westerlies (Lutjeharms, 1998; Schumann, 1998; Tyson & Preston-Whyte, 2000; Chase & Meadows, 2007), curbing extreme temperatures with cooling marine air and increased fog cover in the north (Mucina *et al.*, 2006). Additionally, a steep north-south decreasing rainfall gradient occurs along the coastline (Mucina *et al.*, 2006), further contributing to the climatic complexity of the region. The majority of this species distribution occurs in the winter rainfall zone (Schulze, 2007; Stowe & Sealy, 2015, Fig. 2.1), suggesting a possible partial dependence on seasonal winter rainfall that could limit dispersal to the eastern summer rainfall region. Furthermore, the western GCFR is thought to have been relatively climatically stable since the Pliocene, whereas the Nama-Karoo region to the east of its distribution shows

relatively high levels of climatic fluctuation during that same time, with biomes expanding and contracting resulting in climatic instability (Tolley *et al.*, 2014). The climatic instability of the eastern region could have been climatically unfavourable for *M. knoxii* and in effect, have curbed potential dispersal to the eastern part of southern Africa.

Apart from the climatic gradient, substrates differ across the region, with the northern Succulent Karoo biome consisting mainly of clay soils and the southern Fynbos biome consisting of sandy soils (Lechmere-Oertel & Cowling, 2001). Furthermore, the Benguela Current creates wind-blown sand movement corridors (Desmet, 1996; Driver *et al.*, 2003), potentially advantageous for lizard movement across the landscape. As substrate influences lizard morphology (Kohlsdorf *et al.*, 2001) and performance (Vanhooydonck *et al.*, 2015) vital to survival traits, such as predator evasion, feeding and competition, the differing substrates could play a role in divergence for *M. knoxii*.

The climatic gradient and differences in vegetation/habitat across the species range may impact phenotypic divergence for functional traits but also body size. *M. knoxii* appears to display differences in body size consistent with the north-south gradient (Branch, 1998; S. Edwards, pers. comm.), and could be an indication of local adaptation to environmental temperatures. The northern region experiences mean annual temperatures of 20°C and the southern region experiences mean annual temperatures of 16.5°C. Whereas, the minimum and maximum temperatures for the northern region is 14.1°C and 23.8°C, respectively, and southern minimum and maximum temperatures are 9.2°C and 20.3°C, respectively (Shulze, 2007). Bergmann's rule states that populations or species (mammals and birds) are larger in colder environments and smaller in warmer region (Bergmann, 1847). However, for ectotherms such as lizards, the converse of Bergmann's rule could apply as several mechanisms could cause smaller body sizes to be advantageous in cooler climates (Ashton & Feldman, 2003). For instance, increased surface area to volume allows rapid heating and cooling (Cowles, 1945; Bogert, 1949; Stevenson, 1985), smaller individuals could more accurately control behavioural thermoregulation to assist in digestion and development. In contrast, efficient behavioural thermoregulation in warmer climates could be less important (Shine and Madsen, 1996), relaxing body size selective pressures and permitting lizards to attain larger sizes for other benefits, i.e. competition or predation (Peters, 1983). Although there is evidence to support the inverse of Bergmann's rule for reptiles, the rule remains controversial for a variety of ectotherms (Partridge & Coyne, 1997; Angilletta & Dunham, 2003; Walters & Hassall, 2006) and reptiles (Ashton & Feldman, 2003; Sears & Angilletta, 2004; Pincheira-Donoso *et al.*, 2008). Therefore, although Bergmann's rule (or the inverse thereof), could be plausible for body size patterns observed, environmental temperatures does not necessarily solely encompass the mechanism driving body size differences.

Incidentally, *M. knoxii* is the only species of the genus *Meroles* to occur in both xeric and mesic environments (Fig. 2.2), suggesting this species has some ecological advantage to occupy the mesic Mediterranean areas as the other species of this genus appear to be restricted to warm temperate/arid regions. In addition the majority of these species occur along the arid western coastal plains of southern Africa, suggesting *M. knoxii* could have diverged in the northern regions of southern Africa and subsequently moved south to the west Cape coast. Furthermore, a recent study estimated the divergence of *M. suborbitalis*, which is *M. knoxii*'s sister taxon (Edwards *et al.*, 2012), to have occurred around ~20mya, during the early Miocene (Hipsley *et al.*, 2009). As sister taxa are thought to diverge historically at approximately the same time, *M. knoxii* likely also originated ~20my ago. Although no molecular dating was implemented for this study, the approximate date of divergence could shed some light on the historical evolutionary processes that could have contributed to the current phylogeographic distribution of genetic entities, if found, for *M. knoxii*.

The western GCFR is associated with high intraspecific genetic lineage turnover for reptiles (Tolley *et al.*, 2009, Linder *et al.* 2010). Given the widespread distribution of *M. knoxii* across two biomes with strong climatic gradients, there is potential for genetic structure in this species. If these environmental factors have contributed to the evolution of genetic groups, there should be a correlation between genetic structure and either biomes or alternatively with the climatic (thermal) gradient. The correlation would not suggest causation, meaning that if the geographic genetic distribution does match biome extent or shows patterns consistent with the climatic gradient observed, it is not necessarily caused by these abiotic factors, other entities might be responsible. The contemporary distribution of biomes have not been static, these biomes are thought to have historically shifted their distributions on a north-south axis due to climatic oscillations since the Pleistocene (Midgley & Roberts, 2001; Midgley *et al.*, 2001). Therefore, the historic distributions of the Succulent Karoo and Fynbos Biomes could match the contemporary genetic distribution of *M. knoxii*. In addition, body size could be influenced by the temperature differential created by the climatic gradient, whereby individuals from the north would have larger body sizes relative to individuals in the south. In the event that both genetic and morphological differences coincide, diversification in this species might have been driven by local adaptation along a selection gradient. To test these hypotheses, I investigated the distribution of genetic differentiation first with a phylogenetic approach using maximum likelihood and Bayesian analysis of three molecular markers (two mtDNA and one nDNA) for *M. knoxii* from across its entire distribution range. Furthermore, population genetic structure was examined using spatial analysis of molecular variance (SAMOVA) across the range, as well as at a finer scale on the southern extent of the distribution range. To examine whether morphology (body size) changes along the gradient, an ANOVA was used to evaluate snout-vent-length differences among the identified genetic clades.

2.2 METHODS

2.2.1 Fieldwork/Sampling

Data from previous studies (9 sites) within the current distribution range of *Meroles knoxii* (Lamb & Bauer, 2003; Makokha *et al.*, 2007, Edwards *et al.*, 2012, Engleder *et al.*, 2012) were used, in addition to eight sites acquired through the Reptile Tissue bank and five sites sampled for this study (Fig. 2.1, Table 2.3). Lizards were captured in the field using a noosing technique, a GPS waypoint was taken at the capture location. DNA samples, consisting of a tail clip of approximately 1cm, were taken from each individual and stored in 99% ethanol. Each individual's snout vent length (SVL) and tail length (TL) was measured; using digital callipers to the nearest mm. Digital photographs were taken of lizards on 1cm² grid paper to create a visual database for post referencing purposes. After measurements were completed individuals were released at their respective points of capture.

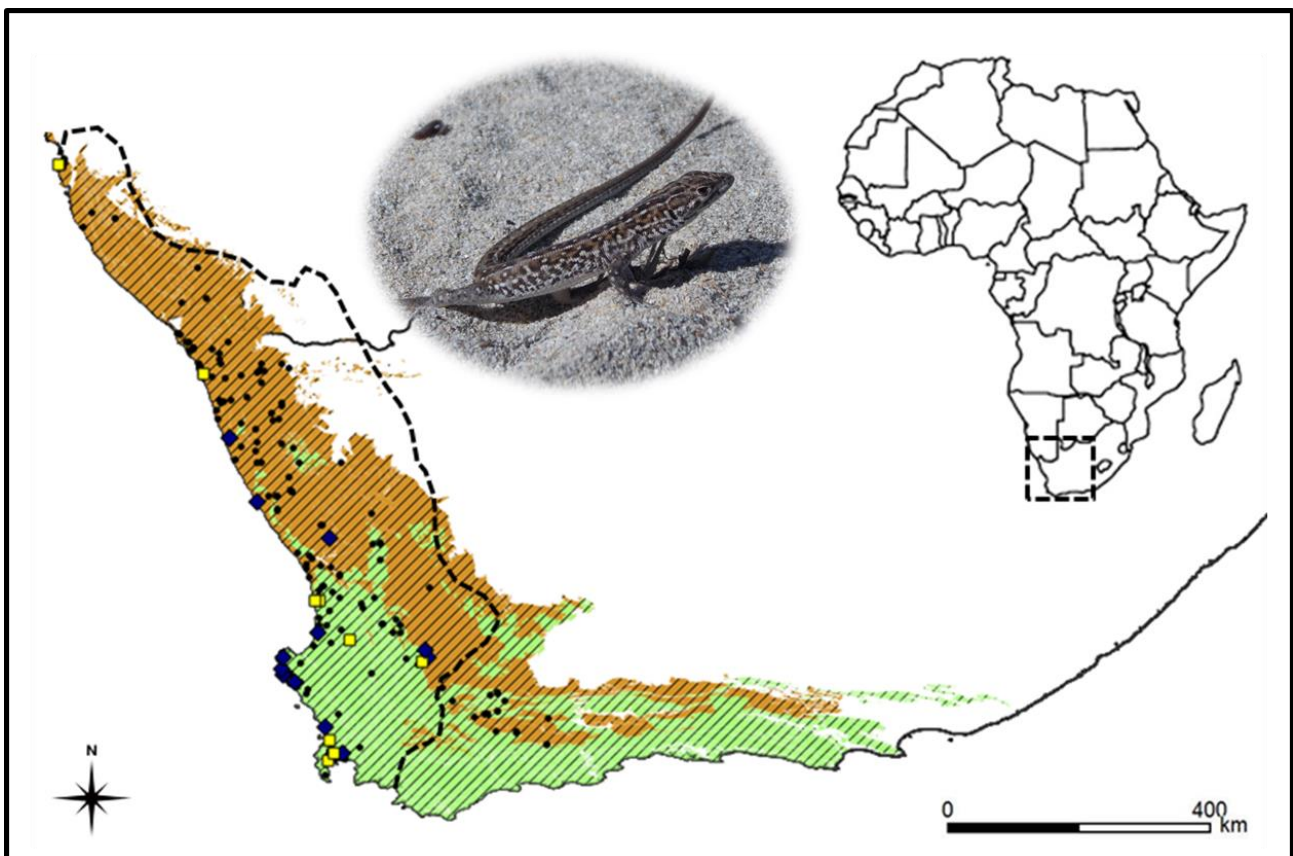

Figure 2.1: Point localities records (black) of *Meroles knoxii* (insert) along the west coastal margin of southern Africa (map insert). Sites sampled for previous studies (yellow) and this study (blue) are shown within the distribution (Table 2.3). Greater Cape Floristic Region (GCFR, diagonal stripes) comprises the Succulent Karoo (brown) and Fynbos (green) biomes (Mucina *et al.*, 2006). The approximate winter-rainfall zone occurs west of dotted line (Schulze, 2007, Stowe & Sealy, 2015).

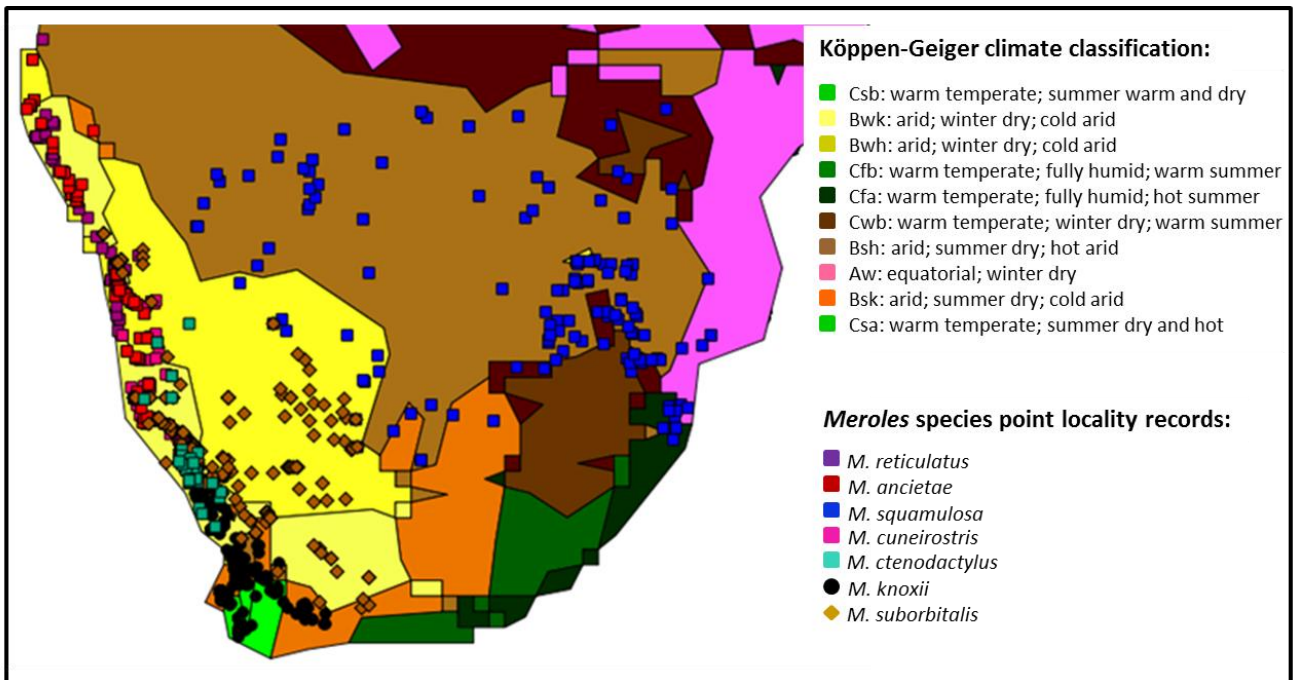

Figure 2.2: Contemporary point locality records for all species of *Meroles* (excluding *M. micropholidotus*) presented on the common climate classification of Köppen-Geiger, showing species occurring in arid/warm temperate regions, with the exception of *M. knoxii* (black dots).

2.2.2 DNA Extraction, Amplification and Sequencing

DNA was extracted from tail tips acquired in the field ($n=32$) and from SANBI Reptile tissue bank ($n=36$) using standard salt extraction method (©Vieites, Berkeley USA, Appendix 1.1). Standard PCR was performed to amplify three molecular markers, 2 mitochondrial markers (mtDNA) and one nuclear marker (nDNA). Mitochondrial markers; NADH sodium dehydrogenase subunit 4 (ND4) and 16S rRNA were used, as well as the nuclear marker, recombination activating gene 1 (RAG1) for a subset of the samples ($n=33$). Primer pairs listed in Table 2.1. Amplification of all genes were carried out using $\sim 20\text{--}60\text{ng}/\mu\text{l}$ genomic DNA in a $25\mu\text{l}$ PCR reaction which contained a thermophilic buffer (50mM NaCl, 50mM Tris-HCl pH 9.0), 5.0mM MgCl_2 , 0.2 μM of each primer, 200 μM dNTPs, and 1.25 U/0.25 μl Taq polymerase (GoTaq®DNA Polymerase, Promega). Cycling conditions differed for each gene region (Table 2.1). PCR products were visualised on an ethidium bromide stained 1% agarose gel using gel electrophoresis for 25 minutes. Sequencing was implemented by Macrogen Inc. (Seoul, Korea) using the forward primer, and aligned using Geneious version 4.8.5 using the cost matrix Clustal W version 2 (Larkin *et al*, 2007).

Table 2.1: Primer pairs and PCR cycling conditions of the two mtDNA and one nuclear marker used to amplify the three gene regions.

Gene region	Primer name	Forward / Reverse	Primer sequence	Tm	Primer source	Denaturing	Annealing	Final extension
16S	16Sa	Fwd	5' CGC CTG TTT ATC AAA AAC AT 3'	54	Palumbi <i>et al.</i> 1996	94°C	48-52°C	72°C
	16Sb	Rev	5' CCG GTC TGA ACT CAG ATC ACG T 3'	62.3		03:45	45s (25cycles)	1min
ND4	F3	Fwd	5' TGA CTA CCA AAA GCT CAT GTA GAA GC 3'	60.9	Arèvalo <i>et al.</i> 1994	94°C	48-54°C	72°C
	R4	Rev	5' CAT TAC TTT TAC TTG GAT TTG CAC C 3'	58.9		04:30	45s (35cycles)	45s
RAG1	F0	Fwd	5' GAA AAG GGC TAC ATC CTG G 3'	55.7	Mayer & Pavlice v 2007	94°C	48-56°C	72°C
	R1	Rev	5' AAA ATC TGC CTT CCT GTT ATT G 3'	56.1		05:30	45s (40 cycles)	30s

2.2.3 Phylogenetic Analysis

Phylogenetic analysis was conducted using all available sequences of *Meroles knoxii*, including 49 sequences from GenBank (Table 2.3). A partition homogeneity test (Farris *et al.*, 1994, 1995) was conducted in PAUP* v 4.0b10 (Swofford, 2002) and showed no conflict between the two mitochondrial markers nor between the combined mitochondrial with the nuclear marker (nDNA: $p=0.01$; mtDNA: $p = 0.004$). Several taxa were used as outgroup taxa (see Edwards *et al.* 2012), including all species of the *Meroles* genus (except *M. micropholidotus*), two species of *Ichnotropis* (*I. capensis*, *I. bivittata*); *Tropidosaura* (*T. gularis*, *T. montana*) and *Australolacerta* (*A. rupicola*, *A. australis*).

A phylogenetic tree was constructed using Bayesian Inference (MrBayes v2.3.3; Ronquist & Huelsenbeck, 2003). Phylogenetic trees were first constructed by analysing gene regions separately (16S; 476bp; $n=83$, ND4; 834bp; $n=93$, RAG1, 996bp, $n=26$). Afterwards, gene fragments were concatenated providing a total of 1310bp ($n=80$) for mtDNA analysis and 2306bp ($n=26$) for combined mtDNA and nDNA analyses. Several phylogenetic analyses were conducted on the concatenated dataset; (1) all *M. knoxii* with only *M. suborbitalis* and *M. anchietae* as outgroup taxa, (2) all *M. knoxii* with the all *Meroles* species as outgroup taxa, (3) *Meroles knoxii* as in-group and several lacertid species as outgroup taxa (see Edwards *et al.*, 2012).

All Bayesian sequence alignment files were analysed using jModeltest v2.1 (Posada, 2008) to estimate the evolutionary best-fit models of nucleotide substitution. The following models were revealed as the AIC (Akaike Information Criterion) best fit for 16S (TrN+I+G) ND4 (TIM2+I+G) and RAG1 (TIM2+G). These models were then used to identify the number of rate categories for each partition (Nst = 6, all molecular markers). For Bayesian analysis twenty million generations were

performed for two parallel runs of four chains of Markov Chain Monte Carlo (MCMC) algorithms, with trees sampled every 1000 generations.

Tracer v 1.5 (Rambaut & Drummond, 2007) was used to ascertain the number of generations to discard as burn-in by examining the effective sample sizes (ESS) of all parameters which were ≥ 200 . A 50% majority rule tree was constructed with the burn-in excluded using the “sumt” command in MrBayes, and nodes with ≥ 0.95 posterior probability were considered supported. A partitioned maximum likelihood (ML) analysis was run (RAxML v.7.2.8; Stamatakis, 2006) using the same partitions utilized for the Bayesian analysis using the GTR+I+G model of evolution with 1000 bootstrap replicates. Bootstrapping of ≥ 75 was considered supported. The level of genetic diversity between and within the clades was investigated using sequence divergences estimated utilizing net uncorrected p-distances in MEGA v.5 (Tamura *et al.*, 2011).

2.2.4 Population genetics

Population level analyses were carried out on the two mitochondrial markers of *M. knoxii* acquired from 22 sites (Table 2.3). A haplotype network was constructed for all data of both mtDNA markers using NETWORK v. 4.613 (www.fluxus-engineering.com; Bandelt *et al.*, 1999; Forster *et al.*, 2001; Polzin, 2003) to identify the number of haplotypes, whether there were haplotypes shared between sites, and provide a qualitative representation of haplotype distribution across the sampled populations. Estimations of haplotype diversity (h) and nucleotide diversity (π) for all individuals from each clade were estimated using Arlequin v3.11 (Excoffier *et al.*, 2005). A 95% connection limit was identified using TCS v1.21 (Clement *et al.*, 2000) to determine whether haplotype grouped together or separately.

To examine spatial genetic structure, a Spatial Analysis of Molecular Variance (SAMOVA) was applied to examine which groupings maximize the F_{CT} value -the variance among groups relative to the total variance (SAMOVA v.2.0, Dupanloup *et al.*, 2002; Fitzpatrick, 2009). A SAMOVA incorporates a simulated annealing procedure to maximize the total genetic variance based on differences between groups of populations. SAMOVA's were conducted on the two mtDNA markers separately, the mtDNA markers combined and the nDNA and mtDNA dataset combined. Independent runs with different values of K ($K = 2-15$) were carried out for each dataset, with 100 random initial conditions and 1000 iterations. Furthermore, the southern clade (see Results) was analysed separately to examine whether fine scale population differentiation could be detected.

A Mantel test was performed using Alleles in Space (AIS; Miller, 2005) to analyse the “isolation by distance” of the southern clade individuals by plotting the genetic similarity (distance) among individual pairs as a function of geographic distance between those pairs (Slatkin 1993, Rousset 1997, Hutchinson & Templeton 1999). Both mtDNA markers were analysed separately and then together for the entire data set.

2.2.5 Morphology (body size)

Snout-vent-length (SVL) of *M. knoxii* individuals sampled during fieldwork and from previous studies (Edwards *et al.* 2012) was used to examine whether body size differed along the north-south axis of the distribution range. A one-way ANOVA with clade membership as fixed factor was used to examine whether body size differed significantly between the clades identified (see Results). First, SVL measurements of males and females were compared for the entire data set, to investigate whether body size differed between sexes, which could bias results. Then, SVL's were compared between clade groups. As SVL data were not available for the relatively small central clade, data for the northern and southern clade were compared to examine whether the northern clade individuals are significantly larger than southern clade individuals.

2.3 RESULTS

2.3.1 Phylogenetic Analyses

Bayesian and maximum likelihood analyses consistently retrieved *M. knoxii* as a well-supported monophyletic group for the concatenated dataset of three markers (Fig. 2.3). Other analyses (see Methods) revealed the same topologies with similar support values (not shown). Within the species, three clades were identified that correspond to geographically separated groups. Firstly, the northern clade was the most widespread and occurs from the south of Namibia along the west coast of South Africa in the Northern Cape Province until Groenriviermond, with some specimens from the Lutzville area and southern Tankwa. The northern clade occurs exclusively in the Succulent Karoo biome. The geographically restricted central clade occurs along the west coast to the north of the Western Cape Province in the fynbos biome. Lastly, the southern clade, relatively less widespread than the northern clade, occurs from the Elandsbay area along the West Cape Coast to the south of Cape Town (Fig. 2.3 & Fig.2.4). Sequence divergence (uncorrected p -distances) between identified clades was estimated for each mitochondrial molecular marker (Table 2.2b). Southern African generic lacertid divisions are typically 16S: 7.57±1.38%, ND4: 21.21±1.33%, RAG1: 4.07±0.54% (Edwards *et al.*, 2012). The same study indicated species level sequence divergence between *A. australis* and *A. rupicola* are 16S:9.55±2.08%; ND4:22.69±1.60%; RAG1:3.74±0.76. Therefore, this rough measure of species differentiation shows no species level differences between the three genetic clades identified in *M. knoxii*.

Table 2.2: a) Haplotype (h) and nucleotide (π) diversities of 16S (top) and ND4 (centre) for northern, central and southern clades (left of matrix). b) Net sequence divergences (p-distances) between clades of *Meroles knoxii* for 16S (top), ND4 (centre) and RAG1 (bottom) markers below the diagonal and standard errors above the diagonal and within clade sequence divergence on the diagonal (shaded grey).

a)			b)		
h	π	16S	Northern	Central	Southern
0.55±0.110	0.004±0.0030	Northern	0.004±0.002	0.005	0.006
0.33±0.22	0.0067±0.0049	Central	0.01	0.007±0.002	0.005
0.77±0.03	0.0035±0.0025	Southern	0.013	0.014	0.004±0.002
h	π	ND4	Northern	Central	Southern
0.95±0.03	0.01239±0.0065	Northern	0.013±0.002	0.008	0.009
0.96±0.08	0.0058±0.0036	Central	0.078	0.005±0.002	0.009
0.83±0.04	0.0058±0.0032	Southern	0.077	0.078	0.006±0.001
		RAG1	Northern	Central	Southern
		Northern	0.007±0.001	0.001	0
		Central	0.001	0.004±0.002	0.001
		Southern	0	0.001	0.003±0.001

2.3.2 Population genetics

For the two mitochondrial markers, 16S and ND4, haplotype (h) and nucleotide (π) diversities were estimated for the three clades separately; northern, central and southern (Table 2.2a). The 95% confidence intervals show that the northern and central clade haplotype diversities are not significantly different, whereas the southern clade haplotype diversity is significantly higher than the other clades. Nucleotide diversity values were not significantly different for any of the clades. The haplotype networks revealed a total of 14 haplotypes for 16S and 43 haplotypes for ND4. A 95% connection limit did not group clades separately for 16S, but did group clades separately for ND4 (Fig. 2.5).

The SAMOVA analysis revealed three distinct genetic groups for both the combined mtDNA and ND4 analysis as among group variation reached a plateau at $K=3$; showing that ~62-64% of the genetic variation could be explained by grouping the samples in these three groups (Fig. 2.6a). The three groups reflect the clades identified by the phylogenetic analysis. Furthermore, the separate analysis of the southern clade showed no genetic structure, suggesting that sample sites within this clade can be considered a single population (Fig. 2.6b).

The Mantel test indicated that the geographical and genetic distance matrices for sampled sites of the southern clade were significantly positively correlated for both combined molecular markers and separately analysed 16S and ND4 (Fig. 2.7, mtDNA: $p<0.01$, $r=0.51$; 16S: $p<0.01$, $r=0.09$; ND4: $p<0.01$, $r=0.33$). This trend denotes that isolation by distance does occur within the southern genetic population of *M. knoxii*.

2.3.3 Morphology (*body size*)

Body size means (Male SVL: $46.63 \pm 6.23SD$, Female SVL: $47.42 \pm 5.89SD$) did not differ significantly between males ($n=81$) and females ($n=63$) ($F(1,103) = 0.595$, $p = 0.442$). Therefore, no body size differences were detected given these data. However, body size did differ significantly between the northern (SVL: 52.96 ± 5.16 ; $n=30$) and southern clades (SVL: 45.09 ± 5.2 ; $n=105$) for the combined sexes, with SVL being larger for the northern group ($F(1,135)=52.739$, $p<0.01$; Fig. 2.8).

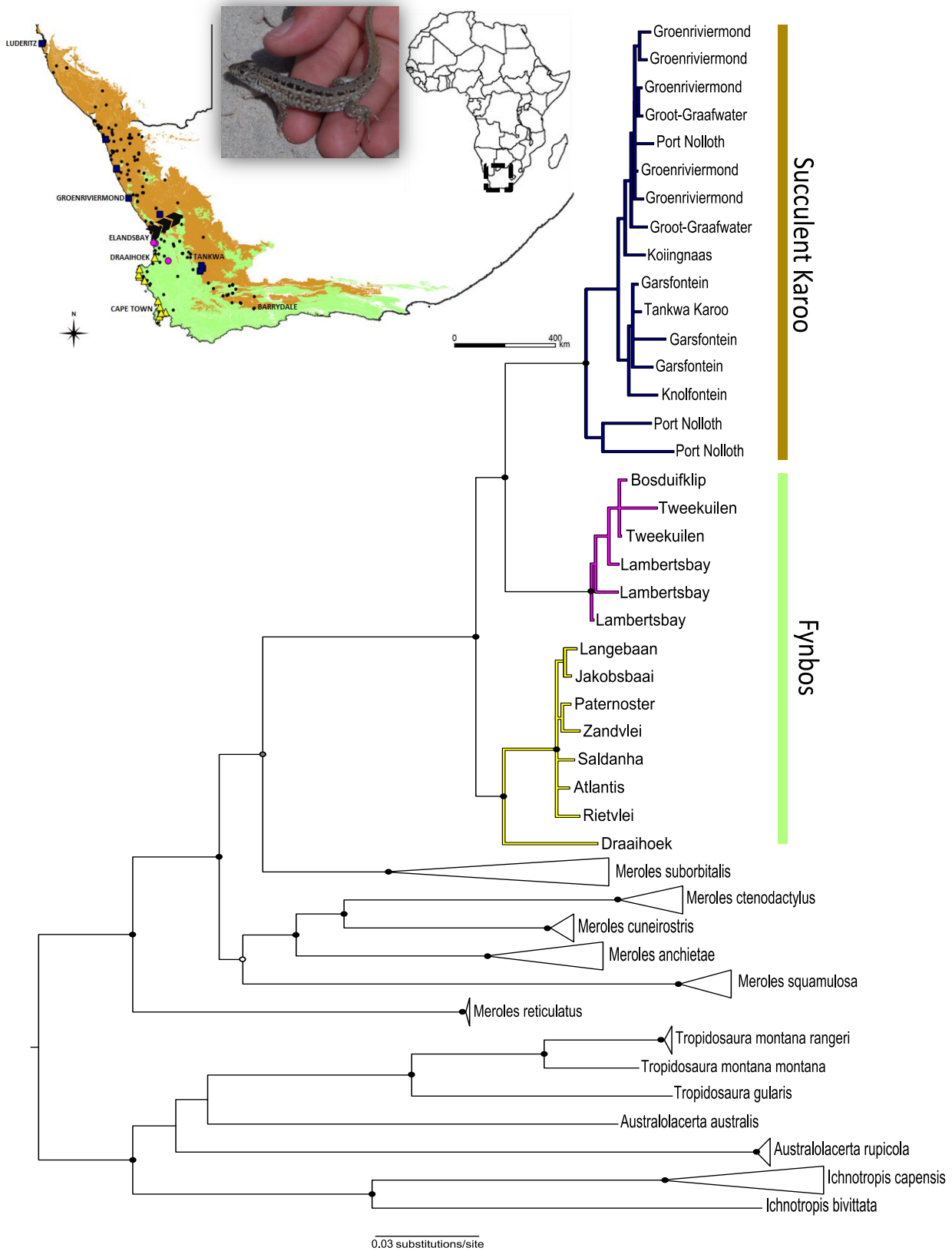

Figure 2.3: Phylogenetic relationship of *Meroles knoxii* compared to several southern Africa outgroup lizards (Lacertidae: Eremiadini) estimated using two mitochondrial (16S, ND4) and one nuclear (RAG1) marker. Bayesian topology used to show relationships with Bayesian inference (posterior probability ≥ 0.95) and maximum likelihood (bootstrap values $\geq 0.75\%$). Support indicated as follows: both analyses (black circles), Bayesian inference (grey circles), Maximum likelihood (white circles), unsupported nodes (no circles). Map inset: Phylogenetic analysis revealed three clades that correspond to geographically distinct groups; a northern clade (blue squares), central clade (pink dots) and southern clade (yellow triangles). Black dots indicate the point localities of *M. knoxii*. See Fig. 2.4 for details.

Table 2.3: The localities used for phylogenetic and population genetic (only *Meroles knoxii*) analyses. The sample size (N), the province in which the locality is situated, GPS coordinates and the number of individuals sequenced for each gene. Data acquired from previous studies, i.e. Lamb & Bauer (a, 2003), Edwards *et al.* (b, 2012), Engleder *et al.* (c, 2012), Makokha *et al.* (d, 2007) and samples from South African National Biodiversity Institute (e, SANBI) Reptile Tissue Bank are included. Unmarked locality tissue was taken in the field. Abbreviations: WC=Western Cape, NC=Northern Cape, EC=Eastern Cape, KZN=KwaZulu-Natal, PNR=Private Nature Reserve.

Sample site	Species	Locality	N	Country	Province/Region	Coordinates	16S rRNA	ND4	RAG1
1	<i>Meroles knoxii</i>	Luderitz ^c	1	Namibia	IlKaros Region	29°49'16"S 17°04'48"E	1		
2	<i>Meroles knoxii</i>	Port Nolloth ^{a,b}	7	South Africa	NC	29°15'27"S 16°54'38"E	5	2	
3	<i>Meroles knoxii</i>	Draaihoek ^e	3	South Africa	WC	32°28'56"S 18°20'09"E	1	1	1
4	<i>Meroles knoxii</i>	Tweekuilen ^b	5	South Africa	WC	32°35'17"S 18°43'44"E	2	2	1
5	<i>Meroles knoxii</i>	Tankwa Karoo ^e	14	South Africa	WC	32°47'27"S 19°42'55"E	5	6	3
6	<i>Meroles knoxii</i>	Koiingnaas ^e	6	South Africa	NC	30°03'49"S 17°13'49"E	2	3	1
7	<i>Meroles knoxii</i>	Knolfontein PNR ^b	3	South Africa	WC	32°50'59"S 19°38'32"E	1	1	1
8	<i>Meroles knoxii</i>	Groot-Graafwater ^e	6	South Africa	NC	31°18'06"S 18°29'24"E	2	2	2
9	<i>Meroles knoxii</i>	Groenriviermond ^e	14	South Africa	NC	30°51'30"S 17°34'33"E	4	5	5
10	<i>Meroles knoxii</i>	Driftsands NR ^e	2	South Africa	WC	33°59'30"S 18°39'11"E	1	1	
11	<i>Meroles knoxii</i>	Zandvlei NR ^{b,e}	17	South Africa	WC	34°05'34"S 18°28'09"E	7	9	1
12	<i>Meroles knoxii</i>	Garsfontein ^e	15	South Africa	WC	32°42'54"S 19°41'17"E	7	7	1
13	<i>Meroles knoxii</i>	Phillipi ^{b,e}	12	South Africa	WC	34°00'06"S 18°31'54"E	5	7	
14	<i>Meroles knoxii</i>	Rietvlei NR ^{b,e}	12	South Africa	WC	33°50'20"S 18°29'29"E	4	8	
15	<i>Meroles knoxii</i>	Noup ^e	2	South Africa	NC	30°03'47"S 17°13'44"E	1	1	
16	<i>Meroles knoxii</i>	Bosduifklip Farm ^{b,e}	3	South Africa	WC	32°05'40"S 18°21'00"E	1	1	1
17	<i>Meroles knoxii</i>	Saldanha	11	South Africa	WC	33°00'43"S 17°54'10"E	5	5	1
18	<i>Meroles knoxii</i>	Jakobsbay	7	South Africa	WC	32°56'48"S 17°53'13"E	3	3	1
19	<i>Meroles knoxii</i>	Paternoster	27	South Africa	WC	32°48'28"S 17°53'33"E	13	13	1
20	<i>Meroles knoxii</i>	Atlantis	12	South Africa	WC	33°40'05"S 18°26'03"E	5	6	1
21	<i>Meroles knoxii</i>	Langebaan	11	South Africa	WC	33°06'51"S 18° 3'01"E	5	5	1
22	<i>Meroles knoxii</i>	Lambertsbay ^{b,e}	10	South Africa	WC	32°04'59"S 18°18'00"E	3	5	2
23	<i>Meroles suborbitalis</i>	Kareeburg ^b	3	South Africa	NC	32°52'12"S 18°31'48"E	1	1	1
24	<i>Meroles anchietae</i>	Kunene ^b	3	Namibia	Kunene	18°54'36"S 11°55'12"E	1	1	1
25	<i>Meroles anchietae</i>	Gobabeb ^b	3	Namibia	Erongo	24°26'24"S 15°1'12"E	1	1	1
26	<i>Meroles cuneirostris</i>	Gobabeb ^b	6	Namibia	Erongo	24°26'24"S 15°1'12"E	2	2	2
27	<i>Meroles reticulatus</i>	Swakopmund ^b	5	Namibia	Erongo	23°40'48"S 14°30'E	2	1	2
28	<i>Meroles ctenodactylus</i>	Hondeklipbaai ^b	6	South Africa	NC	31°56'24"S 17°13'48"E	2	2	2
29	<i>Meroles squamulosus</i>	Venetia ^b	1	South Africa	LMP	23°44'24"S 29°19'48"E		1	
30	<i>Meroles squamulosus</i>	Rooipoort ^b	2	South Africa	NC	28°38'02"S 24°16'51"E	1	1	
31	<i>Ichnotropis bivittata</i>	Humpata ^b	3	Angola	Huila	15°1'12"S 13°25'48"E	1	1	1
32	<i>Ichnotropis capensis</i>	Tsumkwe ^b	1	Namibia	Otjozondjupa	20°32'24"S 19°43'12"E	1		
33	<i>Ichnotropis capensis</i>	Kosi Bay ^b	2	South Africa	KZN	27°3'36"S 32°49'12"E		1	1
34	<i>Tropidosaura montana rangeri</i>	Sterkstroom ^b	6	South Africa	EC	32°23'24"S 26°18'36"E	2	2	2
35	<i>Tropidosaura montana montana</i>	Upper Kromme River ^b	3	South Africa	EC	23°2'19"S 29°25'49"E	1	1	1
36	<i>Tropidosaura gularis</i>	Kammanassie ^b	3	South Africa	WC	34°22'48"S 22°53'24"E	1	1	1
37	<i>Vhembalacerta rupicola</i>	Bergplaat ^b	6	South Africa	Limpopo	34°8'30"S 24°48'41"E	2	2	2
38	<i>Australolacerta australis</i>	Grootwinterhoek ^b	3	South Africa	WC	34°55'48"S 19°6'36"E	1	1	1

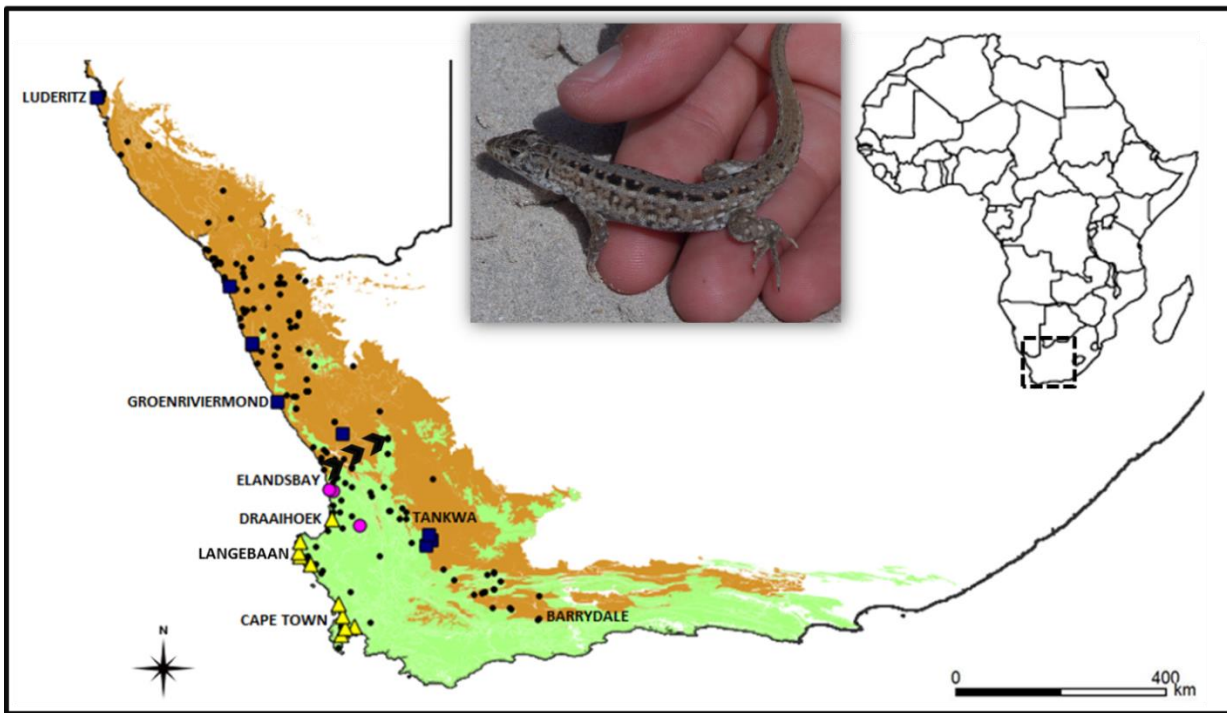

Figure 2.4: Geographic distribution of the three clades of *Meroles knoxii* (inset) identified by phylogenetic inference (Fig. 2.3). Relevant sites are indicated on the map, with the northern clade (blue squares) occurring predominantly in the Succulent Karoo Biome (brown) and the central (pink dots) and southern (yellow triangles) clades occurring in the Fynbos Biome (green). Chevrons indicate the Knersvlakte. Black dots indicate occurrence records of *M. knoxii*.

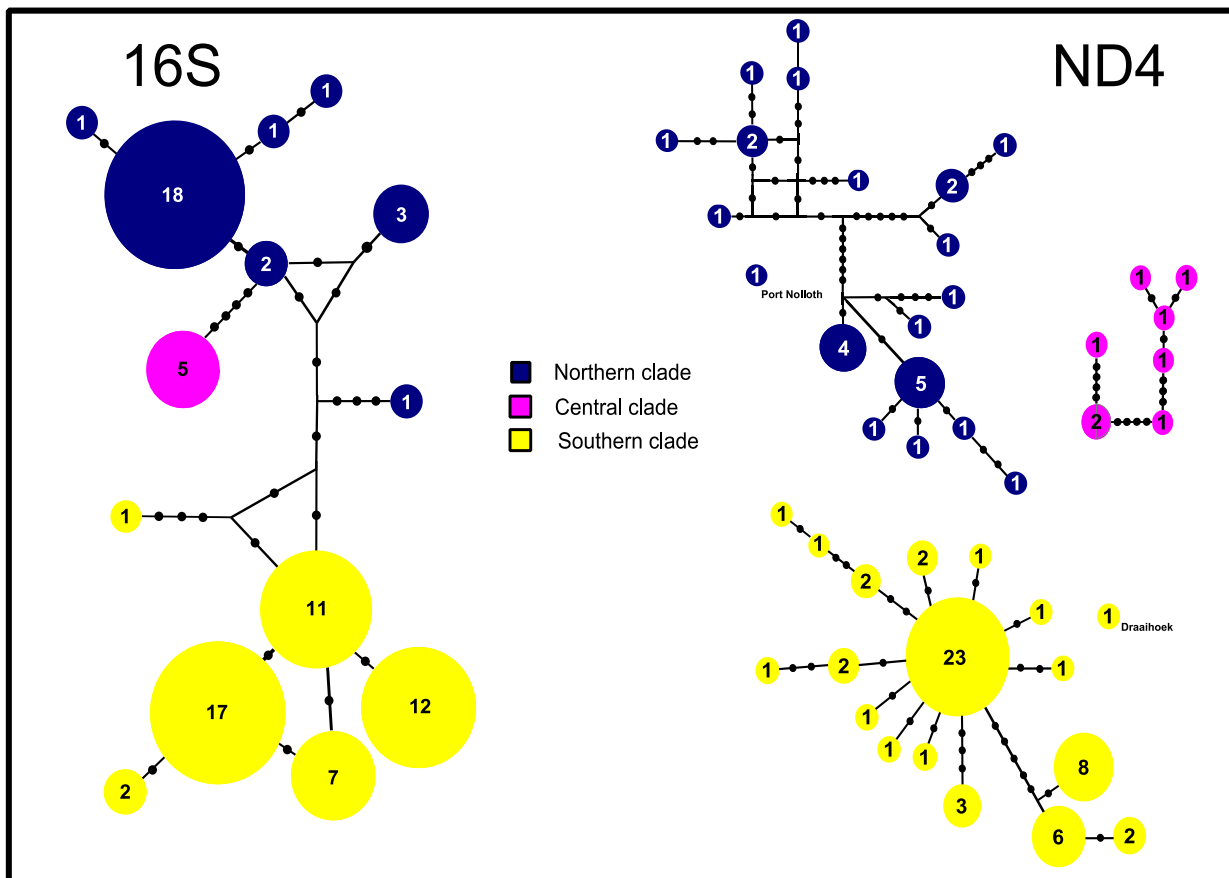

Figure 2.5: Haplotype networks of 16S (left) and ND4 (right) revealed 14 ($n=82$) and 43 ($n=95$) haplotypes for each marker, respectively. Circles show each haplotype, with the size of the circle indicating the frequency, and these are colour coded to show which haplotypes occur in the northern clade (blue), central clade (pink) and southern clade (yellow). A 95% connection limit did not group clades separately for 16S, but did group clades separately for ND4, including ND4 haplotypes from Port Nolloth (northern clade) and Draaihoek (southern clade). The black dots on the haplotype connections indicate number of mutations between those haplotypes.

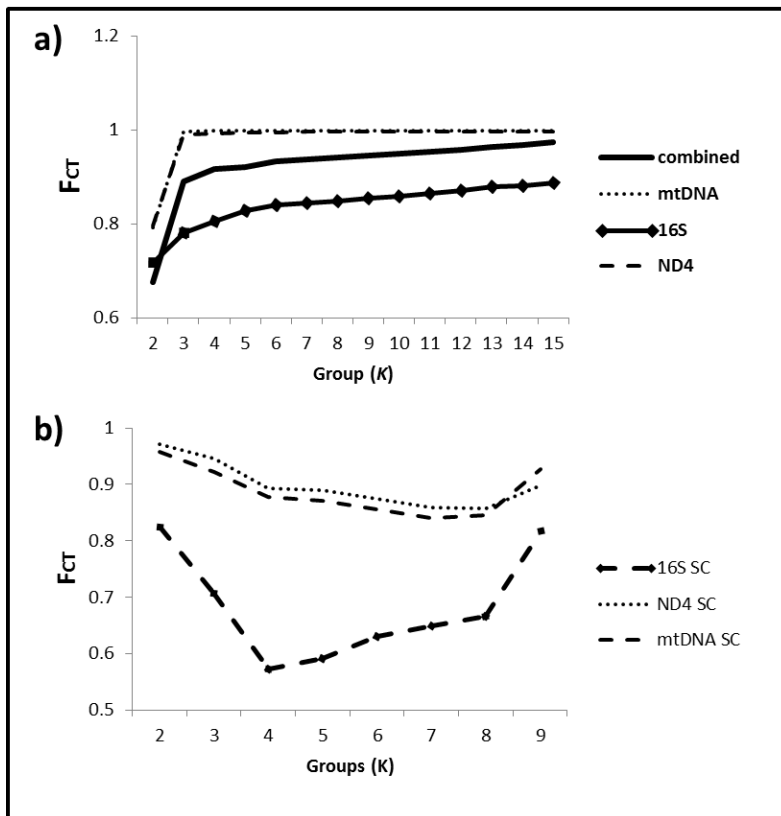

Figure 2.6: a) SAMOVA results indicate three genetic groups which reflect the clades identified by the phylogenetic analyses; northern, central and southern. Among group variation plateaus for combined mtDNA and separately analysed 16S and ND4 analyses at K=3. b) SAMOVA analyses show no among group variation in southern clade for combined mtDNA data, or separately analysed 16S and ND4 analyses, indicating a lack of genetic structure within this group of sampled data.

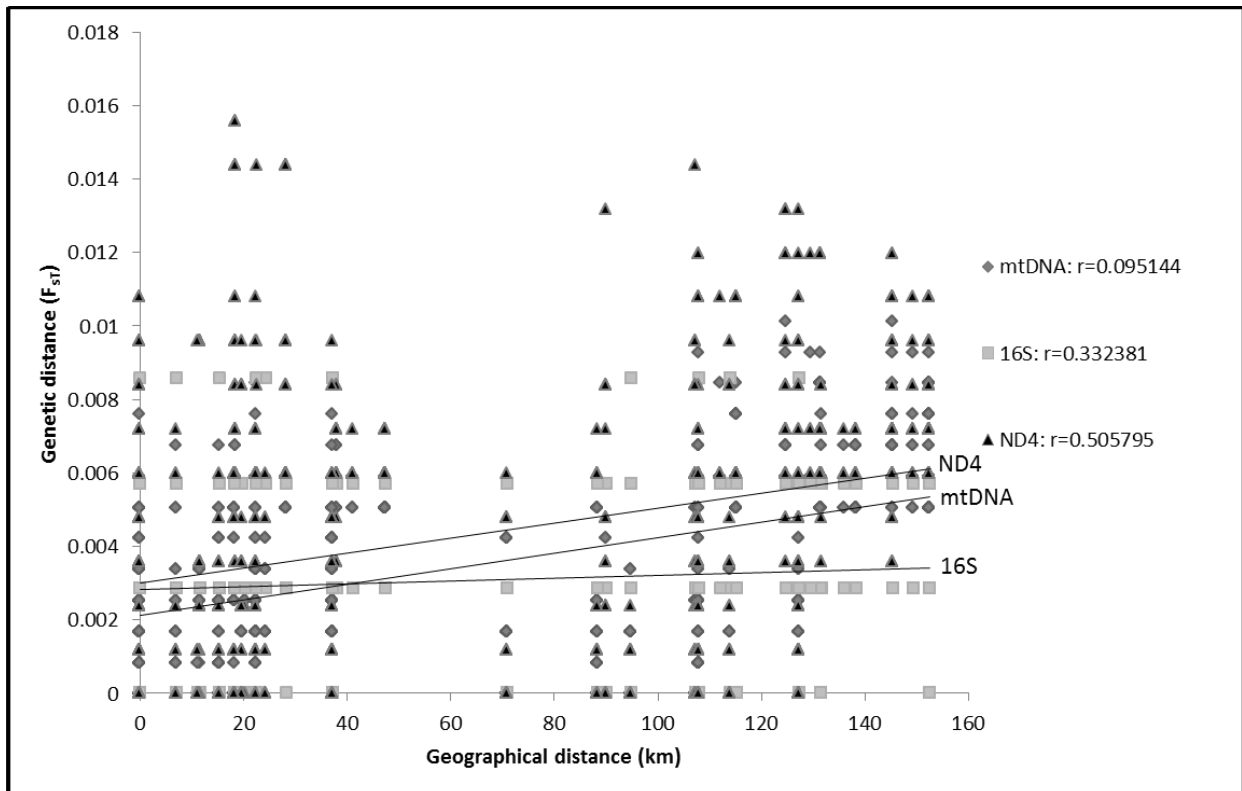

Figure 2.7: Mantel test indicates a significant positive correlation between geographic distance (x-axis; kilometers) and genetic distance (y-axis; F_{ST}; p<0.01) for the combined mtDNA data (diamonds) and separately analysed 16S (squares) and ND4 (triangles) data.

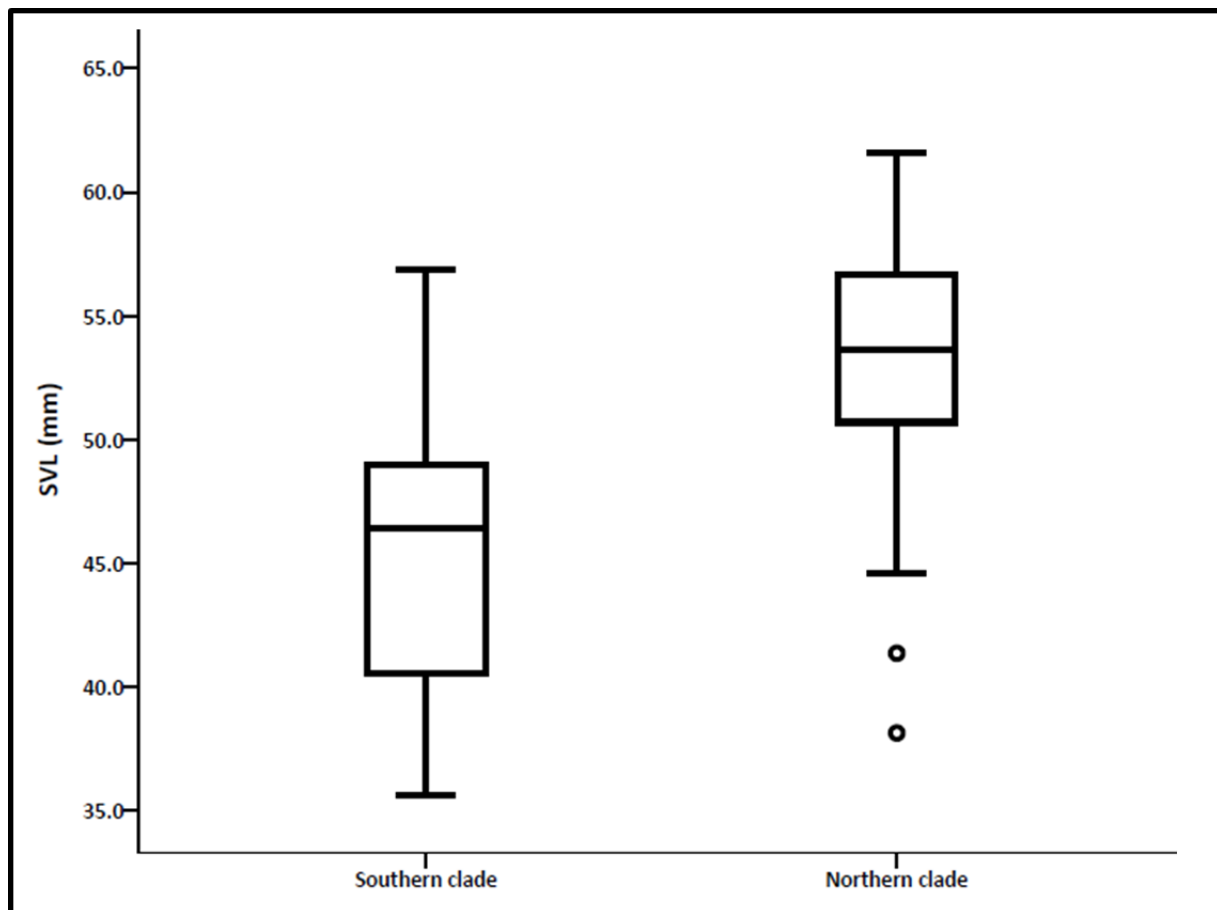

Figure 2.8: Mean snout-vent-length (millimetres) of northern and southern clades showing northern clade individuals (n=30) have a significantly larger body size than southern clade (n=105) individuals. Mean indicated as horizontal lines in boxes, boxes indicate variance around the mean, error bars \pm s.e.m, northern clade data shows two outliers (circles).

2.4 DISCUSSION

Phylogenetic and population genetic analyses show at least three well supported, distinct clades for *M. knoxii* that occur allopatrically along the west coast of southern Africa (Fig. 2.3 & Fig. 2.4), consistent with the pattern of high intraspecific lineage turnover in the western GCFR (Tolley *et al.*, 2006, 2009; Price *et al.*, 2007; Linder *et al.*, 2010; Barlow *et al.* 2013). Phylogeographic patterns of mammals and reptiles in the GCFR suggest environmental fluctuations during the Plio-Pleistocene could be responsible for fragmenting previously continuous distribution ranges (Matthee and Flemming, 2002; Swart *et al.* 2009; Linder *et al.*, 2010; Daniels *et al.*, 2010). Considering the approximate origination of *M. knoxii* (~20mya), this patterns could have arisen due to historic environmental changes.

Aridity of the west coastal margins of southern Africa originated in the late Cenozoic (Partridge, 1993; Tankard *et al.*, 1978). The advent of the Benguela Current (ca. 10 Ma) is considered a major contributing factor to aridification of the west coast and this current is still intimately associated with hyper-arid climates today (Siesser, 1978, 1980). Several phylogenetic studies have identified Miocene desertification as a possible driver in Australian lizard diversification (Rabosky *et al.*, 2007; Couper *et al.*, 2008; Shoo *et al.*, 2008; Powney *et al.*, 2010). As southern Africa and Australia underwent similar aridification cycles during past climatic fluctuations, aridification as a

diversification driver in southern African lizards is possible. In fact, the west coast aridification has been implicated in the historic range expansion of several South African lizards due to availability of favourable open habitat (Swart *et al.*, 2009; Engelbrecht *et al.*, 2013). Given the occurrence of the majority of *Meroles* species on the west coastal margin of Namibia (Fig. 2.2), *M. knoxii* could have dispersed southwards due to the availability of novel open habitat caused by the aridification associated with the origination of the Benguela Current ~10Mya. Climatic amelioration during the Pliocene caused sea level transgressions (Partridge, 1990). The Langebaan region, situated between the southern and central clades, experienced rising sea-levels from the Late Miocene (~11.2mya; 30m above mean sea level, MSL) to the Late Pliocene (~1.8mya, 90m, 50m, and 20m above MSL). These sea level changes could have disrupted the contemporary continuous distribution range of *M. knoxii*, causing vicariance of these clades sometime between the late Miocene to late Pliocene north and south of the Berg River region (Fig. 2.9). The sea level transgression of the Berg River has been implicated as a possible historic dispersal barrier of semi fossorial skinks (Heideman *et al.*, 2011; Engelbrecht *et al.*, 2013), suggestion that a psammophilic lizard such as *M. knoxii*'s could also experience this drainage system as a dispersal barrier, historically, currently or both. However, fine scale sampling of this area is required as the phylogeny and haplotype network suggest the possible occurrence of a fourth clade in the Draaihoek area (Fig. 2.3, Fig. 2.5 & Fig. 2.9). The Olifants River occurs between the northern and central clades (Fig. 2.9). Although sea level transgressions do not appear to have affected the region of this drainage system to the same extent as the Berg River region, it could potentially pose as a barrier of dispersal for this lizard. However, considering the Orange River does not appear to cause vicariance within the under sampled northern clade (Fig. 2.9), it is problematic to suggest the Olifants River could be responsible for historic vicariance between the northern and central clades. The Knersvlakte, which appears to occur between the northern and central clades (Fig. 2.4) is thought to present a barrier to rupicolous lizards and hinder dispersal due to substrate affinity (Matthee & Flemming, 2002; Swart *et al.*, 2009; Tolley *et al.*, 2014). Although, this supposed geographic barrier is more likely to act as a dispersal corridor for a psammophilic lizard. As the extent of the northern and central clade is not known, any factors potentially contributing to their phylogeographic occurrence is uncertain. Yet, as the Knersvlakte has been implicated as a barrier for other reptile species, perhaps substrate is not the only factor contributing to the potential vicariance observed. Other factors could include the climatic niche availability or lack of appropriate shelter in the Knersvlakte, especially for a sit-and-wait forager such as *M. knoxii*.

The northern clade occurs in the arid temperate Succulent Karoo biome and the central and southern clades occur in the Mediterranean Fynbos biome. The phylogeny suggests that the first cladogenic event occurred between the southern clade and central/northern clades, with the central and northern clades diverging some time afterwards (Fig. 2.3 & Fig. 2.4). The phylogenetic structure does not correspond well with the current geographic distribution of these biomes as the

first divergence occurred between the southern and central clade situated in the Fynbos Biome and the second divergence between the northern and central clade occurring in the Succulent Karoo and Fynbos biomes, respectively. However, past climatic fluctuations, especially since the

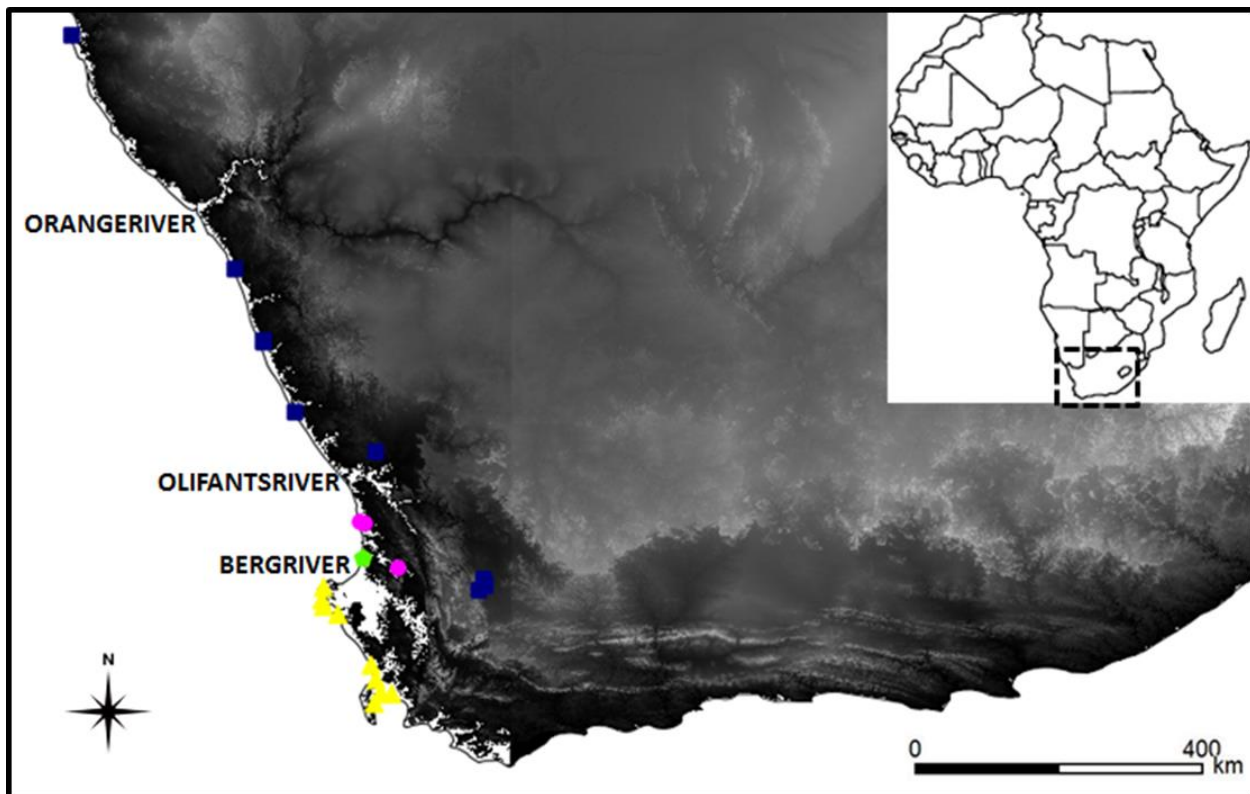

Figure 2.9: Digital elevation model of the sea level transgression experienced during the late Pliocene (90m MSL). The northern clade (blue) and central clade (pink) are bisected by the Olifants River, whilst the central clade and southern clade (yellow) are bisected by the Berg River to an even greater extent. One exception is the Draaihoek specimen (green), which forms part of the southern clade, but groups separately in the phylogeny (see Fig. 2.3).

Pleistocene, has been implicated in shifting the boundaries of these two biomes on a north-south axis (Midgley & Roberts, 2001; Midgley *et al.*, 2001), more recently with the Succulent Karoo biome displacing the Fynbos biome from north to the present south for the past 18kyr (Midgley *et al.*, 2005).

As the geographic placement of the three clades follow a north, central and southern pattern on a north-south axis, historic biome shifts could have contributed to the current geographic placement of clades observed for *M. knoxii*. In addition, as contemporary biome distributions do not correlate with the observed phylogeographic occurrence, the biome classification might be too broad a pattern. For instance, vegetation types, whether their density or occurrence, or even thermal microhabitats occurring within these biomes might be a more suitable pattern of comparison as microhabitat specialization has been implicated in the rapid radiation of southern African lacertids (Edwards *et al.*, 2012).

Given the northern, central and southern allopatric placement of clades, the climatic gradient could well have influenced and perhaps maintained the phylogeographic occurrence of these clades.

Evolutionary branching occurs in these spatially structured populations along an environmental gradient, especially if the gradient is of intermediate slope, i.e. the changes in temperature, humidity or soil nutrients are gradual. However, when gradients are too shallow, selection pressures are not strong enough to drive divergence and speciation. In contrast, if gradients are too steep, selection is strong and prevents populations from spreading to unoccupied areas (Gavrilets & Losos, 2009). Although climatic gradients, both temperature and rainfall, does occur on the west coast, the slope is unknown. However, given the north-south phylogeographic occurrence of these three clades, it is conceivable that the climatic gradients could contribute to this pattern.

As hypothesized, if the temperature differential observed along the coast affects these lizards, body sizes should differ accordingly and it does appear to be the case. Individuals from the xeric northern clade are larger than mesic southern clade individuals (Fig. 2.8). Phenotypic diversification in this species might have been driven by local adaptation to temperature or rainfall differences along a selection gradient. Smaller body sizes could be advantageous in cooler climates as increased surface area to volume allows rapid heating and cooling and larger body sizes in warmer climates result due to relaxed body size selective pressure, giving rise to other benefits such as effective competition and predation (Shine & Madsen, 1996; Peters, 1983). However, Bergmann's rule is controversial for reptiles (Ashton & Feldman, 2003), even when considering species from the same genus (Angilletta & Dunham, 2003). Therefore, the body size trend observed could be due to the climatic gradients hypothesized or another environmental mechanism/s unknown. For *M. knoxii*, this possible local adaptation could be advantageous and increase fitness in arid and mesic environments for northern and southern populations, respectively. However, these results should be interpreted with caution, as the central clade was not sampled for body size.

Given the widespread distribution range of this species across a thermal gradient cryptic speciation was initially expected as thermal gradients have been associated with speciation (Doebeli & Dieckmann, 2003; Kawata *et al.*, 2007). However, sequence divergence values reflect intraspecific genetic differentiation between the three genetic clades (Table 2.2b), with values lower than what is commonly accepted as interspecific divergence for southern African lacertids (Edwards *et al.*, 2012). Yet, the strong population level structure and possible local adaptation of body size observed could suggest incipient speciation. In fact, *Anolis* lizards are thought to have diverged in body size first then structural microhabitat and finally microclimate (Williams, 1972; Losos, 2009).

Typically, species distribution models do not consider the potential of different populations within a species experiencing local adaptation to differing local environments. However, this is critical to estimating species responses to climate change as these responses might differ at small spatial scales and identifying these differences could be used to refine climate change response

predictions. Due to the possibility of local adaptation within each clade, fine-scale structure was investigated for the southern clade. No genetic structure was found for the southern clade, suggesting that it could be considered a single population when modelling climate change responses.

Isolation by distance was however, significantly positively correlated within the southern clade. Given the relatively small body size of this species in general (max SVL ~60mm), dispersal potential within the southern clade could be low, causing limited gene flow across the wide landscape and resulting in the isolation by distance pattern observed. Small scale gene flow would promote spatially structured populations which arise when individual movement occurs over short distances and ecological interactions are between localized individuals (Doebeli & Dieckmann, 2003; Kawata *et al.*, 2007). These local interactions could result in small differences that are not detectable on the scale sampled for this study. For instance, thermal traits might differ within this population as several thermal traits could be variable or conserved and identifying which traits are variable and which are conserved would serve to more accurately predict *M. knoxii*'s potential responses to climate change.

Given the diverse processes that likely influence the phylogeographic pattern of *M. knoxii*, climate change could strongly impact this system directly or indirectly through diverse mechanisms such as increasing temperatures and disruption of rainfall regimes. Furthermore, if these lizards are adapted to a winter rainfall system, dispersal to the eastern summer-rainfall area of southern Africa could be problematic; resulting in limited dispersal potential in response to climate change. With the Atlantic Ocean at the west of this species distribution range and the Cape Fold Mountains to the east and at the southern extent of the interior distribution, avenues of dispersal are limited. In addition, if these lizards are locally adapted to their xeric and mesic climates, adaptation to novel habitats might not match the rate of climate change proposed for the next century (Chapter 1).

Future studies should attempt to thoroughly sample the northern and central clades, not only increasing the number of sites sampled for this species, but also increased sample sizes per site to better gauge clade extent and identify historic and contemporary drivers associated with this pattern. In addition, the interior region should be thoroughly sampled which would aid in understanding the potential dispersal east in response to climate change. In addition, molecular dating of the clades could further aid our understanding of environmental factors that could've influenced the phylogeographic pattern observed in this study. To understand *M. knoxii*'s future responses to climate change it is imperative to understand the historic climates that could have influenced the phylogeographic patterns perceived today.

2.5 REFERENCES:

Ackerly, D.D., Schilck, D.W., Webb, C.O. 2006. Niche evolution and adaptive radiation: Testing

the order of trait divergence. *Ecology* **87**: 50–61.

- Angilletta, M. J., Niewiarowski, P. H., Navas, C. A., Angilletta Jr., M. J., Niewiarowski, P. H., Navas, C. A., ... Navas, C. A. 2002. The evolution of thermal physiology in ectotherms. *Journal of Thermal Biology* **27**: 249–268.
- Angilletta, M.J., Dunham, A.E. 2003. The temperature-size rule in ectotherms: simple evolutionary explanation may not be general. *The American Naturalist* **162**: 332-342.
- Ashton, K. G., & Feldman, C. R. 2003. Bergmann's Rule in non-avian reptiles: Turtles follow it, lizards and snakes reverse it. *Evolution* **57**: 1151-1163.
- Aubret, F., & Shine, R. 2010. Thermal plasticity in young snakes: how will climate change affect the thermoregulatory tactics of ectotherms? *The Journal of Experimental Biology* **213**: 242–248.
- Ayers, D. Y., & Shine, R. 1997. Thermal influences on foraging ability: body size, posture and cooling rate of an ambush predator, the python *Morelia spilota*. *Functional Ecology* **11**: 342–347.
- Bandelt, H. J., Forster, P., & Röhl, A. 1999. Median-joining networks for inferring intraspecific phylogenies. *Molecular Biology and Evolution* **16**: 37–48.
- Arévalo, E., Davis, S.K., Sites, J.W. 1994. Mitochondrial DNA sequence divergence and phylogenetic relationships among eight chromosome races of the *Sceloporus grammicus* complex (Phrynosomatidae) in central Mexico. *Systematic Biology* **43**: 387-418.
- Barlow, A., Baker, K., Hendry, C. R., Peppin, L., Phelps, T., Tolley, K. A., Wüster, C.E., Wüster, W. 2013. Phylogeography of the widespread African puff adder (*Bitis arietans*) reveals multiple Pleistocene refugia in southern Africa. *Molecular Ecology* **22**: 1134–1157.
- Bauwens, D., Theodore, G., Castilla, A.M., van Damme, R. 1995. Evolution of sprint speed in lacertid lizards: morphological, physiological and behavioral covariation. *Evolution* **49**: 848-863.
- Bergmann, C. 1847. Über die verhältnisse der warmeökonomie der thiere zu ihrer grosse. *Göttinger Studien* **1**: 595-708.
- Bobe, R., Behrensmeyer, A. K., & Chapman, R. E. 2002. Faunal change, environmental variability and late Pliocene hominin evolution. *Journal of Human Evolution* **42**: 475–497.
- Bogert, C. M. 1949. Thermoregulation in reptiles, a factor in evolution. *Evolution* **3**: 195-211.
- Born, J., Linder, H. P., Desmet, P. 2007. The Greater Cape Floristic Region. *Journal of Biogeography* **34**: 147-162.

- Botts, E.A., Erasmus, B.F.N., Alexander, G.J. 2013. Small range size and narrow niche breadth predict range contractions in South African frogs. *Global Ecology and Biogeography* **22**: 567-576.
- Botts, E.A., Erasmus, B.F.N., Alexander, G.J. 2015. Observed range dynamics of South African amphibians under conditions of global change. *Austral Ecology* **40**: 309-317.
- Bowie, R. C. K., Fjeldså, J., Hackett, S. J., & Crowe, T. M. 2004. Molecular evolution in space and through time: mtDNA phylogeography of the Olive Sunbird (*Nectarinia olivacea/obscura*) throughout continental Africa. *Molecular Phylogenetics and Evolution* **33**: 56–74.
- Branch, W.R. 1998. *Field guide to snakes and other reptiles of southern Africa*. Struik, Cape Town, South Africa.
- Bush, G. L. 1975. Modes of animal speciation. *Annual Review of Ecology and Systematics* **6**: 339–364.
- Chase, B. M., Meadows, M. E. 2007. Late Quaternary dynamics of southern Africa's winter rainfall zone. *Earth Science Reviews* **84**: 103-138.
- Clement, M., Posada, D., Crandall, K.A. 2000. TCS: a computer program to estimate gene genealogies. *Molecular Ecology* **9**: 1657-1659.
- Couper, P.J., Sadlier, R.A., Shea, G.M., Wilmer, J.W. 2008. A reassessment of *Saltuarius swaini* (Lacertilia: Diplodactylidae) in south-eastern Queensland and new South Wales; two new taxa, phylogeny, biogeography and conservation. *Records of the Australia Museum* **60**: 87-118.
- Cowles, R.B. 1945. Surface-mass ratio, paleoclimate and heat sterility. *The American Naturalist* **79**: 561-567.
- Cowling, R.M., Proches, S., Partridge, T.C. 2009. Explaining the uniqueness of the Cape Flora: Incorporating geomorphic evolution as a factor for explaining its diversification. *Molecular Phylogenetics and Evolution* **51**: 67-74.
- Daniels, S. R., Mouton, P. L. F. N., & Du Toit, D. A. 2004. Molecular data suggest that melanistic ectotherms at the south-western tip of Africa are the products of Miocene climatic events: evidence from cordylid lizards. *Journal of Zoology* **263**: 373–383.
- Daniels, S. R., Hofmeyr, M. D., Henen, B. T., & Crandall, K. A. 2007. Living with the genetic signature of Miocene induced change: Evidence from the phylogeographic structure of the endemic angulate tortoise *Chersina angulata*. *Molecular Phylogenetics and Evolution* **45**: 915–926.

- Daniels, S.R., Hofmeyr, M.D., Henen, B.T., Baard, E.H. 2010. Systematics and phylogeography of a threatened tortoise, the speckled padloper. *Animal Conservation* **13**: 237-246.
- Danley, P. D., & Kocher, T. D. 2001. Speciation in rapidly diverging systems: Lessons from Lake Malawi. *Molecular Ecology* **10**: 1075–1086.
- deMenocal, P.B. 1995. Plio-Pleistocene African climate. *Science* **270**: 53-59.
- deMenocal, P. B. 2004. African climate change and faunal evolution during the Pliocene-Pleistocene. *Earth and Planetary Science Letters* **220**: 3–24.
- Desmet, P.G. 1996. *Vegetation and restoration potential of the arid coastal belt between Port Nolloth and Alexander Bay, Namaqualand, South Africa*. M.Sc. thesis. Dept of Botany, University of Cape Town.
- Diamond, J. M. 1986. Evolution of ecological segregation in the New Guinea montane avifauna. *Community ecology* 98-125 Editors: J. M. Diamond & T. J. Case. Harper and Row, Cambridge, Massachusetts, USA.
- Doebeli, M., & Dieckmann, U. 2003. Interim Report: Speciation along environmental gradients. *Nature* **421**: 259–264.
- Driver, A., Desmet, P., Rouget, M., Cowling, R.M., Maze, K. 2003. Succulent Karoo ecosystem plan: biodiversity component. Technical Report Cape Conservation Unit, Botanical Society of South Africa, Kirstenbosch.
- Dupanloup, I., Schneider, S., & Excoffier, L. 2002. A simulated annealing approach to define the genetic structure of populations. *Molecular Ecology* **11**: 2571–81.
- Edwards, S., Vanhooydonck, B., Herrel, A., Measey, G. J., & Tolley, K. A. 2012. Convergent evolution associated with habitat decouples phenotype from phylogeny in a clade of lizards. *PLoS ONE* **7**: e51636.
- Engelbrecht, H.M., Van Niekerk, A., Heideman, N.J.L., Daniels, S.R. 2013. Tracking the impact of Pliocene/Pleistocene sea level and climatic oscillations on the cladogenesis of the Cape legless skink, *Acontias meleagris* species complex, in South Africa. *Journal of Biogeography* **40**: 492-506.
- Engleder, A., Haring, E., Kirchhof, S., Mayer, W. 2012. Multiple nuclear and mitochondrial DNA sequences provide new insights into the phylogeny of South African Lacertids (Lacertidae, Eremiadinae). *Journal of Zoological Systematics and Evolutionary Research* **51**: 132–143.
- Excoffier, L., Laval, G., Schneider, S. 2005. Arlequin (version 3.0): An integrated software package for population genetics data analysis. *Evolutionary Bioinformatics* **1**: 47–50.

- Farris, J. S., Kallersjo, M., Kluge, A. G., & Bult, C. 1994. Testing significance of incongruence. *Cladistics-The International Journal Of The Willi Hennig Society* **10**:315–319.
- Farris, J.S., Kallersjo, M., Kluge, A.G. Bult, C. 1995. Constructing a significance test for incongruence. *Systematic Biology* **44**: 570-572.
- Fitzpatrick, B. M. 2009. Power and sample size for nested analysis of molecular variance. *Molecular Ecology* **18**: 3961–3966.
- Forster, P., Torroni, A., Renfrew, C., & Röhl, A. 2001. Phylogenetic star contraction applied to Asian and Papuan mtDNA evolution. *Molecular Biology and Evolution* **18**: 1864–1881.
- Gavrilets, S. 2004. Fitness landscapes and the origin of species. Editors : Levin, S. A., Horn, H. S. *Princeton University Press*, Princeton and Oxford.
- Gavrilets, S., & Losos, J. B. 2009. Adaptive radiation: contrasting theory with data. *Science* **323**: 732–737.
- Gouws, G., Stuart, B. A., & Daniels, S. R. 2004. Cryptic species within the freshwater isopod *Mesamphisopus capensis* (Phreatoicidea: Amphisopodidae) in the Western Cape, South Africa: allozyme and 12S rRNA sequence data and morphometric evidence. *Biological Journal of the Linnean Society* **81**: 235–253.
- Heideman, N.J.L., Mulcahy, D.G., Sites Jr., J.W., Hendricks, M.G.J., Daniels, S.R. 2011. Cryptic diversity and morphological convergence in threatened species of fossorial skinks in the genus *Scelotes* (Squamata: Scincidae) from the Western Cape Coast of South Africa: Implications for species boundaries, digit reduction and conservation. *Molecular Phylogenetics and Evolution* **61**: 823-833.
- Hipsley, C.A., Himmelmann, L., Metzler, D., Müller, J. 2009. Integrating of bayesian molecular clock methods and fossil-based soft bounds reveals Cenozoic origin of African lacertid lizards. *BMC Evolutionary Biology* **9**: 151.
- Huey, R.B. 1982. Temperature, physiology and the ecology of reptiles. *Biology of the Reptilia* **12**: 25-91.
- Hutchinson, D.W., Templeton, A.R. 1999. Correlation of pairwise genetic and geographic distance measures: inferring the relative influences of gene flow and drift on the distribution of genetic variability. *Evolution* **53**: 1898-1914.
- Kawata, M., Shoji, A., Kawamura, S., & Seehausen, O. 2007. A genetically explicit model of speciation by sensory drive within a continuous population in aquatic environments. *BMC Evolutionary Biology* **7**: 99.

- Kimbel, W.H. 1995. Hominid speciation and Pliocene climate change. In: *Paleoclimate and evolution with emphasis on human origins*. Editors: E.S. Vrba, G.H. Denton, T.C. Partridge and L.H. Burckle. *Yale University Press*, New Haven, CT, pp. 425–437.
- Kingsolver, J. G., & Woods, H. A. 1997. Thermal sensitivity of growth and feeding in *Manduca sexta* caterpillars. *Physiological Zoology* **70**: 631–638.
- Kohlsdorf, T., Garland, T., & Navas, C. A. 2001. Limb and tail lengths in relation to substrate usage in *Tropidurus* lizards. *Journal of Morphology* **248**: 151–164.
- Lamb, T., & Bauer, A. M. 2003. *Meroles* revisited: Complementary systematic inference from additional mitochondrial genes and complete taxon sampling of southern Africa's desert lizards. *Molecular Phylogenetics and Evolution* **29**: 360–364.
- Larkin, M. A., Blackshields, G., Brown, N. P., Chenna, R., Mcgettigan, P. A., McWilliam, H., Valentin, F., Wallace, I.M., Wilm, A., Lopez, R., Thompson, J.D., Gibson, T.J., Higgins, D. G. 2007. Clustal W and Clustal X version 2.0. *Bioinformatics* **23**: 2947–2948.
- Lechmere-Oertel, R. G., Cowling, R. M. 2001. Abiotic determinants of the Fynbos/Succulent Karoo boundary, South Africa. *Journal of Vegetation Science* **12**: 75–80.
- Linder, H.P., Meadows, M.E., Cowling, R.M. 1992. History of the Cape flora. The ecology of fynbos, nutrients, fire and diversity. Editors: R.M. Cowling. *Oxford University Press*, Oxford, pp. 113–134.
- Linder, H.P. 2003. The radiation of the Cape flora, southern Africa. *Biological Reviews of the Cambridge Philosophical Society* **78**: 597–638.
- Linder, H. P., Johnson, S.D., Kuhlmann, M., Matthee, C. A., Nyffeler, R., Swartz, E. R. 2010. Biotic diversity in the southern African winter- rainfall region. *Current Opinion in Environmental Sustainability* **2**: 109–116.
- Losos, J.B. 2009. Lizard in an evolutionary tree. Editor: Greene, H. W. *University of California Press*, Berkeley.
- Lutjeharms, J.R.E. 1998. Coastal hydrography. In: *Field guide to the eastern and southern Cape coasts*. Editors: Lubke, R.A. & De Moor, I. University of Cape Town Press, Cape Town, pp. 50–62.
- Makokha, J. S., Bauer, A. M., Mayer, W., & Matthee, C. A. 2007. Nuclear and mtDNA-based phylogeny of southern African sand lizards, *Pedioplanis* (Sauria: Lacertidae). *Molecular Phylogenetics and Evolution* **44**: 622–633.
- Mayer, W., Pavlicev, M. 2007. The phylogeny of the family Lacertidae (Reptilia) based on nuclear

DNA sequences: Convergent adaptations to arid habitats within the subfamily Eremiinae. *Molecular Phylogenetics and Evolution* **44**: 1155-1163.

Mayr, E. 1963. Animal species and evolution. The Belknap Press of Harvard University Press, Cambridge, Massachusetts.

Matthee, C. A., Flemming, A. F. 2002. Population fragmentation in the southern rock agama, *Agama atra*: More evidence for vicariance in southern Africa. *Molecular Ecology* **11**: 465–471.

Midgley, G.F., Hannah, L., Roberts, R., MacDonald, D.J., Allsopp, J. 2001. Have Pleistocene climatic cycles influenced species richness patterns in the greater Cape Mediterranean Region? *Journal of Mediterranean Ecology* **2**: 137–144.

Midgley, G.F., Roberts, R. 2001. Past climate change and the generation and persistence of species richness in a biodiversity hotspot, the Cape Flora of South Africa. In: *Global Change and Protected Areas*. Editors: Visconti, G., Beniston, M., Iannorelli, E.D., Barba, D. Advances in global change research pp. 393-402. Kluwer Academic Press.

Midgley, G.F., Reeves, G., Klak, C. 2005. Late Tertiary and Quaternary climate change and centres of endemism in the southern African flora. In: *Conservation Biology 8: Phylogeny and Conservation*. Editors: Purvis, A., Gittleman, J.L., Brooks, T. Cambridge University Press, New York.

Miller, M. P. 2005. Alleles In Space (AIS): Computer software for the joint analysis of interindividual spatial and genetic information. *Journal of Heredity* **96**: 722–724.

Mucina, L., Rutherford, M.C., Powrie, L. 2006. Vegetation map of South Africa, Lesotho and Swaziland: *shapefiles of basic mapping units. Beta version 4.0*. South African National Botanical Institute, Cape Town, South Africa.

Palumbi, S. 1996. Nucleic acids II: the polymerase chain reaction. In: *Molecular systematics 2nd edition*. Editors: Hills, D.M., Mortiz, C., Mable, B.K. Sinauer Associates, Sunderland, MA, USA, pp. 205-247.

Partridge, L., Coyne, J.A. 1997. Bergmann's rule in ectotherms: is it adaptive? *Evolution* **51**: 632-635.

Partridge, T.C., Avery, D. M., Botha, G. A., Brink, J. S., Deacon, J., Herbert, R. S., Maud, R. R., Scott, K., Talma, A. S., Vogel, J. C. 1990. Late Pleistocene and Holocene climatic change in southern Africa. *South African Journal of Science* **86**: 302-306.

Partridge, T.C. 1993. Warming phases in southern Africa during the last 150 000 years: an overview. *Palaeogeography, Palaeoclimatology, Palaeoecology* **101**: 237-244.

- Peters, R. H. 1983. The ecological implications of body size. *Cambridge University Press*, Cambridge, U.K.
- Pincheira-Donoso, D., Hodgson, D.J., Tregenza, T. 2008. The evolution of body size under environmental gradients in ectotherms: why should Bergmann's rule apply to lizards? *BMC Evolutionary biology* **8**: 68.
- Polzin, T., Daneshmand, S.V. 2003. On Steiner trees and minimum spanning trees in hypergraphs. *Operations Research Letters* **31**: 12–20.
- Posada, D. 2008. jModelTest: Phylogenetic model averaging. *Molecular Biology and Evolution* **25**: 1253–1256.
- Potts, R. 1996. Evolution and climate variability. *Science* **273**: 922–923.
- Powney, G.D., Grenyer, R., Orme, C.D.L., Owens, P.F. 2010. Hot, dry and different: Australian lizard richness is unlike that of mammals, amphibians and birds. *Global Ecology and Biogeography* **19**: 386-396.
- Price, B.W., Barker, N.P., Villet, M.H. 2007. Patterns and processes underlying evolutionary significant units in the *Platypleura stridula* L. species complex (Hemiptera: Cicadidae) in the Cape Floristic Region, South Africa. *Molecular Ecology* **16**: 2574-2588.
- Rabosky, D.L., Donnellan, S.C., Talaba, A.L., Lovette, I.J. 2007. Exceptional among-lineage variation in diversification rates during the radiation of Australia's most diverse vertebrate clade. *Proceedings of the Royal Society B: Biological Sciences* **274**: 2915-2923.
- Rambaut, A., Drummond, A.J. 2007. Tracer version 1.5. Computer program and documentation distributed by author. Accessed July 2011. Available from <http://beast.bio.ed.ac.uk/Tracer>.
- Ronquist, F., Huelsenbeck, J.P. 2003. MrBayes 3: Bayesian phylogenetic inference under mixed models. *Bioinformatics* **19**: 1572–1574.
- Rousset, F. 1997. Genetic differentiation and estimation of gene flow from F-statistics under isolation by distance. *Genetics* **145**: 1219-1228.
- Schluter, D. 2000. The ecology of adaptive radiation. Oxford University Press. Oxford, New York.
- Schneider, C., Moritz, C. 1999. Rainforest refugia and evolution in Australia's wet tropics. *Proceedings of the Royal Society of London B* **266**: 191–196.
- Schulze, R.E. 2007. South African atlas of climatology and agrohydrology. WRC Report 1489/1/06. Pretoria: Water Research Commission.
- Schumann, E.H. 1998. The coastal ocean off southeast Africa, including Madagascar coastal

- segment. In: *The sea: the global coastal ocean II. Regional studies and syntheses*. 11. Editors: Robinson, A.R., Brink, K.H., pp. 557–581.
- Sears, M.W., Angilletta, M.J. 2004. Body size clines in *Sceloporus* lizards: proximate mechanisms and demographic constraints. *Integrative and Comparative Biology* **44**: 433-442.
- Shine, R., Madsen, T. 1996. Is thermoregulation unimportant for most reptiles? An example using water pythons (*Liasis fuscus*) in tropical Australia. *Physiological Zoology* **69**: 252-269.
- Shoo, L. P., Rose, R., Doughty, P., Austin, J. J., Melville, J. 2008. Diversification patterns of pebble-mimic dragons are consistent with historical disruption of important habitat corridors in arid Australia. *Molecular Phylogenetic and Evolution* **48**: 528-542.
- Siesser, W.G. 1978. Aridification of the Namib Desert, evidence from oceanic cores. In: *Antarctic Glacial History and World Palaeoenvironments*. Editor: E.M. van Zinderen Bakker. Balkema, Rotterdam.
- Siesser, W.G. 1980. Late Miocene origin of the Benguela upwelling system off northern Namibia. *Science* **208**: 283-285.
- Slatkin, M. 1987. Gene flow and the geographic structure of natural populations. *Science* **236**: 787-792.
- Slatkin, M. 1993. Isolation by distance in equilibrium and non-equilibrium populations. *Evolution* **47**: 264-279.
- Smith, J.M. 1989. *Evolutionary genetics*. Oxford University Press, New York, New York.
- Smith, T. B., Schneider, C. J., & Holder, K. 2001. Refugial isolation versus ecological gradients. Testing alternative mechanisms of evolutionary divergence in four rainforest vertebrates. *Genetica* **112**: 383–398.
- Stamatakis, A. 2006. RAxML-VI-HPC: Maximum likelihood-based phylogenetic analyses with thousands of taxa and mixed models. *Bioinformatics* **22**: 2688–2690.
- Stevenson, R.D. 1985. Body size and limits to the daily range of body temperature in terrestrial ectotherms. *The American Naturalist* **125**: 102-117.
- Stowe, M., Sealy, J. 2015. Terminal Pleistocene and Holocene dynamics of southern Africa 's winter rainfall zone based on carbon and oxygen isotope analysis of bovid tooth enamel from Elands Bay Cave. *Quaternary International XXX*, 1-11.
- Streelman, J. T., Danley, P. D. 2003. The stages of vertebrate evolutionary radiation. *Trends in Ecology and Evolution* **18**: 126–131.

- Swart, B. L., Tolley, K. A., Matthee, C. A. 2009. Climate change drives speciation in the southern rock agama (*Agama atra*) in the Cape Floristic Region, South Africa. *Journal of Biogeography* **36**: 78–87.
- Swofford, D. L. 2002. PAUP*: phylogenetic analysis using parsimony (*and other methods). Version 4.0b10. *Sinauer Associates*, Sunderland, MA.
- Tamura, K., Peterson, D., Peterson, N., Stecher, G., Nei, M., & Kumar, S. 2011. MEGA5: Molecular evolutionary genetics analysis using maximum likelihood, evolutionary distance, and maximum parsimony methods. *Molecular Biology and Evolution* **28**: 2731–2739.
- Tankard, A.J., Rogers, J. 1978. Late Cenozoic palaeoenvironments on the West Coast of southern Africa. *Journal of Biogeography* **5**: 319–337.
- Tolley, K.A., Burger, M., Turner, A.A., & Matthee, C.A. 2006. Biogeographic patterns and phylogeography of dwarf chameleons (*Bradypodion*) in an African biodiversity hotspot. *Molecular Ecology* **15**: 781–793.
- Tolley, K.A., Chase, B.M., & Forest, F. 2008. Speciation and radiations track climate transitions since the Miocene Climatic Optimum: A case study of southern African chameleons. *Journal of Biogeography* **35**: 1402–1414.
- Tolley, K.A., Sakwa, J., Houniet, D.T., Swart, B.L., & Matthee, C.A. 2009. The potential for predicted climate shifts to impact genetic landscapes of lizards in the South African Cape Floristic Region. *Molecular Phylogenetics and Evolution* **51**: 120–130.
- Tolley, K.A., Bowie, R.C.K, Measey, G.J., Price, B.W., Forest, F. 2014. The shifting landscape of genes since the Pliocene: terrestrial phylogeography in the Greater Cape Floristic Region. *In*: Fynbos: Ecology, Evolution and Conservation of a Megadiverse Region. Editors: Allsopp, N., Colville, J.F., Verboom, G.A., pp. 142–163.
- Tyson, P.D., Preston-Whyte, R.A. 2000. The atmosphere, weather and climate of southern Africa. Cape Town: Oxford University Press.
- Vanhooydonck, B., Measey, J., Edwards, S., Makhubo, B., Tolley, K.A., & Herrel, A. 2015. The effects of substratum on locomotor performance in lacertid lizards. *Biological Journal of the Linnean Society* **115**: 869–881.
- Visser, M.E. 2008. Keeping up with a warming world: assessing the rate of adaptation to climate change. *Proceedings of the Royal Society B: Biological Sciences* **275**: 649–659.
- Walters, R.J., Hassall, M. 2006. The temperature-size rule in ectotherms: may a general explanation exist after all? *The American Naturalist* **167**: 510–523.

Williams, E.E. 1972. The origin of faunas. Evolution of lizard congeners in a complex island fauna: a trial analysis. *Evolutionary Biology* **6**: 47-89.

CHAPTER 3

Thermal traits of two sites identify potential mechanistic traits for species distribution modelling of *Meroles knoxii*'s southern distribution range

3.1 INTRODUCTION

Thermal sensitivity refers to the degree to which an organism's physiology depends on temperature (Angilletta, 2009), because temperature influences the rates of chemical and biochemical reactions (Hochachka & Somero, 2002). These influences lead to functional thermal sensitivities at the cellular, systemic and organismal levels (Rome *et al.*, 1992) and places limitations on the occurrence and persistence of life. Ectotherms obtain most of their body heat from their environments through convection, conduction and radiation (Cowles, 1965). Energy exchanged from the environment, through these various avenues, affects the ectotherm's body temperature (T_b). These effects on T_b , in turn, affect the performance of individuals (Angilletta, 2002). Physiological and behavioural traits are sensitive to body temperature such as movement (Bauwens *et al.*, 1995), foraging ability (Ayers & Shine, 1997), growth and feeding rates (Autumn & De Nardo, 1995; Kingsolver & Woods, 1997; Aubret & Shine, 2010) and locomotion (Herrel *et al.*, 2007).

Behavioural thermoregulation is one of the primary mechanisms used by ectotherms to maintain body temperature within an optimal range (Angilletta, 2002). However, not all ectotherms thermoregulate to the same extent. Certain species are predominantly thermoconformers (Hertz *et al.*, 1993; Rummery *et al.*, 1994), whereas others thermoregulate precisely (Bauwens *et al.* 1995; Sartorius *et al.*, 2002). In addition, variation exists among thermoregulators, where certain species appear to maintain the constancy of T_b over time with great precision and others to a lesser extent (Hertz *et al.*, 1993). The cost-benefit model of thermoregulation (Huey & Slatkin, 1976) aims to describe this variation and suggests that ectotherms become thermoconformers when the costs of thermoregulation are greater than the potential benefits.

Heliothermic lizards rely greatly on solar radiation to regulate their body temperatures. Studies suggest that lizards thermoregulate behaviourally by shuttling between sun and shade microsites to maintain their body temperatures within a relatively narrow range (Cowles & Bogert, 1944; Bogert, 1959; Templeton, 1970; Castilla *et al.*, 1999). In addition, they alter their heat flux by modifying body postures to adjust the surface area exposed to energy sources of heat and cold (Heath, 1965; Bartholomew, 1966; Barlett & Gates, 1967; DeWitt, 1971; McConnachie *et al.*, 2009) and by adjusting activity times (Porter *et al.*, 1973; Huey, 1974). The thermal ranges obtained through these behaviours are thought to optimize fitness (Blouin-Demers & Nadeau, 2005). Whilst thermoregulation is considered a complex phenomenon, it can be seen as a continuum of strategies: from thermal specialists who actively maintain a narrow range of body temperatures to thermal generalists or thermoconformers who passively experience the variation in ambient thermal conditions (Angilletta, 2002). Yet, if thermal specialists are unable to behaviourally maintain their body temperatures within this optimal range, how would they survive?

Temperate species typically display bimodal activity patterns during hot summer seasons (activity peaking late morning and late afternoon) and unimodal activity during autumn and winter seasons (Cloudsley-Thompson, 1991; Foa & Bertolucci, 2001). These shifts in activity patterns are considered to depend on thermal constraints and which activity strategy is more energetically advantageous. As operative temperatures increase and surpass preferred or tolerable body temperatures, lizards will experience activity constraints such as having to spend longer periods in refuges, decreasing net energy gain, which could affect survival and reproduction (Huey *et al.*, 2010). The thermal optimum and breadth of performance are characteristics directly related to a lizards' activity patterns and are considered ecologically relevant (Hertz *et al.*, 1983; van Berkum, 1988). Activity restriction due to climate change has already been noted in several lizard populations and hypothesized to cause local population extinctions (Sinervo *et al.*, 2010).

Climate change is considered a threat to reptile fauna (Chapter 1), with abiotic environmental variables used to identify which species are more likely to be affected by the threat of climate change. Reptiles are likely to respond by physiological adaptation, dispersal to more favourable habitats or passively becoming isolated in refugial areas and possibly going extinct (Visser, 2008; Grigg & Buckley, 2013). Typically rapid evolutionary changes are less likely to occur in reptiles due to relatively longer lifespan when compared to, for example, insects. However, phenotypic plasticity has been earmarked as a potential response to climate change, as these short term or long term changes in behaviour and physiology could maximize fitness (Angilletta, 2009; but see Clusella-Trullas & Chown 2014; Gunderson & Stillman, 2015).

Biomechanical and physiological theory suggests that certain design characteristics required to maximize the performance of different traits could be challenging to reconcile in a single phenotype (Vanhooydonck *et al.*, 2001) and so theoretical models are based on the "jack of all trades is a master of none" (Huey & Slatkin, 1976; Pianka, 1978; Huey & Hertz, 1984) possibly resulting in trade-offs between the performance breadth and the maximal level of performance specialization (Angilletta *et al.*, 2003). For instance, lacertid lizards display different foraging behaviours with some species being relatively sedentary, sit-and-wait (ambush) foragers and other species being active, wide foraging predators (Huey *et al.*, 1984; Bauwens *et al.*, 1995). Research suggests that these differences in foraging behaviour could be related to locomotor capacity, with ambush foragers lacking the stamina of wide-foraging lizards and wide-foraging lizards lacking the sprint speed required for ambush predation (Vanhooydonck *et al.*, 2014).

The relationship between climate and thermal physiology requires the identification of a species thermal performance breadths and maximum performance as it depends on an individual's optimum temperature (Angilletta *et al.*, 2009). Performance is evaluated using thermal reaction norms, or precisely fitted thermal performance curves. It is a measure of an organism's capacity to function (Angilletta, 2002). The critical thermal minimum (CT_{min}) and critical thermal maximum

(CT_{max}) are the lower and upper thermal limits of this performance, respectively, and thus provide the limits at which ecologically relevant functions cease. Critical thermal limits (CTLs) are reversible and non-fatal. However, given that ecologically relevant functions cease, i.e. predator evasion and foraging ability, these temperatures severely impact the survival ability of an individual.

Unfortunately the baseline data of preferred temperatures and performance breadths are lacking for most southern African reptiles. Given the increases in temperature and variable precipitation predicted under several climate change models for South Africa (Chapter 1), the potential activity periods available to lizards could be influenced drastically, therefore the thermal sensitivity of these ectotherms need to be known.

As the ability of lacertid lizards to respond to the rapid environmental changes through evolutionary means might be limited (Bauwens *et al.*, 1995), the yoke could lie upon their physiological capability to compensate, either through behavioural thermoregulation or thermal variability (Aubret & Shine, 2010). Given that research suggests the biotic impacts of climate change could be mediated by physiology (Huey *et al.*, 2010; Dillon *et al.*, 2010), identifying conserved and variable traits could serve to elucidate future climate change responses for species and populations. For instance, evaporative water loss (EWL) is considered a variable trait, where EWL of different reptile species are highly correlated with the aridity of their habitats (Shoemaer & Nagy, 1977; Mautz, 1982; Nagy, 1982). In fact, EWL has been shown to differ intraspecifically, with lizard populations in humid areas displaying higher water loss rates relative to their congeners inhabiting drier habitats (Cloudsley-Thompson, 1991). Likewise, metabolic rate has been shown to differ significantly between two populations of *Sceloporus undulatus* lizards (Angilletta, 2001); however, these differences were season specific. Furthermore, apparent variability of preferred body temperatures suggests a greater adaptive capacity of lizards to climate change (Van Damme *et al.*, 1986; Gvozdik, 2012). In contrast, thermal tolerance breadths and CT_{max} in particular, have been suggested to be more constrained than CT_{min} in several lizard species (Bauwens *et al.*, 1995; Grigg & Buckley, 2013).

Therefore, various temperature dependent traits should be measured to establish these baseline data and identify which traits are variable and which are not. These data could then be used on large or small spatial scales and account for the extent of variability within traits. Incorporating these traits as mechanistic variables in species distribution modelling (SDM) could then progress the accuracy of predicting species future responses to climate change and ultimately improve estimates of extinction risk (Kearney *et al.*, 2009). SDM's use spatial environmental data to infer species range limits and habitat suitability. In effect, these models endeavour to determine the components encompassing a species ecological niche. Most SDM's are correlative and link these spatial data with species distribution records (Kearney *et al.*, 2004). Recently, SDM's have

endeavoured a novel approach by incorporating mechanistic variables or functional traits and linking these traits with environmental variables in an effort to improve estimates of species responses to climate change (Kearney & Porter, 2004; Kearney *et al.*, 2009; Duckett *et al.*, 2013). For instance, physiological responses and constraints of lizard species can be associated to those species' distribution ranges, identifying the fundamental niche, which could in turn be mapped to infer range constraints. As such, traits and their variation (e.g. degree of variability, inter-population variation) should be considered when applying SDM's as populations and even individuals are unlikely to respond in similar ways. The absence of such consideration could lead to erroneous species response estimates.

The distribution ranges of species are considered a fundamental unit of macroecology (Brown *et al.*, 1996; Gaston, 2003; Whitton *et al.*, 2012; Bonino *et al.*, 2015). Distribution can likely vary due to numerous factors including (but not limited to): climate, competition and resource availability (Bonino *et al.*, 2015). Ectotherm distributions are presumably sensitive to climate and its variation. For the genetic mechanistic variables of SDM's, Chapter 2 identified three clades for *M. knoxii*, which should be used, in conjunction with environmental variables, to model each separate evolutionary significant unit/clade's potential response to climate change. In addition, the southern clade could be considered one genetic population as several sites (n=9) within the southern clade showed no significant genetic population structure (Chapter 2). The southern clade appears to consist of mesic adapted individuals with smaller body sizes. Given that smaller body sizes are associated with relatively higher rates of heating and cooling (Ashton & Feldman, 2003) this population might be at greater risk of climate change relative to the other clades identified. However, variability of thermal traits might occur at small spatial scales. Therefore, identifying whether and which thermal traits are more likely to differ at small spatial scales within the southern clade, is paramount to determining whether this population's thermal traits can be modelled as a single unit or whether thermal trait variability should be taken into account.

To determine whether certain thermal traits of *M. knoxii* differ at a small spatial scale within the southern clade, several thermal traits of individuals at two sites were investigated. The sites, Zandvlei Nature Reserve (ZNR) and Rietvlei Nature Reserve (RNR), are situated in close proximity (30km; Fig. 3.1) with no noticeable climatic differences. If presumably conserved thermal traits differ at this small spatial scale, inter-population variation could be advantageous for *M. knoxii* as certain sites within this genetic population might be able to tolerate impending future climate changes. However, if these thermal traits are conserved between sites, the absence of variability could impose additional constraints in face of climatic changes. Fortunately, conservative traits could serve to extrapolate SDM findings to other sites within the southern clade and hopefully improve estimates of *M. knoxii*'s potential responses to future climate change.

Firstly, as ectotherms are dependent on their environmental temperatures, thermal traits measured for *M. knoxii* should reflect this thermal sensitivity, i.e. total evaporative water loss and resting metabolic rate should increase with an increase in temperature. *Merops knoxii* is a temperate-adapted lacertid lizard. Such species typically display a broad thermal tolerance breadth (Bonino *et al.*, 2015) and thermal tolerance breadths are considered conserved for Lacertoidea (Grigg & Buckley, 2013). I hypothesize both sites of *M. knoxii* would display similar, wide thermal tolerance breadths. In addition, critical thermal maxima (CT_{max}) should be highly conserved between these sites as critical thermal limits are typically conserved throughout evolutionary history (Grigg & Buckley, 2013), with both sites displaying CT_{max} characteristic of lacertid lizards (Bauwens *et al.*, 1995). Likewise, preferred body temperatures (T_{sel}) are expected to not differ between sites as T_{sel} is thought to be conserved within clades for certain lizards (Grigg & Buckley, 2013) and both sites occur within the southern clade. Also, range of T_{sel} should correspond to the optimal performance temperatures as these temperatures are thought to correspond to temperatures that maximize their physiological needs.

Furthermore, both resting metabolic rate and total evaporative water loss should differ significantly between sites, as these traits have been identified as variable thermal traits for lizards intraspecifically (Angilletta, 2001). As an ambush predator (Cooper & Whiting, 1999), there is likely to be a trade-off between stamina and sprint speed in *M. knoxii* (Vanhooydonck *et al.*, 2014). Ambush foragers also generally display higher sprint speeds at high temperatures than active foragers. Conversely, if a trade-off is found, stamina should be optimal at test temperatures lower than maximal sprint speed temperatures with an early onset of exhaustion at high temperatures.

To test these hypotheses, T_{sel} and CTLs of *M. knoxii* were determined in the laboratory for the two sites mentioned to assess the thermal preferences and thermal tolerance breadths. Furthermore, the sprint speed and stamina were determined at several temperatures to assess whether trade-offs occur in this temperate ambush predator at ZNR. Metabolic rate and total evaporative water loss was estimated at three temperatures to establish the fundamental energetic physiological cost and desiccation resistance at differing temperatures, respectively. Where possible, thermal traits were compared to determine whether and which traits displayed variability or are conserved between these two sites.

3.2 METHODS

Fieldwork, lizard maintenance and laboratory set-up

3.2.1 Selected body temperature (T_{sel})

Lizards were captured from two sites; Zandvlei Nature Reserve (ZNR; n=15) and Rietvlei Nature Reserve (RNR; n=20) in the Western Cape Province during December 2013/January 2014 (Fig.

3.1). Climates do not differ considerably as the sites are only approximately 30km apart, however microclimate could be considerably different as vegetation densities differ at these sites (Edwards 2012).

Animals were captured using a collapsible graphite fishing pole with a nylon noose. Upon capture, each individual's body temperature (T_b) was recorded by probing the cloaca of each lizard using a K-type thermocouple connected to a quick reading electronic thermometer ($^{\circ}\text{C}$; Digital Thermometer Nicety DT804A; Shenzhen AOEOM Technology Co., Shenzhen, Guangdong, China). Each individual's snout vent length (SVL) and tail length (TL) was measured using digital calipers (millimetre (mm); Absolute MyCal E-Z Mitutoyo). Mass (g) was measured using a digital balance.

Immediately after collection, lizards were transported to the South African National Biodiversity Institute (SANBI) at the Kirstenbosch Research Centre. Lizards were kept in terraria (415x170x290mm) with a sand substrate, vegetation and an elevated tile (for shelter) to mimic the natural environment. The sand substrate was obtained from the site and sifted to remove large particles and small invertebrates. Animals were grouped according to sex with no more than five individuals per terrarium. Terraria were placed inside climate controlled rooms where temperatures were set at 28:20 $^{\circ}\text{C}$ cycles (12h:12h). Temperature loggers (iButtons; Maxim Thermochron ibutton, model DS1921G, SD $\pm 1^{\circ}\text{C}$) were placed inside the climate rooms to monitor temperatures. Lizards were provided with mealworms (*Tenebrio molitor* larvae) and grey crickets (*Acheta domesticus*) daily as well as water *ad libitum*. Terraria were sprayed daily with water before animals were fed. Animals were acclimated for seven days at 28:20 $^{\circ}\text{C}$ cycles (12h:12h). These temperatures are used to standardize tests between populations and individuals.

To measure T_{sel} , a stage consisting of pressed wood (1.26x0.73x0.38m) was constructed, divided into six separate parallel lanes along its length. Five infrared lights (Eurolux G230 M-infrared 275W) were suspended at one end and room temperature set to 15 $^{\circ}\text{C}$ to create a temperature gradient ranging from 20 $^{\circ}\text{C}$ at the unlit end and 60 $^{\circ}\text{C}$ where the lights were suspended (following Bauwens *et al.*, 1995). Each lane's floor was covered with sand approximately 1cm deep. Each day, five lizards were placed in separate lanes at 08:00 and allowed to move freely within their respective lanes. After one hour of habituation, T_b was measured by inserting the tip of a K-type thermocouple into the cloacae. T_b measurements were performed hourly, from 09:00 to 17:00. Measurements where lizard handling time exceeded 10 seconds were discarded for analyses. Animals were fasted 24 hours before T_{sel} trials as feeding affects the temperature preference of lizards (Li *et al.*, 2010). The procedure was repeated until all lizards (n=35) had been trialled.

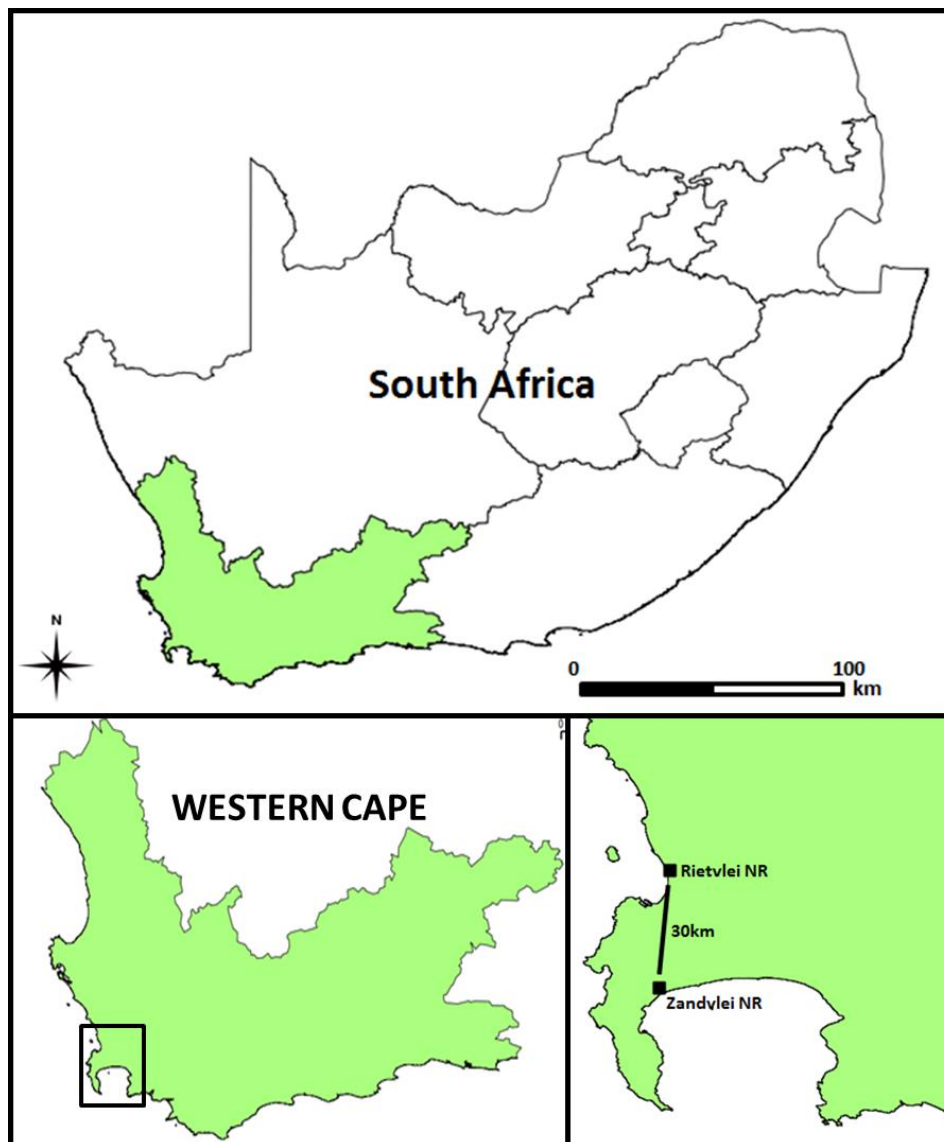

Figure 3.1: Sampled sites at Rietvlei Nature Reserve and Zandvlei Nature Reserve from the south-western region of Western Cape Province of South Africa.

3.2.2 Critical thermal limits (CTL's)

Critical thermal maximum (CT_{max}) and minimum (CT_{min}) were measured for individuals from both sites (RNR: CT_{max} : $n=17$, CT_{min} : $n=15$; ZNR: CT_{max} $n=8$, CT_{min} : $n=8$). After acclimation, individual lizards were placed in a metal container submerged in a waterbath containing either glycol: water (50:50) for CT_{min} trials or water for CT_{max} trials. The container was held down by weights with approximately 5cm of the upper half not submerged. Inside the container, two buttons and two K-type thermocouples were placed on the highest and lowest part of container (Appendix 1.2). Thermocouples were connected to a logger (TC-08 Thermocouple Pico Data Logger) to record temperatures at each second interval. The container was insulated from the ambient environment with a Perspex lid. Pilot trials were performed to ensure a $1^{\circ}\text{C}/\text{min}$ rate of change (Lutterschmidt & Hutchison, 1997) within the container before initial trials introducing the lizards occurred.

Grant *Labwise*TM software was used to program the waterbath (Grant LTC series waterbath; 21L) to run as follows: five minutes at 25°C allowing the animal to habituate and then, temperature decreases at a rate of 1°C per minute to reach -8°C. An individual was placed in the container and monitored visually, prior to the habituation period and during the experiment. Movements and behaviour were noted during trials. When individuals showed signs of reaching the CT_{min} ; i.e. by moving sluggishly or ceasing movement, the Perspex lid was lifted and righting response checked. The ambient temperature registered by the closest thermocouple to the lizard was noted upon loss of righting response as the CT_{min} .

CT_{max} trials were conducted using a Huber CC410 waterbath (22L). Internal software was programmed to run as described for the CT_{min} for the habituation period and then temperature increases at a rate of 1°C per minute to reach 60°C. As with CT_{min} , lizards were monitored the entire trial, and when individuals showed signs of reaching the CT_{max} ; i.e. onset of muscle spasms (Lutterschmidt & Hutchison, 1997), the individual was removed. The temperature registered by the lower thermocouple was noted as the CT_{max} .

Upon completion of the trial, lizards were probed to determine body temperature and then placed in a recovery container, set within a larger container filled with mildly warm or cool water for CT_{min} and CT_{max} trials, respectively. Lizard condition and responsiveness was checked and added to records of condition monitoring. Individuals were weighed before and after each trial with a Mettler Toledo (model AX204, ± 0.07 mg) balance. Animals were fasted 24 hours prior to trials. Where possible, lizards were probed with a K-type thermocouple connected to a quick reading electronic thermometer (Digital Thermometer Nicety DT804A; Shenzhen AOEOM Technology Co., Shenzhen, Guangdong, China) to estimate T_b of CTL's. The lizards acquired for the resting metabolic rate and total evaporative water loss trials were used to determine critical thermal limits of *M. knoxii*. All lizards recuperated from CTL trials unharmed.

3.2.3 Performance traits

Lizards included in performance traits were captured from ZNR during December 2012 (n=14). Methods for acquiring field operative temperatures, measurements of body mass and body size, equipment used and lizard laboratory maintenance are consistent throughout all fieldwork performed (See selected body temperatures).

Sprint speed was measured at five different temperatures; 20°C, 25°C, 30°C, 35°C and 40°C using a 2.5m cork substrate racetrack. The order of test temperatures were randomised as follows: 20°C, 40°C, 35°C, 30°C and 25°C. After the climate chamber reached the desired temperature, lizards were removed from their terraria, placed in cloth bags and moved to the climate chamber, where sprint speed trials were to be conducted, for one hour to acclimate. Lizards were probed with a

thermocouple to ensure body temperature was within range of the desired test temperature just before the trial.

The racetrack consisted of eight pairs of photocells, placed at 25cm intervals on each side of the track (Appendix 1.3), which register when a lizard passes and the time elapsed between passing two subsequent cells were automatically recorded. Each individual was encouraged to race down the track by lightly tapping near or on the tail. Sprint speed was calculated over each interval. Each animal was trialled three times with a resting period of one hour between trials. Upon completion, lizards were placed back in their terraria, sprayed with water and left to rest, feeding them about an hour later.

Stamina was calculated at the five experimental temperatures in the same order as sprint speed. Stamina was quantified on a pressed wood substrate circular track with one lap equivalent to 2.4m, and marked in 12 intervals of 20cm each (Appendix 1.3). Acclimation followed the same procedure as sprint speed. Lizards were encouraged to run around the track from a set starting point, recording both the duration and distance travelled until the animal refused to run further. The trial ended when the lizard showed a loss of righting response after being turned on its back (Huey *et al.* 1990). Each individual was tested twice within one day, with a minimum of one hour resting between trials. Upon completion of all trials, lizards were returned to terraria, sprayed with water and left to rest, feeding them about an hour later. Individuals that did not run continuously were excluded from analysis. As an estimate of maximal stamina, the longest running time of the two trials were used.

3.2.4 Resting metabolic rate (RMR) and total evaporative water loss (TEWL)

Lizards were captured from both study sites (ZNR: n=15; RNR; n=20) during December-February 2014 (see critical thermal limits). RMR and TEWL were measured simultaneously using a flow-through respirometry method. Atmospheric air was pumped through three different scrubbers (Soda Lime, Ascarite and Silica crystals) to remove CO₂ and H₂O before entering a glass cuvette (200ml) where the lizard was housed (Appendix 1.4). Flow rate was set at 40% (200ml/min) and controlled with a Sierra mass flow controller. A Licor gas analyser (LI 7000 CO₂/H₂O Analyser) was used to measure CO₂ production from airflow through the cuvette by measuring the differential CO₂ between incurrent and excurrent air. Baseline was determined for five minutes before and after each trial, to be able to correct for analyser drift if any. The cuvette was placed inside an activity detector (AD2, Sable systems) placed inside an incubator (Labcon FSIM 70; SD ± 0.2°C @ 37°C). The activity detector was connected to a universal interface (UI2, Sable systems) and visualised using Expedata (v1.7.25) to ensure that respiration readings were obtained, at least in part, during a resting phase. The incubator would be set to the desired test temperature before the lizard was placed inside. Two ibuttons (Maxim Thermochron ibutton, model DS1921G, SD ±1°C) were placed inside the activity detector to monitor temperatures experienced inside the incubator. A K-type

thermocouple was fixed to the cuvette and connected to a quick reading electronic thermometer (Digital Thermometer Nicety DT804A; Shenzhen AOEOM Technology Co., Shenzhen, Guangdong, China) to monitor test temperature in real-time. Respiration rate was measured for a minimum of 2.5 hours per test temperature for each individual. Test temperatures were 15°C, 25°C and 35°C, chosen at random. If individuals were not co-operative, i.e. moving around in cuvette, the experiment length would be increased until a minimum of 20 minutes of resting phase was achieved or they would be removed and rerun on another day, depending on time available until photophase ended. Lizards were measured during photophase, from 6am until 6pm. All individuals were weighed (Mettler Toledo balance, model AX204, ± 0.07 mg) before and after each trial. Lizards were probed directly upon removal from the cuvette to determine T_b . Animals were fasted 48 hours before experimental procedure.

3.3 STATISTICAL ANALYSES

All analyses of thermal data were conducted using SPSS (v 20.0). Data were tested for normality using Shapiro-Wilks normality tests and investigated for outliers, skewness and kurtosis to establish whether parametric or non-parametric tests should be used for the respective analyses.

3.3.1 Selected body temperature (T_{sel})

All individuals were included in the analyses, as none lost more than 20% of their initial body mass during acclimation and trial period (Bauwens *et al.*, 1995). As extreme T_{sel} values are considered exploratory behaviour for lizards (Hertz *et al.*, 1993), the central 50% of T_{sel} data were used to calculate the mean, minimum (25th quartile) and maximum (75th quartile) as well as the range of T_{sel} for RNR and ZNR sites separately. Data were generally not normally distributed and therefore, generalized linear models (GZLM) were used to determine whether mean, minimum, maximum and range of T_{sel} differed between RNR and ZNR whereby mean, minimum, maximum and range of T_{sel} were treated as dependent variables and site, mass and site*mass as categorical variables.

3.3.2 Critical thermal limits (CTL's)

CT_{min} and CT_{max} were analysed separately for both sites. As most climate change modelling requires the use of mean annual temperature or air temperature, ambient temperature experienced by the lower ibutton at the critical thermal limit was used as a proxy for core body temperature. Data consisted of the ambient temperature experienced at the critical thermal limit (CTL) and the mass before and after the experiment. Data were not normally distributed (CT_{max} , $\log CT_{min}$ and $\log CT_{max}$), even after \log_{10} transformation, and several outliers were found. Therefore, generalized linear models (GZLM) (with normal family and identity link function) were used to examine all data for the effects of body mass, sex and site (main effects) as well as the interaction of site and body mass on critical thermal limits of *M. knoxii*. CT_{min} and CT_{max} were treated as dependent variables and body mass, sex and site were treated as categorical variables with mass as a covariate.

3.3.3 Performance

The relative performance values for sprint speed and stamina were plotted against body temperature using TableCurve 2D® automated curve fitting analysis (v5.01). Critical thermal minimum and maximum means (see CTL's) were considered the lower and upper thermal limits of performance, where movement ceases. Individual CTL's were not used as test subjects differed between performance and CTL trials. Sprint speed and stamina (distance and time) were fit to "curve peak functions" using asymmetric equations for each individual separately. Curve fits were chosen based on goodness of fit (AIC) and evaluated to determine maximal performance (U_{\max}) and optimal temperature (T_{opt}) at maximal performance. Mean, minimum, maximum and range of U_{\max} and T_{opt} were calculated. After identifying the maximal performance at optimal temperatures, temperature performance breadths at 80% and 95% were calculated for each performance trait. Temperature performance breadths reflect temperature ranges at which animals are able to achieve 80% (T_{pb80}) and 95% (T_{pb95}) of their maximal performance. The T_{pb80} is identified as the temperature range beyond which an animal can no longer fulfil vital survival activities, i.e. predator evasion, foraging, and T_{pb95} is considered the ideal temperature range for vital activities.

A GZLM was used with mass as a predictor of stamina which includes maximal distance travelled until exhaustion and time travelled until exhaustion as dependent variables. As all individuals used for stamina trials were female ($n=5$) from the same site (ZNR), sex was not included as predictor for stamina analyses. For sprint speed; mass, sex ($M=6$, $F=7$) and the interaction of mass*sex were used as predictors of maximal sprint speed performance.

3.3.4 Resting metabolic rate (RMR) and total evaporative water loss (TEWL)

Data from the Licor CO_2 and H_2O analyzer were converted from micromol/mol ($\mu\text{m}/\text{m}$) to volumes of VCO_2 (ml h^{-1}) and from mmol/mol to VH_2O (mg h^{-1}), for RMR and TEWL, respectively, using Expedata (v1.7.25). Resting periods were identified as stable periods of measurement that overlapped with no activity from the activity detector. Extracted data ranged from 20-40 minutes and were extracted from the same resting interval for both VCO_2 and VH_2O . Data were excluded if urination or defecation occurred during experimental trials (Spotila & Berman, 1976). The mean values of the resting phase were used to calculate RMR and TEWL for each individual at the specific test temperature (15°C , 25°C and 35°C). Measurements of VCO_2 and VH_2O production were performed on the same individuals across three different test temperatures (repeated measures). Data were within the prediction of scaling relationships for small lacertid lizards (RMR calculator: $0.288 \text{ ml O}_2 \text{ h}^{-1} @ 20^\circ\text{C}$, mean mass=2.9g; Withers, 1992; TEWL: Duvdevani & Borut, 1974).

VCO_2 and VH_2O production means of the two sites (ZNR and RNR) were first analysed separately. Data of both measurements were not normal; therefore GZLM's were used to investigate RMR and

TEWL. Mean, minimum and maximum VCO_2 and VH_2O were allocated as dependent variables and temperature, site, group, mass and the interactions thereof (site*mass, site*sex and sex*mass) as fixed effects.

3.4 RESULTS

3.4.1 Selected body temperature (T_{sel})

Mean, minimum, maximum and range of central 50% values were used for analyses (Table 3.1). Mean and maximum T_{sel} differed significantly between sites (Table 3.2), whereas minimum and range of T_{sel} did not. Furthermore, mass significantly influenced minimum, maximum and T_{sel} range, but not mean T_{sel} . The interaction of site and mass significantly influenced minimum and maximum T_{sel} , but not mean T_{sel} or T_{sel} range. As sites differed significantly for some dependent variables (mean & max T_{sel}), but not others (min & range T_{sel}) a *post hoc* analysis of covariance (ANCOVA) was used to further investigate differences between sites. ANCOVA results show no significant difference of mean, minimum, maximum and range of T_{sel} between sites (Table 3.2). However, mass influenced mean T_{sel} significantly and the interaction of site*mass significantly influenced minimum T_{sel} , as was also shown by the GZLM (Table 3.2).

Table 3.1: Summary of the central 50% for T_{sel} of ZNR and RNR lizards. All values (minimum, maximum, range and mean) are in °C \pm s.e.m.

Site	N	Mean	Minimum	Maximum	Range
Zandvlei	15	33.5 \pm 0.55	32.3 \pm 0.06	34.6 \pm 0.03	3.3 \pm 0.08
Rietvlei	20	33.1 \pm 0.03	32.3 \pm 0.02	33.9 \pm 0.02	2.2 \pm 0.04

Table 3.2: Generalized linear model for the effects of site, mass and interaction of site*mass on mean, minimum, maximum and T_{sel} range of *M. knoxii* individuals from RNR and ZNR sites combined (left). ANCOVA with body mass as covariate and with site, mass and mass*site as factors (right) Significance is indicated with *.

Generalized linear model				ANCOVA			
Coefficient	x^2 estimate	df	p-value	x^2 estimate	df	F	p-value
<u>Mean T_{sel}</u>							
Intercept	1608137.86	1	<0.01*	3656.222	1	27094.887	<0.01*
Site	12.45	1	<0.01*	0.369	1	2.731	0.1
Mass	78.07	66	0.15	0.872	1	6.46	<0.01*
Site*Mass	7.28	3	0.06	0.082	1	0.606	0.437
<u>Maximum T_{sel}</u>							
Intercept	6021024.12	1	<0.01*	2546.753	1	69321.069	<0.01*
Site	74.36	1	<0.01*	0.697	1	18.971	<0.01*
Mass	126.14	59	<0.01*	0.081	1	2.215	0.139
Site*Mass	8.49	3	<0.05*	0.141	1	3.834	0.052
<u>Minimum T_{sel}</u>							
Intercept	3208659.99	1	<0.01*	2237.639	1	34301.624	<0.01*
Site	0	1	1	0.235	1	3.598	0.06
Mass	150.08	58	<0.01*	0.105	1	1.614	0.206
Site*Mass	17.04	3	<0.01*	0.27	1	4.135	<0.05*
<u>Range T_{sel}</u>							
Intercept	770170.35	1	<0.01*	8390.687	1	13763.135	<0.01*
Site	1.06	1	0.3	1.511	1	2.478	0.116
Mass	100.72	72	<0.05*	0.154	1	0.253	0.615
Site*Mass	2.98	5	0.7	0.518	1	0.849	0.357

As GZLM indicated sites differ significantly for certain T_{sel} variables, sites were further analysed separately to investigate the effect of sex, time of measurement and number of replicate by treating mean, minimum, maximum and range of T_{sel} as dependent variables and sex, time and replicate as categorical variables, with body mass as a continuous variable. All categories had no significant influence on mean, minimum, maximum or range of T_{sel} , except the time of measurement which significantly influenced the mean T_{sel} of ZNR individuals (Table 3.3).

Table 3.3: Generalized linear model for the effects of replicate, time and sex on mean, minimum, maximum and range of T_{sel} of ZNR and RNR individuals. Significant variables are indicated with *.

Zandvlei NR				Rietvlei NR			
Coefficient	x^2 estimate	df	p-value	Coefficient	x^2 estimate	df	p-value
<u>Mean T_{sel}</u>				<u>Mean T_{sel}</u>			
Intercept	87474.519	1	<0.01*	Intercept	225177.857	1	<0.01*
Replicate	3.715	2	>0.05	Replicate	2.963	2	>0.05
Sex	0.003	1	>0.05	Sex	3.403	1	>0.05
Time	21.084	9	<0.05*	Time	14.452	9	>0.05
<u>Maximum T_{sel}</u>				<u>Maximum T_{sel}</u>			
Intercept	272564.935	1	<0.01*	Intercept	439338.604	1	<0.01*
Replicate	2.381	2	>0.05	Replicate	3.551	2	>0.05
Sex	2.798	1	>0.05	Sex	0.882	1	>0.05
Time	9.826	9	>0.05	Time	13.569	9	>0.05
<u>Minimum T_{sel}</u>				<u>Minimum T_{sel}</u>			
Intercept	77688.841	1	<0.01*	Intercept	394262.767	1	<0.01*
Replicate	0.222	2	>0.05	Replicate	5.123	2	>0.05
Sex	2.585	1	>0.05	Sex	1.61	1	>0.05
Time	7.564	9	>0.05	Time	12.421	9	>0.05
<u>Range T_{sel}</u>				<u>Range T_{sel}</u>			
Intercept	39701.825	1	<0.01*	Intercept	119856.87	1	<0.01*
Replicate	1.439	2	>0.05	Replicate	0.028	2	>0.05
Sex	0.06	1	>0.05	Sex	0.197	1	>0.05
Time	6.531	9	>0.05	Time	7.273	9	>0.05

3.4.2 Critical thermal limits (CTL's)

GZLM showed that CTL's did not differ significantly between sites, sexes or mass recorded for individuals or the interaction of site*mass (Fig. 3.2; Table 3.4). The wide ranges of CTL of these sites (Table 3.5) indicate that *M. knoxii* has a wide thermal tolerance breadth.

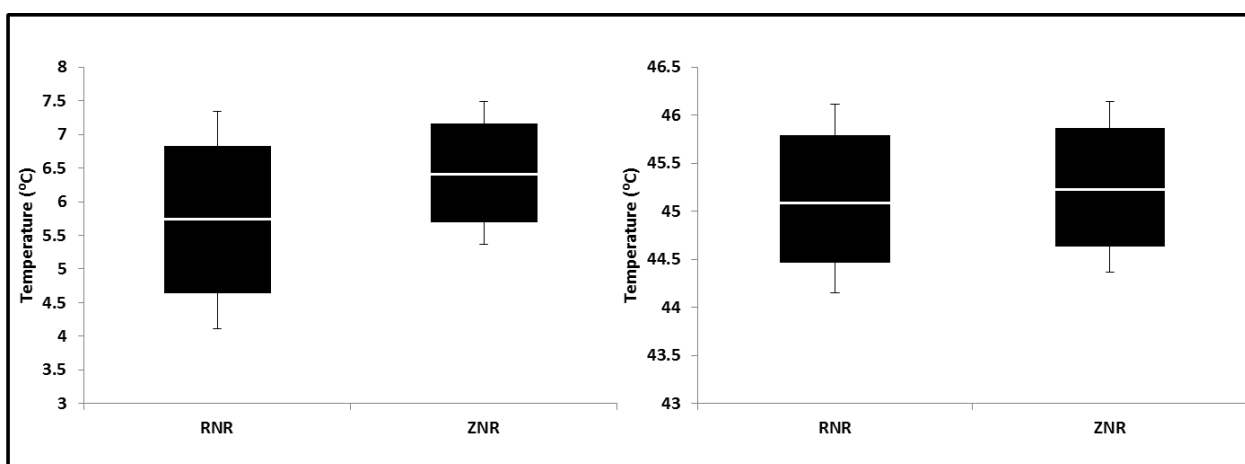

Figure 3.2: CT_{min} of RNR (n=16) and ZNR (n=9; left) and CT_{max} of RNR (n=16) and ZNR (n=9; right). Error bars °C ± s.e.m.

Table 3.4: Generalized linear model for the effects of site, sex, mass and the interaction of site*mass on CT_{min} (left) and CT_{max} (right). Significant variables are indicated with *.

CT _{min}				CT _{max}			
Coefficient	x ² estimate	df	p-value	Coefficient	x ² estimate	df	p-value
Intercept	14.847	1	0.07	Intercept	1224.442	1	<0.01*
Site	6.102	1	0.153	Site	6.022	1	0.596
Sex	1.657	1	0.898	Sex	8.332	1	0.896
Mass	2.091	1	0.945	Mass	1.684	1	0.921
Site*Mass	4.404	1	0.236	Site*Mass	0.824	1	0.644

Table 3.5: Mean, minimum, maximum and range of CTL's for both sites of *Merolus knoxii*. ±s.e.m.

Coefficient	Site	N	Mean	Minimum	Maximum	Range
CT _{min}	RNR	17	5.7±0.52	2.1	9.6	7.5±0.46
CT _{min}	ZNR	10	6.4±0.33	5.2	8.4	3.2±0.27
CT _{max}	RNR	17	45.1±0.31	42.6	47.6	4.9±0.32
CT _{max}	ZNR	10	45.3±0.27	44.1	46.4	2.3±0.25

3.4.3 Performance

Stamina measurements, distance and time travelled until exhaustion, and sprint speed were not affected by mass (Table 3.6). However, sex and the interaction of sex*mass influenced maximal sprint speed performance. The significantly larger males (mass: 2.78±0.22g; n=6) displayed a significantly higher maximal sprint speed (U_{max} : M: 280.02±5.98 m s⁻¹; F: 252.45±7.65 m s⁻¹) than females (mass: 2.5±0.18g; n=7) from ZNR. See Table 3.7 for values. A trade-off between sprint speed and stamina appear to occur with stamina optimized at lower test temperatures and sprint speed optimized at higher test temperatures (Fig. 3.3).

Table 3.6: GZLM of maximal stamina (distance and time) and maximal sprint speed performance. Significant values are indicated with *.

Coefficient	x ² estimate	df	p-value
<u>Distance U_{max}</u>			
Intercept	44.505	1	<0.01*
Mass	0.437	1	0.508
<u>Time U_{max}</u>			
Intercept	14.132	1	<0.01*
Mass	0.279	1	0.597
<u>Sprint Speed U_{max}</u>			
Intercept	5951.632	1	<0.01*
Mass	3.055	1	0.08
Sex	4.838	1	<0.05*
Sex*Mass	9.294	1	<0.05*

Table 3.7: Summary of U_{\max} (m s^{-1}) and T_{opt} ($^{\circ}\text{C}$) for sprint speed, distance and time travelled to exhaustion. All values (minimum, maximum, range and mean) \pm s.e.m.

Coefficient	Sprint Speed			Distance			Time	
	N	U_{\max}	T_{opt}	N	U_{\max}	T_{opt}	U_{\max}	T_{opt}
Mean	5	265.2 \pm 62	34.6 \pm 0.27	13	14.9 \pm 0.58	19.9 \pm 1.21	85.8 \pm 7.34	21.3 \pm 1.88
Minimum	5	225.5	33.1	13	14.0	17.6	58.9	18.5
Maximum	5	298.9	35.9	13	17.2	23.7	102.6	28.8
Range	5	73.4	2.8	13	3.2	3.1	43.7	10.3

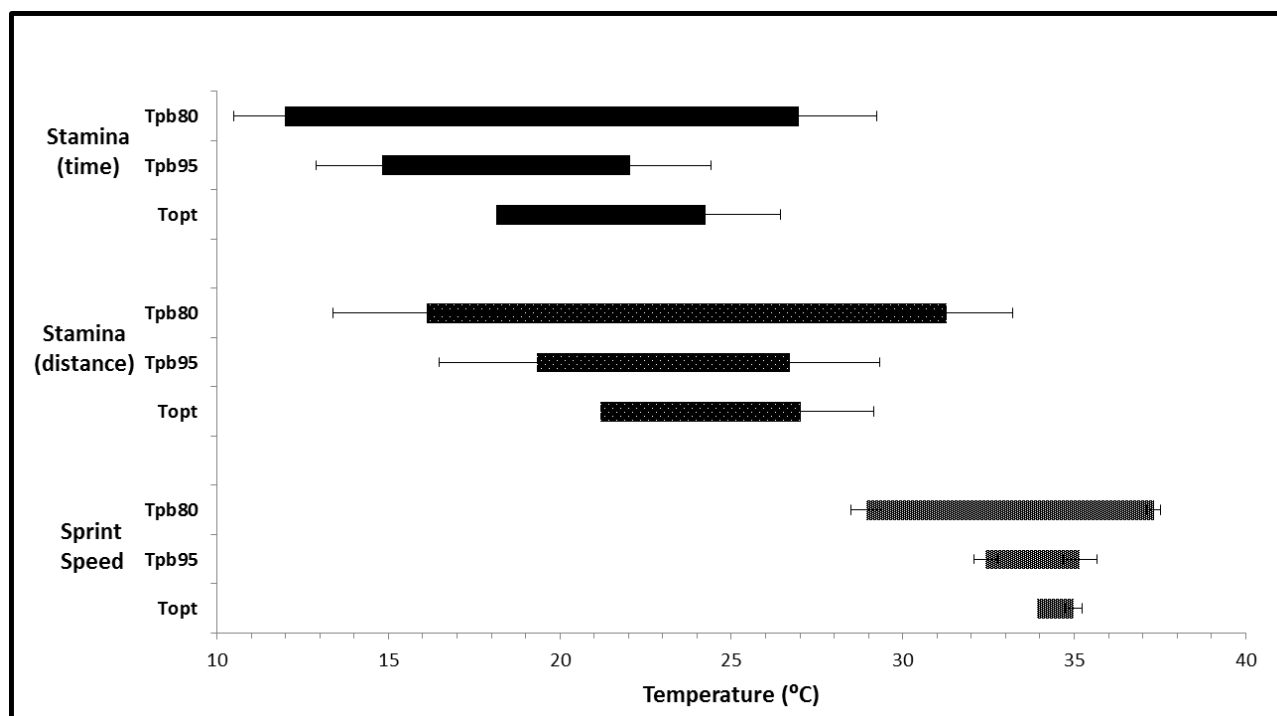

Figure 3.3: Optimal temperatures (T_{opt}) and performance breadths (T_{pb80} and T_{pb95}) of sprint speed and stamina traits of ZNR individuals.

3.4.4 Resting metabolic rate (RMR) and total evaporative water loss (TEWL)

Temperature significantly affected mean, minimum and maximum VCO_2 and VH_2O production (Fig. 3.4; Table 3.8), with VCO_2 and VH_2O production increasing as temperature increased. In addition, mean VCO_2 was influenced by mass, minimum and maximum VCO_2 differed significantly between sexes and the interaction of sex*mass significantly influenced minimum VCO_2 production. For VH_2O production, no other fixed factors influenced VH_2O production, except temperature. Interestin6+99gly, there was no significant difference of mean VCO_2 and VH_2O production between sites, even when mass and sex was included in the model interaction. In addition, variance of VCO_2 and VH_2O appear to increase with an increase in test temperatures (Fig. 3.5 & 3.6, respectively).

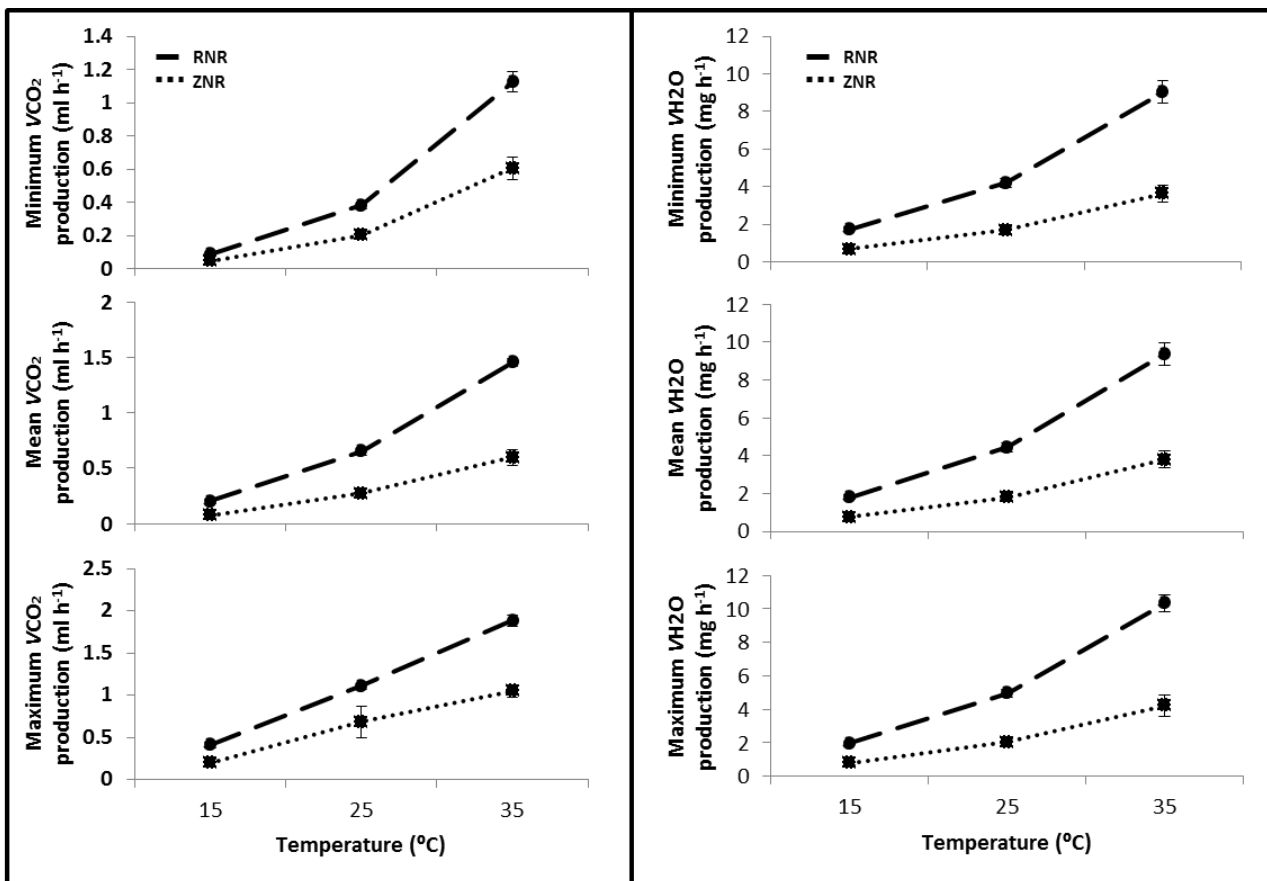

Figure 3.4: Minimum, mean and maximum VCO₂ and VH₂O production at the three test temperature (15°C, 25°C and 35°C). RMR and TEWL increase as temperature increases, with RMR and TEWL increasing more rapidly between 25-35°C than between 15-25°C for mean and minimum VCO₂ and VH₂O production and maximum VH₂O production.

Table 3.8: Results of GZLM for the effects of temperature, site, group, mass and the interactions thereof (site*mass, site*sex and sex*mass) on mean, minimum and maximum VCO₂ and VH₂O. Significance is indicated with a *.

VCO₂ production				VH₂O production			
Coefficient	x² estimate	df	p-value	Coefficient	x² estimate	df	p-value
<u>Mean VCO₂</u>				<u>Mean VH₂O</u>			
Intercept	0.086	1	0.769	Intercept	1.78	1	0.182
Sex	2.012	1	0.366	Sex	2.517	1	0.284
Temperature	385.871	2	<0.01*	Temperature	157.925	2	<0.01*
Site	2.086	1	0.149	Site	0.821	1	0.365
Mass	5.263	1	<0.05*	Mass	0.261	1	0.61
Site*Mass	1.942	1	0.163	Site*Mass	0.993	1	0.319
Site*Sex	1.215	1	0.27	Site*Sex	1.122	1	0.571
Sex*Mass	1.881	2	0.39	Sex*Mass	2.508	2	0.285
<u>Minimum VCO₂</u>				<u>Minimum VH₂O</u>			
Intercept	6.161	1	<0.05*	Intercept	1.594	1	0.207
Sex	7.892	1	<0.05*	Sex	2.458	1	0.293
Temperature	166.958	2	<0.05*	Temperature	146.52	2	<0.01*
Site	1.069	1	0.301	Site	0.79	1	0.374
Mass	0.284	1	0.594	Mass	0.279	1	0.597
Site*Mass	1.15	1	0.283	Site*Mass	0.965	1	0.326
Site*Sex	0.415	1	0.52	Site*Sex	1.326	1	0.515
Sex*Mass	8.238	2	<0.05*	Sex*Mass	2.444	2	0.295
<u>Maximum VCO₂</u>				<u>Maximum VCO₂</u>			
Intercept	11.074	1	<0.01*	Intercept	3.34	1	0.068
Sex	10.961	1	<0.01*	Sex	2.997	1	0.223
Temperature	155.591	2	<0.01*	Temperature	159.043	2	<0.01*
Site	0.975	1	0.324	Site	0.545	1	0.461
Mass	1.244	1	0.265	Mass	0.027	1	0.87
Site*Mass	0.708	1	0.4	Site*Mass	0.728	1	0.393
Site*Sex	0.614	1	0.433	Site*Sex	2.116	1	0.347
Sex*Mass	7.909	2	0.019	Sex*Mass	3.157	2	0.206

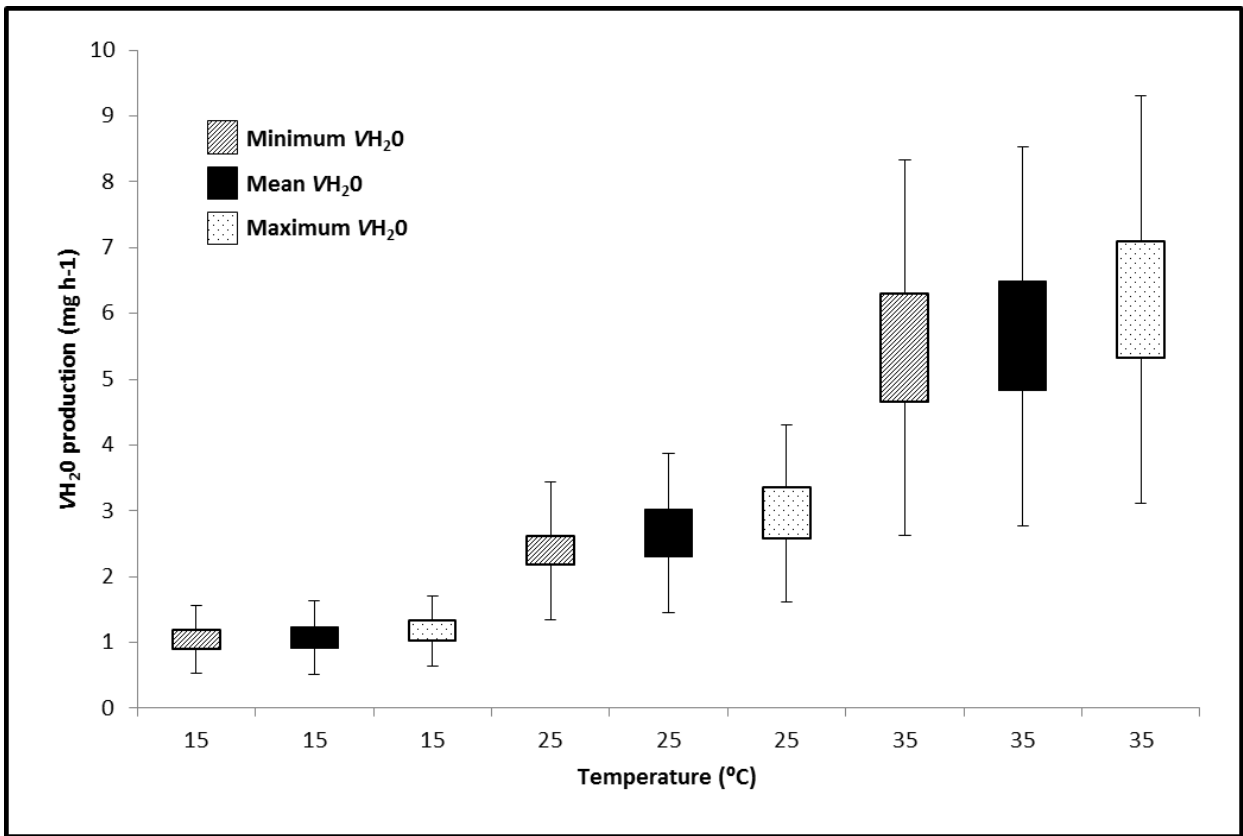

Figure 3.5: Temperature significantly influenced $V\dot{C}O_2$ production, minimum, mean and maximum RMR increasing with an increase in temperature.

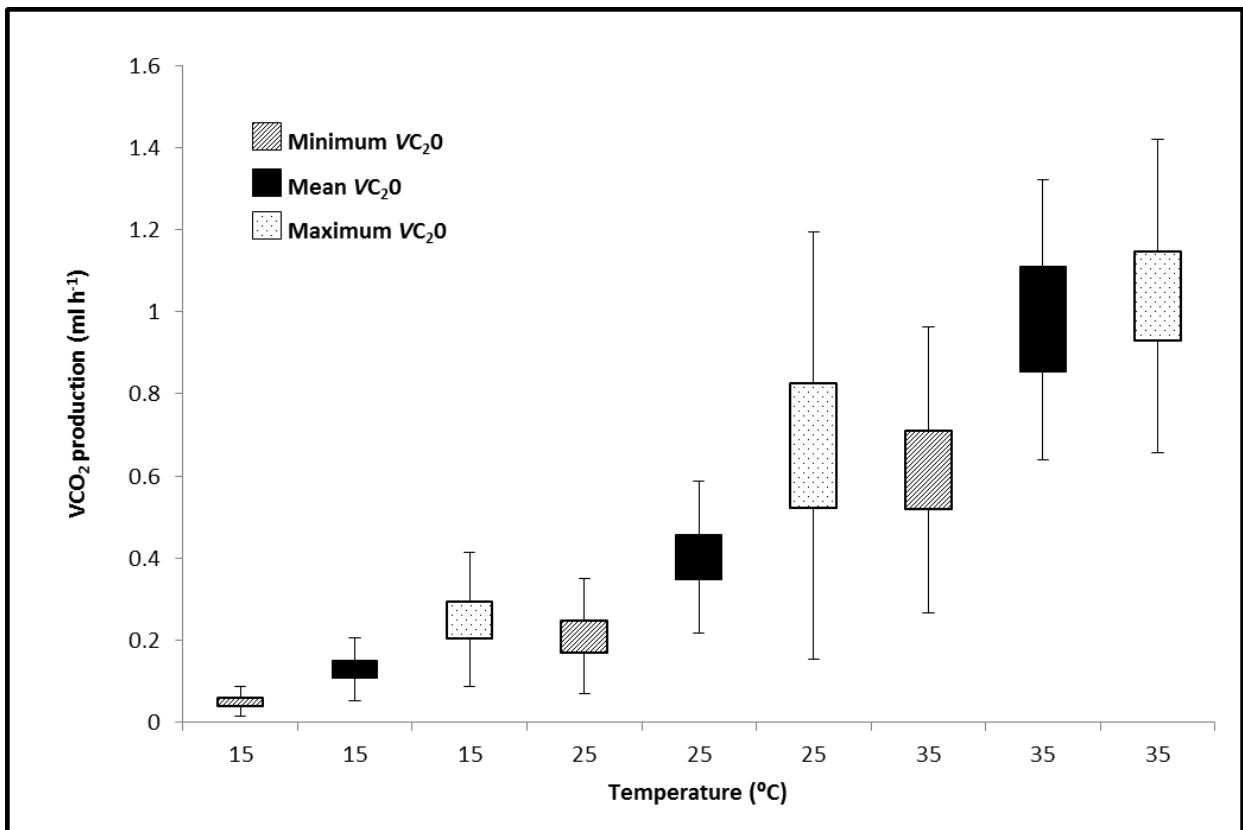

Figure 3.6: Temperature significantly influenced the rate of $V\dot{H}_2O$ production. TEWL increased significantly with an increase in temperature.

3.5 DISCUSSION

Individuals of *Meroles knoxii* tested from two sites sampled within the one genetic population of the southern clade clearly exhibited sensitivity of several thermal traits. The “preferred” or selected body temperature of a species is thought to reflect the approximate optimum range for fitness (Hertz *et al.*, 1993; Martin & Huey, 2008). Selected body temperatures (T_{sel}) of both sites revealed a narrow thermal range (RNR: T_{sel} range $3.3 \pm 0.08^\circ\text{C}$; ZNR T_{sel} range $2.2 \pm 0.04^\circ\text{C}$; Table 3.1), suggesting that *M. knoxii* could be a thermal specialist, maintaining its T_b within these relatively narrow thermal breadths. T_{sel} range and minimum T_{sel} did not differ significantly between sites. However, mean (RNR: mean $33.1 \pm 0.03^\circ\text{C}$, ZNR: mean $33.5 \pm 0.55^\circ\text{C}$) and maximum T_{sel} (RNR: max T_{sel} $33.9 \pm 0.02^\circ\text{C}$, ZNR: max T_{sel} $34.6 \pm 0.03^\circ\text{C}$) differed significantly (Table 3.2), suggesting mean and maximum T_{sel} could be more informative when considering small scale differences and mean T_{sel} relevant when extrapolating large scale estimates.

Selected body temperatures were similar to T_{sel} previously identified for other lacertid lizards (*Lacerta monticola*: 33.7°C ; *Lacerta vivipara*; 32.5°C ; Bauwens *et al.*, 1995). Sex and replicate did not differ significantly between sites (Table 3.3). However, measurements taken at different times during the day affected mean T_{sel} for ZNR individuals. Basking behaviour correlates with activity periods associated with seasons, for instance switching between bimodal and unimodal activity for summer and winter, respectively (Cloudsley-Thompson, 1991; Foa & Bertolucci, 2001). However, ZNR appears to prefer bimodal basking in the laboratory experiments, with most measurements within the central 50% of data captured occurring between 09:00-12:00 and 15:00-17:00. This finding should be correlated with field activity times and the availability of quality thermal microhabitats for summer and winter to verify whether this pattern is consistent with field observations and identify the underlying mechanisms (e.g. endogenous rhythm).

Critical thermal limits did not differ significantly between sites (Table 3.4) suggesting critical thermal limits are conserved between these sites, as expected. This could be due to ecological niche conservatism where species retain ancestral ecological characteristics (Wiens & Graham, 2005). In fact, upper critical thermal limits are thought to be highly conserved for lacertids (Bauwens *et al.*, 1995). These findings are consistent with CT_{max} recorded for other lacertid species (*Lacerta vivipara*: $40.5 \pm 0.31^\circ\text{C}$; *Acanthodactylus erythrurus*: $46.3 \pm 0.65^\circ\text{C}$; Bauwens *et al.*, 1995). In addition, this species does appear to show a broad thermal tolerance breadth as CT_{min} are quite low (RNR mean: $5.7 \pm 0.52^\circ\text{C}$; ZNR mean: $6.4 \pm 0.33^\circ\text{C}$) and CT_{max} relatively high (RNR mean: $45.1 \pm 0.31^\circ\text{C}$; ZNR mean: $45.3 \pm 0.27^\circ\text{C}$; Table 3.5). Also, as the CTL's appear to be conserved between sites and are considered the temperatures where ecologically relevant functions cease, these traits could be very informative when used in conjunction with SDM's. Considering that the margin between T_{sel} and CT_{max} is large ($>10^\circ\text{C}$; RNR mean T_{sel} : $33.1 \pm 0.03^\circ\text{C}$, ZNR mean T_{sel} : $33.5 \pm 0.55^\circ\text{C}$), overheating should not occur accidentally and lizards would probably retreat to

burrows before such possibilities arise, especially given the indication of their astute behavioural thermoregulatory capacity.

Temperature significantly affected resting metabolic rate (RMR) and total evaporative water loss (TEWL), with both traits increasing linearly with an increase in temperature (Fig. 3.4, Table 3.8). However, both RMR and TEWL did not differ significantly between sites, thereby rejecting the hypothesis that these thermal traits are variable at small spatial scales. Evaporative water loss (EWL) is known to be highly correlated with environment (arid/mesic; Shoemaer & Nagy, 1977; Mautz, 1982; Nagy, 1982). Given the climatic similarities of these mesic sites (both approximately 15-25°C in summer), the lack of differences of TEWL between these two sites suggests that TEWL could likely be more influenced by climatic environment than physiology, an interesting trait to consider for climate change effects of the central and northern clades (Chapter 2). For RMR, in addition to the effects of temperature, mean RMR was significantly affected by mass (Table 3.8). Not surprising, as metabolic rates are thought to depend on two interacting processes: the Boltzmann factor (describes temperature dependence of biochemical processes) and the quarter-power allometric relation (biological rates scaled with body size; Gillooly *et al.*, 2001). Interestingly, slope appears more gradual at lower temperatures (15-25°C), with steeper slopes occurring at the higher test temperatures (25-35°C, Fig. 3.4). Likewise, variance around the mean appears to increase at higher test temperatures relative to lower test temperatures for RMR and TEWL (Fig. 3.5 & Fig. 3.6, respectively), suggesting inter-individual variation is more likely to occur at higher temperatures and this variance could possibly buffer the adverse effects of increased temperatures.

As performance traits (sprint speed and stamina) were measured for ZNR only, comparisons of these traits with RNR was not possible. However, as hypothesized, a marked trade-off was observed with optimal sprint speed occurring at higher test temperatures and optimal stamina (both distance and time until exhaustion) occurred at relatively lower test temperatures (Fig 3.3). These findings correspond to what is considered the trade-off for ambush predation (Vanhooydonck *et al.*, 2014). In addition, it supports the implication that certain design traits required to maximize performance of different traits are unlikely to be merged in one phenotype (Vanhooydonck *et al.*, 2001). Optimal sprint speed temperatures ($34.6 \pm 0.27^\circ\text{C}$) corresponded with T_{sel} range ($32.3 \pm 0.055^\circ\text{C}$ - $34.6 \pm 0.03^\circ\text{C}$) for ZNR individuals, suggesting T_{sel} correspond to temperatures that maximize *M. knoxii*'s physiological requirements (Castilla *et al.*, 1999), such as ambush predation. In addition, larger males displayed a significantly higher maximal sprint speed than females (Table 3.6). The larger body sizes could result in longer hind-limb lengths, which has been associated with greater sprint speed capacity (Garland, 1985; Losos, 1990; Bauwens *et al.*, 1995).

Although these experiments cannot indiscriminately reflect the complex interactions experienced by *M. knoxii* in the field, it does show several trends worth recognizing as factors that could

contribute to the survival probability of the species. The T_{sel} range which reflected narrow optimal breadth, is likely to affect activity periods and in turn potentially affecting foraging, reproduction and increased probabilities of predation. Wide thermal tolerances displayed by CTL's suggest that this genetic population of *M. knoxii* could buffer climate warming effects through behavioural means. These findings emphasize the need to incorporate physiological and behavioural traits to estimate ectotherm responses to climate change. Other factors that could greatly contribute to our understanding of this species physiological capacity would be seasonal variation of these thermal traits, assimilation/digestion potential under differing thermal regimes and whether thermal profiles shift due to different life stages. More importantly, these thermal traits should be incorporated into SDM's in an effort to more accurately predict *M. knoxii*'s possible response to climate change.

3.6 REFERENCES

- Angilletta, M.J., Jr. 2001. Variation in metabolic rate between populations of a geographically widespread lizard. *Physiological and Biochemical Zoology* **74**: 11-21.
- Angilletta, M.J., Niewiarowski, P.H., Navas, C.A. 2002. The evolution of thermal physiology in ectotherms. *Journal of Thermal Biology* **27**: 249–268.
- Angilletta, M.J., Wilson, R.S., Navas, C.A., James, R.S. 2003. Trade-offs and the evolution of thermal reaction norms. *Trends in Ecology and Evolution* **18**: 234-240.
- Angilletta, M.J. 2009. Thermal sensitivity. *Thermal adaptation: a theoretical and empirical synthesis*. Oxford University Press, pp. 35-87.
- Ashton, K. G., & Feldman, C. R. 2003. Bergmann's Rule in non-avian reptiles: Turtles follow it, lizards and snakes reverse it. *Evolution* **57**: 1151-1163.
- Aubret, F. & Shine, R., 2010. Thermal plasticity in young snakes : how will climate change affect the thermoregulatory tactics of ectotherms? *The Journal of Experimental Biology* **213**: 242-248.
- Autumn, K., De Nardo, D.F. 1995. Behavioral thermoregulation increases growth rate in a nocturnal lizard. *Journal of Herpetology* **29**: 157-162.
- Ayers, D. Y., & Shine, R. 1997. Thermal influences on foraging ability: body size, posture and cooling rate of an ambush predator, the python *Morelia spilota*. *Functional Ecology* **11**: 342–347
- Barlett, P.N., Gates, D.M. 1967. The energy budget of a lizard on a tree trunk. *Ecology* **48**: 315-322.
- Bartholomew, G.A. 1966. A field study of temperature relations in the Galapagos marine iguana.

Copeia **2**: 241-250.

- Bauwens, D., Garland, T., Castilla, A.M., Van Damme, R. 1995. Evolution of sprint speed in lacertid lizards: morphological, physiological and behavioral covariation. *Evolution* **49**: 848–863.
- Blouin-Demers, G., Nadeau, P. 2005. The cost-benefit model of thermoregulation does not predict lizard thermoregulatory behavior. *Ecology* **86**: 560-566.
- Bogert, C.M. 1959. How reptiles regulate their body temperatures. *Scientific American* **200**: 105-120.
- Bonino, M.F., Azocar, D.L.M., Schulte, J.A., Abdala, C.S., Cruz, F.B. 2015. Thermal sensitivity of cold climate lizards and the importance of distributional ranges. *Zoology* ZOOL-25443.
- Brown, J.H., Stevens, G.C., Kaufman, D.M., 1996. The geographic range: size, shape, boundaries and internal structure. *Annual Review of Ecology and Systematics* **27**: 597-623.
- Castilla, A.M., Van Damme, R., Bauwens, D. 1999. Field body temperatures, mechanisms of thermoregulation and evolution of thermal characteristics in lacertid lizards. *Croatian Natural History Museum* **8**: 253-274.
- Clusella-Trullas, S., Terblanche, J.S., van Wyk, J.H., Spotila, J.R. 2007. Low repeatability of preferred body temperature in four species of Cordylid lizards: Temporal variation and implications for adaptive significance. *Evolutionary Ecology* **21**: 63-79.
- Clusella-Trullas, S., Chown, S. 2014. Lizard thermal trait variation at multiple scales: a review. *Journal of Comparative Physiology B* **184**: 5-21.
- Cooper, W.E., Whiting, M.J. 1999. Foraging modes in lacertid lizards from southern Africa. *Amphibia-Reptilia* **20**: 299-311.
- Cowles, R.B., 1965. Hyperthermia, aspermia, mutation rates and evolution. *The Quarterly Review of Biology* **40**: 341-367.
- Cowles, R.B., Bogert, C.M. 1944. A preliminary study of the thermal requirements of desert reptiles. *Bulletin of the American museum of Natural History* **83**: 261-296.
- Cloudsley-Thompson, J.L. 1991. Ecophysiology of desert arthropods and reptiles. Springer-Verlag, Berlin, Heidelberg.
- DeWitt, C.B. 1971. Postural mechanisms in the behavioral thermoregulation of a desert lizard *Dipsosaurus dorsalis*. *Journal of Physiology* **63**: 242-245.
- Dillon, M.E., Wang, G., Huey, R.B. 2010. Global metabolic impacts of recent climate warming.

Nature **467**: 704–706.

- Duckett, P.E., Wilson, P.D. & Stow, A.J., 2013. Keeping up with the neighbours: Using a genetic method of dispersal and species distribution modelling to assess the impact of climate change on an Australian arid zone gecko (*Gehyra variegata*). *Diversity and Distribution* **19**: 964–976.
- Duvdevani, I., Borut, A. 1974. Mean body temperature and heat absorption in four species of *Acanthodactylus* lizards (Lacertidae). *Herpetologica* **30**: 176-181.
- Edwards, S. Vanhooydonck, B., Herrel, A., Measey, G.J., Tolley, K.A. 2012. Convergent evolution associated with habitat decouples phenotype from phylogeny in a clade of lizards. *PLoS ONE* **7**: e51636.
- Foà, A., Bertolucci, C. 2001. Temperature cycles induce a bimodal activity pattern in ruin lizards: masking or clock-controlled event? A seasonal problem. *Journal of biological rhythms* **16**: 574–584.
- Garland, T. 1985. Ontogenetic and individual variation in size, shape and speed in the Australian agamid lizard *Amphibolurus nuchalis*. *Journal of Zoology* **207**: 425–439.
- Gaston, K.J. 2003. The structure and dynamics of geographic ranges. Oxford University Press, Oxford.
- Gillooly, J.F., Brown, J.H., West, G.B., Savage, V.M., Charnov, E.L. 2001. Effects of size and temperature on metabolic rate. *Science* **293**: 2248-2251.
- Grigg, J.W., Buckley, L.B. 2013. Conservatism of lizard thermal tolerances and body temperatures across evolutionary history and geography. *Biology Letters* **9**: 20121056.
- Gunderson, A.R., Stillman, J.H. 2015. Plasticity in thermal tolerance has limited potential to buffer ectotherms from global warming. *Proceedings of the Royal Society B: Biological sciences* **282**: 20150401.
- Gvoždík, L., 2012. Plasticity of preferred body temperatures as means of coping with climate change? *Biology Letters* **8**: 262-265.
- Heath, J.E. 1965. Temperature regulation and diurnal activity in horned lizards. *University of California Press, Berkeley* **64**: 97-136.
- Herrel, A., James, R.S., Van Damme, R. 2007. Fight versus flight: physiological basis for temperature-dependent behavioral shifts in lizards. *Journal of Experimental Biology* **210**: 1762–1767.
- Hertz, P.E., Huey, R.B., Nevo, E. 1983. Homage to Santa Anita: thermal sensitivity of sprint speed

in agamid lizards. *Evolution* **37**: 1075–1084.

- Hertz, P.E., Huey, R.B., Stevenson, R.D. 1993. Evaluating temperature regulation by field-active ectotherms: the fallacy of the inappropriate question. *The American Naturalist* **142**: 796-818.
- Hochachka, P.W., Somero, G.N. 2002. Biochemical adaptation: mechanism and process in physiological evolution. Oxford University Press, New York.
- Huey, R.B. 1974. Behavioral thermoregulation in lizards: Importance of associated costs. *Science* **184**: 1001–1003.
- Huey, R.B., Slatkin, M. 1976. Cost and benefits of lizard thermoregulation. *The Quarterly Review of Biology* **51**: 363-384.
- Huey, R.B., Hertz, P.E. 1984. Is a jack-of-all-temperatures a master of none? *Evolution* **38**: 441–444.
- Huey, R.B., Dunham, A.E., Overall, K.L., Newman, R.A. 1990. Variation in locomotor performance in demographically known populations of the lizard *Sceloporus merriami*. *Physiological Zoology* **63**: 845–872.
- Huey, R.B., Losos, J.B., Moritz, C. 2010. Are lizards toast? *Science* **328**: 832–833.
- Kearney, M., Porter, W.P. 2004. Mapping the fundamental niche: physiology, climate and the distribution of a nocturnal lizard. *Ecology* **85**: 3119–3131.
- Kearney, M., Porter, W.P., Williams, C., Ritchie, S., Hoffman, A.A. 2009. Integrating biophysical models and evolutionary theory to predict climatic impacts on species' ranges: the dengue mosquito *Aedes aegypti* in Australia. *Functional Ecology* **23**: 528-538.
- Kingsolver, J.G., Wood, H.A. 1997. Thermal sensitivity of growth and feeding in *Manduca sexta* caterpillars. *Physiological and Biochemical Zoology* **70**: 631–638.
- Li, H., Mao, L., Shi, L., Ji, X. 2010. Many-lined sun skinks (*Mabuya multifasciata*) shift their thermal preferences downwards when fasted. *Asian Herpetological Research* **1**: 36–39.
- Losos, J.B. 1990. The evolution of form and function: Morphology and locomotor performance in West Indian Anolis lizards. *Evolution* **44**: 1189–1203.
- Lutterschmidt, W.I., Hutchison, V.H. 1997. The critical thermal maximum: history and critique. *Canadian Journal of Zoology* **75**: 1561–1574.
- Martin, T.L. & Huey, R.B. 2008. Why “suboptimal” is optimal: Jensen’s inequality and ectotherm thermal preferences. *The American Naturalist* **171**: E102–E118.

- Mautz, W.J. 1982. Correlation of both respiratory and cutaneous water losses of lizards with habitat aridity. *Journal of Comparative Physiology* **149**: 25-30.
- McConnachie, S., Alexander, G.J. & Whiting, M.J., 2009. Selected body temperature and thermoregulatory behavior in the sit-and-wait foraging lizard *Pseudocordylus melanotus melanotus*. *Herpetological Monographs* **23**: 108–122.
- Nagy, K.A. 1982. Field studies of water relations. *Biology of the Reptilia*. Editors: Gans, C., Pough, F.H. Academic Press, London, pp. 483-501.
- Pianka, E.R. 1978. Reptilian species diversity. *Biology of the Reptilia*. Editors: Gans, C., Tinkle, D.W. Academic Press, London, New York, **7**: 1-34.
- Porter, W.P., Mitchell, J.W., Beckman, W.A., DeWitt, C.B. 1973. Behavioral implications of mechanistic ecology. Thermal and behavioral modeling of desert ectotherms and their microenvironment. *Oecologia* **13**: 1-54.
- Rome, L.C., Stevens, E.D., John-Alder, H.B. 1992. The influence of temperature and thermal acclimation on physiological function. *Environmental Physiology of the Amphibians*. Editors: Feder, M.E., Burggren, W.W. The University of Chicago Press, Chicago, pp. 183-205.
- Rummery, C., Shine, R., Houston, D.L., Thompson, M.B. 1994. Thermal biology of the Australian forest dragon, *Hypsilurus spinipes* (Agamidae). *Copeia* **1994**: 818–827.
- Sartorius, S.S., do Amaral, J.P.S. Durtsche, R.D., Deen, C.M., Lutterschmidt, W. I. 2002. Thermoregulatory accuracy, precision and effectiveness in two sand-dwelling lizards under mild environmental conditions. *Canadian Journal of Zoology* **80**: 1996-1976.
- Shoemaker, V.H. Nagy, K.A. 1977. Osmoregulation in amphibians and reptiles. *Annual Review of Physiology* **39**: 449-471.
- Sinervo, B., Mendez-de-la-Cruz, F., Miles, D.B., Heulin, B., Bastiaans, E., 2010. Erosion of lizard diversity by climate change and altered thermal niches. *Science* **328**: 894–899.
- Spotila, J.R., Berman, E.N. 1976. Determination of skin resistance and the role of the skin in controlling water loss in amphibians and reptiles. *Comparative Biochemistry and Physiology Part A: Physiology* **55**: 407-411.
- Templeton, J.R. 1970. Reptiles. *The Comparative Physiology of Thermoregulation*. Editor: Whittow, G.C. Academic Press, New York, London **1**: 167-221.
- Van Berkum, F.H. 1988. Latitudinal patterns of the thermal sensitivity of sprint speed in lizards. *The American Naturalist* **132**: 327-343.

- Van Damme, R., Bauwens, D., Verheyen, R.F. 1986. Selected body temperatures in the lizard *Lacerta vivipara*: variation within and between populations. *Journal of Thermal Biology* **11**: 219-222.
- Vanhooydonck, B., Van Damme, R., Aerts, P. 2001. Speed and stamina trade-off in lacertid lizards. *Evolution* **55**: 1040–1048.
- Vanhooydonck, B., James, R.S., Tallis, J., Aerts, P., Tadic, Z., Tolley, K.A., Measey, G.J., Herrel, A. 2014. Is the whole more than the sum of its parts? Evolutionary trade-offs between burst and sustained locomotion in lacertid lizards. *Proceedings of the Royal Society B: Biological sciences* **281**: 20132677.
- Visser, M.E. 2008. Keeping up with a warming world: assessing the rate of adaptation to climate change. *Proceedings of the Royal Society B: Biological Sciences* **275**: 649–659.
- Whitton, F.J.S., Purvis, A., Orne, C.D.L., Olalla-Tarraga, M.A. 2012. Understanding global patterns in amphibian geographic range size: does Rapoport rule? *Global Ecology and Biogeography* **21**: 179–190.
- Wiens, J.J., Graham, C.H. 2005. Niche conservatism: integrating evolution, ecology and conservation biology. *Annual Review of Ecology, Evolution and Systematics* **36**: 519-539.
- Withers, P.W. 1992. *Comparative Animal Physiology*. Saunders College Publishers, p. 95.

GENERAL CONCLUSION

A species ability to adapt to rapidly changing thermal landscapes is paramount to species survival and persistence. Mechanistic variables, such as genetic diversity and thermal performance parameters, could shed light on these abilities when used in conjunction with species distribution modelling. Recent studies have realized the benefit of this approach. Unfortunately, these studies are still few and far between. Identifying potential historic and contemporary environmental influences and thermal profiles of species would provide better estimate to predict extinction risks and potential future distributions of lizards globally.

This thesis demonstrates the potential phylogeographic occurrence of *Meroles knoxii*, suggesting the three clades identified could be considered distinct evolutionary significant units when conducting species distribution modelling. Given the complex climatic environment potentially contributing to the phylogeographic pattern, modelling this species as such could simplify and possibly improve response predictions of this species. As historic sea level transgressions have been implicated as a process potentially affecting this pattern, future sea level changes should be taken into account. In addition, the possible influence of the winter rainfall zone should be noted for dispersal potential east. Body size differences suggest local adaptation, proposing species responses could differ between clades and thermal profiles are lacking for northern and central clade populations. Additional research should identify the full extent of the northern and central clades with fine scale sampling conducted in the Draaihoek area. In addition, micro-satellite data could elucidate gene flow at a much finer scale.

Thermal sensitivity of *M. knoxii* is apparent, with certain traits considered variable and other conserved between two sites within the southern population. Critical thermal limits, resting metabolic rate and total evaporative water loss were conserved traits between these two sites and should be considered for species distribution modelling. The variance of selected body temperatures between sites tell a cautionary tale, where field behavioural measurements and microhabitat selection should be used in conjunction with laboratory experiments to find this species' optimal thermal niche. As selected body temperatures followed optimal sprinting capacity of ZNR individuals, results indicate basking temperatures that optimize performance needs. In addition, the trade-off observed between sprint speed and stamina suggests sprint speed temperatures to be more informative for climate change predictions of this ambush predator. Future research should incorporate thermal niche availability in a heterogeneous environment and aim to determine whether the thermal trait variability/conservatism is reflected in the northern and central clade.

APPENDICES

Appendix 1.1: DNA salt extraction protocol (©Vieites, Berkeley USA)

1. Tissue+410µl extraction buffer + 2% SDS (80µl 10% SDS) + 10µl Proteinase K (10mg/ml)
2. Incubate 55 °C or 37 °C overnight
3. 5 minutes 13000rpm centrifuge, pipette transfer supernatant in a new vessel +180 µl NaCl.
Mix it by turning Eppi 50 times.
4. 5 minutes 13000rpm centrifuge, pipette transfer supernatant quickly in a new vessel + 420µl cooled Isopropanol (mix it gently).
5. Leave samples in freezer for 24hours at -40 °C.
6. 5 minutes 13000rpm centrifuge, discard supernatant. Add 250 µl 80% Ethanol for washing.
Mix it by turning Eppi 50 times.
7. 5 minutes 13000rpm centrifuge, discard supernatant. Add 250 µl 80% Ethanol for washing.
Mix it by turning Eppi 50 times.
8. Remove alcohol completely, dry pellet with open lids on heat block until the alcohol has evaporated.
9. Dilute DNA in 100-200 µl ddH₂O and keep at room temperature overnight.
10. Freeze -20 °C or use it.

Appendix 1.2: Experimental set-up of the critical thermal limits trials conducted on *Meroles knoxii*.

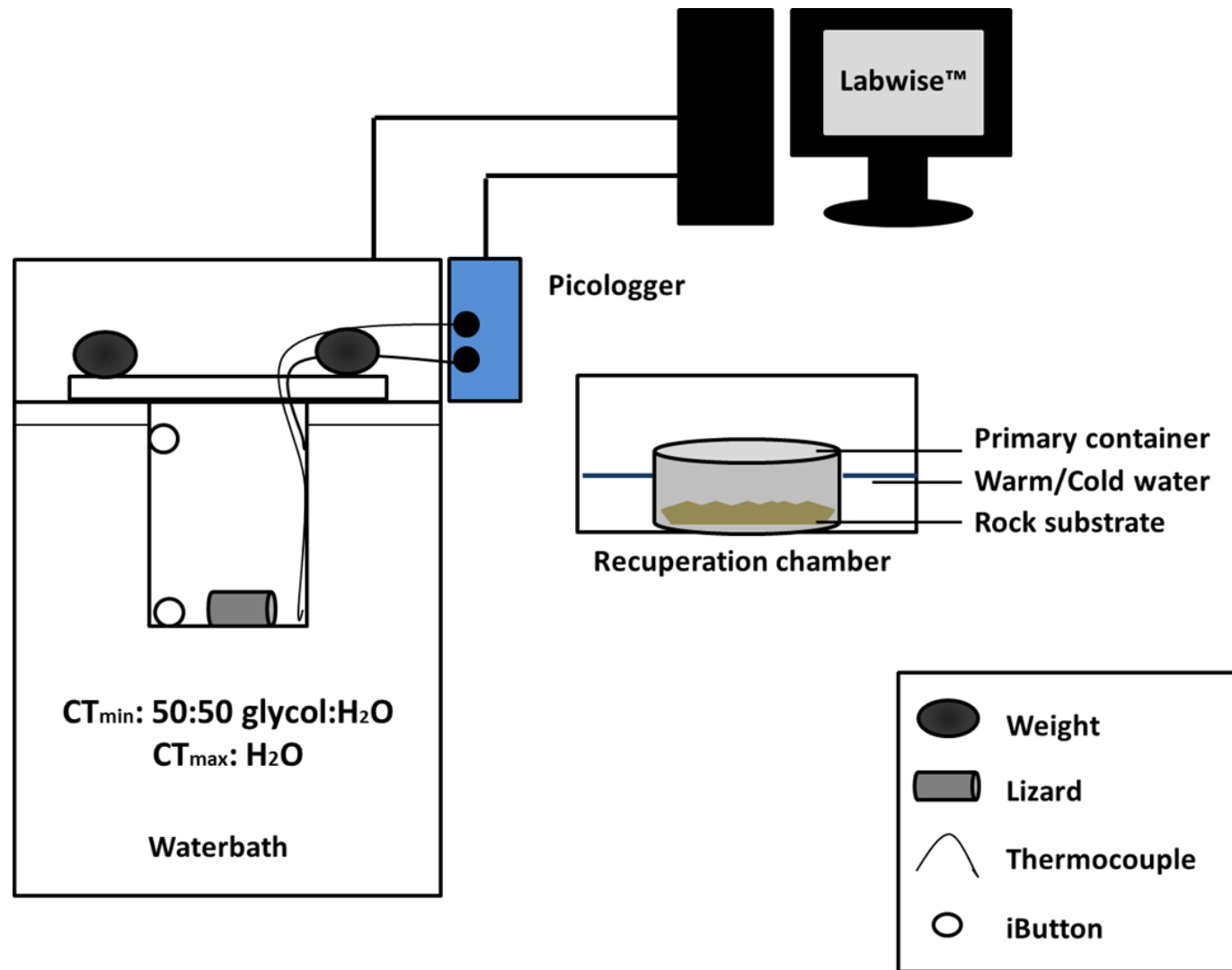

Appendix 1.3: Sprint speed racing track (left) and stamina racing track (right) used to conduct performance trials for *Meroles knoxii*.

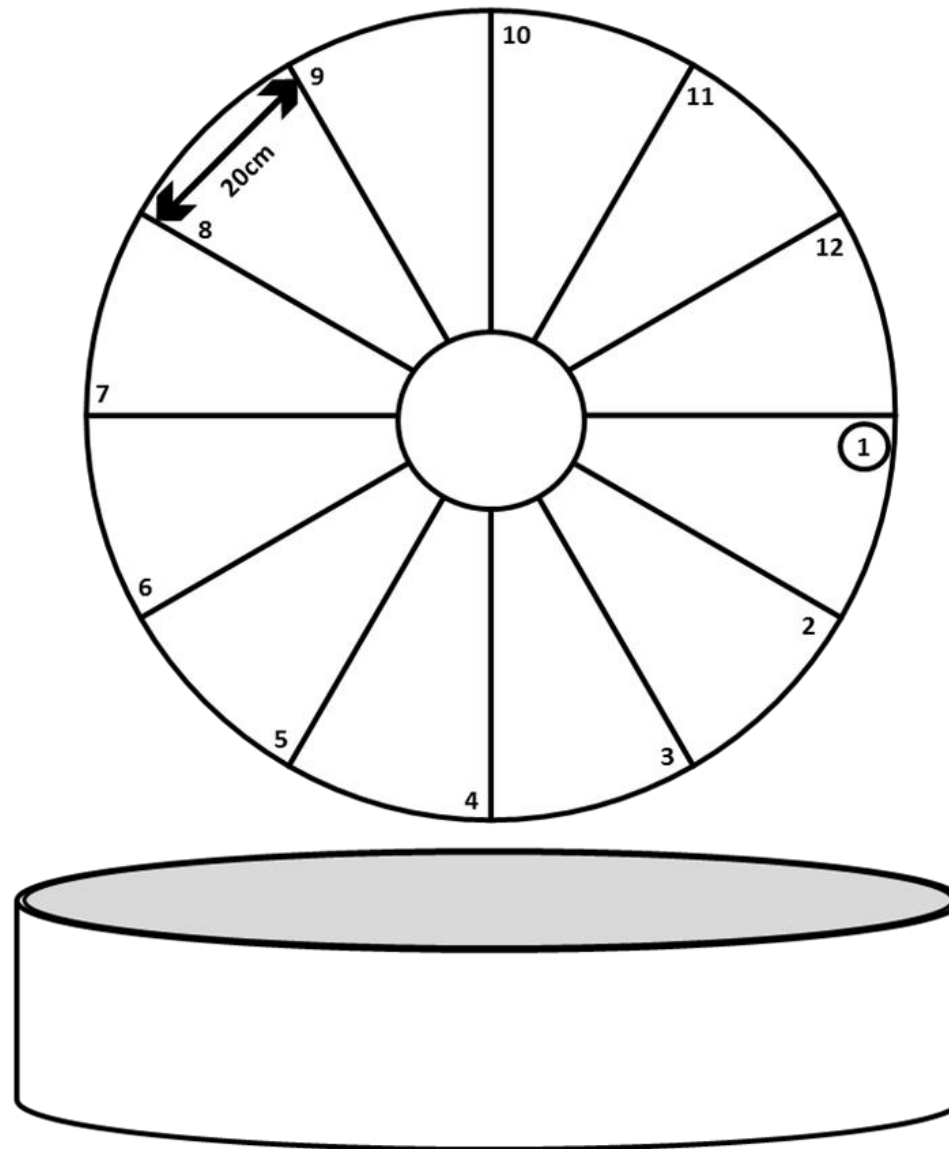
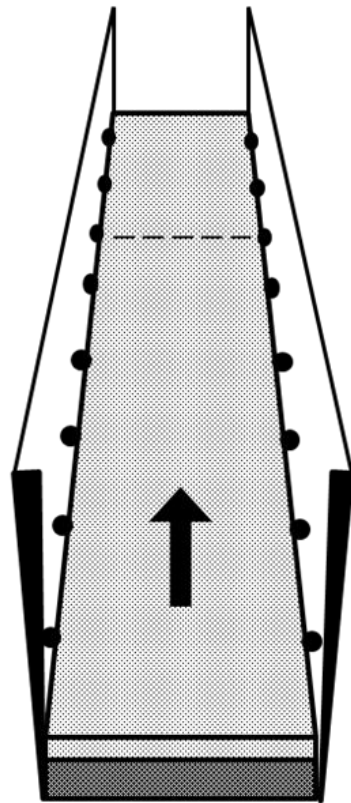
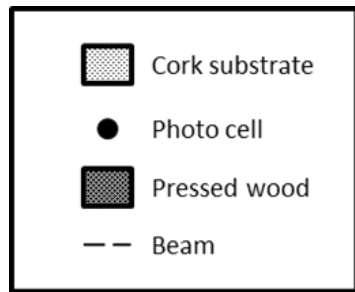

Appendix 1.4: Experimental set-up of flow through respirometry measurements to determine RMR and TEWL of *Meroles knoxii*.

